

1	ROBINETI CU SFERA DIN ALAMA APĂ ȘI GAZ	
2	RACORDURI DE COMPRESIE PENTRU TUB MULTISTRAT "AL-COBRAPEX" - SERIA 1600	
3	RACORDURI DE PRESARE PENTRU TUB MULTISTRAT "AL-COBRAPEX" - SERIA 1650	
4	RACORDURI DE COMPRESIE PENTRU TUB "COBRAPEX" - SERIA 1400	
5	RACORDURI DE PRESARE PENTRU TUB "COBRAPEX" - SERIA 1700	
6	RACORDURI DE COMPRESIE PENTRU TUB DIN CUPRU CU INEL DIN ALAMĂ - SERIA 1000/1100	
7	RACORDURI UNIVERSALE PENTRU CUPRU, PEX SI TUB MULTISTRAT - SERIA WATERBLOCK	
8	TUB MULTISTRAT "AL-COBRAPEX" SI POLIETILENA RETICULATA "COBRAPEX"	
9	RACORDURI DE COMPRESIE CU O-RING DIN ALAMĂ PENTRU TUBURI DIN PE/PEHD/PEX - SERIA 3460	
10	RACORDURI GENERALE DIN ALAMA - SERIA 1500	
11	COLECTOARE DE DISTRIBUTIE	
12	ROBINETI PENTRU RADIATOARE	
13	SISTEME DE INCALZIRE PRIN PARDOSEALA	
14	TERMOREGLARE	
15	COMPONENTE PENTRU CENTRALE TERMICE/INCALZIRE	
16	SISTEM SOLAR TERMIC CU CIRCULATIE FORTATA PENTRU PRODUCEREA APEI CALDE MENAJERE	

“Oamenii noștri, competențele și experiența lor
au fost întotdeauna principalul atu al companiei noastre.
Aceasta este valoarea cheie care ne permite să înțelegem nevoile
clienților noștri italieni, precum și ale clienților noștri
din întreaga lume, furnizându-le servicii și produse
care sunt întotdeauna specifice și inovatoare”.

Președintele

Giuliano Gnutti





Gruppo Gnutti este una dintre principalele realitati ale antreprenoriatului din Brescia inca din anii '50, cu o activitate bine inradacinata in teritoriu. Un grup de firme care detine intregul lant tehnico-productiv si transforma materia prima intr-un produs finit. Un acord perfect intre Traditie, Profesionalism, Calitate, Tehnologie si Know-How pentru a putea oferi cel mai bun serviciu in fiecare zi. Gruppo Gnutti s-a nascut din dezvoltarea si cresterea Gnutti Cirillo S.p.A.



Tiemme Raccorderie a fost înființată în anii '80 ca o companie care produce și distribuie fittinguri, supape din alama și tevi. În 1994 s-a alăturat „Gruppo Gnutti”, anul în care compania a cunoscut o schimbare radicală. Anii 2000 reprezintă o fază de creștere și evoluție ulterioară a companiei prin dezvoltarea sistemelor integrate în domeniul încălzirii. În 2012, la sediul din Castegnato a luat naștere “Tiemme Lab”, laboratorul termotehnic inovator al Tiemme. Filialele din Spania, Grecia și România doresc să răspundă unei piețe din ce în ce mai extinse și mai exigente, îndreptând privirea companiei către o perspectivă de internaționalizare.



Societatea „**Valvosanitaria Bugatti**” este creată în anul 1948 în localitatea Lumezzane (BS) bazându-și propria activitate în producerea robinetilor. În timp activitatea societății se specializează în producerea robinetilor cu sfera, iar în anul 1984 societatea își schimbă sediul în localitatea Castegnato. Societatea este dotată cu un depozit ce pune la dispoziție o gamă amplă de produse asigurând organizarea eficientă a livrărilor și completarea stocurilor. În anul 2023 societatea „Valvosanitaria Bugatti” intră în componența „Gruppo Gnutti”. La ora actuală este o societate ce își are locul său pe piața internațională în producerea robinetilor cu sfera pentru apă și gaz, a racordurilor, a bateriilor sanitare și a componentelor pentru instalațiile de încălzire.



Gnutti Cirillo S.p.A. fondată în 1951 de Cirillo Gnutti ca firmă mecanică pentru construcția de scule și matrite, și astăzi este lider mondial în domeniul stantării la cald și a prelucrării mecanice a alamei și a altor metale neferoase. Gnutti Cirillo S.p.A. a atins un nivel înalt de competență tehnică ce îi permite să satisfacă orice solicitare datorită autosuficienței în lanțul de producție. Începând de la proiectare, trecând prin construcția sculelor și uneltelor, stantarea la cald a alamei, prelucrări, tratamente de suprafață, montaje automate până la ambalarea produsului finit; toate realizate în cadrul grupului cu posibilitatea de personalizare în conformitate cu specificațiile clientului. Uzina Odolo (BS) a fost adăugată sediului istoric din Lumezzane (BS) în 2000.



De-a lungul anilor, procesul de internaționalizare a grupului a continuat odată cu înființarea **Metal Forming Technology Inc.** Situată în statul Michigan (SUA), MFT a atins standarde înalte de eficiență în producția de articole din alama stantată la cald și prelucrate conform specificațiilor clientului. Compania acționează, de asemenea, ca și centru logistic și de asistență pentru clienții Gnutti Cirillo S.p.A. din piața nord-americană și canadiană.



EMC Component este o companie fondată în 2011, specializată în proiectarea, producerea și comercializarea de accesorii pentru transformatoare electrice de distribuție și putere. Toate produsele „EMC” au la bază o idee și o necesitate specifică a pieței de desfacere. În interiorul „EMC” aceste produse sunt proiectate, devin prototipuri, sunt testate și în cele din urmă realizate; prin urmare sunt fabricate 100% “Made in Italy”, ce constituie o garanție de maximă calitate și fiabilitate.



**TIEMME**
ORIGINAL ITALIAN TRADEMARK 



UNI EN ISO 9001:2015



SISTEMA DI GESTIONE
CERTIFICATO

Tiemme Raccorderie® S.p.A. este astazi o societate lider in sectorul producerii si comercializarii de articole hidro-termo-sanitare; capacitatea sa de dezvoltare se observa, cu precadere, dupa intrarea sa in Grupul Gnutti, din anul 1994.

Societatea isi are sediul in Castegnato, in provincia Brescia si isi desfasoara activitatea in doua cladiri: una cu o suprafata de 7.000 mp. acoperiti, in care se afla birourile si unde se desfasoara o parte din activitatea de productie si una de 15.000 mp.in care se afla depozitele si productia pentru tubul din polietilena reticulata PEX.

Sistemul de Calitate Tiemme Raccorderie S.p.A. este instrumentul ce garanteaza clientilor sai produse si servicii care sa satisfaca expectativele acestora, atat in ceea ce priveste calitatea produselor, cat si in ceea ce priveste punctualitatea in onorarea comenzilor; societatea este in plina si continua imbunatatire a calitatii serviciilor, avand in vedere si respectul pentru siguranta mediului ambiant.

In anul 1999, Tiemme Raccorderie S.p.A. a obtinut certificarea ISO 9002 pentru propriul sistem de calitate, iar in anul 2003 a obtinut certificarea ISO 9001, ca o consecinta naturala a politicii firmei pentru calitate totala si de atingere a excelentei in domeniu.

Produsele Tiemme Raccorderie S.p.A. sunt controlate si recunoscute in intreaga lume de peste 70 din cele mai prestigioase organizatii de omologare.

O intreaga echipa de tehnicieni cu o formare profesionala deosebita, sta permanent la dispozitia clientilor.

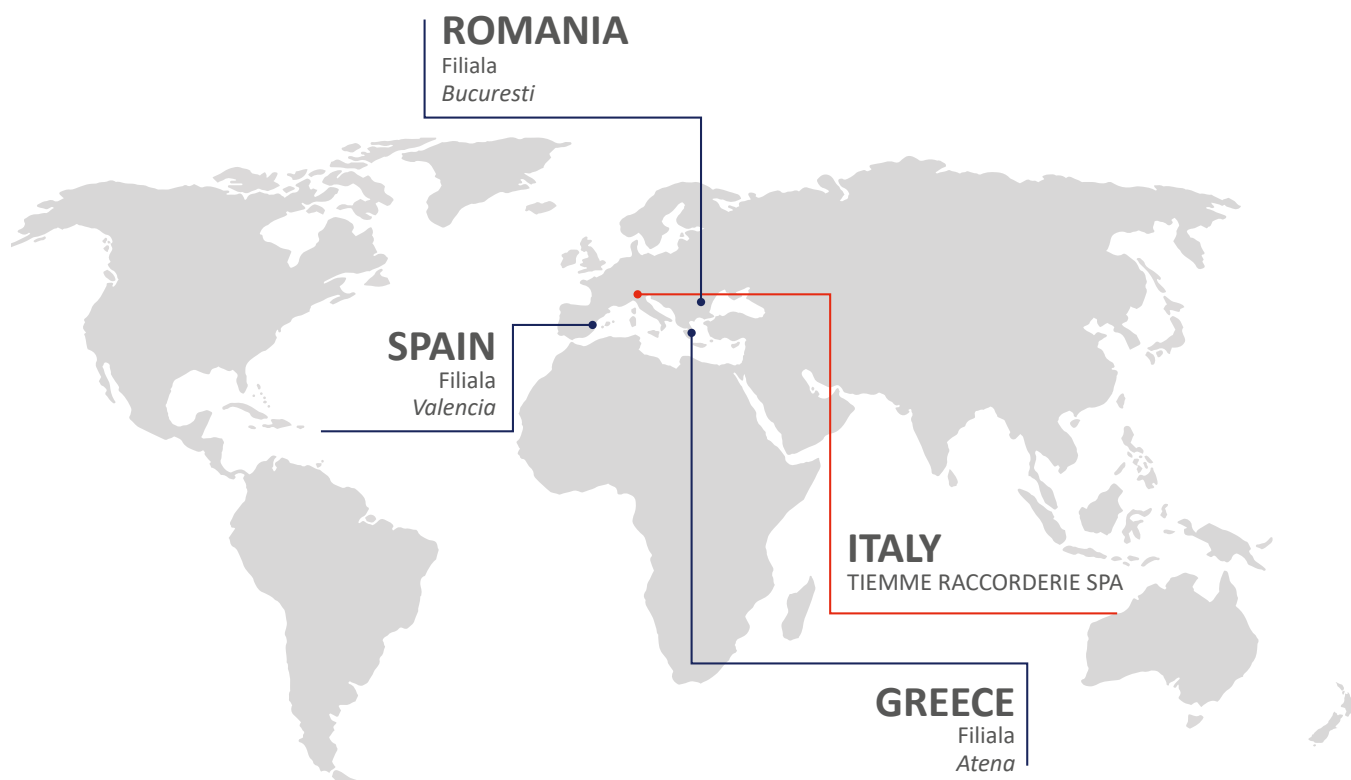



TIEMME
ORIGINAL ITALIAN TRADEMARK

CERTIFICARI

		ITALY RINA REGISTRO NAVALE ITALIANO		ARQB KVBG	BELGIUM UNIVERSITE LIBRE DE BRUXELLES
		ITALY ISTITUTO GIORDANO			UKRAINE ORGANO DI CERTIFICAZIONE COV "TECO"
		ITALY ICIM			SLOVAKIA TECHNICKÝ ŠKOLNÝ ÚSTAV PÚSTANY, Š.P.
		ITALY ICIM CERTIFICATO SECONDO DM N. 174/2004			CZECH REPUBLIC VÝZKUMNÝ ÚSTAV PODMĚNICH STAVBY - CERTIFIKACE SPOLČNOST S R.O.
		ITALY ISTITUTO NAZIONALE ASSICURAZIONE INFORTUNI SUL LAVORO			CZECH REPUBLIC STŘEDNĚNÍ ÚSTAV
		GERMANY DEUTSCHER VEREIN DES GAS- UND WASSERFACHES			RUSSIA GOST CERTIFICATION
		AUSTRIA LA HYGIENE CERTIFICATE			RUSSIA HYGIENE CERTIFICATE
		DENMARK ETA - DANISH BOARD OF EUROPEAN TECHNICAL APPROVAL FOR CONSTRUCTION PRODUCTS			RUSSIA EAC CERTIFICATE
		DENMARK GOKKENDT TIL BRUKSWIND			POLAND PAŃSTWOWY ZAKŁAD HIGIENY NACJONALNY INSTYTUT OF HYGIENE
		DENMARK DTI ENERGY DANSK TEKNOLOGISK INSTITUT			POLAND (INSTYTUT TECHNIKI) BUDOWLANE
		NORWAY SINTEF CERTIFICATION			HUNGARY ÉRTÉSELT MŰKÖZELÉS ÉRŐZŐ INNOVÁCIÓS NONPROFIT KFT.
		SWEDEN RISE RESEARCH INSTITUTES OF SWEDEN			UNITED KINGDOM BRITISH GAS TECHNOLOGY
		FINLAND YMPÄRISTÖMINISTERIÖN TYÖPIIRIYKÄSNTARAKOS THE FINNISH MINISTRY OF ENVIRONMENT			UNITED KINGDOM WATER REGULATION ADVISORY SCHEME
		SPAIN AENOR			UNITED KINGDOM KUKROG4
		HOLLAND CENTRUM VOOR GAS-TECHNOLOGIE			FRANCE LABORATOIRE SANTÉ ENVIRONNEMENT HYGIÈNE DE LYON
		HOLLAND CERTIFICATIE EN KEURINGEN			FRANCE CENTRE SCIENTIFIQUE ET TECHNIQUE DU BÂTIMENT
		PORTUGAL CERTIF ASSOCIAÇÃO PARA A CERTIFICAÇÃO			FRANCE CERTIFICATION NF
		ROMANIA AGREMENT TECHNIC IN CONSTRUCTII ROMÂNIA			BELARUS STRONTECHNORM
		BULGARIA TOV BULBULAND BULGARIA LTD.			SERBIA UNIVERSITY OF NIŠ FACULTY OF MECHANICAL ENGINEERING
		AUSTRALIA IAPMO WATERMARK LICENCE			EUROPE MARCHÉ CE DI PRODOTTO
		AUSTRALIA IAPMO OCEANIA MARK			VIETNAM TESTING CENTER 3
		AUSTRALIA AGA CERTIFIED PRODUCT			SOUTH AFRICA AENOR



2281

Robinet drept M ISO 228 cu piulita si maneta tip fluture

PAG. 26



2285

Robinet drept F ISO 228 cu piulita si maneta tip fluture

PAG. 26



2320AF - 2370AF
2258AF - 2263AF
2266OTW
2284SPCK
2266AF - 2266LAF
2267OT -
2267AF - 2273AF
2272LAF - 3346
2245 - 2247CK
2264AF - 2265AF
2279AF - 2283AF
2266AFCH
2263SET
2266AFCO
H9602 - H9604
2266QU
2271Q32 - 2266LP
 Robineti "waterworks"

PAG. 28



3925C

Robinet sublavoar si rozeta decorativa. Ventil ceramic

PAG. 43



1680XL

Cot M cu flansa cu 3 gauri de prindere, cu gat lung.

PAG. 80



1719CGXL

Consola cu racorduri 105° finale pentru peretii din ghips sp. 20 mm

PAG. 110

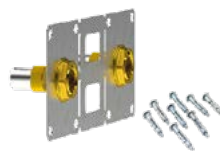

1702CG

Consola cu racorduri drepte finale pentru peretii din ghips

PAG. 110



1859A16

Adaptor pentru a transforma un filet 1/2"x16 in filet cu fata plana

PAG. 136



1521

Semiolandez

PAG. 179



1866CP

Colectoare MAXIMA din alama CW617N galbena cu iesiri 1/2" garnitura plata. [Interaxa 36 mm.](#) Filet fazat cu O-ring

PAG. 191



1812VIT

Pereche de suruburi pentru caseta universala art. 1812

PAG. 214



9564W - 9564ST
9564RS

Cap termostatic electronic comunicare Wi-Fi. Sistemul "Tiemme GATE"

PAG. 240



4524GRF - 4500

Panoul izolan din polistiren expandat sinterizat respecta normele UNI EN 13163. Grosimi disponibile conforme prevederilor normelor UNI EN 1264:2021

PAG. 265



4528PANGRF

Placa cu nuturi termoformata din polistiren expandat sinterizat cu grafit si acoperita cu o pelicula de plastic de culoare neagra. Grosimi disponibile conforme prevederilor normelor UNI EN 1264:2021

PAG. 267

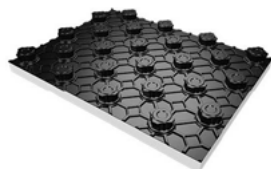

4501PAN

Placa cu nuturi termoformata din polistiren expandat sinterizat si acoperita cu o pelicula de plastic de culoare neagra.

PAG. 269



0210R

Tub din polietilena rezistenta la temperaturi ridicate COBRAPERT cu bariera oxigen (EVOH) Culoare rosie.

PAG. 270



3049KIT02D

Kit terminal cu by-pass diferential pentru colectoare "FLOOR"

PAG. 278



3898N

Grup de amestec pentru instalatii radiante. Versiunea nichelata

PAG. 291



3177 - 3177X

Grup de siguranta pentru boiler si acumulator acm

PAG. 316



1926

Supapa anti-inghet pentru pompa de caldura

PAG. 341

INDICE

ART	PAG	ART	PAG	ART	PAG	ART	PAG	ART	PAG	ART	PAG
0191X	66	1001	118	1116	380	1420P	100	1496	145	1552	169
0200B	153	1001	377	1117FD	382	1420P	107	1496	155	1552C	169
0200B	270	1002	118	1118	382	1420P	134	1496R42	155	1552FD	330
0200R	153	1003	119	1119FD	382	1420Z	100	1497	146	1552FD	377
0200R	270	1003	378	1120	126	1420Z	107	1497EST	146	1552FD	169
0210R	270	1004	118	1133	123	1420Z	134	1498MT	146	1552FDR	377
0230B	153	1005	119	1133	378	1428MP	98	1498SET	146	1552FDR	169
0230R	153	1005	378	1135	125	1428XL	98	1498UM	146	1552SET	376
0300B	150	1007	120	1135	380	1431	126	1498US	146	1552XL	169
0300BB	150	1007	379	1138	124	1433K	225	1500	182	1553FD	378
0300BL	151	1009	119	1138	379	1435	220	1501	182	1553FD	181
0300N	151	1010	120	1139	124	1435K	220	1502	183	1555	177
0300R	151	1014	128	1139	379	1435N	136	1503	183	1555CP	178
0330B	150	1014	380	1140	122	1435N	220	1504	183	1555R	178
0330R	150	1015	128	1141	123	1436	222	1505C04	100	1555SET	180
331G	231	1015	380	1142	125	1436	288	1505C04	107	1555SET	302
331H	231	1035	120	1143	125	1436K	223	1505C04	135	1555U	178
331HKIT	242	1035	380	1144	125	1436N	137	1507	181	1557	179
331HKIT01	242	1037	120	1145	125	1436N	222	1508	181	1557CP	179
332G	231	1039	119	1147	127	1436N	288	1510	182	1557SET	335
332H	231	1039	379	1147	380	1436N06	202	1511	182	1557SET	180
332HKIT	242	1039J	381	1147CZ	127	1436N06	289	1513	179	1557SET	302
332HKIT01	242	1039S	381	1147CZ	380	1450	96	1513	209	1560	174
475KIT	369	1040S	381	1220	172	1460	164	1514	179	1560C	175
475KITISOL	369	1040T	381	1233	219	1461	164	1514	209	1560CT	168
0600B	142	1100	121	1233N	219	1462	164	1516	182	1561	175
0625	144	1100FD	121	1235	219	1463	164	1517	182	1561C	175
0630B	142	1100FD	377	1235N	219	1464	164	1518	183	1561CT	168
0630R	142	1101	122	1240C	238	1465	164	1519	183	1561DIN	176
0635	143	1101	377	1240K	219	1467	165	1520	183	1562	174
0636	143	1102	121	1240N	136	1468	164	1521	179	1563	176
0640B	143	1102FD	121	1240N	219	1469	164	1521CP	179	1564FD	180
0640R	143	1102FD	377	1241K	222	1475	165	1521CPKIT	342	1564FD	379
0641	143	1103	123	1241N	138	1476	63	1521CPKIT	343	1565	178
0660	142	1103	378	1241N	222	1476	165	1522	180	1565CP	178
0660B	142	1104	122	1243K	225	1480P	155	1524	180	1565R	178
0660S	142	1104FD	122	1400	96	1480P	270	1524	337	1567	175
0700X	383	1104FD	378	1401	96	1481	63	1525N	180	1570	177
0705COL	383	1105	123	1402	96	1481	88	1525N	337	1570	295
0720X	383	1105	378	1403	97	1481	101	1530	172	1570	342
0721X	383	1106	123	1404	96	1481	113	1530C	173	1570C	177
0800B	152	1107	124	1405	97	1481	135	1531C	171	1570CT	168
0800R	152	1107	379	1406	97	1490	99	1540	170	1571	177
0805B	154	1108	124	1407	97	1490P43	99	1540C	170	1572	176
0805R	154	1109	124	1408	97	1491	99	1541	170	1572FD	176
0810B	152	1110	124	1409	97	1492MP	99	1550	171	1572FD	379
0810R	152	1113KB	381	1415	101	1493SET	92	1550C	171	1580	177
0900B	144	1114	128	1416	63	1493Z	88	1550CT	168	1581	173
0900B	154	1114	380	1416	101	1495	145	1551	171	1581C	174
0900R	144	1115	128	1420K	99	1495	155	1551C	172	1581FD	174
0900R	154	1115	380	1420K	134	1495	272	1551FD	172	1581FD	378
1000	118	1116	126	1420K (PEX)	100	1495R63	155	1551FD	377	1582	174

■ Noutati

INDICE

ART	PAG	ART	PAG	ART	PAG	ART	PAG	ART	PAG	ART	PAG
1583	180	1646GN	133	1665	335	1693PR	92	1807	214	1880C	181
1584C	176	1647GN	133	1666	74	1694	73	1810	212	1881	208
1585C	176	1649GN	134	1666	137	1695TM01	147	1812	212	1881	330
1590	185	1649YGN	133	1666	224	1695TM01B	147	1812VIT ■	214	1882	209
1591	185	1650	72	1666K	226	1695TM01C	147	1822	188	1883	200
1592	185	1650CT	70	1666K24	74	1695TM02	147	1822RCP	188	1884	200
1600	58	1651	72	1667	73	1695TM02B	147	1822RCP50	189	1885	200
1600OR	58	1651CT	70	1668	73	1695TM02C	147	1828Z	330	1885ISOL	200
1601	59	1651CY	75	1668	136	1695TM03	147	1829Z	256	1886	207
1601KB	59	1651FS	74	1668	221	1695TM03B	147	1832	188	1887	207
1602	58	1651KB	75	1669	76	1695TM03C	147	1832RCP	188	1889R	208
1602	330	1652	72	1670B	113	1696	24	1835C	46	1889TERMO	289
1603	61	1652	330	1670X	88	1696	90	1836P	47	1890	208
1604	59	1652CG	84	1671	73	1697	23	1837R	47	1890R	208
1605	60	1652CT	70	1672	86	1697	89	1859	87	1892	209
1606	60	1653	76	1672CY	86	1697CK	23	1859	137	1895	200
1607	62	1653CT	71	1673	86	1697CK	89	1859	224	1896	210
1608	61	1653KB	76	1674	75	1699	145	1859	226	1896	338
1609	62	1654	75	1675	81	1700	104	1859	289	1896GG	210
1610	63	1654CT	70	1675ISOL	81	1701	105	1859	330	1896GG	338
1611	63	1654U	82	1676	82	1701R	105	1859A16 ■	136	1898	210
1612C	60	1655	75	1676KB	82	1702	104	1859A16 ■	221	1898	339
1613C	61	1655CT	71	1676SM	82	1702CG ■	110	1863	214	1898G34	210
1614BP	58	1656	79	1676USM	82	1703	106	1863	286	1898G34	339
1615BP	60	1656CE	79	1677	87	1704	105	1863	301	1898KIT34	210
1616	60	1656DFCT	71	1678	81	1704U	108	1864P	301	1898KIT34	339
1616M	60	1656ISOL01	79	1679KB	81	1705	106	1865	214	1899	211
1619	61	1656ISOL02	80	1680XL ■	80	1706	106	1865	290	1899	339
1620	62	1656KB	80	1681	114	1707	108	1866CP ■	191	1900	211
1626	61	1656SM	79	1681	148	1707R	108	1866K	190	1900	339
1631G	126	1656XL	79	1681MINI	148	1709	108	1868K	190	1900G	211
1632K	193	1657	77	1681MINIRF	114	1710	106	1868KCOPPIA	190	1900G	339
1633K	225	1657CT	71	1681MINIRF	156	1715	104	1870	214	1900G34	211
1635	220	1658	77	1681RF	114	1716	105	1871K	193	1900G34	340
1635C	238	1659	77	1681RF	156	1716	136	1872	209	1900KITSUN	366
1635K	221	1659CT	71	1682	145	1716	137	1876K	194	1900KITSUN	382
1635N	136	1660	76	1683	145	1716	221	1876K50	194	1900N34	211
1635N	220	1660	92	1684	146	1716	224	1877K36	191	1900N34	339
1636	223	1660BP	76	1687	78	1716	225	1877K50	192	1900SUN	366
1636	288	1661	76	1688	86	1716K	225	1877K50	192	1901	211
1636K	223	1662	85	1689	146	1718	105	1877SKIT	214	1901	340
1636N	137	1662CG	85	1690	24	1719CG	110	1878	181	1901P	211
1636N	223	1662LG	85	1690	90	1719CGXL ■	110	1878	208	1901P	340
1636N	288	1663DI	80	1690U	24	1720X	113	1878	380	1901PN	211
1636N06	138	1664	80	1690U	90	1721U	108	1879	92	1901PN	340
1638GN	134	1664CG	83	1691	23	1722CY	107	1879	136	1910P	212
1640GN	132	1664CG55	83	1691	89	1730	107	1879	138	1912	199
1641GN	132	1664CG55XL	83	1692	24	1735	111	1879	221	1912R	199
1642GN	132	1664CGXL	83	1692	89	1736	111	1879	224	1913	210
1643GN	132	1664DI	80	1692CK	24	1740	112	1879K	226	1913	338
1644GN	133	1665	74	1692CK	89	1740U	112	1880	181	1913G	210
1645GN	133	1665	330	1693	92	1746	112	1880	208	1913G	339

■ Noutati

INDICE

ART	PAG	ART	PAG	ART	PAG	ART	PAG	ART	PAG	ART	PAG
1914	210	2079INV	320	2155FLR	22	2230	13	2320AF ■	28	2944	66
1914	338	2080	317	2155FLR	65	2230V	14	2320GR	4	2944K	66
1916	316	2080	355	2155R	22	2230X	13	2321	6	2945	37
1916SUN	367	2080POST	317	2155R	65	2231	13	2321GR	4	2946GR	37
1917	314	2080POST	355	2156R	22	2231V	14	2325T	7	2947	37
1917M	315	2081	317	2156R	65	2232	16	2326T	7	2948	40
1917MAN	315	2094	50	2157R	23	2233	16	2330SUN	366	2950	42
1917SUN	367	2095R	330	2157R	66	2240G	53	2331SUN	366	2953	42
1918	314	2114CPRKIT	20	2160	22	2241G	53	2340	33	2954	42
1918MAN	316	2114CPRKIT	206	2160	65	2245 ■	30	2360	2	2955	40
1919	320	2114CPRKIT	285	2161	22	2246 ■	30	2360R07	10	2956	40
1920	212	2116CPRKIT	20	2161	65	2247CK ■	30	2361	2	2959	40
1921OG	318	2116CPRKIT	206	2162SUN	366	2258AF ■	28	2361R07	10	2960	44
1921OM	318	2116CPRKIT	285	2163	64	2262G	56	2370	2	2960PR	44
1921OP	318	2120R	19	2180	17	2263	26	2370AF ■	28	2960PR	91
1922	199	2120R	204	2180CP	18	2263AF ■	28	2370G07	51	2960PR	113
1923	319	2120R	284	2180CPR	18	2263CK	26	2370R07	10	2960SET	44
1923FL	319	2121	17	2180CPR	204	2263G	56	2371	2	2960SET	91
1924	319	2121CP	17	2181CPR	23	2263SET ■	31	2371G07	51	2960SET	113
1926 ■	341	2121CP	330	2181CPR	66	2264AF ■	30	2371R07	10	2961	45
1927	314	2121CPT	17	2181CPR	204	2265AF ■	30	2371SUN	366	2961SET	44
1927M	315	2121R	17	2182	18	2266	26	2372	3	2961SET	91
1927MAN	315	2121R	203	2182	205	2266AF ■	29	2380G07	51	2961SET	113
1927SUN	367	2121R	284	2182R	18	2266AFCH ■	31	2380R07	11	2962	50
1928	314	2121RSAC	17	2182R	203	2266AFCO ■	31	2381G07	51	2963SET	44
1928MAN	316	2121RSAC	205	2182R	284	2266CK	26	2381R07	11	2963SET	91
1929	320	2121RSAC	284	2182RSAC	19	2266G	56	2450	8	2963SET	113
1930	212	2133	38	2182RSAC	205	2266LAF ■	29	2451	8	2964	45
1931	212	2133	215	2182RSAC	284	2266LP ■	33	2460	8	2964Z	45
1931	291	2134	38	2183R	19	2266OT	28	2461	8	2965	45
1935	358	2134	215	2183R	204	2266OTW ■	28	2471	8	2965PROL	45
1939	213	2134SUN	370	2183R	284	2266QU ■	33	2472	8	2966	43
1939	287	2136	38	2184CPRKIT	20	2266SP	27	2510	34	2967	45
1940	213	2136	215	2184CPRKIT	206	2267AF ■	29	2511B	34	2970	45
1940	287	2137	38	2184CPRKIT	285	2267OT ■	29	2512B	34	2971SET	44
1940	294	2137	215	2186CPRKIT	20	2270	33	2520	34	2971SET	91
1941	213	2138	38	2186CPRKIT	206	2271	33	2530X316	34	2971SET	113
1941	290	2138	215	2186CPRKIT	285	2271Q32 ■	33	2535V	34	2990G	46
2070	207	2139	38	2200G	52	2272LAF ■	29	2584	34	2990G	207
2070	281	2139	215	2201G	52	2273AF ■	29	2585G	35	2990G	286
2070	286	2142	25	2210R	12	2277	29	2588C	35	2991SUN	366
2074MAX	320	2143	21	2211R	12	2279AF ■	30	2595	50	3000X	371
2074MIN	320	2143	64	2220G	52	2281 ■	26	2596	50	3001KB	371
2075	311	2152	25	2220R	12	2283AF ■	30	2900	36	3001X	371
2075KIT01	301	2153	21	2221G	52	2284SPCK ■	28	2901	36	3002X	371
2075KIT02	301	2153	64	2221R	13	2285 ■	26	2902	36	3003KB	372
2075KIT03	334	2153FLR	21	2223G	56	2286KIT ■	291	2931	36	3004X	372
2076	311	2153FLR	64	2224G	56	2310	4	2932	36	3005X	372
2077	311	2154FLR	21	2224N	27	2310GR	4	2940	36	3007KB	372
2078	311	2154FLR	64	2225G	56	2311	5	2941	37	3011X	371
2079	320	2154R	21	2228	27	2311GR	4	2942	36	3015	372
2079-3V	320	2154R	64	2229	27	2320	5	2944	37	3023	197

■ Noutati

INDICE

ART	PAG	ART	PAG	ART	PAG	ART	PAG	ART	PAG	ART	PAG
3023RAC	197	3170	321	3308	235	3461W	158	3873RBYDJ	274	3896PFBYD	300
3033	197	3175CT	317	3308KIT04	243	3462CR	161	3873RJ	274	3896PFHT	300
3035	197	3175ISOL	317	3308KIT04R	243	3462W	158	3874	289	3896PFHTBYD	300
3046	201	3177 ■	316	3312	232	3463CR	162	3874P	202	3898I ■	291
3047	201	3177X ■	316	3313	232	3463W	158	3874P	289	3898IHT ■	291
3048	201	3177XSUN	367	3320	245	3464CR	161	3875XT	281	3898KHT ■	291
3049	277	3180	355	3321	245	3464W	158	3877	275	3898N ■	291
3049I	277	3180C	321	3325	245	3465CR	162	3877BYD	275	3899G3	293
3049KIT01	278	3200X	374	3326	245	3465W	158	3877R	276	3899G3BY	293
3049KIT01J	278	3201KB	374	3330	236	3466CR	162	3877RBYD	276	3900C	41
3049KIT02D ■	278	3201X	374	3330C	238	3467CR	163	3878	273	3901C	41
3049KIT02JD	278	3202X	374	3331	236	3467W	159	3878BYD	273	3902C	41
3049SKIT	214	3203KB	375	3331C	238	3468CR	162	3878R	274	3903C	41
3049SKIT	301	3204X	374	3335	236	3468W	159	3878RBYD	274	3905C	43
3050	277	3205X	374	3335C	238	3469CR	162	3879	275	3906C	41
3050I	277	3211X	374	3336	236	3469W	159	3879BYD	275	3907C	41
3053	202	3227DX	233	3336C	238	3470CR	162	3879R	276	3908C	42
3054	202	3227SX	233	3338	255	3471CR	161	3879RBYD	276	3909C	43
3055	202	3228DX	232	3339	209	3472	163	3880GPF	334	3910	43
3100N	354	3228SX	232	3340C	254	3472W	159	3880GSM	334	3911	43
3107N	354	3230EXCEL	249	3341	209	3473	163	3887	302	3912	43
3108N	354	3231EXCEL	248	3342	254	3473W	159	3888	302	3916C	42
3110N	354	3231EXPTFE	248	3345N	254	3474	159	3889	302	3925C ■	43
3120N	352	3233EXCEL	248	3350	255	3474	163	3890P	302	3992	46
3130N	351	3235EXCEL	248	3350	340	3475	160	3890P	335	3992OT	46
3131N	351	3236EXCEL	248	3351	255	3475	163	3890PG3	365	3992PAL	46
3135N	351	3236EXPTFE	248	3351	340	3500	47	3890PG4	365	3994	45
3136N	351	3260	247	3352	255	3501	359	3890PU	335	3996L	46
3140	352	3261	246	3352	286	3506	47	3890PV	335	3996T	46
3141	337	3261KIT01	249	3352	340	3506SUN	366	3890PW2	302	3997	42
3142	336	3261KITR01	249	3353G	382	3510	48	3890PW2	335	4490	244
3142T	337	3261PTFE	247	3365N	252	3600	48	3890PW4	365	4490C	244
3144	322	3263	246	3370K	252	3606	48	3890PW5	335	4491	244
3144ISOL	322	3265	246	3371K	252	3650	49	3890SKIT	301	4491C	244
3144MAG	323	3266	246	3375K	252	3651	49	3890TTVD	295	4492	244
3145	352	3266KIT01	249	3376K	252	3660	48	3890TTVD	342	4492C	244
3146KIT	336	3266KITR01	249	3381KDX	250	3665	48	3890VD	295	4500 ■	265
3146OR	337	3266PTFE	246	3381KSX	250	3670	49	3890VD	342	4501PAN ■	269
3146X	337	3300	234	3383K	250	3670	353	3890VDKIT	295	4503	271
3148	336	3300ATTR	255	3383SOND	252	3681	48	3891G0001	302	4507	270
3148A	337	3300C	237	3384K	251	3855X	282	3891N	280	4508	271
3149	337	3301	234	3386K	251	3856N	279	3891N	283	4522	272
3150	336	3301C	237	3387K	251	3856X	282	3891NBY	280	4522A	272
3154	336	3302	235	3388K	251	3865X	282	3891NBY	283	4524GRF ■	265
3154C	336	3303	235	3390RID	253	3866N	279	3891NBYJ	280	4527	270
3155	338	3303KIT04	243	3391	253	3866X	282	3891NBYJ	283	4528PANGRF ■	267
3155POL	338	3303KIT04R	243	3391BY	253	3868G	297	3891NJ	280	4530	145
3160GN	321	3305	234	3393	253	3868GHTPP2	297	3891NJ	283	4530	155
3161	321	3305C	237	3393BY	253	3868GHTPP3	298	3894VDSUN	370	4530	272
3165	322	3306	234	3460CR	161	3871XT	281	3895KCL	292	4532	271
3165ISOL	322	3306C	237	3460W	158	3873BYD	273	3895KPF	292	4535	272
3167ISOL	323	3307	235	3461CR	161	3873J	273	3896PF	300	4539	271

■ Noutati

INDICE

ART	PAG	ART	PAG	ART	PAG	ART	PAG
4540	270	5538G3M4	325	9551	239	H9706CV	255
4601	241	5538G3M6	325	9552NX	254	H9708	207
4601	307	5538G4M6	325	9552P06	254	H9708	286
4606	307	5538G4M8	325	9553	239	H9709	207
4607	307	5538X	323	9553AM1	239	H9709	286
4612	307	5539X	323	9553AM2	239	PCONT01	54
4625D	305	5540G2M4	326	9553C	239	PCONT01SER	54
4712LPS	365	5540G3M4	326	9553CHT	239	PCONT02	54
4722KITFX	365	5540G3M6	326	9553INS	239	PCONT02SER	54
4730V	370	5540G4M6	326	9556	239	PCONT03	54
4731ANTIG	370	5540G4M8	327	9556USB	239	PCONT03SER	54
4732	343	5540G5M6	327	9556W	241	PCONT04	54
4735E	364	5540G5M10	327	9556W	307	PCONT04SER	54
4736SONDA	364	5540G6M8	327	9558	239	PCONT05	55
4737	356	5540G6M12	328	9561KIT01	301	PCONT05SER	55
4737SUN	368	5540G7M8	328	9561KIT02	334	PCONT06	55
4738	356	5540G7M14	328	9561T	382	PCONT07	55
4738KIT	368	5540X	323	9562SERV	334	PCONT07SER	55
4738KIT01	356	5540X	323	9564RS ■	240	PCONT08	55
4738KR	357	6535DN	343	9564RS ■	309	R616	184
4738SUN	368	6535DNISOL	349	9564ST ■	240	R616NAS	184
4739	356	6535DNMANOP349		9564ST ■	309		
4739SUN	368	6535ET	350	9564W ■	240		
4744	363	6535G	343	9564W ■	309		
4745	362	6535ISOL	349	9567	207		
4745C	364	6535PP	349	9567	286		
4745E	362	6536	350	9567	301		
4745MANOP	334	6538	347	9567	304		
4745MANOP	365	6539	347	9567KIT	203		
4745R	363	6540	348	9567KIT	290		
4745TRMF	363	6541CC	344	9568	256		
4746	179	6542ATT	350	9568	304		
4746	370	6542CC	345	9575	304		
4746KIT	370	6542CCS	346	9580	304		
4747	364	6542PP	349	9580W	241		
4748D	364	6542SERV	350	9580W	307		
4749E	365	6542SERV2	350	9581	304		
4749FLOW	364	6543CH	349	9582U	306		
4749FLOWE	364	6545CH	349	9583CU	306		
5532HYBRID	341	7166	324	9587	304		
5532PDC	341	7167	324	9589	310		
5534G	333	7169	319	9590	310		
5534G3P	333	8930IM	376	9591	310		
5535DIFF	334	8930SET	376	9592	310		
5535G	331	9341SET	376	H8996	207		
5535G3P	332	9535	38	H9300	63		
5535GPF	331	9535	215	H9300	88		
5536G	332	9536	39	H9302	195		
5536GS	333	9536	216	H9602 ■	31		
5537KIT	334	9537	38	H9604 ■	31		
5538G2M3	324	9537	215	H9705	255		
5538G2M4	324	9550	254	H9706CAP	255		





■ Noutati



01A Vane si robineti pentru apa

Robineti cu sfera "MISTRAL"		2
Robineti cu sfera "SCIROCCO" cu trecere totala		4
Robineti cu sfera "BURAN" cu trecere totala și presetupa reglabila		8
Robineti cu sfera "TORNADO" ISO 7/EN 10226		10
Robineti cu sfera "URAGANO" cu trecere totala		12
Robineti cu sfera pentru colectoare		17
Robineti cu capete de compresiune/presare		21
Robineti cu sfera pentru apa		26
Robineti "WATERWORKS"		28
Robineti cu sfera dublu serviciu "EOLO"		34
Robineti cu sertar		35
Minirobineti cu sfera cromata "SMALL"		36
Minirobineti cu sfera "SMALL"		37
Robineti cu sfera, motorizati		38
Robineti cu sfera pentru aplicatii speciale		40
Supape de sens		47
Filtre Y		49

01B Vane si robineti pentru gaz

Robineti cu sfera "TORNADO" pentru gaz		51
Robineti cu sfera "URAGANO" pentru gaz - EN 331		52
Robineti de instalat dupa montarea contorului de gaz		54
Robineti cu sfera pentru gaz		56



2360



Robinet F/F ISO 228 cu maneta de aluminiu de culoare rosie și neagră

Cod	Dimensiune	Pret €	Ambalare
 maneta tip levier rosie			
236 0010	1/2"		25/100
236 0007	3/4"		15/60
236 0005	1"		12/48
236 0008	1"1/4		8/32
236 0009	1"1/2		4/16
236 0004	2"		2/8
 maneta tip levier neagră			
236 0175	1/2"		25/100
236 0176	3/4"		15/60
236 0177	1"		12/48
236 0184	1"1/4		8/32
236 0185	1"1/2		4/16
236 0186	2"		2/8



2361



Robinet M/F ISO 228 cu maneta de aluminiu de culoare rosie și neagră

Cod	Dimensiune	Pret €	Ambalare
 maneta tip levier rosie			
236 0015	1/2"		25/100
236 0019	3/4"		15/60
236 0014	1"		12/48
236 0023	1"1/4		8/32
236 0029	1"1/2		4/16
236 0026	2"		2/8
 maneta tip levier neagră			
236 0178	1/2"		25/100
236 0179	3/4"		15/60
236 0180	1"		12/48
236 0187	1"1/4		8/32
236 0188	1"1/2		4/16
236 0189	2"		2/8



2370



Robinet F/F ISO 228 cu maneta tip fluture de culoare rosie și neagră

Cod	Dimensiune	Pret €	Ambalare
 maneta tip fluture rosie			
236 0002	1/2"		25/100
236 0003	3/4"		15/60
236 0012	1"		12/48
236 0035	1"1/4		8/32
 maneta tip fluture neagră			
236 0190	1/2"		25/100
236 0191	3/4"		15/60
236 0192	1"		12/48
236 0193	1"1/4		8/32



2371

Robinet M/F ISO 228 cu maneta tip fluture de culoare rosie și neagră

Cod	Dimensiune	Pret €	Ambalare
 maneta tip fluture rosie			
236 0001	1/2"		25/100
236 0006	3/4"		15/60
236 0011	1"		12/48
236 0031	1"1/4		8/32
 maneta tip fluture neagră			
236 0182	1/2"		25/100
236 0183	3/4"		15/60
236 0181	1"		12/48
236 0194	1"1/4		8/32



2372

Robinet M/M ISO 228 cu maneta tip fluture de culoare rosie

Cod	Dimensiune	Pret €	Ambalare
 maneta tip fluture rosie			
236 0032	1/2"		25/100
236 0038	3/4"		15/60
236 0040	1"		12/48
236 0048	1"1/4		8/32

DIMENSIUNI

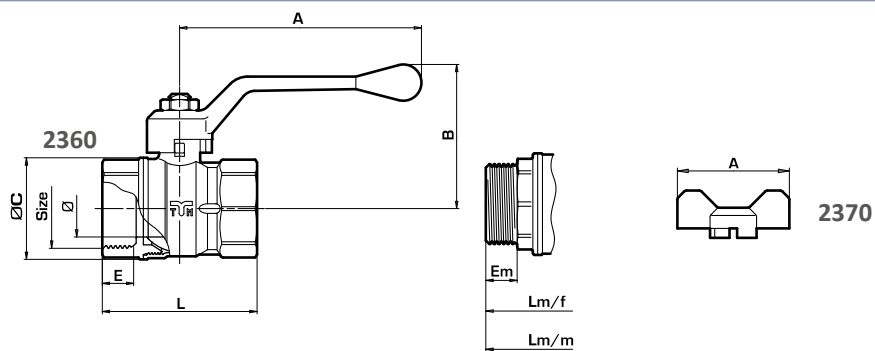

Dimensiune	1/2"	3/4"	1"	1"1/4	1"1/2	2"
Ø (DN)	14	18	23,5	30	37,5	47
A	85	85	100	100	140	140
A 2370	50	50	65	65	-	-
B	48	52,5	59,5	64,5	76	89
ØC	27,5	33,5	42	53	64	79
E	11	11	14	15	16	17,5
L	45	52,5	64	74	85	98
Em	10	10	13	14	15	16,5
Lm/f	51,5	57,5	68,5	81	92	107
Lm/m	50	55,5	66,5	79	-	-
PN	40	30	30	25	25	25

Toate dimensiunile cu exceptia PN-ului sunt exprimate in mm



2310GR

Robinet F/F ISO 228 cu maneta de aluminiu de culoare rosie

Cod	Dimensiune	Pret €	Ambalare
231 0066	1/2"		20/80
231 0067	3/4"		15/60
231 0068	1"		10/40
231 0069	1"1/4		4/16

Până la terminarea stocului



2311GR

Robinet M/F ISO 228 cu maneta de aluminiu de culoare rosie

Cod	Dimensiune	Pret €	Ambalare
231 0079	1/2"		25/100
231 0080	3/4"		10/40
231 0081	1"		10/40
231 0082	1"1/4		4/16

Până la terminarea stocului



2320GR

Robinet F/F ISO 228 cu maneta tip fluture de culoare rosie

Cod	Dimensiune	Pret €	Ambalare
231 0094	1/2"		25/100
231 0095	3/4"		20/80
231 0096	1"		10/40

Până la terminarea stocului



2321GR

Robinet M/F ISO 228 cu maneta tip fluture de culoare rosie

Cod	Dimensiune	Pret €	Ambalare
231 0105	1/2"		25/100
231 0106	3/4"		20/80
231 0108	1"		10/40

Până la terminarea stocului



2310

Robinet F/F ISO 228 cu maneta de aluminiu de culoare rosie neagră și albastră

Cod	Dimensiune	Pret €	Ambalare
-----	------------	--------	----------



maneta tip levier rosie

231 0045	1/4" ISO7		25/100
231 0034	3/8" ISO7		25/100
231 0002	1/2"		20/80
231 0008	3/4"		15/60
231 0001	1"		10/40
231 0005	1"1/4		4/16
231 0009	1"1/2		3/12
231 0004	2"		2/8
231 0037	2" 1/2		1/4
231 0021	3"		1/3
231 0027	4"		1/1



maneta tip levier neagră

231 0145	1/4" ISO7		25/100
231 0059	3/8" ISO7		25/100
231 0146	1/2"		20/80
231 0147	3/4"		15/60
231 0148	1"		10/40
231 0149	1"1/4		4/16
231 0150	1"1/2		3/12
231 0151	2"		2/8
231 0152	2" 1/2		1/4
231 0153	3"		1/3
231 0154	4"		1/1



maneta tip levier albastră

231 0365	1/2"		20/80
231 0366	3/4"		15/60
231 0367	1"		10/40
231 0368	1"1/4		4/16
231 0369	1"1/2		3/12
231 0370	2"		2/8

Noutati





01A ROBINETI CU SFERA "SCIROCCO" CU TRECERE TOTALA



2311

Robinet M/F ISO 228 cu maneta de aluminiu de culoare rosie neagră și albastra



Cod	Dimensiune	Pret €	Ambalare
 maneta tip levier rosie			
231 0054	1/4" ISO7		25/100
231 0041	3/8" ISO7		25/100
231 0013	1/2"		25/100
231 0014	3/4"		10/40
231 0011	1"		10/40
231 0018	1"1/4		4/16
231 0025	1"1/2		3/12
231 0023	2"		2/8
 maneta tip levier neagră			
231 0071	1/4" ISO7		25/100
231 0072	3/8" ISO7		25/100
231 0155	1/2"		25/100
231 0156	3/4"		10/40
231 0157	1"		10/40
231 0158	1"1/4		4/16
231 0159	1"1/2		3/12
231 0160	2"		2/8
 maneta tip levier albastra			
231 0371	1/2"		25/100
231 0372	3/4"		10/40
231 0373	1"		10/40
231 0374	1"1/4		4/16
231 0375	1"1/2		3/12
231 0376	2"		2/8

Noutati



2320

Robinet F/F ISO 228 cu maneta tip fluture de culoare rosie neagră și albastra



Cod	Dimensiune	Pret €	Ambalare
 maneta tip fluture rosie			
231 0053	1/4" ISO7		25/100
231 0020	3/8" ISO7		25/100
231 0010	1/2"		25/100
231 0012	3/4"		20/80
231 0016	1"		10/40
 maneta tip fluture neagră			
231 0087	1/4" ISO7		25/100
231 0088	3/8" ISO7		25/100
231 0161	1/2"		25/100
231 0162	3/4"		20/80
231 0163	1"		10/40
 maneta tip fluture albastra			
231 0210	3/8" ISO7		25/100
231 0084	1/2"		25/100
231 0085	3/4"		20/80
231 0086	1"		10/40

Noutati



2321

Robinet M/F ISO 228 cu maneta tip fluture de culoare rosie neagră și albastra

Cod	Dimensiune	Pret €	Ambalare
 maneta tip fluture rosie			
231 0052	1/4" ISO7		25/100
231 0022	3/8" ISO7		25/100
231 0003	1/2"		25/100
231 0006	3/4"		20/80
231 0007	1"		10/40
 maneta tip fluture neagră			
231 0164	1/4" ISO7		25/100
231 0100	3/8" ISO7		25/100
231 0165	1/2"		25/100
231 0166	3/4"		20/80
231 0167	1"		10/40
 maneta tip fluture albastra			
231 0097	1/2"		25/100
231 0098	3/4"		20/80
231 0099	1"		10/40

 Noutati



01A ROBINETI CU SFERA "SCIROCCO" CU TRECERE TOTALA



2325T

Robinet SCIROCCO feminin/
feminin ISO228 cu maner din
plastic in forma "T"



2326T

Robinet SCIROCCO masculin/
feminin ISO228 cu maner din
plastic in forma "T"

Cod	Dimensiune	Pret €	Ambalare
231 0344	1/2"		10/40
231 0345	3/4"		8/32
231 0346	1"		6/24

Cod	Dimensiune	Pret €	Ambalare
231 0347	1/2"		10/40
231 0348	3/4"		8/32
231 0349	1"		6/24

DIMENSIUNI

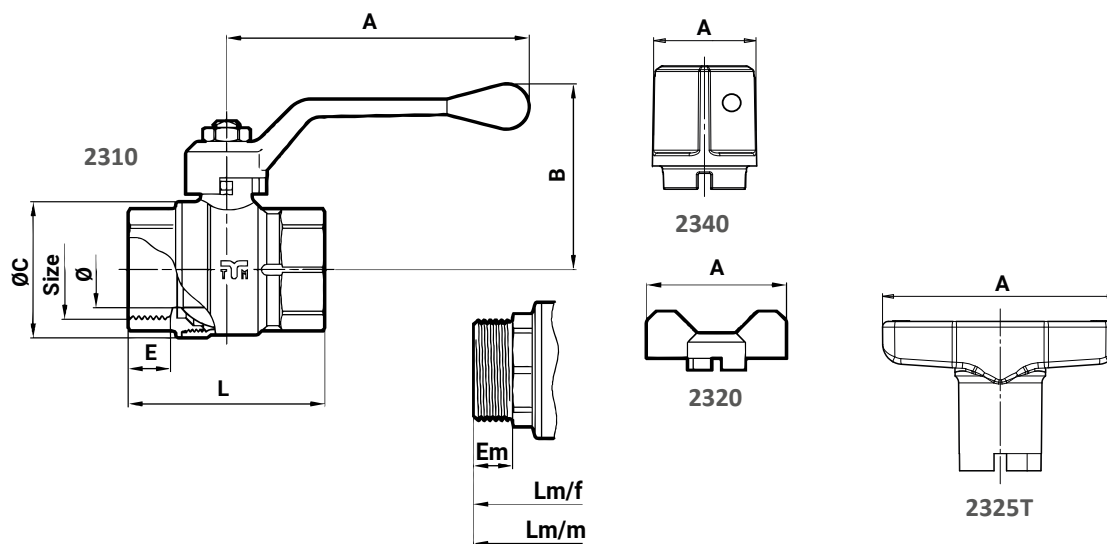

Dimensiune	1/4"	3/8"	1/2"	3/4"	1"	1"1/4	1"1/2	2"	2"1/2	3"	4"
Ø (DN)	10	10	15	20	25	32	40	50	60	74	94
A	85	85	85	85	100	140	140	140	240	240	240
A 2320	50	50	50	50	65	-	-	-	-	-	-
A 2340	-	-	36	-	-	-	-	-	-	-	-
A 2325T	-	-	82	82	82	-	-	-	-	-	-
B	46	46	51,5	54,5	61,5	73	79	91,5	118	128	142
B 2325T	-	-	70	72,5	78,5	-	-	-	-	-	-
ØC	23	23	30	37	45	55	68	84	103	124	152
E	10	12	13,5	14,5	14	15	16	17,5	21,5	23,5	27
L	42	47	53	60,5	65	77,5	89	103	130	149	178
Em	11	11,5	10	12	13	14	15	16,5	-	-	-
Lm/f	43	57	56,5	64	70	85,5	96,5	114	-	-	-
Lm/m	-	56	53,5	59,5	69	84	96,5	114	-	-	-
PN	50	50	50	40	40	30	30	25	18	16	16

Toate dimensiunile cu exceptia PN-ului sunt exprimate in mm



2450

Robinet BURAN F/F ISO 228 cu presetupă reglabilă și manetă de aluminiu de culoare neagră

Cod	Dimensiune	Pret €	Ambalare
245 0007	1/2"		20/80
245 0008	3/4"		15/60
245 0009	1"		8/32
245 0023	1"1/4		4/16
245 0024	1"1/2		3/12
245 0025	2"		2/8
231 0152	2" 1/2		1/4
231 0153	3"		1/3
231 0154	4"		1/1



2451

Robinet BURAN M/F ISO 228 cu presetupă reglabilă și manetă de aluminiu de culoare neagră

Cod	Dimensiune	Pret €	Ambalare
245 0013	1/2"		20/80
245 0014	3/4"		15/60
245 0015	1"		8/32
245 0027	1"1/4		4/16
245 0028	1"1/2		3/12
245 0029	2"		2/8



2460

Robinet BURAN F/F ISO 228 cu presetupă reglabilă și manetă tip fluture de culoare neagră

Cod	Dimensiune	Pret €	Ambalare
245 0010	1/2"		25/100
245 0011	3/4"		15/60
245 0012	1"		10/40
245 0026	1"1/4		5/20



2461

Robinet BURAN M/F ISO 228 cu presetupă reglabilă și manetă tip fluture de culoare neagră

Cod	Dimensiune	Pret €	Ambalare
245 0016	1/2"		25/100
245 0017	3/4"		15/60
245 0018	1"		10/40
245 0030	1"1/4		5/20



2471

Robinet BURAN M/F ISO 228 cu presetupă reglabilă, manetă de aluminiu de culoare neagră și racord olandez

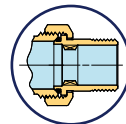

Cod	Dimensiune	Pret €	Ambalare
245 0001	1/2"		15/60
245 0002	3/4"		10/40
245 0003	1"		6/24
245 0019	1"1/4		4/16
245 0020	1" 1/2		1/4
245 0021	2"		1/2



2472

Robinet BURAN M/F ISO 228 cu presetupă reglabilă, manetă tip fluture de culoare neagră și racord olandez

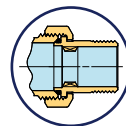

Cod	Dimensiune	Pret €	Ambalare
245 0004	1/2"		15/60
245 0005	3/4"		10/40
245 0006	1"		7/28
245 0022	1"1/4		5/20

DIMENSIUNI

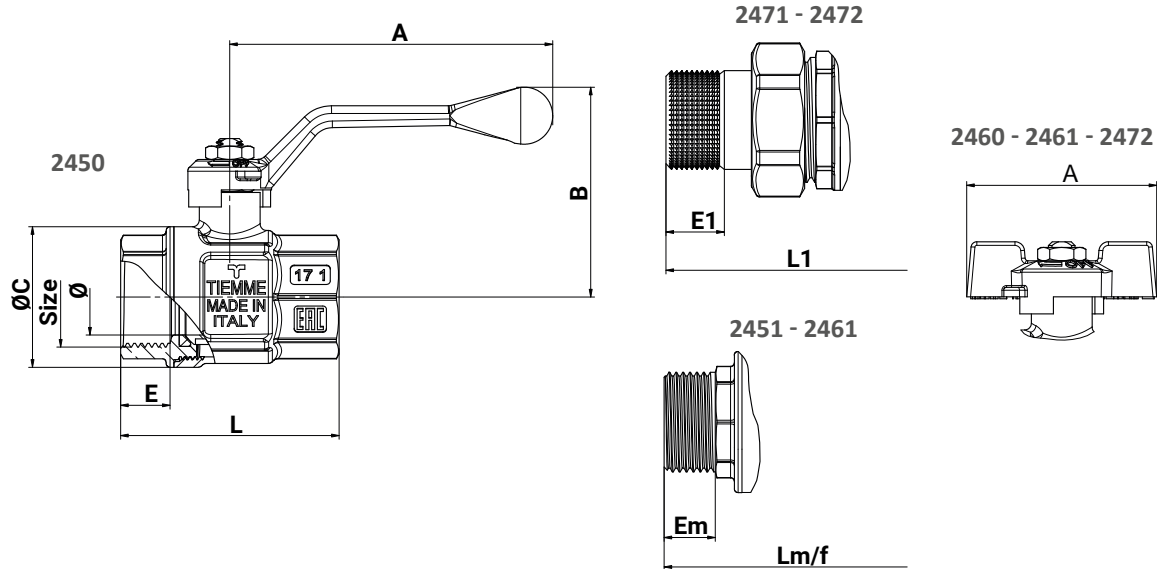

Dimensiune	1/2"	3/4"	1"	1"1/4	1"1/2	2"	2"1/2	3"	4"
Ø (DN)	15	20	25	32	40	50	60	74	94
A	85	85	100	100	160	160	240	240	240
A2460	50	50	65	65	-	-	-	-	-
B	52	55,2	62,5	68	88,5	99	118	128	142
Ø C	30	37	45	57	68	84	103	124	152
E	12	13	15	16,5	16	17,5	21,5	23,5	27
E1	12,5	14	16	15	18	18	21,5	23,5	27
L	50	57,5	68	81,5	89	103,5	130	149	178
L1	79,5	89,5	104	122	133,5	154,5	130	149	178
Em	11,5	13,5	14,5	17	15	16,5	-	-	-
Lm/f	56,5	64	76	90	96,5	114,5	-	-	-
PN	64	50	50	50	40	40	18	16	16

Toate dimensiunile cu exceptia PN-ului sunt exprimate in mm

DETALIU PRESETUPA

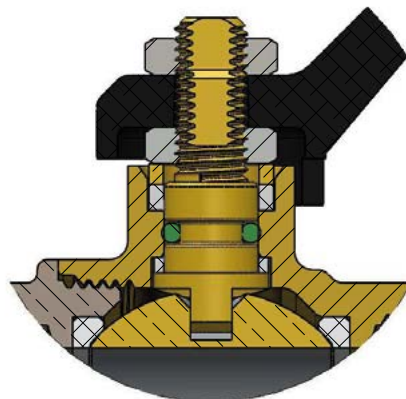



2360R07

Robinet F/F ISO 7/EN 10226 cu maneta de aluminiu de culoare rosie și neagră

Cod	Dimensiune	Pret €	Ambalare
 maneta tip levier rosie			
238 0010	1/2"		20/80
238 0008	3/4"		10/40
238 0002	1"		8/32
238 0013	1"1/4		4/16
238 0014	1"1/2		3/12
238 0003	2"		2/8
 maneta tip levier neagră			
238 0043	1/2"		20/80
238 0034	3/4"		10/40
238 0051	1"		8/32
238 0044	1"1/4		4/16
238 0035	1"1/2		3/12
238 0036	2"		2/8



2361R07



Robinet M/F ISO 7/EN 10226 cu maneta de aluminiu de culoare rosie și neagră

Cod	Dimensiune	Pret €	Ambalare
 maneta tip levier rosie			
238 0016	1/2"		20/80
238 0012	3/4"		10/40
238 0011	1"		8/32
238 0019	1"1/4		4/16
238 0022	1"1/2		3/12
238 0021	2"		2/8
 maneta tip levier neagră			
238 0037	1/2"		20/80
238 0047	3/4"		10/40
238 0038	1"		8/32
238 0048	1"1/4		4/16
238 0049	1"1/2		3/12
238 0050	2"		2/8



2370R07



Robinet F/F ISO 7/EN 10226 cu maneta tip fluture de culoare rosie și neagră

Cod	Dimensiune	Pret €	Ambalare
 maneta tip fluture rosie			
238 0015	1/2"		25/100
238 0017	3/4"		15/60
238 0024	1"		8/32
238 0028	1"1/4		5/20
 maneta tip fluture neagră			
238 0039	1/2"		25/100
238 0045	3/4"		15/60
238 0040	1"		8/32
238 0052	1"1/4		5/20



2371R07

Robinet M/F ISO 7/EN 10226 cu maneta tip fluture de culoare rosie și neagră

Cod	Dimensiune	Pret €	Ambalare
 maneta tip fluture rosie			
238 0001	1/2"		25/100
238 0004	3/4"		15/60
238 0009	1"		8/32
238 0025	1"1/4		5/20
 maneta tip fluture neagră			
238 0041	1/2"		25/100
238 0042	3/4"		15/60
238 0046	1"		8/32
238 0053	1"1/4		5/20

01A ROBINETI CU SFERA "TORNADO" ISO 7/EN 10226



2380R07

Robinet F/F ISO 7/EN 10226 cu maneta de otel de culoare rosie



2381R07

Robinet M/F ISO 7/EN 10226 cu maneta de otel de culoare rosie

Cod	Dimensiune	Pret €	Ambalare
238 0006	1/2"		20/80
238 0007	3/4"		14/56
238 0005	1"		10/40
238 0018	1"1/4		6/24
238 0023	1"1/2		3/12
238 0020	2"		2/8

Cod	Dimensiune	Pret €	Ambalare
238 0026	1/2"		20/80
238 0029	3/4"		10/40
238 0027	1"		8/32
238 0030	1"1/4		4/16
238 0031	1"1/2		3/12
238 0032	2"		2/8

DIMENSIUNI

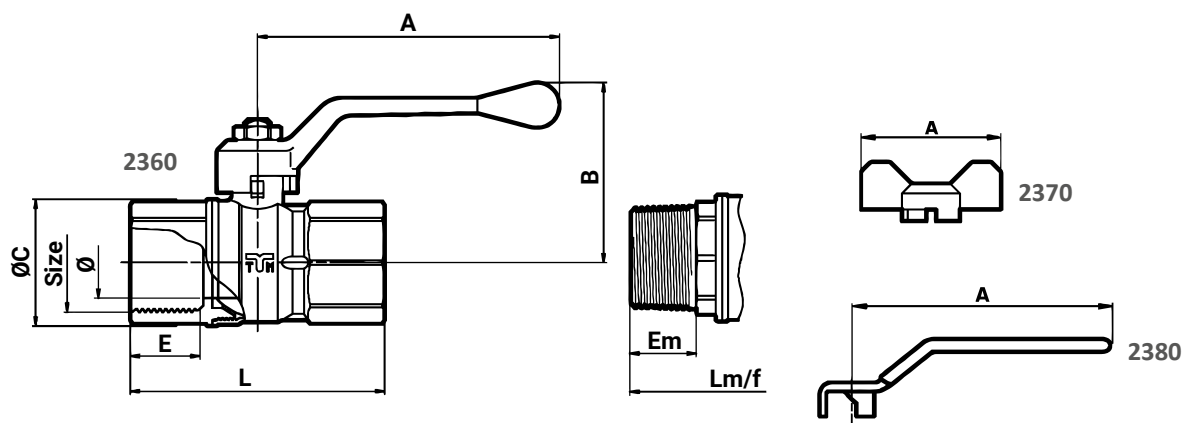

Dimensiune	Mod.	1/2"	3/4"	1"	1" 1/4	1" 1/2	2"
Ø (DN)	toate	14,0	18,0	23,5	30,0	37,5	47,0
A	2360/2361	85,0	85,0	100,0	100,0	140,0	140,0
	2370/2371	50,0	50,0	65,0	65,0	-	-
	2380/2381	85,0	85,0	113,0	113,0	141,0	141,0
B	toate	48,0	52,5	59,5	64,5	76,0	89,0
Ø C	toate	27,5	33,5	42,0	53,0	64,0	79,0
E	ISO7	17,0	18,0	21,5	24,0	24,0	28,5
Em	ISO7	16,5	18,0	21,0	23,5	23,5	28,0
L	ISO7	58,0	66,5	78,0	93,0	101,0	121,0
Lm/f	ISO7	63,5	72,0	83,0	99,1	108,0	129,0
PN		30	30	30	25	25	25

Toate dimensiunile cu exceptia PN-ului sunt exprimate in mm

01A ROBINETI CU SFERA "URAGANO" CU TRECERE TOTALA



2210R

Robineti URAGANO F/F ISO7/EN 10226 cu maneta din aluminiu

Cod	Dimensiune	Pret €	Ambalare
 maneta tip levier rosie			
231 0045	1/4"		25/100
231 0034	3/8"		25/100
220 0012	1/2"		15/60
220 0015	3/4"		10/40
220 0007	1"		8/32
220 0019	1"1/4		4/16
220 0014	1"1/2		3/12
220 0009	2"		2/8
220 0073	2"1/2		1/4
220 0074	3"		1/3
220 0077	4"		1/1
 maneta tip levier neagră			
220 0027	1/2"		20/80
220 0038	3/4"		10/40
220 0017	1"		8/32
220 0032	1"1/4		4/16
220 0018	1"1/2		3/12
220 0010	2"		2/8
220 0079	2"1/2		1/4
220 0081	3"		1/3
220 0082	4"		1/1



2211R



Robineti URAGANO M/F ISO7/EN 10226 cu maneta din aluminiu

Cod	Dimensiune	Pret €	Ambalare
 maneta tip levier rosie			
220 0013	1/2"		20/80
220 0016	3/4"		10/40
220 0008	1"		8/32
220 0039	1"1/4		4/16
220 0037	1"1/2		3/12
220 0030	2"		2/8
 maneta tip levier neagră			
220 0041	1/2"		20/80
220 0051	3/4"		10/40
220 0043	1"		8/32
220 0055	1"1/4		4/16
220 0050	1"1/2		3/12
220 0044	2"		2/8



2220R

Robinet F/F ISO 7/EN10226 cu maneta tip fluture de culoare rosie și neagră



Cod	Dimensiune	Pret €	Ambalare
 maneta tip fluture rosie			
231 0053	1/4"		25/100
231 0020	3/8"		25/100
220 0004	1/2"		20/80
220 0006	3/4"		15/60
220 0023	1"		8/32
 maneta tip fluture neagră			
220 0036	1/2"		25/100
220 0048	3/4"		15/60
220 0063	1"		8/32





2221R

Robinet M/F ISO 7/EN10226 cu maneta tip fluture de culoare rosie și neagră

Cod	Dimensiune	Pret €	Ambalare
 maneta tip fluture rosie			
220 0001	1/2"		20/80
220 0005	3/4"		15/60
220 0011	1"		8/32
 maneta tip fluture neagră			
220 0028	1/2"		25/100
220 0033	3/4"		15/60
220 0059	1"		8/32



2230

Robinet F/F ISO 7/EN 10226 cu maneta de otel de culoare rosie

Cod	Dimensiune	Pret €	Ambalare
231 0051	1/4"		25/100
231 0049	3/8"		25/100
220 0026	1/2"		15/60
220 0034	3/4"		10/40
220 0022	1"		8/32
220 0031	1"1/4		4/16
220 0035	1"1/2		3/12
220 0025	2"		2/8
220 0002	2"1/2		1/4
220 0003	3"		1/3
220 0029	4"		1/1



2231

Robinet M/F ISO 7/EN 10226 cu maneta de otel de culoare rosie

Cod	Dimensiune	Pret €	Ambalare
220 0064	1/2"		20/80
220 0068	3/4"		10/40
220 0053	1"		8/32
220 0062	1"1/4		4/16
220 0066	1"1/2		3/12
220 0054	2"		2/8



2230X

Robinet F/F ISO 7/EN 10226 cu maneta de otel inox de culoare rosie

+ MANETA AISI 304

Cod	Dimensiune	Pret €	Ambalare
220 0148	1/2"		15/60
220 0149	3/4"		10/40
220 0150	1"		8/32
220 0151	1"1/4		4/16
220 0152	1"1/2		3/12
220 0153	2"		2/8
220 0154	2"1/2		1/4
220 0155	3"		1/3
220 0156	4"		1/1



2230V

Robinet F/F ISO 7/EN 10226 cu maneta de otel de culoare verde



+ ANTI - LEGIONELA

Cod	Dimensiune	Pret €	Ambalare
220 0125	1/4"		25/100
220 0126	3/8"		25/100
220 0127	1/2"		15/60
220 0128	3/4"		10/40
220 0129	1"		8/32
220 0130	1"1/4		4/16
220 0131	1"1/2		3/12
220 0132	2"		2/8



2231V

Robinet M/F ISO 7/EN 10226 cu maneta de otel de culoare verde



+ ANTI - LEGIONELA

Cod	Dimensiune	Pret €	Ambalare
220 0136	1/2"		20/80
220 0137	3/4"		10/40
220 0138	1"		8/32
220 0139	1"1/4		4/16
220 0140	1"1/2		3/12
220 0141	2"		2/8

2230V - 2231V FUNCTIONARE

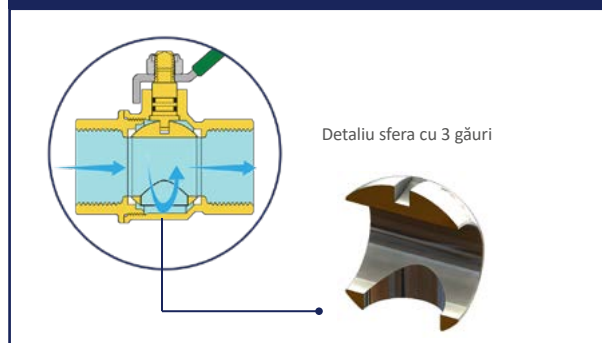

LISTA DE PREȚURI

01_A ROBINETI CU SFERA "URAGANO" CU TRECERE TOTALA

DIMENSIUNI

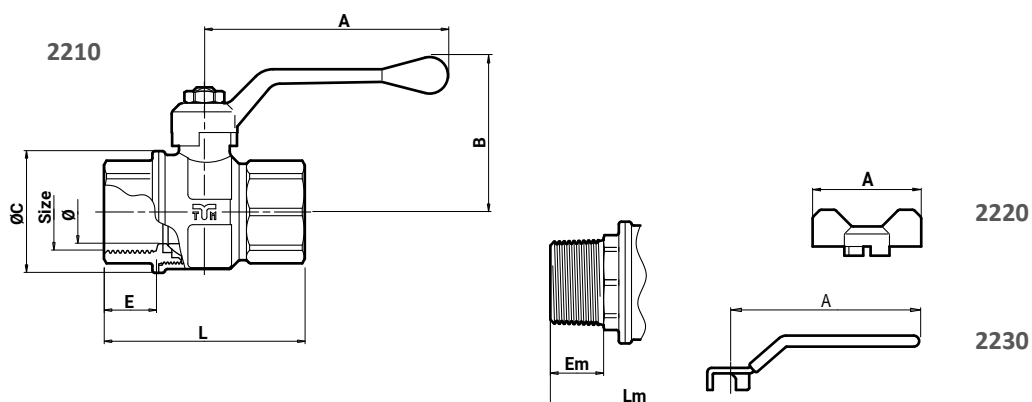

Dimensiune	1/4"	3/8"	1/2"	3/4"	1"	1"1/4	1"1/2	2"	2"1/2	3"	4"
Ø (DN)	10	10	15	20	25	32	40	50	65	80	100
A 2210	85	85	85	100	100	140	140	160	-	-	-
A 2220	50	50	50	65	65	-	-	-	-	-	-
A 2230	85	85	85	113	113	141	141	141	240	240	240
B	39	39	44,5	53,5	57,5	73,5	79,5	92	125,5	136	150,5
ØC	23	23	32,5	39	48	59	71	86	114	131	164
E	10	12	16,5	18	20,6	23,5	23,5	28	34	37	43
L	42	47	59,5	67,5	79	96	105	126	156	177	214
Em	-	-	16,5	18	21	23,5	23,5	28	-	-	-
Lm	-	-	67,5	75,5	87	106	114	136,5	-	-	-
PN	50	50	64	40	40	30	30	30	20	20	20

Toate dimensiunile cu exceptia PN-ului sunt exprimate in mm

01_A ROBINETI CU SFERA "URAGANO" CU TRECERE TOTALA



2232

Robinet pentru izolatie F/F ISO 7/EN 10226 cu maneta de otel de culoare rosie



2233

Robinet pentru izolatie M /F ISO 7/EN 10226 cu maneta de otel de culoare rosie

Cod	Dimensiune	Pret €	Ambalare
220 0192	1/2"		12/48
220 0193	3/4"		8/32
220 0194	1"		6/24
220 0195	1"1/4		3/12
220 0196	1"1/2		2/8
220 0197	2"		1/4

Cod	Dimensiune	Pret €	Ambalare
220 0198	1/2"		12/48
220 0199	3/4"		8/32
220 0200	1"		6/24
220 0201	1"1/4		3/12
220 0202	1"1/2		2/8
220 0203	2"		1/4

DIMENSIUNI

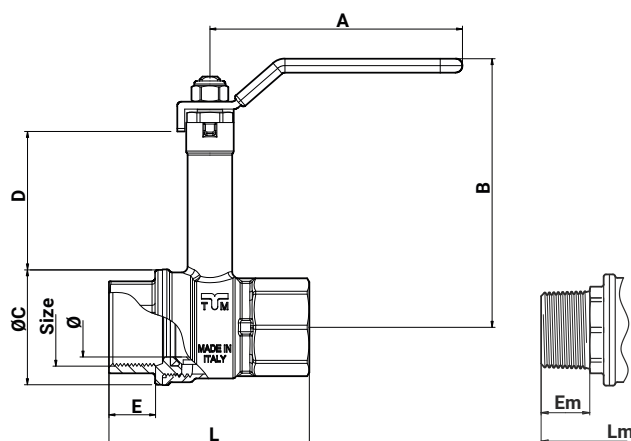

Dimensiune	1/2"	3/4"	1"	1"1/4	1"1/2	2"
Ø (DN)	15	20	25	32	40	50
A	85	85	114	140	140	140
B	88,5	90,5	105,5	131	137	157
ØC	32,5	38,7	48	59	71	86
D	47,8	46,7	47	63	63	75
E	16,5	18	20,6	23,5	23,5	28
L	59,5	67,5	79	95,3	104,5	126
Em	16,5	18	21	23,5	23,5	28
Lm	67,5	75,5	86,6	105,3	113,5	136,5
PN	50	40	40	30	30	25

Toate dimensiunile cu exceptia PN-ului sunt exprimate in mm



01A ROBINETI CU SFERA PENTRU COLECTOARE

Trecere totala



2121

Robinet M/F ISO 228 cu maneta tip fluture de culoare rosie și albastra pentru colectoare și garnitura O-RING

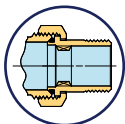

i Disponibil cu maneta tip fluture albastra

Cod	Dimensiune	Pret €	Ambalare
maneta tip fluture rosie			
212 0003	1/2"		20/80
212 0001	3/4"		10/40
212 0002	1"		7/28
212 0004	1"1/4		6/24



2121CP

Robinet M/F ISO 228 cu maneta tip fluture de culoare rosie și albastra pentru colectoare și GARNITURA PLATA

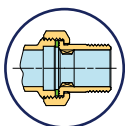

i Disponibil cu maneta tip fluture albastra

Cod	Dimensiune	Pret €	Ambalare
maneta tip fluture rosie			
212 0025	1/2"		20/80
212 0021	3/4"		10/40
212 0015	1"		9/36
212 0024	1"1/4		6/24
212 0122	1"1/2		3/12

Cu maneta aluminiu



2121CPT

Robinet M/F ISO228 cu maner din plastic in forma "T" pentru colectoare și GARNITURA PLATA

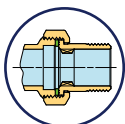

Cod	Dimensiune	Pret €	Ambalare
212 0204	1/2"		10/40
212 0205	3/4"		6/24
212 0206	1"		4/16



2121R

Robinet drept cu olandez și garnitura O-RING, cu pre-etansare

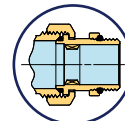

Cod	Dimensiune	Pret €	Ambalare
maneta tip fluture rosie			
212 0155	1/2"		20/80
212 0017	3/4"		10/40
212 0013	1"		9/36
212 0027	1"1/4		6/24
maneta tip fluture albastra			
212 0156	1/2"		20/80
212 0020	3/4"		10/40
212 0014	1"		9/36
212 0028	1"1/4		6/24



2121RSAC

Set robinet drept cu maneta tip fluture de culoare rosie și albastra cu olandez, cu garnitura O-RING cu pre-etansare

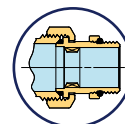

Cod	Dimensiune	Pret €	Ambalare
386 0035	1"		1/10

Nr 1 cu maneta tip fluture de culoare albastra + Nr 1 cu maneta tip fluture de culoare rosie



2180

Robinet M/F de colt ISO 228 cu maneta tip fluture de culoare rosie și albastra pentru colectoare și garnitura O-RING

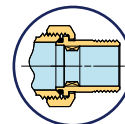

i Disponibil cu maneta tip fluture albastra

Cod	Dimensiune	Pret €	Ambalare
maneta tip fluture rosie			
212 0008	1/2"		15/60
212 0005	3/4"		10/40
212 0006	1"		5/20

Trecere totala



2180CP

Robinet M/F de colt ISO 228 cu maneta tip fluture pentru colectoare si GARNITURA PLATA

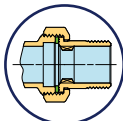

i Disponibil cu maneta tip fluture albastra



Cod	Dimensiune	Pret €	Ambalare
 maneta tip fluture rosie			
212 0035	1/2"		15/60
212 0034	3/4"		10/40
212 0016	1"		5/20

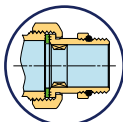

2180CPR

Robinet de colt cu olandez, cu pre-etansare si garnitura GARNITURA PLATA





Cod	Dimensiune	Pret €	Ambalare
 maneta tip fluture rosie			
212 0056	3/4"		10/40
212 0057	1"		5/20
 maneta tip fluture albastra			
212 0054	3/4"		10/40
212 0045	1"		5/20

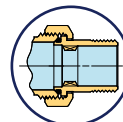

2182

Robinet M/F de colt ISO 228 cu maneta tip fluture pentru colectoare si etansare pe O-RING





Cod	Dimensiune	Pret €	Ambalare
 maneta tip fluture rosie			
212 0046	1/2"		15/60
212 0038	3/4"		10/40
212 0040	1"		5/20
 maneta tip fluture albastra			
212 0047	1/2"		15/60
212 0039	3/4"		10/40
212 0041	1"		5/20

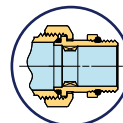

2182R

Robinet M/F de colt ISO 228 cu maneta tip fluture pentru colectoare cu pre-etansare si garnitura O-RING



Cod	Dimensiune	Pret €	Ambalare
 maneta tip fluture rosie			
212 0050	3/4"		10/40
212 0048	1"		5/20
 maneta tip fluture albastra			
212 0049	3/4"		10/40
212 0044	1"		5/20



01A ROBINETI CU SFERA PENTRU COLECTOARE

Trecere totala



2182RSAC

Set robineti M/F de colt ISO 228 cu maneta tip fluture de culoare rosie si albastra pentru colectoare, cu pre-etansare si garnitura O-RING

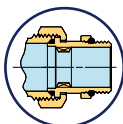

i Nr 1 cu maneta tip fluture de culoare albastra + Nr 1 cu maneta tip fluture de culoare rosie

Cod	Dimensiune	Pret €	Ambalare
386 0032	1"		1/10



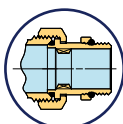

2120R

Robinet drept cu olandez, garnitura O-RING, cu pre-etansare si termometru cu prindere reversibila



BREVETAT

Cod	Dimensiune	Pret €	Ambalare
 maneta tip fluture rosie			
212 0043	1"		5/20
 maneta tip fluture albastra			
212 0042	1"		5/20



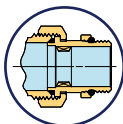

2183R

Robinet M/F de colt ISO 228 cu maneta tip fluture de culoare rosie sau albastra, cu pre-etansare, garnitura O-RING si termometru cu prindere reversibila



BREVETAT

Cod	Dimensiune	Pret €	Ambalare
 maneta tip fluture rosie			
212 0031	1"		5/20
 maneta tip fluture albastra			
212 0032	1"		5/20

TIPOLOGIE OLANDEZI TIEMME

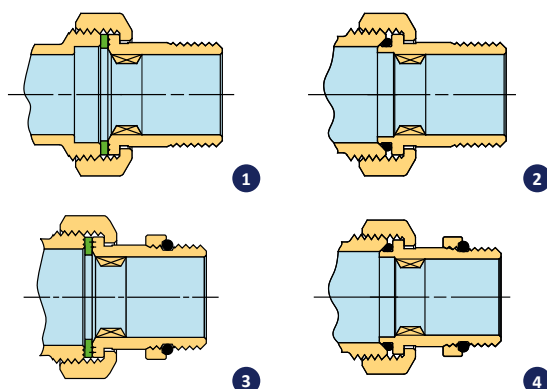

- 1 Olandez cu garnitura plata
- 2 Olandez cu O-Ring
- 3 Olandez cu garnitura plata si pre-etansare
- 4 Olandez cu O-Ring si pre-etansare



2114CPRKIT

Set robineti sfera cu olandez garnitura plata model drept compact, cu maneta tip fluture culoare rosie si albastra si termometre ce au conexiune reversibila

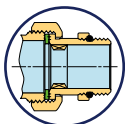

 BREVETAT

Cod	Dimensiune	Pret €	Ambalare
212 0195	1"		1/10



2184CPRKIT

Set robineti sfera cu olandez garnitura plata model coltar compact, cu maneta tip fluture culoare rosie si albastra si termometre ce au conexiune reversibila

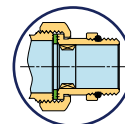

 BREVETAT

Cod	Dimensiune	Pret €	Ambalare
212 0197	1"		1/10



2116CPRKIT

Set robineti sfera cu olandez garnitura plata model drept compact, cu maneta tip fluture culoare rosie si albastra fara termometre

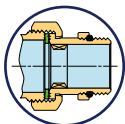

 BREVETAT

Cod	Dimensiune	Pret €	Ambalare
212 0196	1"		1/10



2186CPRKIT

Set robineti sfera cu olandez garnitura plata model coltar compact, cu maneta tip fluture culoare rosie si albastra fara termometre

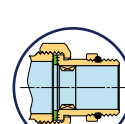

 BREVETAT

Cod	Dimensiune	Pret €	Ambalare
212 0198	1"		1/10



Pentru tub multistrat



2143

Robinet pentru tub multistrat cu maneta de aluminiu de culoare rosie

i Disponibil cu maneta de otel de culoare rosie (2163)

Cod	Dimensiune	Pret €	Ambalare
162 0022	16 x 2,0		20/80
162 0005	20 x 2,0		15/60



2153

Robinet pentru tub multistrat cu maneta tip fluture de culoare rosie și albastra

i Disponibil cu maneta tip fluture albastra

Cod	Dimensiune	Pret €	Ambalare
maneta tip fluture rosie			
162 0020	16 x 2,0		20/80
162 0003	20 x 2,0		15/60
162 0084	26 x 3,0		10/40
maneta tip fluture albastra			
162 0021	16 x 2,0		20/80
162 0053	20 x 2,0		15/60
162 0086	26 x 3,0		10/40



2153FLR

Robinet pentru tub multistrat cu maneta tip fluture de culoare rosie și albastra

Cod	Dimensiune	Pret €	Ambalare
maneta tip fluture rosie			
162 0029	16 x 2,0		20/80
162 0031	20 x 2,0		15/60
maneta tip fluture albastra			
162 0030	16 x 2,0		20/80
162 0032	20 x 2,0		15/60



2154R

Robinet M pentru tub multistrat cu maneta tip fluture de culoare rosie și albastra

Cod	Dimensiune	Pret €	Ambalare
maneta tip fluture rosie			
162 0025	16 x 2,0 - 1/2"		20/80
162 0037	20 x 2,0 - 3/4"		15/60
162 0092	26 x 3,0 - 1"		10/40
maneta tip fluture albastra			
162 0026	16 x 2,0 - 1/2"		20/80
162 0038	20 x 2,0 - 3/4"		15/60
162 0093	26 x 3,0 - 1"		10/40



2154FLR

Robinet M pentru tub multistrat cu maneta tip fluture de culoare rosie și albastra



Cod	Dimensiune	Pret €	Ambalare
maneta tip fluture rosie			
162 0035	16 x 2,0 - 1/2"		20/80
162 0041	20 x 2,0 - 3/4"		15/60
maneta tip fluture albastra			
162 0036	16 x 2,0 - 1/2"		20/80
162 0042	20 x 2,0 - 3/4"		15/60

Pentru tub multistrat



2155R



Robinet F pentru tub multistrat cu maneta tip fluture de culoare rosie și albastra

Cod	Dimensiune	Pret €	Ambalare
 maneta tip fluture rosie			
162 0027	16 x 2,0 - 1/2"		20/80
162 0039	20 x 2,0 - 3/4"		15/60
162 0100	26 x 3,0 - 1"		10/40
 maneta tip fluture albastra			
162 0028	16 x 2,0 - 1/2"		20/80
162 0040	20 x 2,0 - 3/4"		15/60
162 0101	26 x 3,0 - 1"		10/40



2155FLR



Robinet F pentru tub multistrat cu maneta tip fluture de culoare rosie și albastra

Cod	Dimensiune	Pret €	Ambalare
 maneta tip fluture rosie			
162 0033	16 x 2,0 - 1/2"		20/80
162 0043	20 x 2,0 - 3/4"		15/60
 maneta tip fluture albastra			
162 0034	16 x 2,0 - 1/2"		20/80
162 0044	20 x 2,0 - 3/4"		15/60



2161



Robinet pentru tub multistrat cu maneta de aluminiu si piulita

Cod	Dimensiune	Pret €	Ambalare
 maneta tip levier rosie			
162 0122	26 x 3,0 - 3/4"		10/40
162 0124	26 x 3,0 - 1"		10/40
 maneta tip levier albastra			
162 0121	26 x 3,0 - 3/4"		10/40
162 0123	26 x 3,0 - 1"		10/40



2160



Robinet pentru tub multistrat cu maneta tip fluture si piulita

Cod	Dimensiune	Pret €	Ambalare
 maneta tip fluture rosie			
162 0112	16 x 2,0 - 1/2"		20/80
162 0114	16 x 2,0 - 3/4"		15/60
162 0116	20 x 2,0 - 3/4"		15/60
162 0118	26 x 3,0 - 3/4"		10/40
162 0120	26 x 3,0 - 1"		10/40
 maneta tip fluture albastra			
162 0111	16 x 2,0 - 1/2"		20/80
162 0113	16 x 2,0 - 3/4"		15/60
162 0115	20 x 2,0 - 3/4"		15/60
162 0117	26 x 3,0 - 3/4"		10/40
162 0119	26 x 3,0 - 1"		10/40



2156R

Robinet M de colt pentru tub multistrat cu maneta tip fluture de culoare rosie și albastra

Cod	Dimensiune	Pret €	Ambalare
 maneta tip fluture rosie			
162 0051	20 x 2,0 - 3/4"		15/60
 maneta tip fluture albastra			
162 0052	20 x 2,0 - 3/4"		15/60



LISTA DE PREȚURI



01A ROBINETI CU CAPETE DE COMPRESIUNE/PRESARE

Pentru tub multistrat



2157R

Robinet de colt pentru tub multistrat cu maneta tip fluture de culoare rosie, albastra si piulita



Cod	Dimensiune	Pret €	Ambalare
 maneta tip fluture rosie			
162 0047	20 x 2,0 - 3/4"		10/40
162 0060	20 x 2,0 - 1"		10/40
162 0049	26 x 3,0 - 3/4"		10/40
162 0062	26 x 3,0 - 1"		10/40
 maneta tip fluture albastra			
162 0048	20 x 2,0 - 3/4"		10/40
162 0061	20 x 2,0 - 1"		10/40
162 0050	26 x 3,0 - 3/4"		10/40
162 0063	26 x 3,0 - 1"		10/40

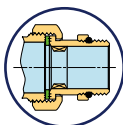

2181CPR

Robinet de colt cu olandez si GARNITURA PLATA



Cod	Dimensiune	Pret €	Ambalare
 maneta tip fluture rosie			
162 0045	20 x 3/4"		10/40
162 0014	26 x 3/4"		10/40
162 0010	26 x 1"		5/20
162 0015	32 x 1"		5/20
 maneta tip fluture albastra			
162 0046	20 x 3/4"		10/40
162 0004	26 x 3/4"		10/40
162 0009	26 x 1"		5/20
162 0013	32 x 1"		5/20



1697

Robinet presare drept cu maneta tip fluture de culoare rosie sigilabila si piulita

Cod	Dimensiune	Pret €	Ambalare
168 0021	20 x 3/4"		20/80
168 0035	25 x 3/4"		20/80
168 0030	26 x 3/4"		20/80
168 0032	32 x 1"		10/40



1697CK

Robinet presare drept cu maneta tip fluture de culoare rosie sigilabila, piulita si supapa de sens



 Directie flux

Cod	Dimensiune	Pret €	Ambalare
168 0029	20 x 3/4"		20/80
168 0027	25 x 3/4"		20/80
168 0036	26 x 3/4"		20/80
168 0037	32 x 1"		10/40



1691

Robinet presare cu sfera cu maneta tip fluture

Cod	Dimensiune	Pret €	Ambalare
168 0010	16 x 16		5/50
168 0065	18 x 18		5/50
168 0007	20 x 20		5/50
168 0025	25 x 25		5/50
168 0008	26 x 26		5/50
168 0087	32 x 32		5/30

 Noutati

Pentru tub multistrat



1692

Robinet presare de colt cu maneta tip fluture de culoare rosie, albastra si piulita

i Disponibil cu maneta tip fluture albastra

Cod	Dimensiune	Pret €	Ambalare
 maneta tip fluture rosie			
168 0077	16 x 3/4"		10/40
168 0019	20 x 3/4"		10/40
168 0028	25 x 3/4"		10/40
168 0020	26 x 3/4"		10/40
168 0034	32 x 1"		10/40



1692CK

Robinet presare de colt cu maneta tip fluture de culoare rosie, piulita si supapa de sens



i ↗ Directie flux

Cod	Dimensiune	Pret €	Ambalare
168 0026	20 x 3/4"		10/40
168 0018	25 x 3/4"		10/40
168 0031	26 x 3/4"		10/40
168 0022	32 x 1"		10/40



1690

Robinet presare cu sfera de incastrat



i Pentru accesorii vezi pag. 44

Cod	Dimensiune	Pret €	Ambalare
168 0002	16 x 16		5/50
168 0004	18 x 18		5/50
168 0001	20 x 20		5/50
168 0009	25 x 25		5/50
168 0003	26 x 26		5/50



1690U

Robinet presare cu sfera de incastrat "U"



i Pentru accesorii vezi pag. 44

Cod	Dimensiune	Pret €	Ambalare
168 0013	16 x 16		1/25
168 0011	20 x 20		1/25
168 0016	25 x 25		1/25
168 0033	26 x 26		1/25



1696

Robinet presare cu obertein de incastrat 2 cai



i Pentru accesorii vezi pag. 44

Cod	Dimensiune	Pret €	Ambalare
168 0012	16 x 16		5/50
168 0017	18 x 18		5/50
168 0014	20 x 20		5/50
168 0024	25 x 25		5/50
168 0023	26 x 26		5/50

01A ROBINETI CU CAPETE DE COMPRESIUNE

Pentru tub cupru



2142

Robinet cu capete de compresie CUPRU cu maneta rosie, de aluminiu

Cod	Dimensiune	Pret €	Ambalare
214 0004	15		15/60
214 0008	18		15/60
214 0002	22		10/40
214 0005	28		7/28



2152

Robinet cu capete de compresie CUPRU cu maneta rosie, tip fluture

Cod	Dimensiune	Pret €	Ambalare
214 0003	15		15/60
214 0006	18		15/60
214 0001	22		10/40
214 0007	28		7/28



2263
Robinet drept F ISO 228 cu piulita

Cod	Dimensiune	Pret €	Ambalare
226 0002	1/2" x 1/2"		10/60
226 0001	3/4" x 3/4"		10/60
226 0003	1" x 1"		10/40
226 0044	1/2" x 3/4"		20/80
226 0020	1/2" x 3/4"		20/80
226 0021	3/4" x 1"		10/40

Versiunea nichelata



2263CK
Robinet drept F ISO 228 cu piulita si supapa de sens





i ↗ Directie flux

Cod	Dimensiune	Pret €	Ambalare
226 0004	1/2" x 1/2"		20/80
226 0005	3/4" x 3/4"		20/80
226 0006	1" x 1"		10/40
226 0022	1/2" x 3/4"		20/80
226 0023	3/4" x 1"		10/40

Versiunea nichelata





2266
Robinet drept M ISO 228 cu piulita

Cod	Dimensiune	Pret €	Ambalare
 maneta tip fluture rosie			
226 0050	1/2" M ISO7 x 1/2" F		20/80
226 0049	1/2" M ISO7 x 3/4" F		20/80
226 0010	3/4" M - 3/4" F		20/80
226 0012	3/4" M - 1" F		10/40
 maneta tip fluture neagra			
226 0048	1/2" M ISO7 - 1/2" F		20/80
226 0047	1/2" M ISO7 - 3/4" F		20/80
226 0046	3/4" M - 3/4" F		20/80

NOU TATI



2281
Robinet drept M ISO 228 cu piulita si maneta tip fluture

Cod	Dimensiune	Pret €	Ambalare
 maneta tip fluture rosie			
226 0140	3/4" M - 3/4" F		10/60
226 0145	1" M - 3/4" F		8/48
 maneta tip fluture albastra			
226 0141	3/4" x 3/4"		10/60
226 0146	1" M - 3/4" F		8/48
 maneta tip fluture neagra			
226 0196	3/4" x 3/4"		10/60

La cerere

NOU TATI



2285
Robinet drept F ISO 228 cu piulita si maneta tip fluture

Cod	Dimensiune	Pret €	Ambalare
 maneta tip fluture neagra			
226 0198	3/4" F - 1" F		8/48
226 0197	1" F - 1" F		8/48

La cerere



2266CK
Robinet drept M ISO 228 cu piulita si supapa de sens



i ↗ Directie flux

Cod	Dimensiune	Pret €	Ambalare
226 0011	3/4" M - 3/4" F		20/80
226 0013	3/4" M - 1" F		10/40



LISTA DE PRETURI



2224N

Robinet de colt M ISO7/EN 10226 cu piulita si maneta tip fluture neagra

Cod	Dimensiune	Pret €	Ambalare
226 0031	1/2" M x 1/2" F		20/80
226 0032	1/2" M x 3/4" F		20/80
226 0030	3/4" M x 3/4" F		10/40



2228

Robinet de colt M cu piulita si maneta tip fluture

Disponibil cu maneta tip fluture albastra

Cod	Dimensiune	Pret €	Ambalare
maneta tip fluture rosie			
226 0153	1/2" x 1/2"		20/80
226 0155	3/4" x 3/4"		15/60
226 0157	3/4" x 1"		15/60
226 0159	1" x 1"		10/40



2229

Robinet de colt F cu piulita si maneta tip fluture

Disponibil cu maneta tip fluture albastra

Cod	Dimensiune	Pret €	Ambalare
maneta tip fluture rosie			
226 0161	1/2" x 1/2"		20/80
226 0163	3/4" x 3/4"		15/60
226 0165	3/4" x 1"		15/60
226 0167	1" x 1"		10/40



2266SP

Robinet drept M ISO 228 cu piulita, drenaj si maneta tip fluture

Cod	Dimensiune	Pret €	Ambalare
maneta tip fluture rosie			
226 0127	3/4" x 3/4"		15/60
maneta tip fluture albastra			
226 0128	3/4" x 3/4"		15/60

NOUȚĂȚI



2320AF
Robinet SCIROCCO F/F ISO 228
cu maneta fluture anti-frauda

i Maneta din alamă

+ Anti-frauda

Cod	Dimensiune	Pret €	Ambalare
231 0274	1/2"		25/75
231 0359	1"		10/30

NOUȚĂȚI



2370AF
Robinet MISTRAL F/F ISO 228 cu
maneta fluture anti-frauda

i Maneta din alamă

+ Anti-frauda

Cod	Dimensiune	Pret €	Ambalare
236 0227	1/2"		25/100
236 0228	3/4"		15/60
236 0230	1"		10/30

NOUȚĂȚI



2258AF
Robinet cu sfera filet interior
ISO 228 cu piulita semiolandez
cu filtru si maneta fluture anti-
frauda

i Maneta din alamă

+ Anti-frauda

Cod	Dimensiune	Piuliță semiolandez	Pret €	Ambalare
226 0098	3/4"	3/4"		10/40

NOUȚĂȚI



2263AF
Robineti cu sfera filet F ISO
228 si piulita libera cu maneta
fluture anti-frauda

i Maneta din alamă

+ Anti-frauda

Cod	Dimensiune	Piuliță semiolandez	Pret €	Ambalare
226 0065	1/2"	3/4"		15/60
226 0066	3/4"	3/4"		15/60
226 0064	3/4"	1"		10/40
226 0063	1"	1"		10/40

La cerere



2266OT
Robinet cu sfera filet masculin
ISO 228 si piulita cu maneta din
alama

i Filet exterior cu fata plana

Cod	Dimensiune	Pret €	Ambalare
226 0028	3/4"		15/60

NOUȚĂȚI



2266OTW
Robinet cu sfera filet masculin
ISO 228 si piulita cu maneta din
alama

i Maneta din alamă

Cod	Dimensiune	Piuliță semiolandez	Pret €	Ambalare
226 0053	1/2"	3/4"		15/60
226 0058	3/4"	3/4"		15/60
226 0052	3/4"	1"		10/40
226 0051	1"	1"		10/40

NOUȚĂȚI



2284SPCK
Robinet cu sfera pentru
contoare, cu filet exterior
conform ISO228, piulita
semiolandez, cu posibilitate de
purjare - Livrat cu supapa de
retinere



i ↗ Direcția fluxului

i Maneta din alamă

+ Supapă de retinere

+ Blocabil

Cod	Dimensiune	Piuliță semiolandez	Pret €	Ambalare
226 0206	3/4"	3/4"		12/48



LISTA DE PREȚURI

NOUȚĂȚI



2266AF

Robinet cu sfera filet masculin ISO 228 si piulita libera cu maneta fluture anti-frauda

Maneta din alamă

Anti-frauda

Cod	Dimensiune	Piuliță semiolandez	Pret €	Ambalare
226 0057	1/2"	3/4"		15/60
226 0054	3/4"	3/4"		15/60
226 0056	3/4"	1"		10/40
226 0055	1"	1"		10/40

NOUȚĂȚI



2266LAF

Robineti cu sfera filet masculin ISO 228 si piulita libera cu maneta fluture anti-frauda

Maneta din alamă

Anti-frauda

Cod	Dimensiune	Piuliță semiolandez	Pret €	Ambalare
226 0087	3/4"	3/4"		15/60

NOUȚĂȚI



2267OT

Robinet cu sfera pentru tub PE si piulita cu maneta din alama

Cod	Tub PE	Piuliță semiolandez	Pret €	Ambalare
226 0075	Ø 25	3/4"		10/40
226 0117	Ø 25	1"		8/32
226 0132	Ø 32	3/4"		8/32
226 0133	Ø 32	1"		7/28
226 0116	Ø 40	1" 1/2		4/16
226 0126	Ø 50	2"		2/8

La cerere

NOUȚĂȚI



2267AF

Robinet cu sfera pentru tub PE si piulita libera cu maneta fluture anti-frauda

Maneta din alamă

Anti-frauda

Cod	Tub PE	Piuliță semiolandez	Pret €	Ambalare
226 0080	Ø 25	3/4"		10/40
226 0118	Ø 32	3/4"		8/32
226 0119	Ø 32	1"		7/28
226 0121	Ø 40	1" 1/2		4/16
226 0123	Ø 50	2"		2/8

La cerere



2277

Robinet cu sfera pentru tub PE cu tija de manevra 28 mm

Cod	Tub PE	Pret €	Ambalare
226 0136	Ø 25		8/32

NOUȚĂȚI



2273AF

Robinet drept M ISO 228 si piulita libera cu maneta fluture anti-frauda

Maneta din aluminiu

Anti-frauda

Cod	Dimensiune	Piuliță semiolandez	Pret €	Ambalare
226 0131	1/2"	3/4"		10/40

NOUȚĂȚI



2272LAF

Robinet coltar cu sfera pentru tub PE anti-frauda

Compatibil cu maneta din aluminiu antifurt

Cod	Tub PE	Piuliță semiolandez	Pret €	Ambalare
226 0088	Ø 25	3/4"		10/40
226 0124	Ø 32	3/4"		5/20
226 0125	Ø 32	1"		5/20

NOUȚĂȚI



2246

Robinet nichelat tip coltar cu sfera pentru apa cu racord pentru PE/piulita semiolandez si maneta din plastic rosie

i Maneta din plastic

Cod	Tab PE	Piuliță semiolandez	Pret €	Ambalare
226 0105	Ø 20	3/4"		10/40
226 0106	Ø 25	3/4"		10/40

NOUȚĂȚI



2245

Robinet cu sfera racord PE/filet exterior si maneta din plastic rosie

i Maneta din plastic

Cod	Tab PE	Dimensiune	Pret €	Ambalare
226 0103	Ø 20	1/2"		15/60
226 0104	Ø 25	3/4"		10/60

La cerere

NOUȚĂȚI



2247CK

Robinet nichelat tip coltar cu sfera pentru apa cu filet exterior/piulita semiolandez, supapa de retinere si maneta din plastic rosie



i ↗ Direcția fluxului

i Maneta din plastic

Cod	Dimensiune	Piuliță semiolandez	Pret €	Ambalare
226 0107	3/4"	3/4"		10/40

NOUȚĂȚI



2264AF

Robinet cu sfera filet interior ISO228 cu racord semiolandez telescopic (15mm) si maneta anti-frauda

i Maneta din alamă

+ Anti-frauda

Cod	Dimensiune	Piuliță semiolandez	Pret €	Ambalare
226 0070	3/4"	3/4"		10/40
226 0069	1"	1"		10/40

La cerere

NOUȚĂȚI



2265AF

Robinet cu sfera filet exterior cu racord semiolandez telescopic (15mm), conform ISO228, cu maneta anti-frauda

i Maneta din alamă

+ Anti-frauda

Cod	Dimensiune	Piuliță semiolandez	Pret €	Ambalare
226 0074	3/4"	3/4"		10/40
226 0073	1"	1"		10/40

La cerere

2264AF - 2265AF

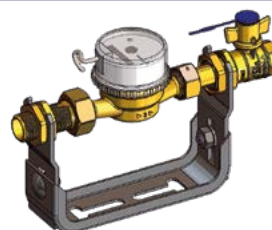

Robinetul trebuie fixat corespunzător pentru a preveni acțiunea forțelor laterale asupra manșonului extensibil

NOUȚĂȚI



2279AF

Robinet cu sfera filet interior ISO228 cu racord semiolandez telescopic, cu maneta anti-frauda

i Maneta din alamă

+ Anti-frauda

Cod	Dimensiune	Piuliță semiolandez	Pret €	Ambalare
226 0199	1/2"	3/4"		12/48
226 0183	3/4"	3/4"		12/48

La cerere

NOUȚĂȚI



2283AF

Robinet cu sfera filet exterior ISO228 cu racord semiolandez telescopic, cu maneta anti-frauda

i Maneta din alamă

+ Anti-frauda

Cod	Dimensiune	Piuliță semiolandez	Pret €	Ambalare
226 0210	1/2"	3/4"		12/48
226 0185	3/4"	3/4"		12/48



LISTA DE PREȚURI

NOUȚĂȚI



2266AFCH
Cheie pentru maneta anti-fraudă

BREVETAT

Cod	Lungimea	Pret €	Ambalare
296 0085	60 mm		1/40
296 0148	180 mm		1/20

NOUȚĂȚI



2263SET
Kit maneta fluture anti-frauda

BREVETAT

Cod	Dimensiune	Pret €	Ambalare
226 0083	-		1/25

NOUȚĂȚI



2266AFCO
Kit colier anti-frauda pentru piulita

BREVETAT

Cod	Dimensiune	Pret €	Ambalare
296 0117	3/4"		1/40
296 0188	1"		1/30
296 0187	1"1/4		1/25
296 0189	1"1/2		1/20
296 0190	2"		1/20

NOUȚĂȚI



H9602
Piulita pentru maneta fluture anti-frauda

Cod	Dimensiune	Pret €	Ambalare
040 0268	M7 x 1		10/1500
040 0269	M9 x 1,25		10/1500

NOUȚĂȚI



H9604
Surub pentru colier anti-frauda (Art. 2266AFCO)

Cod	Dimensiune	Pret €	Ambalare
040 0270	M8 x 10		10/1000

La cerere

FLUXUL DE APĂ ESTE DESCHIS

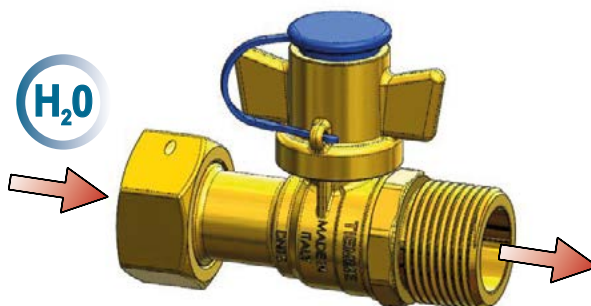

INSTRUCȚIUNI PENTRU MANETA ANTI-FRAUDĂ

1 Oprii fluxul de apă

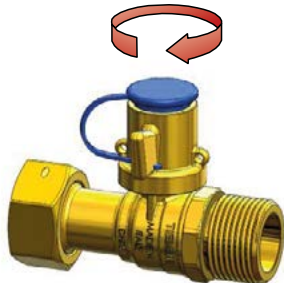

2 Îndepărtați capacul

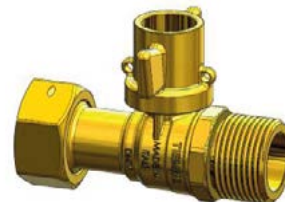

3 Introduceți cheia specială pentru a prinde piulița și a atinge pârghia cu inelul exterior al cheii

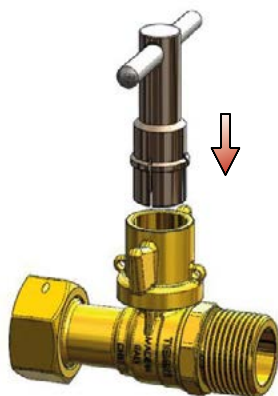

4 Deșurubați

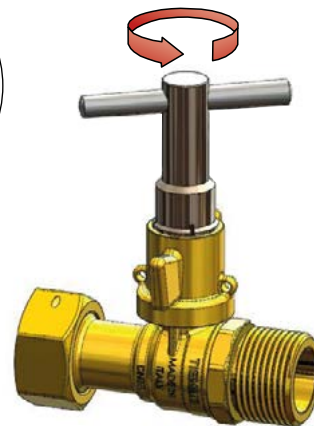
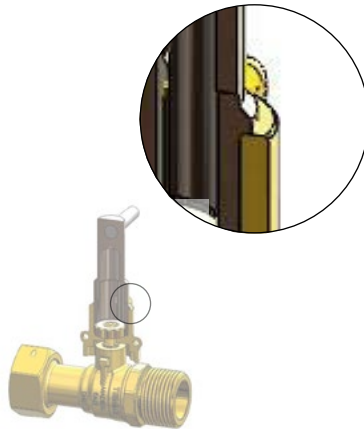

5 Extrageți piulița și maneta în formă de «T»

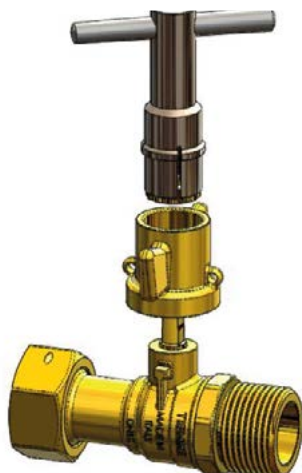

6 Introduceți maneta în formă de «T» în poziția de închidere



7 Introduceți cheia specială și fixați piulița

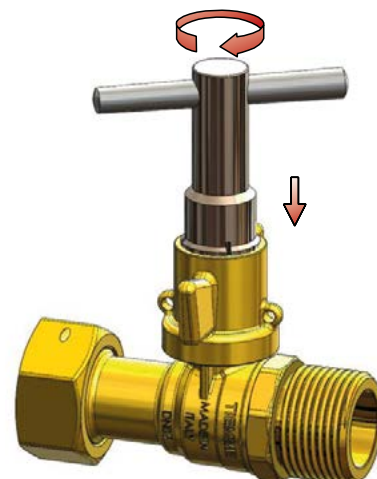



2270
Robinet URAGANO F/F ISO 7/EN 10226 cu tija de manevra 28 mm

i Maneta din alamă de □ 28 mm

+ Sigilabil

Cod	Dimensiune	Pret €	Ambalare
220 0204	1/2"		15/60
220 0166	3/4"		10/40
220 0167	1"		8/32
220 0168	1" 1/4		4/16
220 0169	1" 1/2		3/12
220 0170	2"		2/8



2271
Robinet URAGANO M/F ISO 7/EN 10226 cu tija de manevra 28 mm

i Maneta din alamă de □ 28 mm

+ Sigilabil

Cod	Dimensiune	Pret €	Ambalare
220 0205	1/2"		15/60
220 0177	3/4"		10/40
220 0178	1"		8/32
220 0179	1" 1/4		4/16
220 0180	1" 1/2		3/12
220 0181	2"		2/8



2340
Robinet SCIROCCO F/F ISO 228 cu tija de manevra 28 mm

i Maneta din alamă de □ 28 mm

+ Sigilabil

Cod	Dimensiune	Pret €	Ambalare
231 0275	1/2"		15/60

NOUȚĂȚI



2266QU
Robinet cu sfera "URAGANO" cu file exterior/piulita semiolandez cu tija de manevra 28mm

i Maneta din alamă de □ 28 mm

+ Sigilabil

Cod	Dimensiune	Piuliță semiolandez	Pret €	Ambalare
226 0100	2"	2"		2/8

2266QU CARACTERISTICI TEHNICE

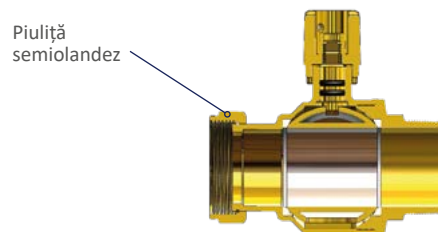

NOUȚĂȚI



2271Q32
Robinet cu sfera "URAGANO" cu file exterior/interior conform ISO7/EN 10226 cu tija de manevra 32mm

i Maneta din alamă de □ 32 mm

Cod	Dimensiune	Pret €	Ambalare
220 0165	1" 1/4		3/12

NOUȚĂȚI



2266LP
Robinet cu sfera "URAGANO" cu file exterior/piulita semiolandez cu maneta plata rosie plastificata

i Maneta de oțel

Cod	Dimensiune	Piuliță semiolandez	Pret €	Ambalare
226 0099	2"	2"		2/8

2266LP CARACTERISTICI TEHNICE

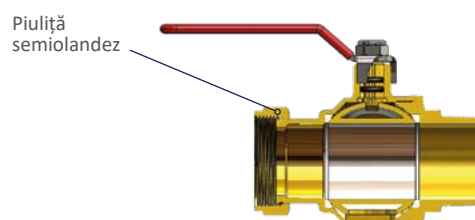



2510
Robinet portfurtun cu maneta de aluminiu de culoare rosie și neagră

Cod	Dimensiune	Pret €	Ambalare
maneta tip levier rosie			
250 0012	3/8"		12/48
250 0001	1/2"		12/48
250 0003	3/4"		7/28
250 0004	1"		4/16
maneta tip levier neagră			
250 0042	3/8"		12/48
250 0043	1/2"		12/48
250 0044	3/4"		7/28
250 0045	1"		4/16



2520
Robinet portfurtun cu maneta tip fluture de culoare rosie

i Disponibil cu maneta tip fluture albastra

Cod	Dimensiune	Pret €	Ambalare
maneta tip fluture rosie			
250 0007	1/2"		12/48



2584
Robinet cu sfera cu maneta sigilabila

Cod	Dimensiune	Pret €	Ambalare
250 0009	1/2"		12/48



2530X316
Robinet cu sfera cu port-furtun si maneta din inox AISI 316 gri plata

+ MANETA AISI 316

Cod	Dimensiune	Pret €	Ambalare
250 0061	1/2"		10/40



2511B
Robinet EOLO NO FROST portfurtun cu maneta de aluminiu de culoare albastra

+ NO FROST

Cod	Dimensiune	Pret €	Ambalare
250 0075	1/2"		25/50
250 0076	3/4"		20/40



2512B
Robinet EOLO NO FROST portfurtun cu maneta de aluminiu de culoare albastra

+ NO FROST

Cod	Dimensiune	Pret €	Ambalare
250 0102	1/2"		25/50
250 0104	3/4"		20/40



2535V
Robinet EOLO DUPLEX NO FROST portfurtun cu maneta verde plata

+ NO FROST

Cod	Dimensiune	Pret €	Ambalare
250 0062	1/2"		5/20



2585G
Robinet portfurtun serie
"masiva"

Cod	Dimensiune	Pret €	Ambalare
258 0001	1/2"		1/25
258 0003	3/4"		1/20
258 0007	1"		4/16



2588C
Robinet cromat serie "masiva"

Cod	Dimensiune	Pret €	Ambalare
258 0043	1/2"		1/25
258 0049	3/4"		1/20



2900
Mini-robinet F/F cu maneta de culoare neagră

Cod	Dimensiune	Pret €	Ambalare
290 0022	1/4"		30/180
290 0016	3/8"		25/150
290 0006	1/2"		20/120



2901
Mini-robinet M/F cu maneta de culoare neagră

Cod	Dimensiune	Pret €	Ambalare
290 0011	1/4"		30/180
290 0004	3/8"		25/150
290 0001	1/2"		20/120



2902
Mini-robinet M/M cu maneta de culoare neagră

Cod	Dimensiune	Pret €	Ambalare
290 0045	1/4"		30/180
290 0031	3/8"		25/150
290 0008	1/2"		20/120



2940
Mini-robinet CU/F cu maneta de culoare neagră

Cod	Dimensiune	Pret €	Ambalare
290 0033	10 x 1/2"		20/120
290 0034	12 x 1/2"		20/120
290 0030	15 x 1/2"		15/90
290 0041	16 x 1/2"		15/90



2942
Mini-robinet CU/CU cu maneta de culoare neagră

Cod	Dimensiune	Pret €	Ambalare
290 0012	10 x 10		20/120
290 0005	12 x 12		20/120
290 0059	14 x 14		20/120
290 0007	15 x 15		15/90
290 0060	16 x 16		15/90



2931
Mini-robinet cu sfera SMALL M/F cu fanta pentru surubelnita

Cod	Dimensiune	Pret €	Ambalare
290 0019	3/8"		25/150



2932
Mini-robinet cu sfera SMALL M/M cu fanta pentru surubelnita

Cod	Dimensiune	Pret €	Ambalare
290 0056	3/8"		40/240
290 0054	1/2"		25/150





LISTA DE PRETURI



2944



Minirobinet cu sfera pentru tub multistrat cu maneta aluminiu de culoare rosie sau albastra

Cod	Dimensiune	Pret €	Ambalare
 maneta tip fluture rosie			
294 0029	16 x 2,0 - 1/2"		25/100
 maneta tip fluture albastra			
294 0028	16 x 2,0 - 1/2"		25/100



2945



Minirobinet cu sfera pentru tub de cupru cu maneta aluminiu de culoare rosie sau albastra

Cod	Dimensiune	Pret €	Ambalare
 maneta tip fluture rosie			
294 0020	15 - 1/2"		25/100
294 0018	16 - 1/2"		25/100
294 0035	18 - 1/2"		25/100
 maneta tip fluture albastra			
294 0019	15 - 1/2"		25/100
294 0016	16 - 1/2"		25/100
294 0034	18 - 1/2"		25/100



2947

Minirobinet cu sfera pentru tub Pex cu maneta aluminiu de culoare rosie sau albastra

Cod	Dimensiune	Pret €	Ambalare
 maneta tip fluture rosie			
294 0002	16 x 2,0 - 1/2"		25/100
 maneta tip fluture albastra			
294 0001	16 x 2,0 - 1/2"		25/100



2941

Minirobinet cu sfera filet M si piulita semiolandez, cu maneta din aluminiu rosie pentru colectoare



Fata dreapta (plana)

Cod	Dimensiune	Pret €	Ambalare
294 0054	1/2" x 1/2"		25/100



2946GR

Minirobinet M/F pentru colectoare cu maneta din plastic rosie sau albastra

Cod	Dimensiune	Pret €	Ambalare
 maneta tip fluture rosie			
294 0010	1/2" - 1/2"		25/100
 maneta tip fluture albastra			
294 0009	1/2" - 1/2"		25/100



2139

Robinet cu sfera motorizat, cu trecere totala, cu 2 cai F/F, pentru actuator cu baza ISO5211

Cod	Dimensiune	Pret €	Ambalare
213 0104	1/2"		15/60
213 0107	3/4"		10/40
213 0108	1"		7/28



2138

Robinet cu sfera, motorizat cu 2 iesiri M/F

i Disponibil si cu alimentare 24 Vac

Cod	Dimensiune	Aliment.	Pret €	Ambalare
213 0020	1/2"	230 Vac		1/14
213 0003	3/4"	230 Vac		1/14
213 0007	1"	230 Vac		1/14
213 0019	1"1/4	230 Vac		1/14



2133

Robinet cu sfera, motorizat cu 2 iesiri M/M

i Disponibil si cu alimentare 24 Vac

Cod	Dimensiune	Aliment.	Pret €	Ambalare
213 0011	3/4"	230 Vac		1/14
213 0016	1"	230 Vac		1/14



9535

Servomotor pentru robinet cu 2 cai (art. 2138-2133); rotatie monodirectionala cu unghi de 90° dotat cu siguranta de protectie. Carcasa cu grad de protectie IP44

Cod	Tensiune	Timp manevra	Pret €	Ambalare
213 0024	230 Vac	30 sec		1/8
213 0072	24 Vac	30 sec		1/8



2134

Robinet cu sfera, motorizat cu 3 cai deviator, cu 3 intrari

i Disponibil si cu alimentare 24 Vac

Cod	Dimensiune	Aliment.	Pret €	Ambalare
213 0009	3/4"	230 Vac		1/4
213 0018	1"	230 Vac		1/4



9537

Servomotor pentru robinet deviator (art.2134); rotatie monodirectionala cu unghi de 180° dotat cu siguranta de protectie. Carcasa cu grad de protectie IP44

Cod	Tensiune	Timp manevra	Pret €	Ambalare
213 0025	230 Vac	60 sec		1/8
213 0031	24 Vac	60 sec		1/8



2137

Robinet cu sfera, motorizat cu 3 cai cu by-pass, cu 3 intrari

i Disponibil si cu alimentare 24 Vac

Cod	Dimensiune	Aliment.	Pret €	Ambalare
213 0021	3/4"	230 Vac		1/4
213 0015	1"	230 Vac		1/4



2136

Robinet cu sfera, motorizat cu 3 cai cu by-pass, cu 4 intrari, distanta variabila intre axe (50-63 mm pentru robinet de 3/4" - 55-63 mm pentru robinet de 1")

i Disponibil si cu alimentare 24 Vac

Cod	Dimensiune	Aliment.	Pret €	Ambalare
213 0013	3/4"	230 Vac		1/4
213 0028	1"	230 Vac		1/4





9536

Servomotor pentru robinet de zona cu by-pass (art. 2136-2137); rotatie bidirectionala cu unghi de 90° dotat cu siguranta de protectie. Carcasa cu grad de protectie IP44

Cod	Tensiune	Timp manevra	Pret €	Ambalare
213 0030	230 Vac	30 sec		1/8
213 0037	24 Vac	30 sec		1/8

2138 - 2133

CARACTERISTICI TEHNICE

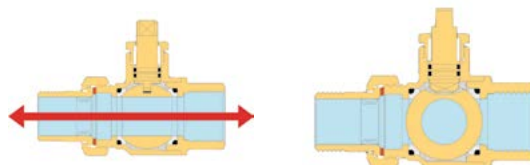

- Alimentare 230 Vac sau 24 Vac
- Contact releu 6A 250 Vac
- Grad de protectie IP 44
- Cuplu maxim de rotatie 10 Nm
- Timp rotatie 30 sec.
- Siguranta 5x20 F350 mA

2134

CARACTERISTICI TEHNICE

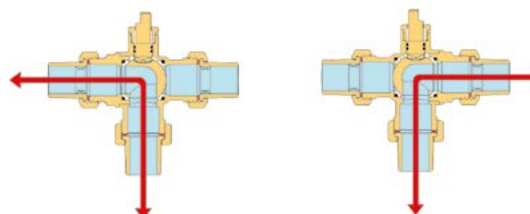

- Alimentare 230 Vac sau 24 Vac
- Contact releu 6A 250 Vac
- Grad de protectie IP 44
- Cuplu maxim de rotatie 10 Nm
- Timp rotatie 60 sec.
- Siguranta 5x20 F350 mA.

2137

CARACTERISTICI TEHNICE

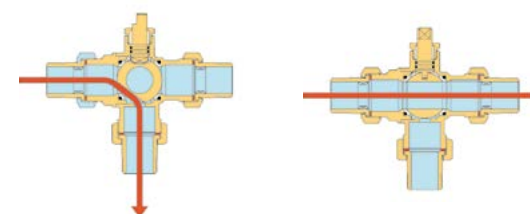

- Alimentare 230 Vac sau 24 Vac
- Contact releu 6A 250 Vac
- Grad de protectie IP 44
- Cuplu maxim de rotatie 10 Nm
- Timp rotatie 30 sec.
- Siguranta 5x20 F350 mA

2136

CARACTERISTICI TEHNICE

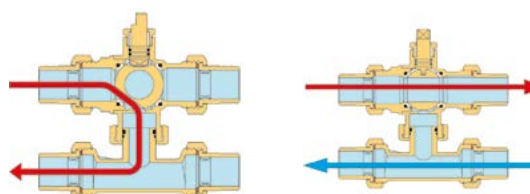

- Alimentare 230 Vac sau 24 Vac
- Contact releu 6A 250 Vac
- Grad de protectie IP 44
- Cuplu maxim de rotatie 10 Nm
- Timp rotatie 30 sec.
- Siguranta 5x20 F350 mA



2959
Robinet special sublavoar cu filtru si rozeta decorativa

Cod	Dimensiune	Pret €	Ambalare
295 0049	1/2" x 3/8"		15/60
295 0055	1/2" x 1/2"		15/60



2956
Robinet special sublavoar cu filtru si rozeta decorativa

Cod	Dimensiune	Pret €	Ambalare
295 0004	1/2" x 3/8"		15/60
295 0012	1/2" x 1/2"		15/60



2955
Robinet special sublavoar orientabil cu filtru si rozeta decorativa

Cod	Dimensiune	Pret €	Ambalare
295 0224	1/2" x 10		15/60



2948
Robinet special sublavoar orientabil 1/2"x(1/2", 3/8", Ø10) si rozeta decorativa

Cod	Dimensiune	Pret €	Ambalare
295 0007	1/2" x 10		15/60

2959 - 2956
2955 - 2948

DIMENSIUNI

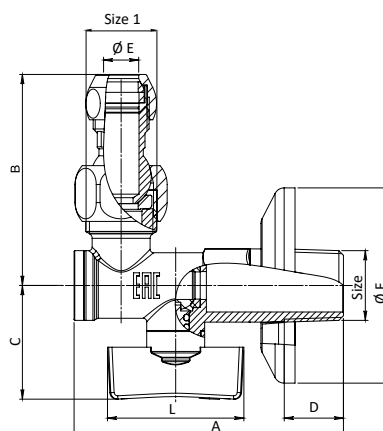

Cod	Size	Size 1 Ø	A	B	C	D	Ø E	Ø F	L
295 0049	R 1/2"	G 3/8"	72	22	32,5	16	-	56	31,5
295 0055	R 1/2"	G 1/2"	72	22	32,5	16	-	56	31,5
295 0004	R 1/2"	G 3/8"	79	22	32,5	17,5	-	56	40
295 0012	R 1/2"	G 1/2"	79	22	32,5	17,5	-	56	40
295 0224	R 1/2"	G 1/2"	70	60	32	15	10	56	31,5
295 0007	R 1/2"	G 1/2"	79	60	32,5	17,5	10	56	40





3906C

Robinet sublavoar cu obertein si rozeta decorativa

Cod	Dimensiune	Pret €	Ambalare
295 0132	1/2" x 3/8"		1/60
295 0130	1/2" x 1/2"		1/60



3907C

Robinet sublavoar cu obertein si rozeta decorativa

Cod	Dimensiune	Pret €	Ambalare
295 0133	1/2" x 10		1/60



3901C

Robinet sublavoar cu obertein si rozeta decorativa

Cod	Dimensiune	Pret €	Ambalare
295 0013	1/2" x 3/8"		10/50
295 0008	1/2" x 1/2"		10/50



3900C

Robinet sublavoar cu obertein si rozeta decorativa

Cod	Dimensiune	Pret €	Ambalare
295 0016	1/2" x 10		10/50



3903C

Robinet sublavoar inclinat M cu filtru si rozeta decorativa

Cod	Dimensiune	Pret €	Ambalare
295 0076	1/2" x 3/8"		1/50



3902C

Robinet sublavoar inclinat M/ tub de cupru cu filtru, orientabil si rozeta decorativa

Cod	Dimensiune	Pret €	Ambalare
295 0038	1/2" x 10		1/50

3901C - 3906C DIMENSIUNI

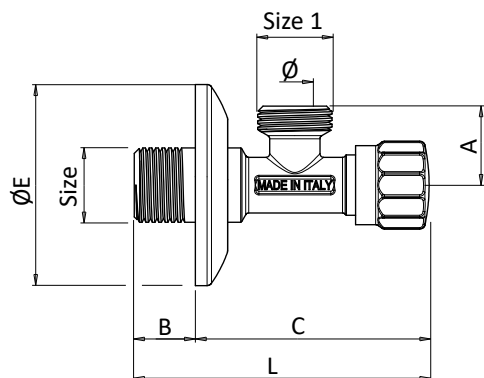

Cod	Size	Size 1	Ø (DN)	A	B	C	Ø E	L
295 0013	1/2"	3/8"	10	23	14	76	56	90
295 0008	1/2"	1/2"	10	23	14	76	56	90
295 0132	1/2"	3/8"	10	22	14	68	56	82
295 0130	1/2"	1/2"	10	22	14	68	56	82



3908C

Robinet pentru masina de spalat cu obtein si rozeta decorativa

Cod	Dimensiune	Pret €	Ambalare
295 0165	1/2" x 3/4"		1/75



3997

Robinet sublavoar cu obtein

Cod	Dimensiune	Pret €	Ambalare
295 0042	1/2" x 1/2"		20/60



2950

Robinet WASH pentru masina de spalat M/M ISO228 cu maneta cromata

Cod	Dimensiune	Pret €	Ambalare
295 0018	1/2" x 1/2"		25/100
295 0011	1/2" x 3/4"		10/50



2953

Robinet WASH pentru masina de spalat M/M ISO 228 cu rozeta decorativa

Cod	Dimensiune	Pret €	Ambalare
295 0010	1/2" x 1/2"		15/60
295 0003	1/2" x 3/4"		10/50



2954

Robinet de colt M/M ISO228 cu maneta cromata si rozeta decorativa

Cod	Dimensiune	Pret €	Ambalare
295 0002	1/2" x 1/2"		1/50
295 0019	1/2" x 3/4"		1/50

2954

DIMENSIUNI

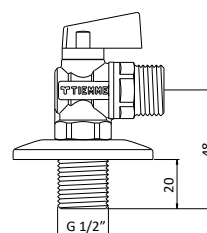

3916C

Robinet coltar mixt cu supapa sens incorporata, combina un robinet ventil coltar si un robinet pentru masina de spalat

Cod	Dimensiune	Pret €	Ambalare
295 0197	1/2" x 3/4" x 3/8"		1/12

3916C

FUNCTIONARE

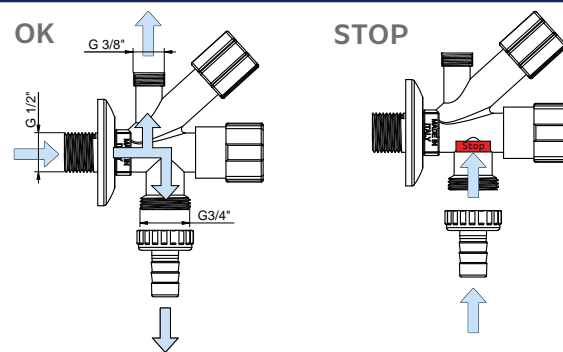



3909C
Robinet sublavoar dublu si rozeta decorativa. Ventil ceramic

Cod	Dimensiune	Pret €	Ambalare
295 0178	1/2" x (1/2" - 3/8")		1/20
295 0196	1/2" x (1/2" - 1/2")		1/20

NOUJATI



3925C
Robinet sublavoar si rozeta decorativa. Ventil ceramic

Cod	Dimensiune	Pret €	Ambalare
295 0241	1/2"		1/25



3910
Racord cromat drept, M pentru legaturi hidro-sanitare

Cod	Dimensiune	Pret €	Ambalare
295 0059	3/8" x 10		10/300
295 0033	1/2" x 10		10/250



3912
Racord drept F pentru legaturi hidro-sanitare

Cod	Dimensiune	Pret €	Ambalare
295 0062	3/8" x 10		10/350
295 0050	1/2" x 10		10/300



3911
Racord drept dublu pentru legaturi hidro-sanitare

Cod	Dimensiune	Pret €	Ambalare
295 0039	10 x 10		10/300



3905C
Cot dus cu rozeta decorativa M/M

Cod	Dimensiune	Pret €	Ambalare
295 0027	1/2"		20/60



2966
Cot sublavoar 90°

Cod	Dimensiune	Pret €	Ambalare
295 0066	1/2" x 3/8"		10/40



2960

Robinet pentru montaj ingropat, fara maneta, model INWALL

Cod	Dimensiune	Pret €	Ambalare
295 0005	1/2"		15/60
295 0020	3/4"		10/40

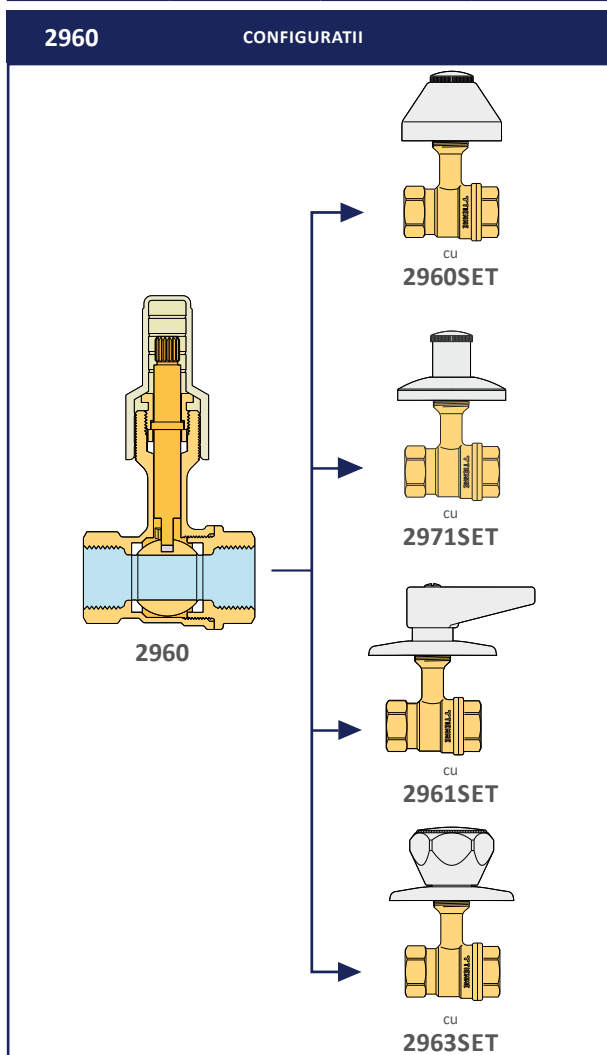

2960SET

Set format din cap si rozeta pentru robinetii de incastat art. 2960, 1690, 1690U, 1696, 1740, 1740U si 1746

Cod	Dimensiune	Pret €	Ambalare
295 0006	-		1/25



2971SET

Set format din cap si rozeta pentru robinetii de incastat Art. 2960, 1690, 1690U, 1696, 1740, 1740U si 1746

Cod	Dimensiune	Pret €	Ambalare
295 0167	-		1/25



2961SET

Set maneta si rozeta decorativa pentru robinetii de incastat art. 2960, 1690, 1690U, 1696, 1740, 1740U si 1746

Cod	Dimensiune	Pret €	Ambalare
295 0009	-		1/25



2963SET

Set maneta si rozeta decorativa pentru robinetii de incastat art. 2960, 1690, 1690U, 1696, 1740, 1740U si 1746.

Cod	Dimensiune	Pret €	Ambalare
295 0014	-		1/25



2960PR

Set de prelungire pentru robinetii de incastat Art. 2960, 1690, 1690U, 1696, 1740, 1740U si 1746

Cod	Dimensiune	Pret €	Ambalare
295 0015	-		1/100





2964

Robinet de incastat PN10 F/F cu rozeta reglabila si maneta

Cod	Dimensiune	Pret €	Ambalare
295 0079	1/2"		5/20
295 0142	3/4"		5/20



2964Z

Robinet de incastat PN10 F/F cu rozeta reglabila si maneta metalica

Cod	Dimensiune	Pret €	Ambalare
295 0134	1/2"		5/20
295 0135	3/4"		5/20
295 0136	1"		5/20

La cerere



2965

Robinet cu obertein de incastat

Cod	Dimensiune	Pret €	Ambalare
295 0026	1/2"		10/30



2965PROL

Set de prelungire pentru robineti art. 2965

Cod	Dimensiune	Pret €	Ambalare
295 0067	-		1/100



2961

INWALL robinet cu sfera pentru instalatii ingropate din cupru prin lipire

Cod	Dimensiune	Pret €	Ambalare
295 0077	15		10/40
295 0074	18		5/20
295 0078	22		5/20

Până la terminarea stocului



2967

Robinet PN 10 F/F cu obertein

Cod	Dimensiune	Pret €	Ambalare
295 0080	1/2"		20/80
295 0081	3/4"		15/60



2970

Robinet pentru hidrant de gradina

Cod	Dimensiune	Pret €	Ambalare
295 0021	1/2"		12/36
295 0028	3/4"		10/30
295 0043	1"		5/15



3994

Robinet cu sertar PN16

Cod	Dimensiune	Pret €	Ambalare
295 0061	1/2"		20/80
295 0041	3/4"		10/40
295 0048	1"		10/40
295 0047	1" 1/4		5/20
295 0095	1" 1/2		3/12
295 0045	2"		2/6
295 0069	2" 1/2		1/5
295 0060	3"		1/5
295 0064	4"		1/2



3996L
Robinet cu 3 cai

Cod	Dimensiune	Pret €	Ambalare
295 0068	3/8"		6/30
295 0025	1/2"		5/25
295 0031	3/4"		4/20
295 0030	1"		4/16
295 0051	1"1/4		1/5
295 0057	1"1/2		1/5
295 0052	2"		1/5



3996T
Robinet cu 3 cai si cu sfera T

Cod	Dimensiune	Pret €	Ambalare
295 0063	3/8"		6/30
295 0058	1/2"		5/25
295 0053	3/4"		4/20
295 0056	1"		4/16
295 0065	1"1/4		1/5
295 0071	1"1/2		1/5
295 0072	2"		1/5



2990G
Robinet cu sfera pentru golire



Cod	Dimensiune	Pret €	Ambalare
295 0024	3/8"		25/100
295 0001	1/2"		25/100
295 0040	1/2"		10/50

Versiune cu lant metalic



3992
Robinet flotor din alama stantata cu tija din plastic

Cod	Dimensiune	Pret €	Ambalare
295 0179	1/2"		1/55
295 0188	3/4"		1/55



3992OT
Robinet flotor din alama stantata cu tija din alama

Cod	Dimensiune	Pret €	Ambalare
295 0189	1/2"		1/55
295 0180	3/4"		1/55
295 0181	1"		1/27



3992PAL
Sfera din plastic pentru robineti cu flotor

Cod	Dimensiune	Pret €	Ambalare
295 0182	Ø 120		1/55
295 0184	Ø 150		1/27



1835C
Robinet flotor

Cod	Dimensiune	Pret €	Ambalare
075 0049	3/4"		1/50
075 0050	1"		1/50
075 0051	1"1/4		1/10
075 0052	1"1/2		1/10
075 0053	2"		1/5
075 0054	2"1/2		1/4
075 0055	3"		1/4
075 0056	4"		1/2



LISTA DE PRETURI

01_A ROBINETI CU SFERA PENTRU APLICATII SPECIALE



1836P

Sfera plutitor din polietilenă PEHD de înaltă densitate cu racord culisant și opritor cu șurub

Cod	∅	Pret €	Ambalare
075 0057	120		1/200
075 0058	150		1/100
075 0059	180		1/50
075 0060	220		1/30
075 0061	300		1/10



1837R

Sfera plutitor din cupru, cu racord culisant și opritor cu șurub

Cod	∅	Pret €	Ambalare
075 0062	120		1/1
075 0063	150		1/1
075 0064	180		1/1

01_A SUPAPE DE SENS



3500

Supapa de sens YACHT F/F ISO228 cu obturator in nylon



Cod	Dimensiune	Pret €	Ambalare
350 0003	1/2"		15/60
350 0004	3/4"		12/48
350 0001	1"		8/32
350 0006	1"1/4		6/24
350 0008	1"1/2		4/16
350 0007	2"		2/8
350 0022	2"1/2		1/6
350 0018	3"		1/4
350 0034	4"		1/2



3506

Supapa de sens EUROSTOP F/F ISO228 cu obturator metalic



Cod	Dimensiune	Pret €	Ambalare
350 0142	1/2"		15/60
350 0143	3/4"		10/40
350 0144	1"		6/24
350 0145	1"1/4		5/20
350 0146	1"1/2		2/8
350 0147	2"		2/8
350 0050	2"1/2		1/6
350 0051	3"		1/4
350 0058	4"		1/2



3600
Supapa de sens YACHT F ISO228
cu filtru inox



Cod	Dimensiune	Pret €	Ambalare
350 0053	1/2"		8/80
350 0037	3/4"		8/48
350 0012	1"		7/63
350 0027	1"1/4		6/24
350 0039	1"1/2		3/15
350 0040	2"		2/18
350 0057	2"1/2		1/6
350 0059	3"		1/3
350 0065	4"		1/2



3606
Supapa de sens EUROSTOP F
ISO228 cu filtru inox



Cod	Dimensiune	Pret €	Ambalare
350 0348	1/2"		16/64
350 0349	3/4"		12/48
350 0350	1"		9/36
350 0351	1"1/4		4/16
350 0352	1"1/2		3/12
350 0353	2"		2/8
350 0354	2"1/2		1/5
350 0355	3"		1/3
350 0356	4"		1/2



3510
Filtru inox pentru supapa de
sens YACHT

Cod	Dimensiune	Pret €	Ambalare
350 0054	1/2"		1/100
350 0044	3/4"		1/50
350 0029	1"		1/25
350 0038	1"1/4		1/20
350 0056	1"1/2		1/10
350 0052	2"		1/5
350 0064	2"1/2		1/4
350 0063	3"		1/3
350 0046	4"		1/2



3681
Supapa de sens controlabila,
anti-poluare model EA

Controlabil (tip EA)

Cod	Dimensiune	Pret €	Ambalare
350 0346	3/4"		10/50
350 0347	1"		10/50



3660
Supapa de sens cu clapet FULL
F/F ISO228 cu obturator din
alama CU GARNITURA



Cod	Dimensiune	Pret €	Ambalare
350 0015	1/2"		25/75
350 0016	3/4"		15/45
350 0009	1"		10/30
350 0017	1"1/4		5/20
350 0020	1"1/2		5/15
350 0011	2"		2/12
350 0028	2"1/2		1/5
350 0026	3"		1/3
350 0042	4"		1/2



3665
Supapa de sens cu clapet FULL
F/F ISO228 cu obturator din
alama FARA GARNITURA



Cod	Dimensiune	Pret €	Ambalare
350 0135	1/2"		25/75
350 0136	3/4"		15/45
350 0137	1"		10/30
350 0138	1"1/4		5/25
350 0139	1"1/2		5/15
350 0140	2"		2/12
350 0343	2"1/2		1/5
350 0344	3"		1/3
350 0345	4"		1/2



LISTA DE PRETURI

01_A SUPAPE DE SENS

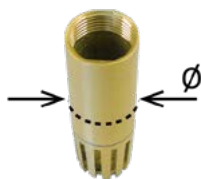

3651
Sorb alama tubular F ISO228

Cod	Dimensiune	Ø	Pret €	Ambalare
350 0047	3/4"	30		5/25
350 0024	1"	37		4/20
350 0043	1"1/4	46		3/15
350 0049	1"1/2	54		4/12
350 0055	2"	65		2/6
350 0062	2"1/2	82		1/5
350 0061	3"	99		1/3
350 0060	4"	116		1/1



3650
Sorb complet alama GLOB F ISO228

Cod	Dimensiune	Pret €	Ambalare
350 0175	1/2"		12/48
350 0033	3/4"		12/36
350 0010	1"		10/30
350 0014	1"1/4		6/18
350 0036	1"1/2		5/15
350 0032	2"		3/9
350 0048	2"1/2		1/6
350 0041	3"		1/3
350 0045	4"		1/5

01_A FILTRE Y



3670
Filtru Y de impuritati

CARACTERISTICI TEHNICE:

- Grad de filtrare: de la 350 µm la 600 µm in functie de diametru
- Corpul: alama CW 617N
- Presiune maxima de exercitiu: 20 bar pana la 2"; 16 bar celelalte
- Temperatura maxima de exercitiu: 100°C
- Filete: F/F ISO 228

Cod	Dimensiune	Pret €	Ambalare
367 0003	1/2"		20/80
367 0001	3/4"		18/54
367 0002	1"		10/30
367 0005	1"1/4		4/16
367 0009	1"1/2		3/12
367 0004	2"		2/8
367 0011	2"1/2		1/8
367 0014	3"		1/5
367 0015	4"		1/1

Orificiu pentru sigiliu



2094

Set de prelungire pentru robineti montati pe conducte izolate

Cod	URAGANO	SCIROCCO	MISTRAL	TORNADO	BURAN	Art. 2121	Pret €	Ambalare
209 0001	1/4" - 3/8" - 1/2"	1/4" - 3/8" - 1/2" - 3/4"	1/2" - 3/4"	1/2" - 3/4"	1/2" - 3/4"	1/2" - 3/4"		40/120
209 0003	3/4"-1"	1"	1" - 1"1/4	1" - 1"1/4	1" - 1"1/4	1" - 1"1/4		30/90
209 0002	1"1/4 - 1"1/2 - 2"	1"1/4 - 1"1/2 - 2"	1"1/2 - 2"	1"1/2 - 2"	1"1/2 - 2"	1"1/2		20/60
209 0006	2"1/2 - 3" - 4"	2"1/2 - 3" - 4"	-	-	2"1/2 - 3" - 4"	-		5/15



2595

Portfurtun stut pentru robinet serie EOLO

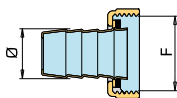

Cod	F	EOLO	Ø	Pret €	Ambalare
250 0010	3/4"	3/8" - 1/2"	14		50/300
250 0014	1"	3/4"	20		25/150
250 0016	1"1/4	1"	25		10/80



2596

Conector furtun prindere rapida cu garnitura pentru robineti EOLO

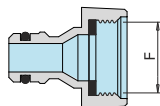

Cod	F	EOLO	Pret €	Ambalare
250 0109	3/4"	1/2"		50/300
250 0110	1"	3/4"		25/150



2962

Rozeta metalica

Cod	Dimensiune	Pret €	Ambalare
209 0005	1/2"		30/360



01_B ROBINETI CU SFERA "TORNADO" PENTRU GAZ

MOP 5



2370G07

Robinet F/F ISO 7/EN10226 cu maneta tip fluture de culoare galbena

Cod	Dimensiune	Pret €	Ambalare
239 0008	1/2"		25/100
239 0009	3/4"		15/60
239 0010	1"		8/32
239 0016	1"1/4		5/20



2371G07

Robinet M/F ISO 7/EN10226 cu maneta tip fluture de culoare galbena

Cod	Dimensiune	Pret €	Ambalare
239 0003	1/2"		25/100
239 0011	3/4"		15/60
239 0012	1"		8/32
239 0020	1"1/4		5/20



2380G07

Robinet F/F ISO 7/EN 10226 cu maneta de otel de culoare galbena

Cod	Dimensiune	Pret €	Ambalare
239 0001	1/2"		20/80
239 0006	3/4"		14/56
239 0007	1"		10/40
239 0004	1"1/4		6/24
239 0002	1"1/2		3/12
239 0005	2"		2/8



2381G07

Robinet M/F ISO 7/EN 10226 cu maneta de otel de culoare galbena

Cod	Dimensiune	Pret €	Ambalare
239 0013	1/2"		20/80
239 0014	3/4"		10/40
239 0015	1"		8/32
239 0018	1"1/4		4/16
239 0017	1"1/2		3/12
239 0019	2"		2/8

DIMENSIUNI

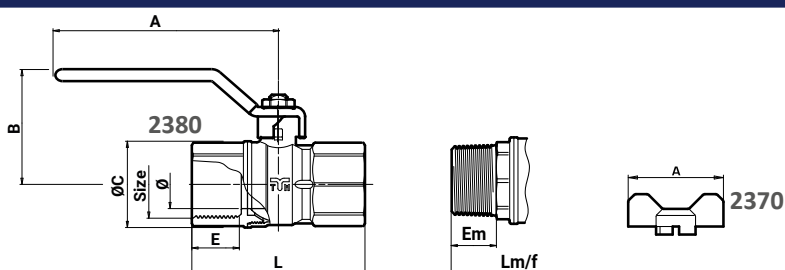

Dimensiune	Mod.	1/2"	3/4"	1"	1" 1/4	1" 1/2	2"
Ø (DN)	toate	14,0	18,0	23,5	30,0	37,5	47,0
A	2370/2371	50,0	50,0	65,0	65,0	-	-
	2380/2381	85,0	85,0	113,0	113,0	141,0	141,0
B	toate	48,0	52,5	59,5	64,5	76,0	89,0
Ø C	toate	27,5	33,5	42,0	53,0	64,0	79,0
E	ISO7	17,0	18,0	21,5	24,0	24,0	28,5
Em	ISO7	16,5	18,0	21,0	23,5	23,5	28,0
L	ISO7	58,0	66,5	78,0	93,0	101,0	121,0
Lm/f	ISO7	63,5	72,0	83,0	99,1	108,0	129,0
PN		30	30	30	25	25	25

Toate dimensiunile cu exceptia PN-ului sunt exprimate in mm



2200G

Robinet F/F ISO 7/EN 10226 cu maneta de oțel de culoare galbena



Cod	Dimensiune	Pret €	Ambalare
221 0024	1/4"		25/100
221 0018	3/8"		25/100
221 0001	1/2"		20/80
221 0003	3/4"		10/40
221 0007	1"		8/32
221 0010	1"1/4		4/16
221 0011	1"1/2		3/12
221 0005	2"		2/8
221 0013	2"1/2		1/4
221 0014	3"		1/3
221 0019	4"		1/1

MOP 5



2201G

Robinet M/F ISO 7/EN 10226 cu maneta de oțel de culoare galbena



Cod	Dimensiune	Pret €	Ambalare
221 0012	1/2"		20/80
221 0016	3/4"		10/40
221 0017	1"		8/32
221 0022	1"1/4		4/16
221 0023	1"1/2		3/12
221 0025	2"		2/8

MOP 5



2220G

Robinet F/F ISO 7/EN 10226 cu maneta tip fluture, sigilabila, de culoare galbena



Cod	Dimensiune	Pret €	Ambalare
221 0031	1/4"		25/100
221 0020	3/8"		25/100
221 0002	1/2"		20/80
221 0006	3/4"		15/60
221 0009	1"		8/32

MOP 5



2221G

Robinet M/F ISO 7/EN 10226 cu maneta tip fluture, sigilabila, de culoare galbena



Cod	Dimensiune	Pret €	Ambalare
221 0026	3/8"		25/100
221 0004	1/2"		25/100
221 0008	3/4"		15/60
221 0015	1"		8/32

MOP 5



01_B ROBINETI CU SFERA "URAGANO" PENTRU GAZ - EN 331

EN 331



2240G

Robinet F/F ISO 7/EN 10226
versiune sigilabila din alama
si capac din plastic de culoare
galbena



2241G

Robinet M/F ISO 7/EN 10226
versiune sigilabila din alama
si capac din plastic de culoare
galbena



Cod	Dimensiune	Pret €	Ambalare
221 0033	1/2"		25/100
221 0029	3/4"		15/60
221 0021	1"		8/32
221 0030	1"1/4		4/16
221 0027	1"1/2		3/12
221 0028	2"		2/8

MOP 5

Cod	Dimensiune	Pret €	Ambalare
221 0035	1/2"		25/100
221 0032	3/4"		15/60
221 0036	1"		8/32
221 0037	1"1/4		4/16
221 0038	1"1/2		3/12
221 0034	2"		2/8

MOP 5

DIMENSIUNI

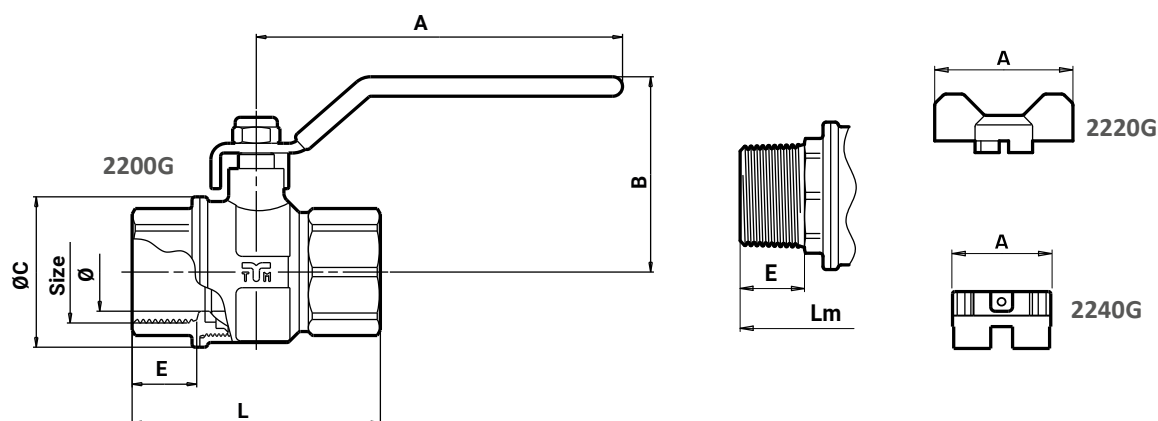

Dimensiune	1/4"	3/8"	1/2"	3/4"	1"	1"1/4	1"1/2	2"	2"1/2	3"	4"
Ø (DN)	10	10	15	20	25	32	40	50	65	80	100
A 2200G	85	85	85	113	113	141	141	141	240	240	240
A 2220G	50	50	50	65	65	-	-	-	-	-	-
A 2240G	-	-	22	27	27	32	32	32	-	-	-
B	39	39	44.5	53.5	57.5	73.5	79.5	92	125.5	136	150.5
ØC	23	23	32.5	39	48	59	71	86	114	131	164
E	10	12	16.5	18	20.6	23.5	23.5	28	34	37	43
L	42	47	59.5	67.5	79	96	105	126	156	177	214
Em	-	11.5	16.5	18	21	23.5	23.5	28	-	-	-
Lm	-	57	67.5	75.5	87	106	114	136.5	-	-	-
PN	50	50	64	40	40	30	30	30	20	20	20

Toate dimensiunile cu exceptia PN-ului sunt exprimate in mm



PCONT01

Robinet drept M/F (M ISO 228/F ISO 7) cu sfera, trecere totala si priză pentru citirea presiunii

Cod	Dimensiune	Pret €	Ambalare
221 0050	3/4" F x 1" 1/4 M		10/40
221 0066	1" F x 1" 1/4 M		6/24



PCONT01SER

Robinet drept M/F (M ISO 228/F ISO 7) cu sfera, trecere totala si priză pentru citirea presiunii, cu inchidere dubla

Cod	Dimensiune	Pret €	Ambalare
221 0052	3/4" F x 1" 1/4 M		5/20
221 0068	1" F x 1" 1/4 M		5/20



PCONT02

Robinet drept F/F cu sfera, trecere totala si priză pentru citirea presiunii

Cod	Dimensiune	Pret €	Ambalare
221 0054	3/4" F x 3/4" F		10/40
221 0070	1" F x 1" F		5/20



PCONT02SER

Robinet drept F/F ISO 7 cu sfera, trecere totala priză pentru citirea presiunii si inchidere dubla

Cod	Dimensiune	Pret €	Ambalare
221 0056	3/4" F x 3/4" F		5/20
221 0072	1" F x 1" F		5/20



PCONT03

Robinet drept cu sfera, trecere totala si priză pentru citirea presiunii, cu filet masculin (feminin) pe curba rotativa la 360° si feminin pe piulita

Se infileteaza direct pe contor

Cod	Dimensiune	Pret €	Ambalare
221 0058	1" M (3/4" F) x 1" 1/4 F		5/20



PCONT03SER

Robinet drept cu sfera, trecere totala si priză pentru citirea presiunii, cu filet masculin (feminin) ISO 7 pe cotul rotativ la 360° si feminin ISO 228 pe piulita, cu inchidere dubla

Se infileteaza direct pe contor

Cod	Dimensiune	Pret €	Ambalare
221 0060	1" M (3/4" F) x 1" 1/4 F		5/20



PCONT04

Robinet drept F/F cu trecere totala si piulita

Se infileteaza direct pe contor

Cod	Dimensiune	Pret €	Ambalare
221 0062	1" F x 1" 1/4 F		5/20



PCONT04SER

Robinet drept F/F (F ISO 7/F ISO 228) cu trecere totala, piulita, inchidere dubla

Se infileteaza direct pe contor

Cod	Dimensiune	Pret €	Ambalare
221 0064	1" F x 1" 1/4 F		5/20



PCONT05

Robinet M/F (M ISO 228/F ISO 7) de colt cu trecere totala si priză pentru citirea presiunii

Cod	Dimensiune	Pret €	Ambalare
221 0074	3/4" F x 1" 1/4 M		10/40
221 0078	1" F x 1" 1/4 M		5/20



PCONT05SER

Robinet M/F (M ISO 228/F ISO 7) de colt cu trecere totala, priză pentru citirea presiunii, inchidere dubla

Cod	Dimensiune	Pret €	Ambalare
221 0076	3/4" F x 1" 1/4 M		5/20
221 0080	1" F x 1" 1/4 M		5/20



PCONT07

Robinet F/F ISO 7 de colt cu trecere totala si priză pentru citirea presiunii

Cod	Dimensiune	Pret €	Ambalare
221 0083	3/4" F x 3/4" F		10/40
221 0084	1" F x 1" F		5/20



PCONT07SER

Robinet F/F ISO 7 de colt cu trecere totala, priză pentru citirea presiunii, inchidere dubla

Cod	Dimensiune	Pret €	Ambalare
221 0085	3/4" F x 3/4" F		5/20
221 0086	1" F x 1" F		5/20



PCONT06

Set niplu, piulita si garnitura cu filet masculin

Cod	Dimensiune	Pret €	Ambalare
221 0082	1" M x 1" 1/4 F		1/50



PCONT08

Robinet de siguranță cu priză pentru citirea presiunii

Cod	Dimensiune	Pret €	Ambalare
221 0088	1/4"		1/50

TUTORIAL VIDEO



Robineti de instalat dupa montarea contorului de gaz



2225G

Robinet de colt pentru gaz F / F ISO 7/EN 10226 cu maneta tip fluture de culoare galbena

Cod	Dimensiune	Pret €	Ambalare
222 0061	1/2"		15/60



2223G

Robinet de colt ISO 7/EN 10226 cu maneta tip fluture de culoare galbena

Cod	Dimensiune	Pret €	Ambalare
222 0001	1/2"		20/80
222 0016	3/4"		10/40



2262G

Robinet de colt F ISO 7/EN 10226 cu maneta tip fluture de culoare galbena cu piulita

Cod	Dimensiune	Pret €	Ambalare
222 0012	1/2"		20/80



2224G

Robinet de colt M ISO 7/EN 10226 cu maneta tip fluture de culoare galbena cu piulita

Cod	Dimensiune	Pret €	Ambalare
222 0002	1/2" M x 1/2" F		20/80
222 0005	1/2" M x 3/4" F		20/80
222 0010	3/4" M x 3/4" F		10/40



2263G

Robinet drept F ISO 228 cu maneta tip fluture, sigilabila, de culoare galbena, cu piulita

Cod	Dimensiune	Pret €	Ambalare
222 0015	1/2" x 1/2"		20/80
222 0008	3/4" x 3/4"		20/80
222 0017	1" x 1"		10/40
222 0040	1/2" x 3/4"		20/80
222 0041	3/4" x 1"		10/40

Versiunea nichelata



2266G

Robinet drept pentru gaz M cu piulita si maneta tip fluture de culoare galbena

Cod	Dimensiune	Pret €	Ambalare
222 0058	1/2" M ISO7 - 1/2" F		20/80
222 0059	1/2" M ISO7 - 3/4" F		20/80
222 0060	3/4" M - 3/4" F		20/80



Seria 1600

Racorduri de compresie pentru tub multistrat "AL-COBRAPEX"



58

Robineti cu capete de compresie pentru tub multistrat "AL-COBRAPEX"



64

 GHID DE COMPATIBILITATE

Seria	Tub potrivit	Domeniu de aplicare	Caracteristici tehnice
1600	Multistrat "AL-COBRAPEX"	• Apa	Tmax: + 95 °C Pmax: 10 bar

Pentru detalii suplimentare consultati fisa tehnica



1600
Racord drept M

Cod	Dimensiune	Pret €	Ambalare
160 0046	16 x 3/8"		10/100
160 0001	16 x 1/2"		10/100
160 0031	16 x 3/4"		5/100
160 0007	20 x 1/2"		5/100
160 0005	20 x 3/4"		5/100
160 0187	20 x 1"		5/50
160 0075	25 x 3/4"		5/100
160 0098	25 x 1"		5/100
160 0010	26 x 3/4"		5/50
160 0015	26 x 1"		5/50
160 0020	32 x 1"		5/50
340 0028	40 x 1"		2/20
340 0004	40 x 1" 1/4		2/20
340 0186	40 x 1" 1/2		2/20
340 0009	50 x 1" 1/2		2/10
340 0007	63 x 2"		1/10
340 0079	75 x 2"		1/10
340 0036	75 x 2" 1/2		1/10
340 0078	90 x 2" 1/2		1/6
340 0038	90 x 3"		1/6

De utilizat obligatoriu cu art. 1476

Varianta galbena la cerere

Noutati



1600OR
Racord drept M cu O-ring,
pentru colectoare bara

Cod	Dimensiune	Pret €	Ambalare
160 0022	16 x 1/2"		10/100
160 0072	20 x 1/2"		5/100



1602
Racord drept F

Cod	Dimensiune	Pret €	Ambalare
160 0069	16 x 3/8"		10/100
160 0004	16 x 1/2"		10/100
160 0035	16 x 3/4"		5/100
160 0016	20 x 1/2"		5/100
160 0011	20 x 3/4"		5/100
160 0188	20 x 1"		5/100
160 0092	25 x 3/4"		5/100
160 0112	25 x 1"		5/50
160 0021	26 x 3/4"		5/100
160 0029	26 x 1"		5/100
160 0039	32 x 1"		5/50
340 0013	40 x 1" 1/4		2/20
340 0187	40 x 1" 1/2		2/20
340 0034	50 x 1" 1/2		2/10
340 0189	50 x 2"		2/10
340 0026	63 x 2"		1/10
340 0054	75 x 2" 1/2		1/10
340 0061	90 x 3"		1/6

De utilizat obligatoriu cu art. 1476

Varianta galbena la cerere

Noutati



1614BP
Racord drept cu piulita si
GARNITURA PLATA

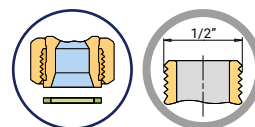

Cod	Dimensiune	Pret €	Ambalare
160 0167	16 x 3/8"		5/100
160 0156	16 x 1/2"		5/100
160 0168	16 x 3/4"		5/100
160 0169	20 x 1/2"		5/100
160 0157	20 x 3/4"		5/100
160 0435	20 x 1"		5/50
160 0170	26 x 3/4"		5/50
160 0171	26 x 1"		5/50
160 0166	32 x 1"		5/25
160 0172	32 x 1" 1/4		2/20
160 0173	32 x 1" 1/2		2/20

**1601**

Racord drept dublu

Cod	Dimensiune	Pret €	Ambalare
160 0012	16 x 16		10/100
160 0053	20 x 16		5/100
160 0024	20 x 20		5/100
160 0104	25 x 25		5/50
160 0160	26 x 16		5/50
160 0081	26 x 20		5/50
160 0045	26 x 26		5/50
160 0161	32 x 16		5/25
160 0159	32 x 20		5/25
160 0148	32 x 26		5/25
160 0056	32 x 32		5/25
340 0029	40 x 40		2/10
340 0025	50 x 50		2/8
340 0015	63 x 63		1/8
340 0039	75 x 75		1/6
340 0042	90 x 90		1/6

De utilizat obligatoriu cu art. 1476

Varianta galbena la cerere

Până la terminarea stocului

**1601KB**

Racord drept dublu de compresie pentru tub multistrat/cupru

 Varianta galbena la cerere

Cod	Dimensiune	Pret €	Ambalare
160 0145	16 x 2 - Ø15		10/100

**1604**

Cot M

Cod	Dimensiune	Pret €	Ambalare
160 0013	16 x 1/2"		10/100
160 0066	16 x 3/4"		5/100
160 0042	20 x 1/2"		10/100
160 0028	20 x 3/4"		5/100
160 0189	20 x 1"		5/50
160 0116	25 x 3/4"		5/50
160 0119	25 x 1"		5/50
160 0050	26 x 3/4"		5/50
160 0051	26 x 1"		5/50
160 0067	32 x 1"		5/25
340 0044	40 x 1" 1/4		2/10
340 0053	50 x 1" 1/2		2/8
340 0062	63 x 2"		1/4
340 0076	75 x 2" 1/2		1/5
340 0128	90 x 3"		1/4

De utilizat obligatoriu cu art. 1476

Varianta galbena la cerere

1605
Cot F

Cod	Dimensiune	Pret €	Ambalare
160 0006	16 x 1/2"		10/100
160 0061	16 x 3/4"		5/100
160 0126	16 (2,25) x 1/2"		10/100
160 0026	20 x 1/2"		5/100
160 0023	20 x 3/4"		5/50
160 0133	20 (2,5) x 3/4"		5/50
160 0190	20 x 1"		5/50
160 0093	25 x 3/4"		5/50
160 0117	25 x 1"		5/50
160 0034	26 x 3/4"		5/50
160 0052	26 x 1"		5/50
160 0060	32 x 1"		5/25
340 0035	40 x 1" 1/4		2/10
340 0051	50 x 1" 1/2		2/8
340 0048	63 x 2"		1/5
340 0074	75 x 2" 1/2		1/5
340 0129	90 x 3"		1/3

De utilizat obligatoriu cu art. 1476

Varianta galbena la cerere

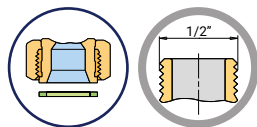
1615BP
Racord cot cu piulita si
GARNITURA PLATA

Cod	Dimensiune	Pret €	Ambalare
160 0162	16 X 3/8"		5/100
160 0151	16 x 1/2"		5/100
160 0152	16 x 3/4"		5/100
160 0153	20 x 1/2"		5/100
160 0154	20 x 3/4"		5/100
160 0434	20 x 1"		5/50
160 0155	26 x 3/4"		5/50
160 0163	26 x 1"		5/50
160 0164	32 x 1"		5/25

1606
Cot F cu flansa

Cod	Dimensiune	Pret €	Ambalare
160 0003	16 x 1/2"		10/100
160 0096	16 x 3/4"		5/50
160 0027	20 x 1/2"		5/50
160 0055	20 x 3/4"		5/50

Varianta galbena la cerere

1616
Consola cu racorduri finale

i Interaxe variabile:
100 - 110 - 150 mm

Cod	Dimensiune	Pret €	Ambalare
160 0346	16 x 2,0 - 1/2"		1/20
160 0347	20 x 2,0 - 1/2"		1/20

1616M
Consola cu racorduri finale

i Interaxe variabile:
100 - 110 - 150 mm

Cod	Dimensiune	Pret €	Ambalare
160 0344	16 x 2,0 - 3/4"		1/20
160 0345	20 x 2,0 - 3/4"		1/20

1612C
Cot masculin cu flanșă (cromată
lucioasă)

i Furnizat cu holsurub si diblu

Cod	Dimensiune	Pret €	Ambalare
045 0605	16 x 2,0 - 3/4"		1/100
045 0627	20 x 2,0 - 3/4"		1/100



LISTA DE PREȚURI

**1613C**

Cot feminin cu flanșă (cromată lucioasă)

i Furnizat cu holsurub si diblu

Cod	Dimensiune	Pret €	Ambalare
045 0584	16 x 2,0 - 1/2"		1/100
045 0628	20 x 2,0 - 1/2"		1/100

**1603**

Cot dublu

Cod	Dimensiune	Pret €	Ambalare
160 0008	16 x 16		10/100
160 0014	20 x 20		5/50
160 0105	25 x 25		5/50
160 0019	26 x 26		5/50
160 0036	32 x 32		5/25
340 0017	40 x 40		2/10
340 0020	50 x 50		2/6
340 0024	63 x 63		1/4
340 0059	75 x 75		1/4
340 0127	90 x 90		1/3

De utilizat obligatoriu cu art. 1476

Varianta galbena la cerere

**1626**

Cot F, dublu cu flansa

Cod	Dimensiune	Pret €	Ambalare
160 0063	16 x 1/2" x 16		5/60
160 0165	16 x 3/4" x 16		5/50
160 0106	20 x 1/2" x 20		5/40

**1608**

Teu M

Cod	Dimensiune	Pret €	Ambalare
160 0038	16 x 1/2" x 16		5/100
160 0058	20 x 1/2" x 20		5/50
160 0076	20 x 3/4" x 20		5/50
160 0129	25 x 3/4" x 25		5/50
160 0132	25 x 1" x 25		5/45
160 0070	26 x 3/4" x 26		5/50
160 0087	26 x 1" x 26		5/45
160 0085	32 x 1" x 32		5/20
340 0075	40 x 1" 1/4 x 40		2/10
340 0086	50 x 1" 1/2 x 50		2/8
340 0090	63 x 2" x 63		1/5
340 0130	75 x 2" x 75		1/3
340 0131	90 x 2" x 90		1/2

De utilizat obligatoriu cu art. 1476

**1619**

Teu cu filet lateral M nichelat

Cod	Dimensiune	Pret €	Ambalare
160 0194	16 x 16 x 1/2"		5/50
160 0195	20 x 20 x 3/4"		5/50



1609
Teu F

Cod	Dimensiune	Pret €	Ambalare
160 0018	16 x 1/2" x 16		5/50
160 0049	20 x 1/2" x 20		5/50
160 0032	20 x 3/4" x 20		5/50
160 0107	25 x 3/4" x 25		5/25
160 0123	25 x 1" x 25		5/25
160 0174	26 x 1/2" x 26		5/25
160 0033	26 x 3/4" x 26		5/25
160 0079	26 x 1" x 26		5/25
160 0048	32 x 1" x 32		5/20
340 0045	40 x 1" 1/4 x 40		2/8
340 0049	50 x 1" 1/2 x 50		2/6
340 0058	63 x 2" x 63		1/3
340 0085	75 x 2" x 75		1/3
340 0084	90 x 2" 1/2 x 90		1/2

De utilizat obligatoriu cu art. 1476



1620
Teu cu filet lateral F nichelat

Cod	Dimensiune	Pret €	Ambalare
160 0192	16 x 16 x 1/2"		5/50
160 0193	20 x 20 x 3/4"		5/50



1607
Teu

Cod	Dimensiune			Pret €	Ambalare
	1	2	3		
160 0002	16	16	16		5/50
160 0009	20	20	20		5/50
160 0101	25	25	25		5/25
160 0030	26	26	26		5/25
160 0054	32	32	32		5/15
340 0050	40	40	40		2/6
340 0055	50	50	50		2/4
340 0060	63	63	63		1/2
340 0083	75	75	75		1/2
340 0081	90	90	90		1/1
Redus					
160 0078	16	20	16		5/50
160 0181	16	26	16		5/50
160 0044	20	16	16		5/50
160 0017	20	16	20		5/50
160 0057	20	20	16		5/50
160 0089	20	26	20		5/50
160 0433	25	16	20		5/50
160 0432	25	16	25		5/25
160 0431	25	20	20		5/25
160 0177	26	16	16		5/25
160 0183	26	16	20		5/50
160 0043	26	16	26		5/25
160 0184	26	20	16		5/50
160 0080	26	20	20		5/25
160 0037	26	20	26		5/25
160 0175	26	26	16		5/25
160 0090	26	26	20		5/25
160 0182	26	32	26		5/20
160 0179	32	16	32		5/25
160 0178	32	20	20		5/25
160 0185	32	20	26		5/25
160 0062	32	20	32		5/25
160 0095	32	26	26		5/20
160 0082	32	26	32		5/20
160 0176	32	32	20		5/25
160 0180	32	32	26		5/20

De utilizat obligatoriu cu art. 1476

Varianta galbena la cerere





1610
Cruce

Cod	Dimensiune	Pret €	Ambalare
160 0071	16 x 16 x 16 x 16		5/50
160 0088	20 x 20 x 20 x 20		5/40



1611
Dop final

Cod	Dimensiune	Pret €	Ambalare
160 0083	16		10/100
160 0102	20		5/100
160 0191	25		5/50



1481
Placa pentru cot cu flansa

1606 - 1626

Cod	Dimensiune	Pret €	Ambalare
147 0005	unica		1/100



1476
Stut cu garnituri pentru tub multistrat

i Articolul obligatoriu în cazul utilizării fittingurilor din seria 1600 cu tubul multistrat cu dimensiuni de Ø 40, 50, 63, 75 și 90 mm

i "Dimensiune" se referă la dimensiunile tubului

+ CU FUNCȚIE DIELECTRICĂ

Cod	Dimensiune	Pret €	Ambalare
340 0067	40 x 3,5		10/60
340 0080	50 x 4,0		5/30
340 0087	63 x 4,5		1/25
340 0178	75 x 5,0		1/20
340 0179	90 x 7,0		1/15



H9300
O-ring

Cod	Dimensiune	Pret €	Ambalare
040 0100	16		250/1500
040 0101	20		250/1500
040 0102	25-26		250/1500
040 0103	32		250/1500



1416
Inel din alama

Cod	Dimensiune	Pret €	Ambalare
140 0159	16		50/2300
140 0204	20		50/1200
140 0225	25		50/800
140 0637	26		50/800
140 0220	32		10/400



**2143**

Robinet pentru tub multistrat cu maneta de aluminiu de culoare rosie

Cod	Dimensiune	Pret €	Ambalare
162 0022	16 x 2,0		20/80
162 0005	20 x 2,0		15/60

**2153**

Robinet pentru tub multistrat cu maneta tip fluture de culoare rosie și albastra

Cod	Dimensiune	Pret €	Ambalare
 maneta tip fluture rosie			
162 0020	16 x 2,0		20/80
162 0003	20 x 2,0		15/60
162 0084	26 x 3,0		10/40
 maneta tip fluture albastra			
162 0021	16 x 2,0		20/80
162 0053	20 x 2,0		15/60
162 0086	26 x 3,0		10/40



**2163**

Robinet pentru tub multistrat cu maneta de otel de culoare rosie

Cod	Dimensiune	Pret €	Ambalare
162 0023	16 x 2,0		20/80
162 0007	20 x 2,0		15/60
162 0087	26 x 3,0		10/40



**2153FLR**

Robinet pentru tub multistrat cu maneta tip fluture de culoare rosie și albastra

Cod	Dimensiune	Pret €	Ambalare
 maneta tip fluture rosie			
162 0029	16 x 2,0		20/80
162 0031	20 x 2,0		15/60
 maneta tip fluture albastra			
162 0030	16 x 2,0		20/80
162 0032	20 x 2,0		15/60



**2154R**

Robinet M pentru tub multistrat cu maneta tip fluture de culoare rosie și albastra

Cod	Dimensiune	Pret €	Ambalare
 maneta tip fluture rosie			
162 0025	16 x 2,0 - 1/2"		20/80
162 0037	20 x 2,0 - 3/4"		15/60
162 0092	26 x 3,0 - 1"		10/40
 maneta tip fluture albastra			
162 0026	16 x 2,0 - 1/2"		20/80
162 0038	20 x 2,0 - 3/4"		15/60
162 0093	26 x 3,0 - 1"		10/40



**2154FLR**

Robinet M pentru tub multistrat cu maneta tip fluture de culoare rosie și albastra

Cod	Dimensiune	Pret €	Ambalare
 maneta tip fluture rosie			
162 0035	16 x 2,0 - 1/2"		20/80
162 0041	20 x 2,0 - 3/4"		15/60
 maneta tip fluture albastra			
162 0036	16 x 2,0 - 1/2"		20/80
162 0042	20 x 2,0 - 3/4"		15/60



**2155R**

Robinet F pentru tub multistrat cu maneta tip fluture de culoare rosie și albastra

Cod	Dimensiune	Pret €	Ambalare
 maneta tip fluture rosie			
162 0027	16 x 2,0 - 1/2"		20/80
162 0039	20 x 2,0 - 3/4"		15/60
162 0100	26 x 3,0 - 1"		10/40
 maneta tip fluture albastra			
162 0028	16 x 2,0 - 1/2"		20/80
162 0040	20 x 2,0 - 3/4"		15/60
162 0101	26 x 3,0 - 1"		10/40



**2155FLR**

Robinet F pentru tub multistrat cu maneta tip fluture de culoare rosie și albastra

Cod	Dimensiune	Pret €	Ambalare
 maneta tip fluture rosie			
162 0033	16 x 2,0 - 1/2"		20/80
162 0043	20 x 2,0 - 3/4"		15/60
 maneta tip fluture albastra			
162 0034	16 x 2,0 - 1/2"		20/80
162 0044	20 x 2,0 - 3/4"		15/60

**2161**

Robinet pentru tub multistrat cu maneta de aluminiu si piulita

Cod	Dimensiune	Pret €	Ambalare
 maneta tip levier rosie			
162 0122	26 x 3,0 - 3/4"		10/40
162 0124	26 x 3,0 - 1"		10/40
 maneta tip levier albastra			
162 0121	26 x 3,0 - 3/4"		10/40
162 0123	26 x 3,0 - 1"		10/40



**2160**

Robinet pentru tub multistrat cu maneta tip fluture si piulita

Cod	Dimensiune	Pret €	Ambalare
 maneta tip fluture rosie			
162 0112	16 x 2,0 - 1/2"		20/80
162 0114	16 x 2,0 - 3/4"		15/60
162 0116	20 x 2,0 - 3/4"		15/60
162 0118	26 x 3,0 - 3/4"		10/40
162 0120	26 x 3,0 - 1"		10/40
 maneta tip fluture albastra			
162 0111	16 x 2,0 - 1/2"		20/80
162 0113	16 x 2,0 - 3/4"		15/60
162 0115	20 x 2,0 - 3/4"		15/60
162 0117	26 x 3,0 - 3/4"		10/40
162 0119	26 x 3,0 - 1"		10/40



**2156R**

Robinet de colt M pentru tub multistrat cu maneta tip fluture de culoare rosie și albastra

Cod	Dimensiune	Pret €	Ambalare
 maneta tip fluture rosie			
162 0051	20 x 2,0 - 3/4"		15/60
 maneta tip fluture albastra			
162 0052	20 x 2,0 - 3/4"		15/60

**2157R**

Robinet de colt pentru tub multistrat cu maneta tip fluture de culoare rosie, albastra si piulita

Cod	Dimensiune	Pret €	Ambalare
	maneta tip fluture rosie		
162 0047	20 x 2,0 - 3/4"		10/40
162 0060	20 x 2,0 - 1"		10/40
162 0049	26 x 3,0 - 3/4"		10/40
162 0062	26 x 3,0 - 1"		10/40
	maneta tip fluture albastra		
162 0048	20 x 2,0 - 3/4"		10/40
162 0061	20 x 2,0 - 1"		10/40
162 0050	26 x 3,0 - 3/4"		10/40
162 0063	26 x 3,0 - 1"		10/40

**0191X**



Pereche racorduri flexibile din otel inox DN8 pentru tub multistrat Ø16x2,0 si M10x1

Cod	Dimensiune	Pret €	Ambalare
019 0009	L = 30 cm		1/20

**2181CPR**

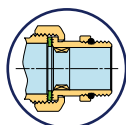

Robinet de colt pentru tub multistrat cu racord olandez, **GARNITURA PLATA** cu pre-etansare



Cod	Dimensiune	Pret €	Ambalare
	maneta tip fluture rosie		
162 0045	20 x 3/4"		10/40
162 0014	26 x 3/4"		10/40
162 0010	26 x 1"		5/20
162 0015	32 x 1"		5/20
	maneta tip fluture albastra		
162 0046	20 x 3/4"		10/40
162 0004	26 x 3/4"		10/40
162 0009	26 x 1"		5/20
162 0013	32 x 1"		5/20



**2944**

Minirobinet cu sfera pentru tub multistrat cu maneta aluminiu de culoare rosie sau albastra

Cod	Dimensiune	Pret €	Ambalare
	maneta tip fluture rosie		
294 0029	16 x 2,0 - 1/2"		25/100
	maneta tip fluture albastra		
294 0028	16 x 2,0 - 1/2"		25/100

**2944K**

Minirobinet cu sfera cromata pentru tub multistrat cu maneta aluminiu de culoare rosie sau albastra

Cod	Dimensiune	Pret €	Ambalare
	maneta tip fluture rosie		
294 0026	16 x 2,0 - 1/2"		1/50
	maneta tip fluture albastra		
294 0027	16 x 2,0 - 1/2"		1/50



LISTA DE PRETURI

INSTRUCTIUNI DE MONTAJ Ø14 - Ø32

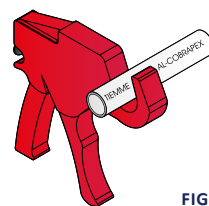
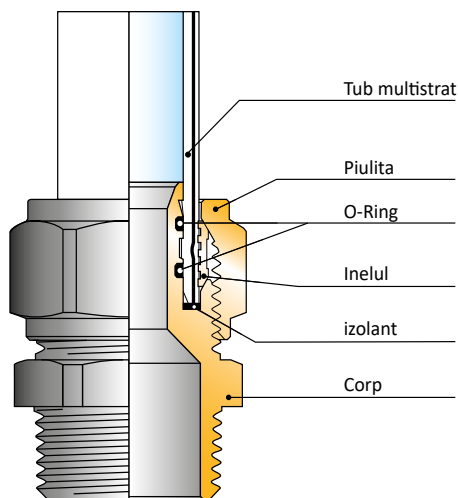

FIG. 1

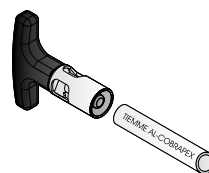

FIG. 2

Pentru a obtine o imbinare perfecta si in functie de tipul de racord care va fi utilizat, trebuie indeplinite urmatoarele operatii simple dar importante.

TAIEREA TUBULUI

In primul rand, taiati tubul la marimea dorita, folosind o foarfeca speciala pentru tuburi, avand grija ca taietura sa se faca perpendicular pe axa tubului (FIG. 1)

DEBAVURAREA SI CURATIREA TUBULUI

Apoi, calibrati si debavurati tubul, folosind calibratorul debavurator din FIG. 2. Se introduce calibratorul in tub si se roteste in sensul acelor de ceas si in sens invers.

MONTAJUL RACORDULUI

In cazul racordurilor mecanice prin compresie, introduceti pe tub toate componentele racordului; in ordinea:

1. piulita de strangere
2. inelul de strangere

Introduceti tubul pe racord pana la inelul izolant; strangeti piulita cu mana cat este posibil si apoi strangeti piulita cu cheia, conform numarului de rotatii din tabelul de mai jos.

TABEL DE STRANGERE PIULITA - Nr. rotatii

Dimensiune	16	20	25	26	32
Nr. rotatii	1 1/4	1	1	1	1

INSTRUCTIUNI DE MONTAJ Ø40 - Ø63

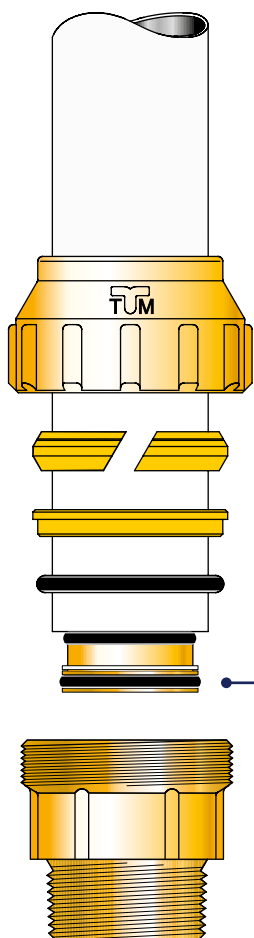

Art. 1476
Stut cu garnituri pentru tub multistrat
(obligatoriu)

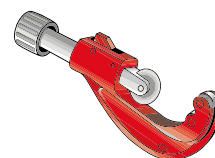

FIG. 1

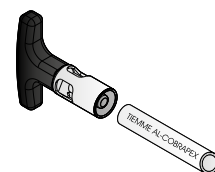

FIG. 2

Pentru a obtine o imbinare perfecta si in functie de tipul de racord care va fi utilizat, trebuie indeplinite urmatoarele operatii simple dar importante.

TAIEREA TUBULUI

In primul rand, taiati tubul la marimea dorita, folosind o foarfeca speciala pentru tuburi, avand grija ca taietura sa se faca perpendicular pe axa tubului (FIG. 1)

DEBAVURAREA SI CURATAREA TEVII

Apoi, calibrati si debavurati tubul, folosind calibratorul debavurator din FIG. 2. Se introduce calibratorul in tub si se roteste in sensul acelor de ceas si in sens invers.

MONTAJUL RACORDULUI

Introduceti piulita si o-ring-ul sectionat pe tub, montati-l la extremitatea tubului, asigurandu-va ca nu rupeti garnitura in scaunul fittingului. Insurubati piulita manual, urmand indicatiile de strangere din tabelul de mai jos.

TABEL DE STRANGERE PIULITA - Nr. rotatii

Dimensiune	40	50	63
Nr. rotatii	1,5	1,5	1,5



03 RACORDURI DE PRESARE PENTRU TUB MULTISTRAT "AL-COBRAPEX"



Seria 1650 - Racorduri de presare pentru apă

Racorduri de presare pentru tub multistrat "AL-COBRAPEX" - COMPACT		70
Racorduri de presare pentru tub multistrat "AL-COBRAPEX"		72
Accesorii si piese de schimb		88
Robineti de presare pentru tub multistrat "AL-COBRAPEX"		89

GHID DE COMPATIBILITATE

Seria	Tub potrivit	Domeniu de aplicare	Caracteristici tehnice
1650	Multistrat "AL-COBRAPEX"	• Apa	Tmax: + 95 °C Pmax: 10 bar

Pentru detalii suplimentare consultati fisa tehnica



1650CT
Racord drept M

i Disponibil si in varianta staniu

Cod	Dimensiune	Pret €	Ambalare
166 0004	16 x 2,0 - 1/2"		10/100
166 0031	16 x 2,0 - 3/4"		10/100
166 0006	20 x 2,0 - 1/2"		10/100
166 0018	20 x 2,0 - 3/4"		10/100
166 0089	20 x 2,25 - 1/2"		10/100
166 0090	20 x 2,25 - 3/4"		10/100
166 0093	20 x 2,5 - 1/2"		10/100
166 0094	20 x 2,5 - 3/4"		10/100
166 0124	25 x 2,5 - 1/2"		10/50
166 0070	25 x 2,5 - 3/4"		10/50
166 0071	25 x 2,5 - 1"		5/25
166 0012	26 x 3,0 - 3/4"		10/50
166 0064	26 x 3,0 - 1"		5/25
166 0021	32 x 3,0 - 1"		5/25



1652CT
Racord drept F

i Disponibil si in varianta staniu

Cod	Dimensiune	Pret €	Ambalare
166 0009	16 x 2,0 - 1/2"		10/100
166 0010	20 x 2,0 - 1/2"		10/100
166 0092	20 x 2,25 - 1/2"		10/100
166 0193	20 x 2,25 - 3/4"		5/25
166 0096	20 x 2,5 - 1/2"		10/100
166 0125	25 x 2,5 - 1/2"		5/50
166 0016	26 x 3,0 - 3/4"		5/25
166 0065	26 x 3,0 - 1"		5/25
166 0066	32 x 3,0 - 1"		5/25



1651CT
Racord drept dublu

i Disponibil si in varianta staniu

Cod	Dimensiune	Pret €	Ambalare
166 0015	16 x 2,0 - 16 x 2,0		10/100
166 0173	16 x 2,0 - 20 x 2,25		10/100
166 0019	20 x 2,0 - 20 x 2,0		10/100
166 0097	20 x 2,0 - 20 x 2,25		10/100
166 0098	20 x 2,0 - 20 x 2,5		10/100
166 0091	20 x 2,25 - 20 x 2,25		10/100
166 0175	20 x 2,25 - 25 x 2,5		5/50
166 0095	20 x 2,5 - 20 x 2,5		10/100
166 0072	25 x 2,5 - 25 x 2,5		5/50
166 0026	26 x 3,0 - 26 x 3,0		5/50
166 0028	32 x 3,0 - 32 x 3,0		5/25



1654CT
Cot M

i Disponibil si in varianta staniu

Cod	Dimensiune	Pret €	Ambalare
166 0008	16 x 2,0 - 1/2"		10/100
166 0022	20 x 2,0 - 1/2"		10/100
166 0127	20 x 2,5 - 1/2"		10/100
166 0029	20 x 2,0 - 3/4"		10/50
166 0025	26 x 3,0 - 3/4"		5/50
166 0030	32 x 3,0 - 1"		5/25

IDENTIFICATI GROSIMEA TUBULUI PENTRU RACORDURILE SERIA COMPACT



20 x 2,0



20 x 2,25



20 x 2,5

Versiunea galbena



Versiunea placata
cu staniu



LISTA DE PRETURI

**1655CT**

Cot F

Disponibil si in varianta staniu

Cod	Dimensiune	Pret €	Ambalare
166 0003	16 x 2,0 - 1/2"		10/100
166 0007	20 x 2,0 - 1/2"		10/100
166 0167	20 x 2,0 - 3/4"		10/100
166 0191	20 x 2,25 - 1/2"		10/100
166 0128	20 x 2,5 - 1/2"		10/100
166 0073	25 x 2,5 - 3/4"		5/25
166 0014	26 x 3,0 - 3/4"		5/25
166 0027	32 x 3,0 - 1"		5/25

**1656DFCT**

Cot F cu flansa cu 2 gauri de prindere

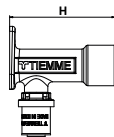

Disponibil si in varianta staniu

Cod	Dimensiune	H	Pret €	Ambalare
166 0005	16 x 2,0 - 1/2"	40 mm		10/50
166 0023	20 x 2,0 - 1/2"	40 mm		10/50
166 0169	20 x 2,25 - 1/2"	40 mm		10/50

**1653CT**

Cot dublu

Disponibil si in varianta staniu

Cod	Dimensiune	Pret €	Ambalare
166 0101	20 x 2,0 - 20 x 2,5		10/100
166 0100	20 x 2,25 - 20 x 2,25		10/100
166 0099	20 x 2,5 - 20 x 2,5		10/100

**1659CT**

Teu F

Disponibil si in varianta staniu

Cod	Dimensiune	Pret €	Ambalare
166 0011	16 x 2,0 - 1/2" - 16 x 2,0		10/100
166 0020	20 x 2,0 - 1/2" - 20 x 2,0		10/100
166 0181	20 x 2,25 - 1/2" - 20 x 2,25		10/100
166 0032	26 x 3,0 - 3/4" - 26 x 3,0		5/25
166 0034	32 x 3,0 - 1" - 32 x 3,0		5/25

**1657CT**

Teu

Disponibil si in varianta staniu

Cod	Dimensiune			Pret €	Ambalare
	1	2	3		
166 0001	16 x 2,0	16 x 2,0	16 x 2,0		10/50
166 0179	16 x 2,0	16 x 2,0	20 x 2,25		5/50
166 0002	20 x 2,0	20 x 2,0	20 x 2,0		5/50
166 0183	20 x 2,25	16 x 2,0	20 x 2,25		5/50
166 0185	20 x 2,25	20 x 2,25	16 x 2		5/50
166 0177	20 x 2,25	20 x 2,25	20 x 2,25		5/50
166 0126	20 x 2,5	20 x 2,5	20 x 2,5		5/50
166 0187	25 x 2,5	20 x 2,25	20 x 2,25		5/25
166 0189	25 x 2,5	20 x 2,25	25 x 2,5		5/25
166 0074	25 x 2,5	25 x 2,5	25 x 2,5		5/25
166 0017	26 x 3,0	26 x 3,0	26 x 3,0		5/25
166 0076	32 x 3,0	25 x 2,5	25 x 2,5		5/25
166 0075	32 x 3,0	25 x 2,5	32 x 3,0		5/25
166 0078	32 x 3,0	26 x 3,0	26 x 3,0		5/25
166 0077	32 x 3,0	26 x 3,0	32 x 3,0		5/25
166 0024	32 x 3,0	32 x 3,0	32 x 3,0		5/25



1650
Racord drept M

i Disponibil si in varianta staniu

Cod	Dimensiune	Pret €	Ambalare
165 0262	16 x 3/8"		10/100
165 0009	16 x 1/2"		10/100
165 0091	16 x 3/4"		10/100
165 0014	20 x 1/2"		10/100
165 0015	20 x 3/4"		10/100
165 0219	25 x 3/4"		10/50
165 0245	25 x 1"		5/25
165 0180	26 x 1/2"		10/50
165 0007	26 x 3/4"		10/50
165 0027	26 x 1"		5/25
165 0032	32 x 1"		5/25
165 0121	32 x 1"1/4		5/25
165 0065	40 x 1"1/4		5/25
165 1410	50 x 1"		1/16
165 0084	50 x 1"1/2		1/16
165 0089	63 x 2"		1/16
165 1109	75 x 2"1/2		1/10
165 1263	90 x 3"		1/1

La cerere



1652
Racord drept F

i Disponibil si in varianta staniu

Cod	Dimensiune	Pret €	Ambalare
165 0030	16 x 1/2"		10/100
165 0116	16 x 3/4"		10/100
165 0025	20 x 1/2"		10/100
165 1237	20 (2,25) x 3/4"		10/100
165 0033	20 x 3/4"		10/100
165 0253	25 x 3/4"		5/25
165 0268	25 x 1"		5/25
165 0020	26 x 3/4"		5/25
165 0053	26 x 1"		5/25
165 0050	32 x 1"		5/25
165 0139	32 x 1"1/4		5/25
165 0094	40 x 1"1/4		5/25
165 1217	40 x 1"1/2		5/25
165 0122	50 x 1"1/2		1/16
165 1218	63 x 2"		1/16
165 1110	75 x 2"1/2		1/10
165 1262	90 x 3"		1/1

La cerere



1651
Racord drept dublu

i Disponibil si in varianta staniu

Cod	Dimensiune	Pret €	Ambalare
165 0016	16 x 16		10/100
165 0022	20 x 20		10/100
165 0212	25 x 25		5/50
165 0037	26 x 26		5/50
165 0051	32 x 32		5/25
165 0059	40 x 40		5/25
165 0060	50 x 50		1/16
165 0068	63 x 63		1/16
165 1111	75 x 75		1/10
165 1254	90 x 90		1/1



1651 - Racord drept redus

Cod	Dimensiune	Pret €	Ambalare
Redus			
165 0040	20 x 16		10/100
165 0333	25 x 16		10/100
165 0228	25 x 20		10/100
165 0093	26 x 16		10/100
165 0052	26 x 20		10/100
165 0337	26 x 25		5/50
165 0186	32 x 16		5/25
165 0115	32 x 20		5/25
165 0288	32 x 25		5/25
165 0067	32 x 26		5/25
165 1046	40 x 25		5/25
165 0150	40 x 26		5/25
165 0103	40 x 32		5/25
165 1409	50 x 20		1/16
165 0154	50 x 32		1/16
165 0126	50 x 40		1/16
165 0170	63 x 40		1/16
165 0145	63 x 50		1/16
165 1113	75 x 50		1/2
165 1112	75 x 63		1/10
165 1261	90 x 63		1/1
165 1256	90 x 75		1/1

La cerere



1671
Prelungitor de reparatii

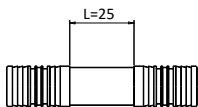

i Lungimea de tăiere = 25mm

Cod	Dimensiune	Pret €	Ambalare
165 0202	16		5/100
165 0200	20		5/100

**1667**

Racord drept M cu conector cu piulita

i Disponibil si in varianta staniu

Cod	Dimensiune	Pret €	Ambalare
165 0217	16 x 1/2"		10/100
165 0273	16 x 3/4"		10/100
165 0250	20 x 1/2"		5/100
165 0235	20 x 3/4"		5/100
165 0237	26 x 3/4"		5/25
165 0286	26 x 1"		5/25
165 0254	32 x 1"		1/40

**1668**

Racord drept cu conector cu piulita pentru conexiuni 1/2"x16 si M22x16

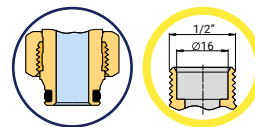

i Disponibil si in varianta staniu

Cod	Dimensiune	Pret €	Ambalare
165 0028	16 x 1/2" (ø16)		10/100
165 0077	20 x 1/2" (ø16)		10/100
Versiunea nichelata			
165 0299	16 x M22 (ø16)		5/200

Pina la terminarea stocului

**1694**

Racord drept cu conector cu piulita pentru conexiuni 1/2"x15

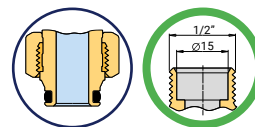

i Disponibil si in varianta staniu

Cod	Dimensiune	Pret €	Ambalare
165 0141	16 x 1/2" (ø15)		10/100
165 0264	20 x 1/2" (ø15)		10/100

**1666**

Racord drept cu piulita pentru
conectare 3/4"x18 (Eurocono)

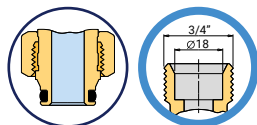

i Disponibil si in varianta staniu

Cod	Dimensiune	Pret €	Ambalare
165 0076	16 x 3/4" (ø18)		10/100
165 0110	20 x 3/4" (ø18)		10/100

**1666K24**

Racord drept cu piulita pentru
conexiuni 24x19 fil (ø18)
Versiunea cromata

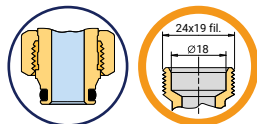

Cod	Dimensiune	Pret €	Ambalare
165 0158	16 - 24 x 19 fil (ø18)		10/100
165 0272	20 - 24 x 19 fil (ø18)		10/100

**1665**

Racord drept cu piulita si
garnitura plata

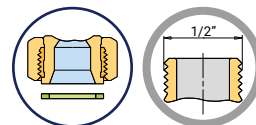

i Disponibil si in varianta staniu

Cod	Dimensiune	Pret €	Ambalare
165 0256	16 x 3/8"		10/100
165 0034	16 x 1/2"		10/100
165 0133	16 x 3/4"		10/100
165 0297	16 x 1"		10/100
165 0061	20 x 1/2"		10/100
165 0062	20 x 3/4"		10/100
165 1105	20 x 1"		10/100
165 0303	25 x 3/4"		2/100
165 0233	25 x 1"		2/50
165 0072	26 x 3/4"		2/100
165 0071	26 x 1"		2/50
165 0294	26 x 1"1/4		2/90
165 0354	32 x 3/4"		2/100
165 0134	32 x 1"		2/100
165 0161	32 x 1"1/4		2/80
165 0240	32 x 1"1/2		1/50
165 1176	40 x 1"1/4		1/25
165 0239	40 x 1"1/2		1/25
165 1177	50 x 1"1/2		1/30
165 0257	50 x 2"		1/30
165 1178	63 x 2"		1/20
165 0275	63 x 2"1/2		1/20
165 1179	75 x 2"1/2		1/10

**1651FS**

Racord drept dublu tub
multistrat/FASTEC

Cod	Dimensiune	Pret €	Ambalare
165 1039	16 x 2,0 - FASTEC		10/100
165 1040	20 x 2,0 - FASTEC		10/100
165 1041	26 x 3,0 - FASTEC		5/50

**1651KB**

Racord drept dublu tub multistrat/ cupru de compresie

 Disponibil si in varianta staniu

Cod	Dimensiune	Pret €	Ambalare
165 1026	16 x 2,0 - Ø 14		10/100
165 0120	16 x 2,0 - Ø 15		10/100
165 1027	16 x 2,0 - Ø 16		10/100
165 0164	20 x 2,0 - Ø 22		10/100
165 0236	26 x 3,0 - Ø 22		5/25
165 0335	26 x 3,0 - Ø 28		5/25

**1674**

Reductie pentru teava multistrat/piesa de sudura cupru

Cod	Dimensiune	Pret €	Ambalare
165 0270	16 x 2,0 - Ø 15		10/250

**1651CY**

Racord drept tub multistrat/ piesa de sudura cupru

 Disponibil si in varianta staniu

Cod	Dimensiune	Pret €	Ambalare
165 0347	16 x Ø 12		10/100
165 0317	16 x Ø 15		10/100
165 0334	20 x Ø 15		10/100
165 0313	20 x Ø 22		10/100
165 0340	26 x Ø 22		10/100
165 0345	26 x Ø 28		10/100
165 1476	32 x Ø 28		10/100

**1654**

Cot M

 Disponibil si in varianta staniu

Cod	Dimensiune	Pret €	Ambalare
165 1047	16 x 3/8"		10/100
165 0010	16 x 1/2"		10/100
165 0029	20 x 1/2"		10/100
165 0044	20 x 3/4"		10/50
165 0280	25 x 3/4"		5/50
165 0046	26 x 3/4"		5/50
165 1036	26 x 1"		5/50
165 0074	32 x 1"		5/25
165 0152	40 x 1"1/4		5/25
165 0185	50 x 1"1/2		1/8
165 0203	63 x 2"		1/8

**1655**

Cot F

 Disponibil si in varianta staniu

Cod	Dimensiune	Pret €	Ambalare
165 0001	16 x 1/2"		10/100
165 0012	20 x 1/2"		10/100
165 0035	20 x 3/4"		10/50
165 0210	25 x 3/4"		5/25
165 1013	25 x 1"		5/25
165 0023	26 x 3/4"		5/25
165 0080	26 x 1"		5/25
165 0057	32 x 1"		5/25
165 0114	40 x 1"1/4		5/25
165 0163	50 x 1"1/2		1/8



1653
Cot dublu

Disponibil si in varianta staniu

Cod	Dimensiune	Pret €	Ambalare
165 0011	16 x 16		10/100
165 0348	20 x 16		10/100
165 0006	20 x 20		10/100
165 0140	25 x 25		5/25
165 0003	26 x 26		5/25
165 0013	32 x 32		5/25
165 0036	40 x 40		5/25
165 0043	50 x 50		1/8
165 0056	63 x 63		1/8
165 1118	75 x 75		1/2
165 1253	90 x 90		1/1

La cerere



1661
Curba la 45°

Disponibil si in varianta staniu

Cod	Dimensiune	Pret €	Ambalare
165 0197	26 x 26		5/25
165 0176	32 x 32		5/25
165 0124	40 x 40		5/25
165 0144	50 x 50		1/10
165 0172	63 x 63		1/5
165 1117	75 x 75		1/4
165 1264	90 x 90		1/1

La cerere



1669
Cot M cu conector cu piulita

Disponibil si in varianta staniu

Cod	Dimensiune	Pret €	Ambalare
165 0246	26 x 1"		5/25



1660BP
Racord cot cu piulita si garnitura plata

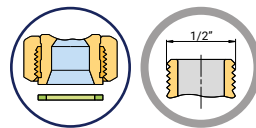

Disponibil si in varianta staniu

Cod	Dimensiune	Pret €	Ambalare
165 1042	16 x 3/8"		5/100
165 0352	16 x 1/2"		5/100
165 0179	16 x 3/4"		5/100
165 1033	20 x 1/2"		5/100
165 0178	20 x 3/4"		5/100
165 1413	20 x 1"		5/50
165 1035	25 x 3/4"		5/50
165 0274	26 x 3/4"		5/50
165 1034	26 x 1"		5/50
165 1043	32 x 1"		5/25
165 1048	32 x 1"1/4		5/25



1660
Racord cot cu conectare cu piulita pentru conexiuni 3/4"x18 Eurocono

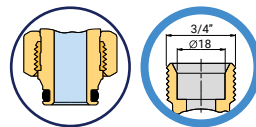

Cod	Dimensiune	Pret €	Ambalare
165 0182	16 x 3/4" (ø18)		5/100
165 0173	20 x 3/4" (ø18)		5/100



1653KB
Cot dublu tub multistrat/cupru de compresie

Disponibil si in varianta staniu

Cod	Dimensiune	Pret €	Ambalare
165 0283	16 x 2,0 - Ø 15		10/100
165 0284	20 x 2,0 - Ø 22		10/100
165 0324	26 x 3,0 - Ø 22		5/25



LISTA DE PREȚURI

1658
Teu M

i Disponibil si in varianta staniu

Cod	Dimensiune	Pret €	Ambalare
165 0085	16 x 1/2" x 16		10/100
165 0092	20 x 1/2" x 20		5/100
165 0131	20 x 3/4" x 20		5/50
165 0149	26 x 1/2" x 26		5/25
165 0098	26 x 3/4" x 26		5/25
165 0167	26 x 1" x 26		5/25
165 0657	32 x 3/4" x 32		5/25
165 0155	32 x 1" x 32		5/25
165 0209	40 x 1"1/4 x 40		1/20

1659
Teu F

i Disponibil si in varianta staniu

Cod	Dimensiune	Pret €	Ambalare
165 0031	16 x 1/2" x 16		10/100
165 0039	20 x 1/2" x 20		5/50
165 0079	20 x 3/4" x 20		5/50
165 0833	25 x 1/2" x 25		5/25
165 0261	25 x 3/4" x 25		5/25
165 0105	26 x 1/2" x 26		5/25
165 0048	26 x 3/4" x 26		5/25
165 0142	32 x 1/2" x 32		5/25
165 0125	32 x 3/4" x 32		5/25
165 0054	32 x 1" x 32		5/25
165 1128	40 x 3/4" x 40		1/20
165 0118	40 x 1" x 40		1/20
165 0112	40 x 1"1/4 x 40		1/20
165 0130	50 x 3/4" x 50		1/10
165 0146	50 x 1" x 50		1/10
165 0162	63 x 1" x 63		1/5
165 1248	63 x 1"1/2 x 63		1/5
165 1122	75 x 1"1/4 x 75		1/5
165 1255	90 x 1" x 90		1/1
165 1268	90 x 1"1/4 x 90		1/1

La cerere

1657
Teu

i Disponibil si in varianta staniu

Cod	Dimensiune			Pret €	Ambalare
	1	2	3		
165 0002	16	16	16		10/50
165 0005	20	20	20		5/50
165 0181	25	25	25		5/25
165 0018	26	26	26		5/25
165 0058	32	32	32		5/25
165 0083	40	40	40		1/20
165 0108	50	50	50		1/10
165 0109	63	63	63		1/5
165 1114	75	75	75		1/5
165 1265	90	90	90		1/1
Redus					
165 0070	16	20	16		5/50
165 0350	16	25	16		5/25
165 0351	16	26	16		5/25
165 0019	20	16	16		5/50
165 0008	20	16	20		5/50
165 0045	20	20	16		5/50
165 0825	20	25	20		5/25
165 0069	20	26	20		5/25
165 0290	25	16	16		5/25
165 0821	25	16	20		5/25
165 0220	25	16	25		5/25
165 0826	25	20	16		5/25
165 0213	25	20	20		5/25
165 0201	25	20	25		5/25
165 0321	25	25	16		5/25
165 0244	25	25	20		5/25
165 0822	25	32	25		5/25
165 0102	26	16	16		5/25
165 0078	26	16	20		5/25
165 0026	26	16	26		5/25
165 0132	26	20	16		5/25
165 0047	26	20	20		5/25
165 0017	26	20	26		5/25
165 0127	26	26	16		5/25
165 0063	26	26	20		5/25
165 0165	26	32	26		5/25
165 0073	32	16	32		5/25
165 0156	32	20	20		5/25
165 0827	32	20	25		5/25

1657 - Racord teu, redus

Cod	Dimensiune			Pret €	Ambalare
	1	2	3		
165 0136	32	x 20	x 26		5/25
165 0055	32	x 20	x 32		5/25
165 1037	32	x 25	x 20		5/25
165 0823	32	x 25	x 25		5/25
165 0828	32	x 25	x 32		5/25
165 0075	32	x 26	x 26		5/25
165 0064	32	x 26	x 32		5/25
165 0143	32	x 32	x 20		5/25
165 0824	32	x 32	x 25		5/25
165 0119	32	x 32	x 26		5/25
165 0199	32	x 40	x 32		1/20
165 0195	40	x 16	x 40		1/20
165 0096	40	x 20	x 40		1/20
165 0829	40	x 25	x 40		1/20
165 0081	40	x 26	x 40		1/20
165 0128	40	x 32	x 32		1/20
165 0095	40	x 32	x 40		1/20
165 0830	40	x 40	x 25		1/20
165 0222	40	x 40	x 26		1/20
165 0192	40	x 40	x 32		1/20
165 0259	40	x 50	x 40		1/10
165 0308	50	x 16	x 50		1/10
165 0168	50	x 20	x 50		1/10
165 0831	50	x 25	x 50		1/10
165 0117	50	x 26	x 50		1/10
165 0123	50	x 32	x 50		1/10
165 0196	50	x 40	x 40		1/10
165 0148	50	x 40	x 50		1/10
165 0230	50	x 50	x 32		1/10
165 0224	50	x 50	x 40		1/10
165 1406	63	x 20	x 63		1/5
165 0832	63	x 25	x 63		1/5
165 0086	63	x 26	x 63		1/5
165 0129	63	x 32	x 63		1/5
165 0147	63	x 40	x 63		1/5
165 0166	63	x 50	x 63		1/5
165 1407	75	x 40	x 75		1/5
165 1116	75	x 50	x 75		1/5
165 1408	75	x 63	x 63		1/5
165 1115	75	x 63	x 75		1/5
165 1266	90	x 63	x 90		1/1
165 1267	90	x 75	x 90		1/1

La cerere

**1687**

Cruce

 Disponibil si in varianta staniu

Cod	Dimensiune	Pret €	Ambalare
165 0307	20 x 16 x 20 x 16		5/25
165 0331	20 x 20 x 16 x 16		5/25
165 0320	20 x 20 x 20 x 20		5/25
165 0378	25 x 16 x 20 x 16		5/20
165 0289	25 x 20 x 16 x 16		5/20
165 0379	25 x 20 x 20 x 20		5/20
165 0380	26 x 16 x 20 x 16		5/20
165 0322	26 x 20 x 16 x 16		5/20
165 0327	26 x 20 x 20 x 20		5/20



LISTA DE PREȚURI

**1656SM**

Cot F cu flansa cu 3 gauri de prindere, cu gat scurt

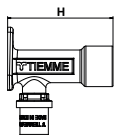

i Disponibil si in varianta staniu

Cod	Dimensiune	H	Pret €	Ambalare
165 0021	16 x 1/2"	40 mm		10/50
165 0088	20 x 1/2"	40 mm		5/50

**1656**

Cot F cu flansa cu 3 gauri de prindere

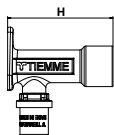

i Disponibil si in varianta staniu

Cod	Dimensiune	H	Pret €	Ambalare
165 0004	16 x 1/2"	52 mm		10/50
165 1044	16 x 3/4"	52 mm		10/50
165 0038	20 x 1/2"	52 mm		5/50
165 1045	20 x 3/4"	52 mm		5/50
165 1049	26 x 3/4"	52 mm		5/50

**1656ISOL01**Izolatie acustica
Se foloseste impreuna cu Art. 1656

+ **IZOLARE FONICA PENTRU RACORDURI CU FLANSA**
Seturile de izolare acustica permit reducerea la minim a zgomotului din sistem garantand un confort maxim si in prezenta peretilor subtiri sau a celor din gips carton conform cu normativa DIN 4109.

Cod	Dimensiune	Pret €	Ambalare
165 0305	1/2"		10/50

**1656CE**

Cot F cu flansa cu 3 gauri de prindere

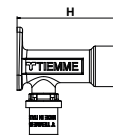

i Disponibil si in varianta staniu

Cod	Dimensiune	H	Pret €	Ambalare
165 1021	16 x 1/2"	52 mm		10/50
165 1022	20 x 1/2"	52 mm		5/50

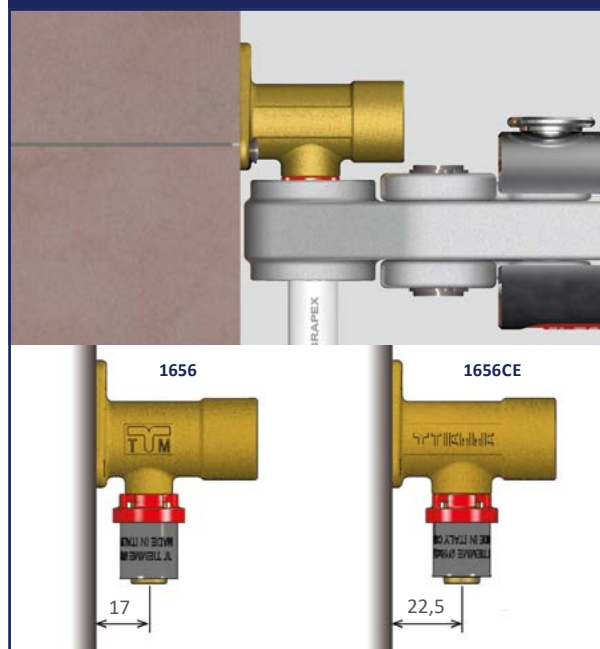
1656CE EXEMPLU DE UTILIZARE**1656XL**

Cot F cu flansa cu 3 gauri de prindere

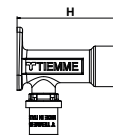

i Disponibil si in varianta staniu

Cod	Dimensiune	H	Pret €	Ambalare
165 0097	16 x 1/2"	77 mm		5/50
165 1192	16 x 1/2"	90 mm		5/50
165 1182	16 x 1/2"	110 mm		5/50

NOU TATI

**1680XL**

Cot M cu flansa cu 3 gauri de prindere, cu gat lung.

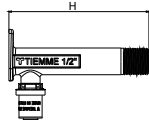

Cod	Dimensiune	H	Pret €	Ambalare
165 1189	16 x 1/2"	70 mm		5/50
165 1186	16 x 1/2"	90 mm		5/50
165 1107	16 x 1/2"	110 mm		5/50

**1656ISOL02**

Izolatie acustica

Se foloseste impreuna cu 1656XL

**IZOLARE FONICA PENTRU RACORDURI CU FLANSA**

Seturile de izolare acustica permit reducerea la minim a zgomotului din sistem garantand un confort maxim si in prezenta peretilor subtiri sau a celor din gips carton conform cu normativa DIN 4109.

Cod	Dimensiune	Pret €	Ambalare
165 0344	1/2" - 77 mm		10/50

1656ISOL01
1656ISOL02

EXEMPLU DE UTILIZARE

**1656KB**

Cot cu flansa pentru tub multistrat/teava de cupru

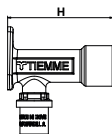

Disponibil si in varianta staniu

Cod	Dimensiune	H	Pret €	Ambalare
165 0306	16 x 15	52 mm		10/50
165 0343	20 x 15	52 mm		5/50

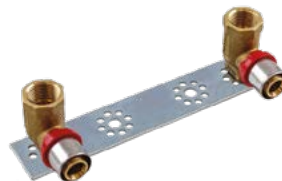
**1664**

Consola cu racorduri finale



Disponibil si in varianta staniu



Interaxe variabile: 100 - 110 - 150 mm

Cod	Dimensiune	Pret €	Ambalare
165 0024	16 x 1/2"		1/40
165 1309	16 x 3/4"		1/20
165 0106	20 x 1/2"		1/20
165 1310	20 x 3/4"		1/20

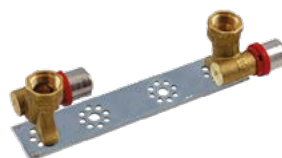
**1664DI**

Consola cu racorduri finale nealinate



Disponibil si in varianta staniu



Interaxe variabile: 100 - 110 - 150 mm

Cod	Dimensiune	Pret €	Ambalare
165 0151	16 x 1/2"		1/10
165 0227	20 x 1/2"		1/10

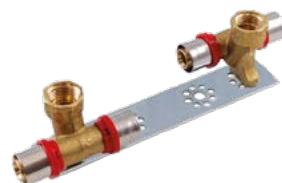
**1663DI**

Consola cu racorduri nealinate pentru conectare in serie



Disponibil si in varianta staniu



Interaxe variabile: 100 - 110 - 150 mm

Cod	Dimensiune	Pret €	Ambalare
165 0082	16 x 1/2"		1/10
165 0137	20 x 1/2"		1/10



**1678**

Consola cu racorduri

i Disponibil si in varianta staniu

Cod	Dimensiune	Pret €	Ambalare
165 0319	16x3/8" Int. 120 mm H = 37		1/25

Pina la terminarea stocului

**1679KB**

Consola cu racorduri pentru tub multistrat Ø16x2,0/teava de cupru Ø15

i Disponibil si in varianta staniu

Cod	Dimensiune	H	Pret €	Ambalare
165 0287	Int. 35	53 mm		1/25
165 0375	Int. 35	65 mm		1/25
165 0376	Int. 38	53 mm		1/25
165 0377	Int. 38	65 mm		1/25
165 0285	Int. 50	53 mm		1/25
165 0329	Int. 50	65 mm		1/25

**1675**

Teu By-pass

Cod	Dimensiune	Pret €	Ambalare
165 0205	16 x 16 x 16		5/15
165 0183	20 x 16 x 16		5/15
165 0157	20 x 16 x 20		5/15
165 0174	20 x 20 x 20		5/15

**1675ISOL**

Izolatie pentru Art. 1675

Cod	Dimensiune	Pret €	Ambalare
159 0045	unica		1/30

EXEMPLU DE INSTALARE

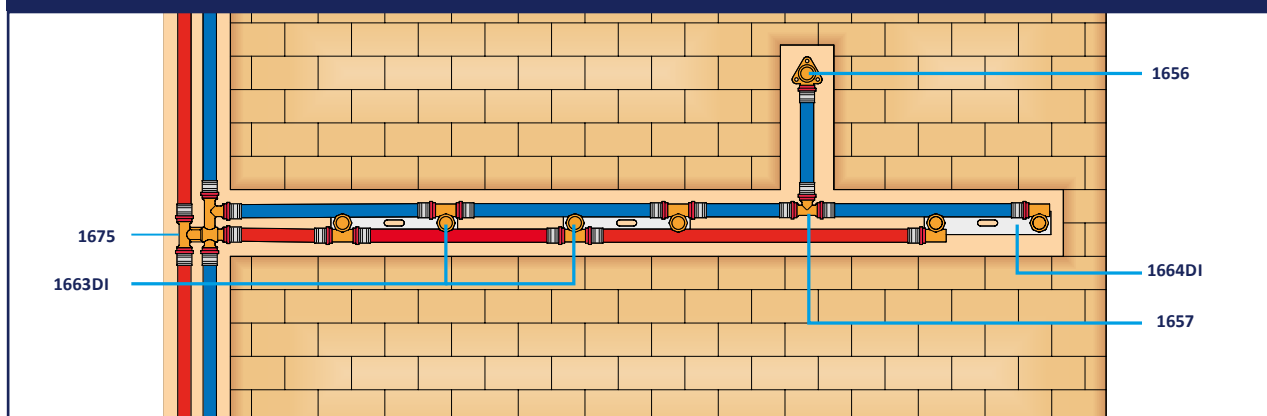

**1676SM**

Cot dublu F cu flansa cu gat scurt

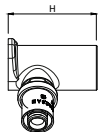

i Disponibil si in varianta staniu

Cod	Dimensiune	H	Pret €	Ambalare
165 0215	16 x 1/2"	40 mm		10/50
165 0267	20 x 1/2"	40 mm		5/50

**1676**

Cot dublu F cu flansa

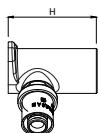

i Disponibil si in varianta staniu

Cod	Dimensiune	H	Pret €	Ambalare
165 0111	16 x 1/2" x 16	52 mm		10/50
165 0171	20 x 1/2" x 20	52 mm		5/50

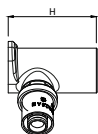
**1676KB**Cot dublu pentru tub multistrat/
teava de cupru

i Disponibil si in varianta staniu

Cod	Dimensiune	H	Pret €	Ambalare
165 0372	16 x 15 x 16	52 mm		10/50
165 0326	20 x 15 x 20	52 mm		5/50

**1676USM**

Cot dublu F cu flansa "U" cu gat scurt.

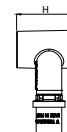

+ ANTI - LEGIONELA

i Disponibil si in varianta staniu

Cod	Dimensiune	H	Pret €	Ambalare
165 1315	16 x 1/2" x 16	40 mm		10/50
165 1317	20 x 1/2" x 20	40 mm		5/50

**1654U**

Cot dublu M "U"

+ ANTI - LEGIONELA

i Disponibil si in varianta staniu

Cod	Dimensiune	Pret €	Ambalare
165 1402	16 x 1/2" x 16		5/50
165 1403	20 x 1/2" x 20		5/50

1676USM
1654U

EXEMPLU DE UTILIZARE

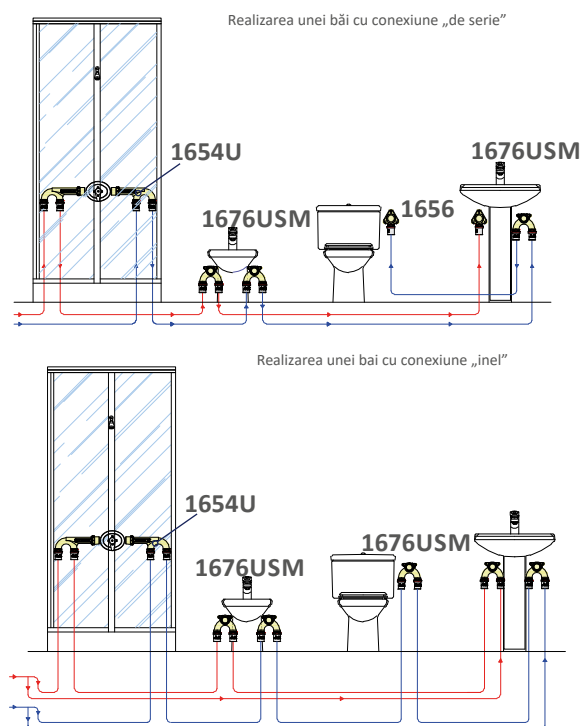

LISTA DE PREȚURI

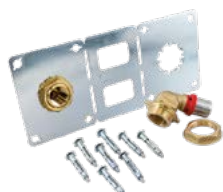
**1664CG**

Consola cu racorduri 105° finale COBRAFIX pentru peretii din ghips sp. 13 mm

BREVETAT

Interaxe: 150 mm

Cod	Dimensiune	Pret €	Ambalare
165 1060	16 x 1/2"		1/5
165 1271	20 x 1/2"		1/5

**1664CG55**

Consola cu racorduri 105° finale COBRAFIX pentru peretii din ghips sp. 13 mm

BREVETAT

Interaxe: 55 mm

Cod	Dimensiune	Pret €	Ambalare
165 1236	16 x 1/2"		1/5
165 1272	20 x 1/2"		1/5

**1664CGXL**

Consola cu racorduri 105° finale COBRAFIX pentru peretii din ghips sp. 20 mm

BREVETAT

Interaxe: 150 mm

Cod	Dimensiune	Pret €	Ambalare
165 1311	16 x 1/2"		1/5
165 1313	20 x 1/2"		1/5

**1664CG55XL**

Consola cu racorduri 105° finale COBRAFIX pentru peretii din ghips sp. 20 mm

BREVETAT

Interaxe: 55 mm

Cod	Dimensiune	Pret €	Ambalare
165 1312	16 x 1/2"		1/5
165 1314	20 x 1/2"		1/5

1664CG
1664CGXL

SECTIUNE

1664CG



Max. 13

1664CGXL

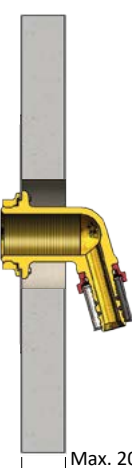

Max. 20

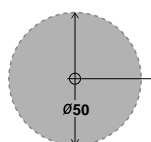

Ø50

150 mm

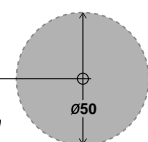

Ø50

1664CG55
1664CG55XL

SECTIUNE

1664CG55



Max. 13

1664CG55XL

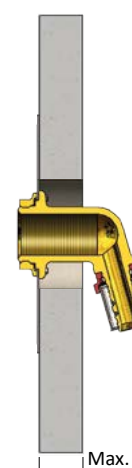

Max. 20

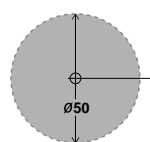

Ø50

55 mm

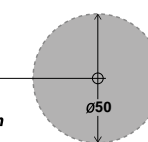

Ø50

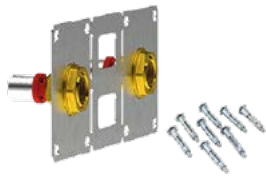
**1652CG**

Consola cu racorduri drepte
finale COBRAFIX pentru peretii
din ghips

 BREVETAT

 Interaxe: 150 mm

Cod	Dimensiune	Pret €	Ambalare
165 1414	16 x 1/2"		1/5

1652CG

SECTIUNE

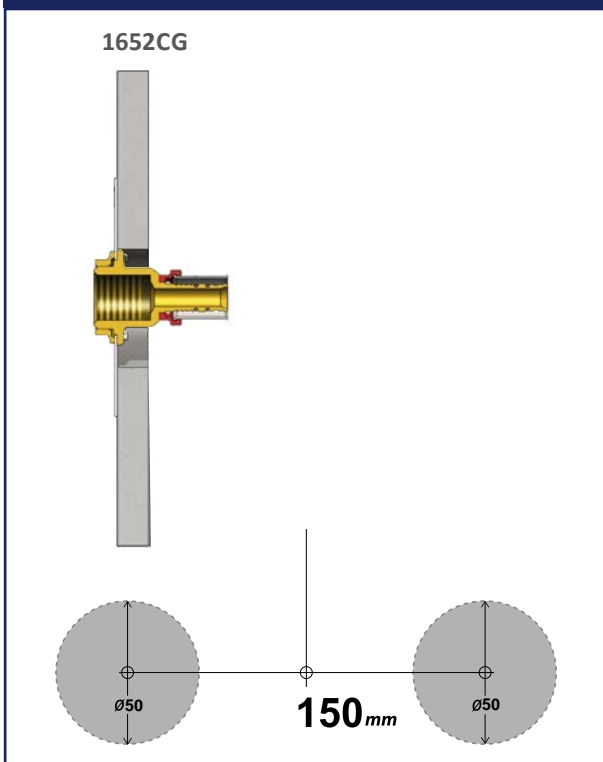
1664CG - 1664CGXL - 1664CG55 - 1664CG55XL - 1652CG
 INSTRUCȚIUNI DE ASAMBLARE

**1662**

Racord cu flansa pentru vas WC ingropat

i Disponibil si in varianta staniu

Cod	Dimensiune	Pret €	Ambalare
165 0175	16 x 1/2"		10/50
165 0260	20 x 1/2"		5/25

**1662CG**

Racord curbat cu flansa prin perete pentru pereți din rigips

Cod	Dimensiune	Pret €	Ambalare
165 1062	16 x 1/2" L=28		1/50

**1662LG**

Racord curbat cu flansa prin perete pentru pereți din lemn

Cod	Dimensiune	Pret €	Ambalare
165 1063	16 x 1/2" L=28		1/50



1688
Colector 5 cai

Disponibil si in varianta staniu

Cod	Dimensiune					Pret €	Ambalare
	1	2	3	4	5		
165 0784	20	20	16	16	16		5/20
165 0785	20	20	20	20	20		5/20
165 0786	25	20	16	16	16		5/20
165 0819	25	20	20	20	20		5/20
165 0787	26	20	16	16	16		5/20
165 0788	26	20	20	20	20		5/20



1672
Cot terminal pentru radiatoare

Cod	Dimensiune	Pret €	Ambalare
Teava de cupru Ø 15 L = 200			
165 0099	16		5/50
Teava de cupru Ø 15 L = 300			
165 0066	16		5/50
165 0194	20		5/50
Teava de cupru Ø 15 L = 1100			
165 0223	16		5/500
165 0312	20		5/500
Teava de cupru Ø 14 L = 300			
165 0138	16		5/50



1672CY
Cot terminal pentru radiatoare

Cod	Dimensiune	Pret €	Ambalare
Teava de cupru Ø 15 L = 160			
165 1028	16		5/50



1673
Teu pentru radiatoare

Cod	Dimensiune	Pret €	Ambalare
Teava de cupru Ø 15 L = 300			
165 0266	16		5/40
165 0229	20		5/40
Teava de cupru Ø 15 L = 1100			
165 0332	16		5/500
165 0293	20		5/500



**1859**

Adaptor pt a transforma un filet EUROCON 3/4x18 in filet cu fata plana

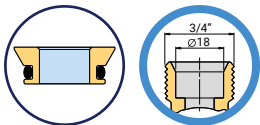

i Disponibil si in varianta staniu

Cod	Dimensiune	Pret €	Ambalare
144 0104	3/4" (ø18)		10/400

**1677**

Racord de capat

i Disponibil si in varianta staniu

Cod	Dimensiune	Pret €	Ambalare
165 0208	16		10/100
165 0216	20		10/100
165 0282	26		5/50
165 0310	32		5/50
165 0315	40		5/25

RACORDURI MULTI-PRESS PANA LA Ø 32

Fitingurile Tiemme sunt proiectate și testate pentru a fi presate cu 6 profile diferite: personalizat TH TIEMME - TH - U - H - B - RF

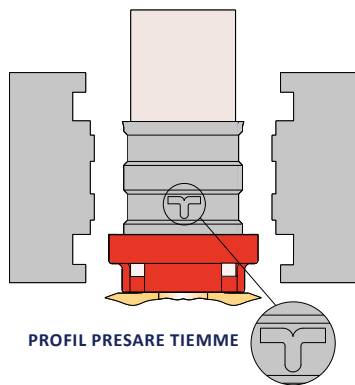

PROFIL PRESARE TIEMME

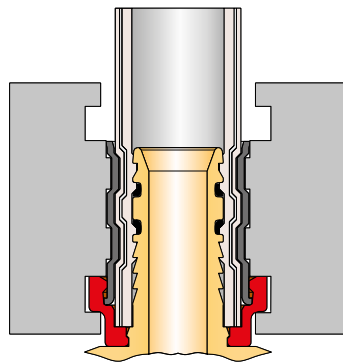

PROFIL PRESARE TIEMME-TH

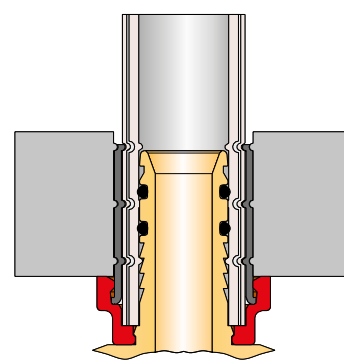

PROFIL PRESARE U

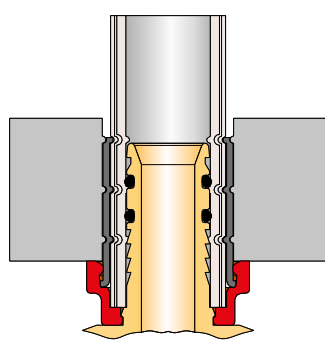

PROFIL PRESARE H

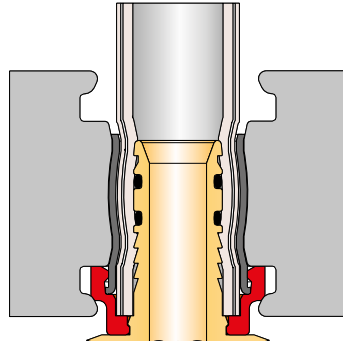

PROFIL PRESARE B

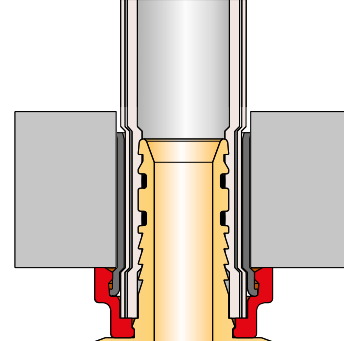

PROFIL PRESARE RF

**1493Z**

Consola pentru art.1656

i Poate fi folosit cu dimensiuni de la \varnothing 14 și \varnothing 16 (\varnothing 20 numai pentru 1656CE)

Cod	Dimensiune	Pret €	Ambalare
159 0016	unica		1/100

1493Z

EXEMPLU DE UTILIZARE

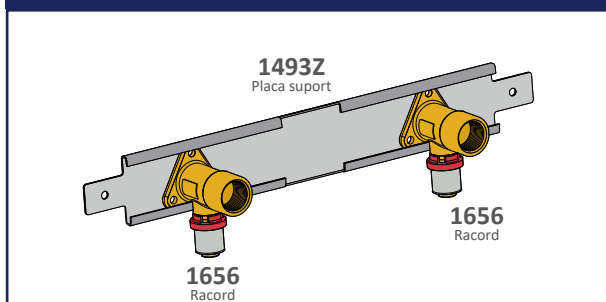
**1481**

Placa pentru cot cu flansa

Cod	Dimensiune	Pret €	Ambalare
147 0005	unica		1/100

1481

EXEMPLU DE UTILIZARE

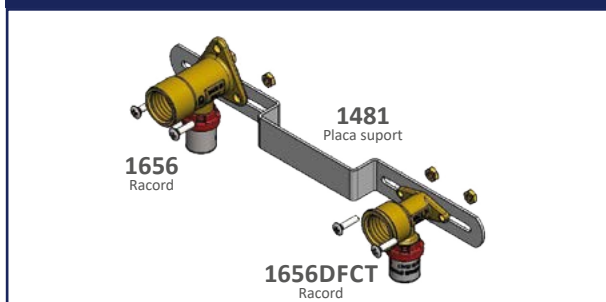
**1670X**

Manson Cobrapress din Inox

i Disponibil si cu inele de plastic albe (1670B)

Cod	Dimensiune	Pret €	Ambalare
165 0184	16		10/350
165 0189	20		10/300
165 0295	25		10/200
165 0187	26		10/200
165 0238	32		10/150
165 0281	40		10/100
165 0291	50		1/50
165 0298	63		1/30
165 1108	75		1/20
165 1269	90		1/1

La cerere

**H9300**

O-ring

Cod	Dimensiune	Pret €	Ambalare
040 0100	16		250/1500
040 0101	20		250/1500
040 0128	25		50/1000
040 0102	26		250/1500
040 0129	32		50/1000
040 0104	40		100/1000
040 0105	50		10/1000
040 0106	63		10/1000



**1697**

Robinet drept cu maneta tip fluture de culoare rosie si piulita

Cod	Dimensiune	Pret €	Ambalare
168 0021	20 x 3/4"		20/80
168 0035	25 x 3/4"		20/80
168 0030	26 x 3/4"		20/80
168 0032	32 x 1"		10/40

**1697CK**

Robinet drept cu maneta tip fluture de culoare rosie, piulita si supapa de sens



i ↗ Directie flux

Cod	Dimensiune	Pret €	Ambalare
168 0029	20 x 3/4"		20/80
168 0027	25 x 3/4"		20/80
168 0036	26 x 3/4"		20/80
168 0037	32 x 1"		10/40

**1691**

Robinet cu sfera cu maneta tip fluture

Cod	Dimensiune	Pret €	Ambalare
168 0010	16 x 16		5/50
168 0007	20 x 20		5/50
168 0025	25 x 25		5/50
168 0008	26 x 26		5/50
168 0087	32 x 32		5/30

Noutati

**1692**

Robinet de colt cu maneta tip fluture de culoare rosie si piulita

i Disponibil cu maneta tip fluture albastra

Cod	Dimensiune	Pret €	Ambalare
maneta tip fluture rosie			
168 0077	16 x 3/4"		10/40
168 0019	20 x 3/4"		10/40
168 0028	25 x 3/4"		10/40
168 0020	26 x 3/4"		10/40
168 0034	32 x 1"		10/40

**1692CK**

Robinet de colt cu maneta tip fluture de culoare rosie, piulita si supapa de sens



i ↗ Directie flux

Cod	Dimensiune	Pret €	Ambalare
168 0026	20 x 3/4"		10/40
168 0018	25 x 3/4"		10/40
168 0031	26 x 3/4"		10/40
168 0022	32 x 1"		10/40

**1690**

Robinet cu sfera de incastat



Cod	Dimensiune	Pret €	Ambalare
168 0002	16 x 16		5/50
168 0001	20 x 20		5/50
168 0009	25 x 25		5/50
168 0003	26 x 26		5/50

**1690U**

Robinet cu sfera de incastat "U"



Cod	Dimensiune	Pret €	Ambalare
168 0013	16 x 16		1/25
168 0011	20 x 20		1/25
168 0016	25 x 25		1/25
168 0033	26 x 26		1/25

**1696**Robinet cu obertein de incastat
2 cai

Cod	Dimensiune	Pret €	Ambalare
168 0012	16 x 16		5/50
168 0014	20 x 20		5/50
168 0024	25 x 25		5/50
168 0023	26 x 26		5/50

**1690 - 1690U
1696**

CONFIGURATII

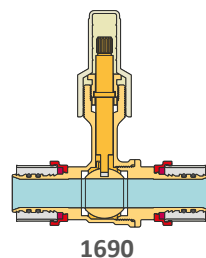

1690

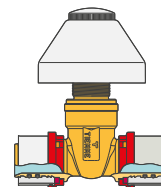
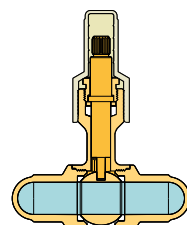
cu
2960SET

1690U

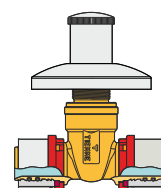
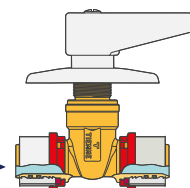
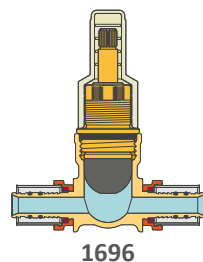
cu
2971SETcu
2961SET

1696

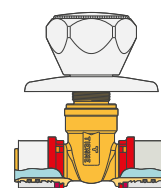
cu
2963SET

**2960SET**

Set format din capac si rozeta pentru robinetii de incastat art. 2960, 1690, 1690U, 1696, 1740, 1740U si 1746

Cod	Dimensiune	Pret €	Ambalare
295 0006	-		1/25

**2963SET**

Set maneta si rozeta decorativa pentru robinetii de incastat art. 2960, 1690, 1690U, 1696, 1740, 1740U si 1746

Cod	Dimensiune	Pret €	Ambalare
295 0014	-		1/25

**2971SET**

Set format din capac si rozeta pentru robinetii de incastat Art. 2960, 1690, 1690U, 1696, 1740, 1740U si 1746

Cod	Dimensiune	Pret €	Ambalare
295 0167	-		1/25

**2960PR**

Set de prelungire pentru robinetii de incastat art. 2960, 1690, 1690U, 1696, 1740, 1740U si 1746

Cod	Dimensiune	Pret €	Ambalare
295 0015	-		1/100

**2961SET**

Set maneta si rozeta decorativa pentru robinetii de incastat art. 2960, 1690, 1690U, 1696, 1740, 1740U si 1746

Cod	Dimensiune	Pret €	Ambalare
295 0009	-		1/25

**1693**

Robinet cu 3 cai – versiunea de
incastrat

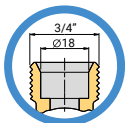

BREVETAT

Cod	Dimensiune	Pret €	Ambalare
168 0005	20 x 16 - 3/4" (ø18)		1/20
168 0006	20 x 20 - 3/4" (ø18)		1/20
168 0015	26 x 20 - 3/4" (ø18)		1/20

**1493SET**

Placa de fixare cu suruburi

Interaxe variabile: 100 - 110 - 150 mm

Cod	Dimensiune	Pret €	Ambalare
159 0034	unica		1/50

**1660**

Cot cu conectare cu piulita
pentru conexiuni 3/4"x18
(Eurocono)

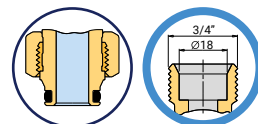

Cod	Dimensiune	Pret €	Ambalare
165 0182	16 x 3/4" (ø18)		5/100
165 0173	20 x 3/4" (ø18)		5/100

**1879**

Racord terminal cu conexiuni
3/4"x18 (EUROCONO)

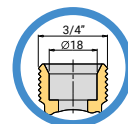

Cod	Dimensiune	Pret €	Ambalare
144 0071	3/4" (ø18)		10/250

**1693PR**

Set prelungitor pentru robineti
îngroptați 1693

Cod	Dimensiune	Pret €	Ambalare
295 0111	-		1/100

1693

EXEMPLU DE INSTALARE: CONSUMATORI IZOLATI SAU PE PARTEA OPUSA

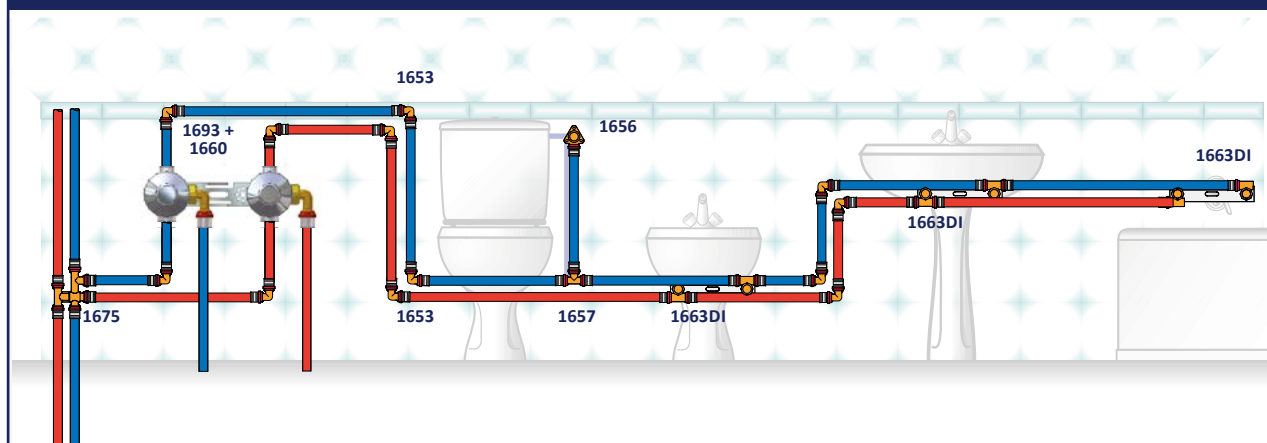

LISTA DE PREȚURI

INSTRUCIUNI DE MONTAJ - SERIA 1650

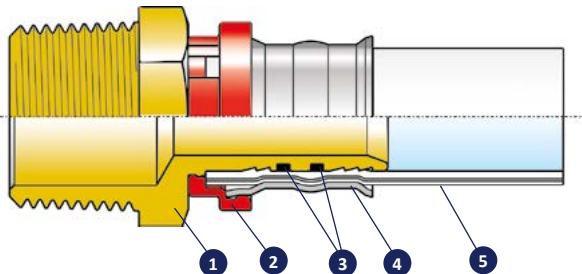

- 1 Corpul racordului din alama
- 2 Inel din plastic, permite sa se vada daca tubul a fost bine introdus in racord si izoleaza dielectric tubul fata de corpul racordului
- 3 Garnituri O-ring din EPDM calitate alimentara
- 4 Manson de sertizare din oțel inox AISI 304
- 5 "AL-COBRAPEX" tub multistrat

Fitingurile de presare se caracterizează prin sistemul de etanșare care se formează prin deformarea mecanică a mansonului exterior din oțel inoxidabil. Această deformare se realizează cu ajutorul unui instrument special echipat cu clești de oțel corespunzător; Procedând astfel, puteți fi sigur că presiunea de strângere rămâne întotdeauna aceeași și la un nivel optim pentru toate fittingurile, sporind fiabilitatea îmbinărilor. Fitingurile de presare Tiemme se caracterizează și prin prezența unui inel de plastic care realizează trei funcții foarte importante. Prima, deoarece este un material plastic, este funcția sa dielectrică, adică nu permite stratului interior de aluminiu al tubului să intre în contact cu corpul fittingului (din alamă) declanșând evitând astfel un posibil efect de pila. A doua funcție, de asemenea de importanță fundamentală, este aceea care permite instalatorului să verifice vizual și ușor dacă și când conducta este introdusă corect în fitting. A treia funcție facilitează poziționarea corectă în interiorul capului de presare Tiemme, aceasta posibilitate de verificare simplă și imediată, garantează o siguranță de instalare față de alte tipuri de fittinguri.

Pentru a obține o îmbinare perfectă trebuie efectuate câteva operații simple, dar importante.

1. TĂIEREA TUBULUI

Mai întâi trebuie să tăiați tubul la dimensiunea dorită. Pentru a efectua tăierea este indicat să folosiți un tăietor de țevi sau foarfeca adecvată, asigurându-vă că tăierea este cât mai perpendiculară pe axa tubului.

2. CALIBRARE ȘI DEBAVURARE

Restabiliți forma tubului folosind calibratorul corespunzător. Acordați o atenție deosebită la efectuarea operațiunii de calibrare și debavurare a țevilor, care urmează să fie efectuate cu sculele adecvate. Orice bavuri reziduale ar putea deteriora o-ring-urile.

3. CONECTAREA TUBULUI LA RACORD

Introduceți tubul în fitting până când ajunge la capăt (verificați prin „fereastra” mansonului inelar).

4. PRESARE

Înainte de a trece la presarea fittingului este necesar să verificați ca mansonul să fie corect asamblat pe locul specific realizat în fittingul din alamă, dacă este cazul este necesară repositionarea mansonului. În cazul instalării subterane cu beton lichid, se recomandă protejarea legăturilor dintre fittinguri și țevă pentru a le izola de eventuale contacte cu materialul.

Vă reamintim că profilul fălcilor ce urmează a fi folosit pentru presarea fittingurilor Tiemme trebuie să fie de tip TH.

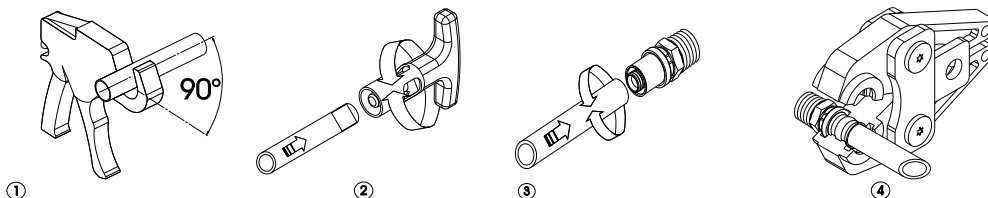

INSTRUCTIUNI PENTRU CORECTA UTILIZARE A PRELUNGITORULUI DE REPARATII 1671

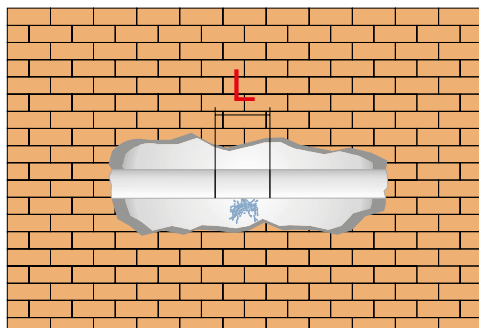

Taiati tubul pe o lungime de aproximativ $L=30\text{mm}$, in vecinatatea zonei unde este avaria. Taietura trebuie sa fie perfect perpendiculara pe axul tubului si pentru a facilita aceasta operatie va sfatuim sa folositi o foarfeca speciala pentru tuburi (vezi 1495 sau 1496)

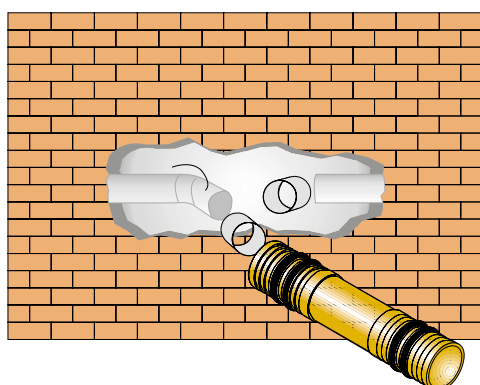

Indoiti unul din capetele tubului taiat pentru a facilita introducerea mansoanelor si a prelungitorului de reparatii (1671)

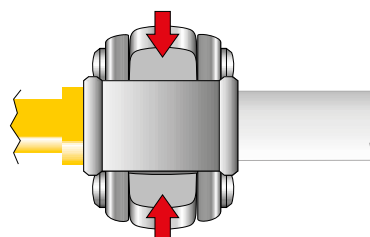
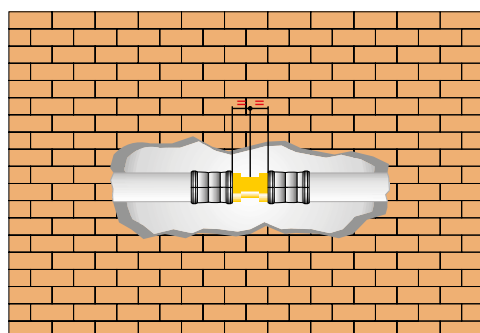

FIG. 1

Intai pozitionati mansoanele in apropierea capetelor taiate ale tubului. Odata introdus si al doilea capat al tubului de reparat pe prelungitorul de reparatii, se trece la presarea mansoanelor (vezi fig.1) tinand de partea centrala a tubului de reparatii astfel incat acesta sa fie in pozitie centrala fata de taietura executata anterior. Pentru presare folositi presa electrica.

04 RACORDURI DE COMPRESIE PENTRU TUB "COBRAPEX"

Seria 1400

Racorduri de compresie pentru tub "COBRAPEX"



96

Accesorii si piese de schimb



101



GHID DE COMPATIBILITATE

Seria	Substrat potrivit	Domeniu de aplicare	Caracteristici tehnice
1400	PE-X "COBRAPEX"	• Apa	Tmax: + 95 °C Pmax: 10 bar

Pentru detalii suplimentare consultati fisa tehnica



1400
Racord drept M

Cod	Dimensiune	Grosime	Pret €	Ambalare
140 0226	16 x 3/8"	2,0		10/250
140 0002	16 x 1/2"	2,0		10/250
140 0068	16 x 3/4"	2,0		5/150
140 0035	20 x 1/2"	2,0		5/150
140 0014	20 x 3/4"	2,0		5/150
140 0025	25 x 3/4"	2,3		5/100
140 0047	25 x 1"	2,3		5/100
140 0140	32 x 3/4"	2,9 și 3,0		5/50
140 0012	32 x 1"	2,9 și 3,0		5/50
140 0133	32 x 1"1/4	2,9 și 3,0		5/50

Până la terminarea stocului



1450
Racord drept M pentru tub
Pe-X cu garnitura o-ring pentru
colectoare bara

Cod	Dimensiune	Pret €	Ambalare
140 0239	16 x 2,0		10/250
140 0248	20 x 2,0		5/150



1402
Racord drept F

Cod	Dimensiune	Grosime	Pret €	Ambalare
140 0009	16 x 1/2"	2,0		10/200
140 0109	16 x 3/4"	2,0		5/150
140 0053	20 x 1/2"	2,0		10/150
140 0056	20 x 3/4"	2,0		5/100
140 0073	25 x 3/4"	2,3		5/100
140 0147	25 x 1"	2,3		5/100
140 0209	32 x 3/4"	2,9 și 3,0		1/60
140 0042	32 x 1"	2,9 și 3,0		5/50

Până la terminarea stocului



1401
Racord drept dublu

Cod	Dimensiune	Grosime	Pret €	Ambalare
140 0015	16 x 16	2,0		10/200
140 0043	20 x 20	2,0		5/100
140 0101	25 x 25	2,3		5/100
140 0051	32 x 32	2,9 și 3,0		5/35



1404
Cot M

Cod	Dimensiune	Grosime	Pret €	Ambalare
140 0026	16 x 1/2"	2,0		10/200
140 0124	16 x 3/4"	2,0		5/150
140 0110	20 x 1/2"	2,0		10/100
140 0059	20 x 3/4"	2,0		5/100
140 0062	25 x 3/4"	2,3		5/100
140 0093	25 x 1"	2,3		5/100
140 0098	32 x 1"	2,9 și 3,0		5/35
140 0128	32 x 1"1/4	2,9 și 3,0		5/35





1405
Cot F

Cod	Dimensiune	Grosime	Pret €	Ambalare
140 0006	16 x 1/2"	2,0		10/150
140 0154	16 x 3/4"	2,0		5/100
140 0088	20 x 1/2"	2,0		5/100
140 0060	20 x 3/4"	2,0		5/100
140 0113	25 x 3/4"	2,3		5/50
140 0181	25 x 1"	2,3		5/50
140 0142	32 x 1"	2,9 și 3,0		5/35



1406
Cot F cu flansa cu 3 gauri

Cod	Dimensiune	Grosime	Pret €	Ambalare
140 0023	16 x 1/2"	2,0		10/100



1403
Cot dublu

Cod	Dimensiune	Grosime	Pret €	Ambalare
140 0021	16 x 16	2,0		10/150
140 0079	20 x 20	2,0		5/100
140 0143	25 x 25	2,3		5/50
140 0116	32 x 32	2,9 și 3,0		5/25



1408
Teu M

Cod	Dimensiune	Grosime	Pret €	Ambalare
140 0122	16 x 1/2" x 16	2,0		10/100
140 0203	20 x 3/4" x 20	2,0		5/60
140 0260	25 x 1" x 25	2,3		5/50
140 0193	32 x 1" x 32	2,9 și 3,0		5/20

Până la terminarea stocului



1409
Teu F

Cod	Dimensiune	Grosime	Pret €	Ambalare
140 0020	16 x 1/2" x 16	2,0		10/100
140 0130	20 x 1/2" x 20	2,0		5/50
140 0127	20 x 3/4" x 20	2,0		5/50
140 0152	25 x 3/4" x 25	2,3		5/50
140 0222	32 x 3/4" x 32	2,9 și 3,0		5/20
140 0107	32 x 1" x 32	2,9 și 3,0		5/20



1407
Teu

Cod	Dimensiune	Grosime	Pret €	Ambalare
140 0007	16 x 16 x 16	2,0		10/100
140 0075	20 x 20 x 20	2,0		5/50
140 0145	25 x 25 x 25	2,3		5/35
140 0111	32 x 32 x 32	2,9 și 3,0		5/15

**1428MP**

Cot 105° F

Interaxa gauri 34mm

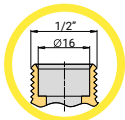

Cod	Dimensiune	Grosime	Pret €	Ambalare
140 0126	1/2" (Ø16)	toate		10/100
140 0001	16 x 1/2"	2,0		10/100
140 0032	20 x 1/2"	2,0		5/100

Racord fara garnitura

**1428XL**

Cot 105° F lung

Cod	Dimensiune	Grosime	Pret €	Ambalare
140 0087	16 x 1/2"	2,0		10/100

1428XL

GHID DE CONEXIUNI

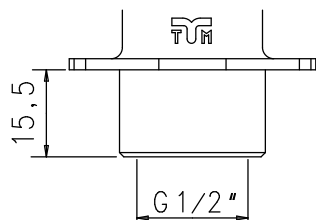
**1428MP**

GHID DE CONEXIUNI

(COD. 140 0126)

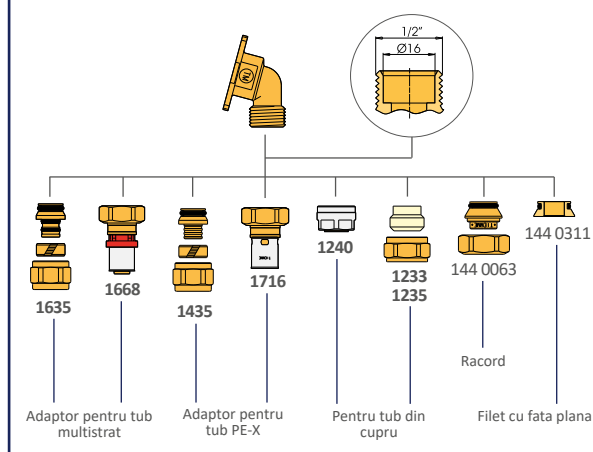

LISTA DE PREȚURI

**1490**

Caseta din plastic de utilizat cu 1418 si 1428MP

i înălțime cutie 55 mm

Cod	Dimensiune	Pret €	Ambalare
147 0003	Teaca Ø 23 si Ø 27		1/90

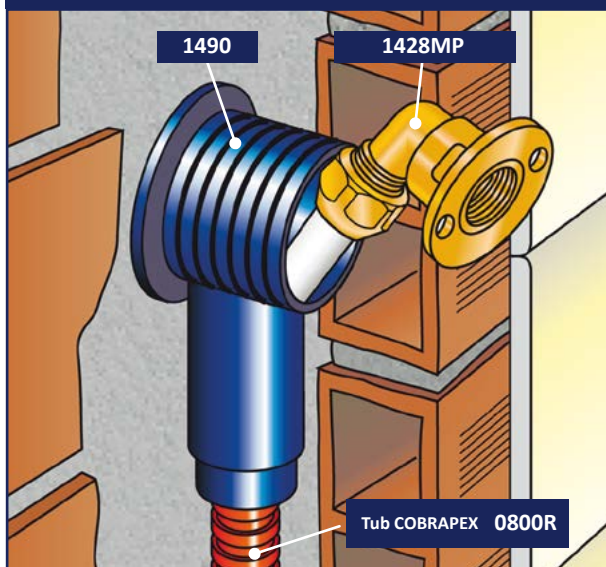
1428MP - 1490 EXEMPLU DE APLICATIE**1490P43**

Caseta din plastic compartimentabila de utilizat cu 1428MP

i înălțime cutie 59 mm

Cod	Dimensiune	Pret €	Ambalare
147 0008	teaca Ø23		1/100
147 0001	Ø27		1/100

**1492MP**

Caseta din plastic pentru pereti subtiri de utilizat cu 1428MP

i înălțime cutie 46 mm

Cod	Dimensiune	Pret €	Ambalare
147 0002	Teaca Ø 23		1/100

**1491**

Placa dubla fractionabila

Cod	Dimensiune	Pret €	Ambalare
147 0004	Unica		1/150

**1420K**

Teu F cu racord 24x19fil (Ø18) de utilizat cu 1420P

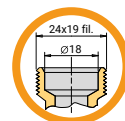

Cod	Dimensiune	Pret €	Ambalare
140 0190	24x19 fil (Ø 18) - 1/2" F		10/100

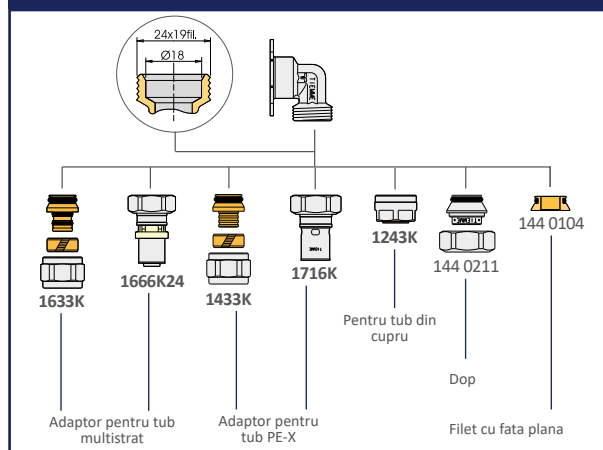
1420K GHID DE CONEXIUNI

**1420K (PEX)**

Teu F cu racord pentru teava Pex de utilizat cu 1420P

Cod	Dimensiune	Pret €	Ambalare
140 0144	16 x 2,0 - 1/2" F		10/100

1420K(PEX)

GHID DE CONEXIUNI

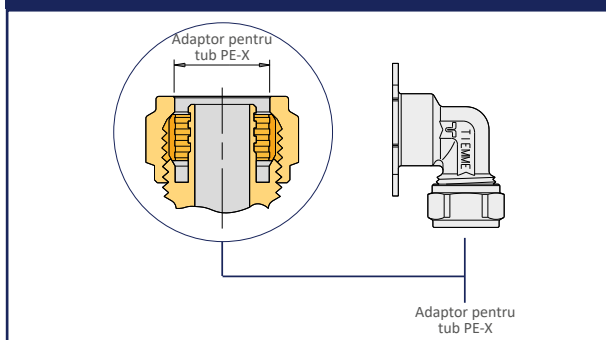
**1420P**

Doza de plastic pentru art. 1420K

Cod	Dimensiune	Pret €	Ambalare
147 0006	Teaca \varnothing 23 și \varnothing 27		1/50

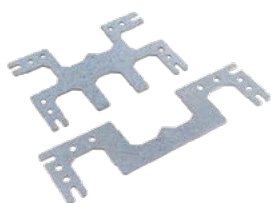
**1420Z**

Suport dublu pentru fixare 1420P

Cod	Interaxe	Pret €	Ambalare
147 0009	38 - 50 - 100		5/50
147 0007	38 - 150		5/50

**1505C04**

Tub de cupru cromat pentru legatura calorifere/alte elemente radiante

Cod	Dimensiune	Pret €	Ambalare
337 0001	\varnothing 15 x 1/2" L=150 mm		2/60

**1420K
1420K (PEX)**

EXEMPLU DE UTILIZARE

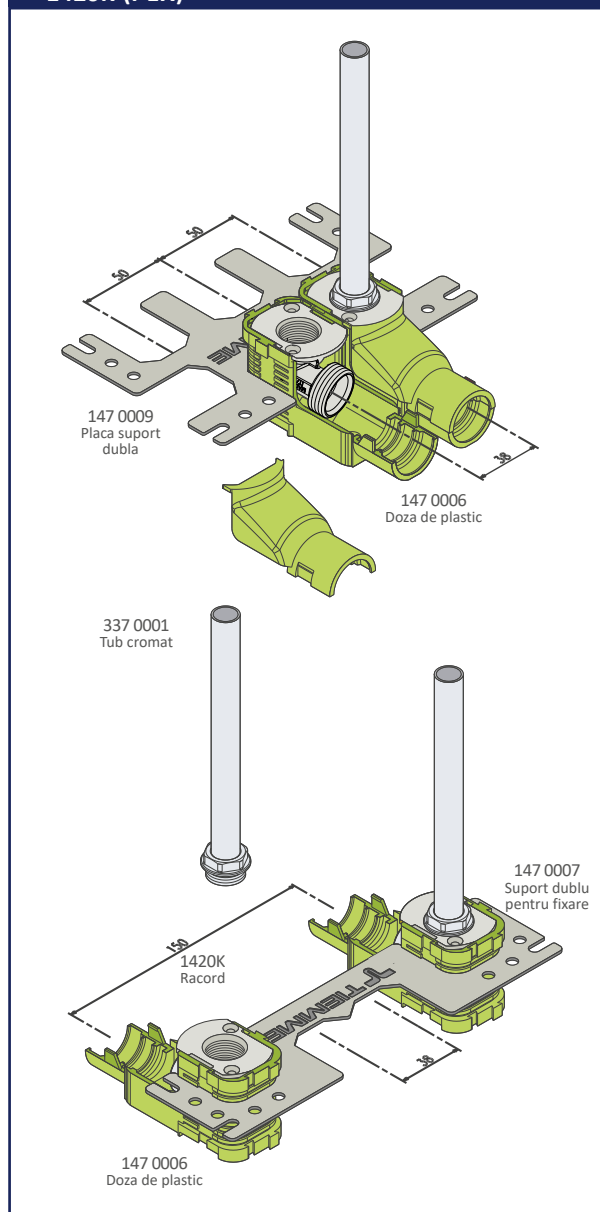

**1481**

Placa pentru cot cu flansa

1406

Cod	Dimensiune	Pret €	Ambalare
147 0005	unica		1/100

**1415**

Piulita

Cod	Dimensiune	Pret €	Ambalare
140 0212	16		50/700
140 0253	20		50/400
140 0257	25		10/200
140 0288	32		10/200

**1416**

Inel de compresie

Cod	Dimensiune	Pret €	Ambalare
140 0159	16		50/2300
140 0204	20		50/1200
140 0225	25		50/800
140 0220	32		10/400

INSTRUCIUNI PENTRU UN MONTAJ CORECT - SERIA 1400

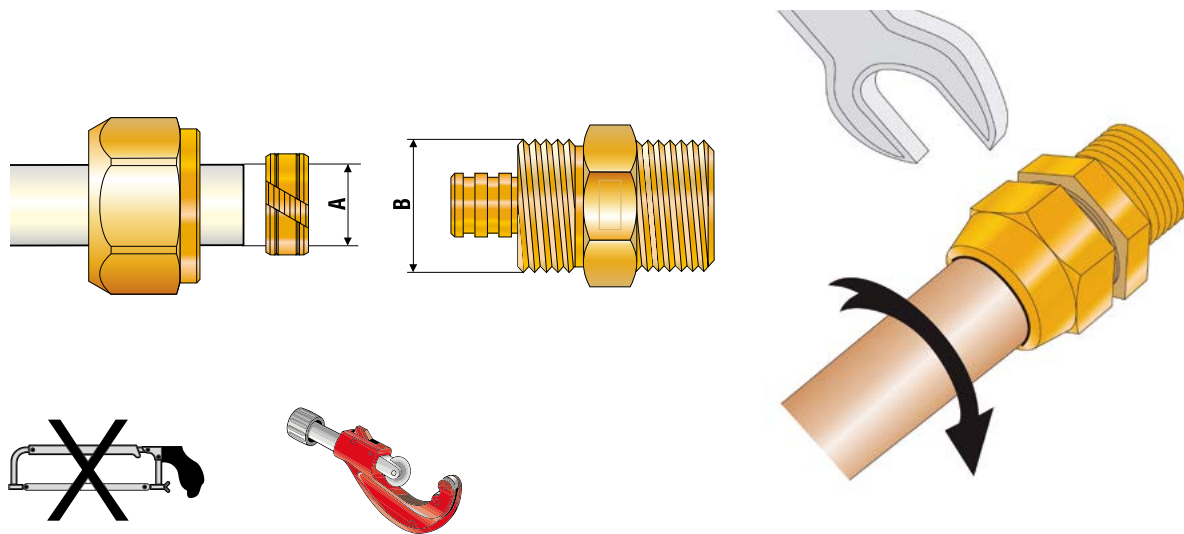
**TAIEREA TUBULUI**

Taierea tevii Pex se realizeaza cu instrumente speciale, care permit o tăiere fără bavuri și perfect perpendicular pe axa țevii.

DEBAVURAREA SI CURATAREA TEVII

Se debavureaza bine teava si se curata pentru eliminarea eventualelor reziduuri.

MONTAJUL RACORDULUI

Se monteaza piulita si inelul pe teava si apoi se introduce teava in mansonul racordului. Se insurubeaza la mana adaptorul si apoi in functie dimensiunea tevii Pex se strange cu cheia conform indicatiilor din tabel.

TABEL FILETE PIULITE

A	16	20	25	32
B	G 1/2"	G 3/4"	M32 x 1,5	M42 x 1,5

TABEL DE STRANGERE PIULITE nr ture

A	16	20	25	32
Nr. ture	1	1	1	1

05 RACORDURI DE PRESARE PENTRU TUB PEX "COBRAPEX"

Seria 1700

Racorduri de presare pentru tub PEX "COBRAPEX"		104
Robineti de presare pentru tub PEX "COBRAPEX"		112
Accesorii si piese de schimb		113
Unelte		114



GHID DE COMPATIBILITATE

Seria	Substrat potrivit	Domeniu de aplicare	Caracteristici tehnice
1700	PE-X "COBRAPEX"	• Apa	Tmax: + 95 °C Pmax: 10 bar

Pentru detalii suplimentare consultati fisa tehnica

**1700**

Racord drept M

Cod	Dimensiune	Grosime	Pret €	Ambalare
170 0281	12 x 3/8"	1,1		10/100
170 0282	12 x 1/2"	1,1		10/100
170 0283	16 x 3/8"	1,5		10/100
170 0124	16 x 1/2"	1,5		10/100
170 0285	16 x 3/4"	1,5		10/100
170 0047	16 x 1/2"	1,8		10/100
170 0091	16 x 3/4"	1,8		10/100
170 0053	16 x 1/2"	2,0		10/100
170 0125	16 x 3/4"	2,0		10/100
170 0351	17 x 1/2"	2,0		10/100
170 0024	20 x 1/2"	1,9 și 2,0		10/100
170 0065	20 x 3/4"	1,9 și 2,0		10/100
170 0327	25 x 1/2"	2,3		10/50
170 0037	25 x 3/4"	2,3		10/50
170 0046	25 x 1"	2,3		5/25
170 0041	32 x 1"	2,9 și 3,0		5/25
170 0263	40 x 1"1/4	3,7		5/25
170 0264	50 x 1"1/2	4,6		1/16
170 0265	63 x 2"	5,8		1/16

La cerere

**1702**

Racord drept F

Cod	Dimensiune	Grosime	Pret €	Ambalare
170 0290	12 x 1/2"	1,1		10/100
170 0291	16 x 1/2"	1,5		10/100
170 0292	16 x 3/4"	1,5		10/100
170 0043	16 x 1/2"	1,8		10/100
170 0100	16 x 1/2"	2,0		10/100
170 0350	17 x 1/2"	2,0		10/100
170 0035	20 x 1/2"	1,9 și 2,0		10/100
170 0059	20 x 3/4"	1,9 și 2,0		10/100
170 0328	25 x 1/2"	2,3		5/25
170 0062	25 x 3/4"	2,3		5/25

1702 - Racord drept F

Cod	Dimensiune	Grosime	Pret €	Ambalare
170 0067	25 x 1"	2,3		5/25
170 0064	32 x 1"	2,9 și 3,0		5/25
170 0268	40 x 1"1/4	3,7		5/25
170 0269	50 x 1"1/2	4,6		1/16

La cerere

**1715**

Racord drept cu piulita si garnitura plata

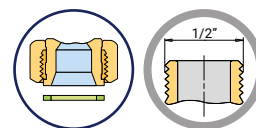

Cod	Dimensiune	Grosime	Pret €	Ambalare
170 0317	12 x 3/8"	1,1		10/100
170 0318	12 x 1/2"	1,1		10/100
170 0319	16 x 3/8"	1,5		10/100
170 0135	16 x 1/2"	1,5		10/100
170 0320	16 x 3/4"	1,5		10/100
170 0085	16 x 1/2"	1,8		10/100
170 0094	16 x 3/4"	1,8		10/100
170 0121	16 x 24 (19 fil)	1,8		10/100
170 0110	16 x 1/2"	2,0		10/100
170 0116	16 x 3/4"	2,0		10/100
170 0136	16 x 24 (19 fil)	2,0		10/100
170 0032	20 x 1/2"	1,9 și 2,0		10/100
170 0039	20 x 3/4"	1,9 și 2,0		10/100
170 0119	20 x 24 (19 fil)	1,9 și 2,0		10/100
170 0070	25 x 3/4"	2,3		2/100
170 0058	25 x 1"	2,3		2/100
170 0068	32 x 1"	2,9 și 3,0		2/100

La cerere

**1716**

Racord drept cu piulita

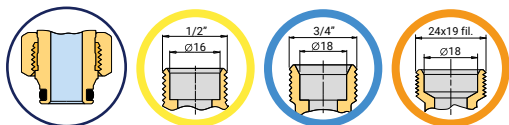

Cod	Dimensiune	Grosime	Pret €	Ambalare
170 0321	12 x 3/4" (ø18)	1,1		10/100
170 0137	16 x 3/4" (ø18)	1,5		10/100
170 0103	16 x 1/2" (ø16)	1,8		10/100
170 0090	16 x 3/4" (ø18)	1,8		10/100
170 0118	16 x 24 x 19 fil (ø18)	1,8		10/100
170 0082	16 x 1/2" (ø16)	2,0		10/100
170 0086	16 x 3/4" (ø18)	2,0		10/100
170 0057	16 x 24 x 19 fil (ø18)	2,0		10/100
170 0352	17 x 3/4" (ø18)	2,0		10/100
170 0138	18 x 24 x 19 fil (ø18)	2,0		10/100
170 0093	20 x 1/2" (ø16)	1,9 și 2,0		10/100
170 0089	20 x 3/4" (ø18)	1,9 și 2,0		10/100
170 0095	20 x 24 x 19 fil (ø18)	1,9 și 2,0		10/100
170 0081	25 x 3/4" (ø18)	2,3		2/100

La cerere

**1701**

Racord drept dublu

Cod	Dimensiune	Grosime	Pret €	Ambalare
170 0286	12 x 12	1,1		10/100
170 0126	16 x 16	1,5		10/100
170 0040	16 x 16	1,8		10/100
170 0079	16 x 16	2,0		10/100
170 0353	17 x 17	2,0		10/100
170 0020	20 x 20	1,9 și 2,0		10/100
170 0013	25 x 25	2,3		5/50
170 0018	32 x 32	2,9 și 3,0		5/25
170 0266	40 x 40	3,7		5/25
170 0260	50 x 50	4,6		1/16
170 0267	63 x 63	5,8		1/16

**1701R**

Racord drept dublu redus

Cod	Dimensiune	Grosime	Pret €	Ambalare
170 0288	16 x 12	1,5 - 1,1		10/100
170 0289	20 x 16	1,9 și 2,0 - 1,5		10/100
170 0042	20 x 16	1,9 și 2,0 - 1,8		10/100
170 0092	20 x 16	1,9 și 2,0 - 2,0		10/100
170 0061	25 x 16	2,3 - 1,8		10/100
170 0098	25 x 16	2,3 - 2,0		10/100
170 0026	25 x 20	2,3 - 1,9 și 2,0		10/100
170 0028	32 x 25	2,9 și 3,0 - 2,3		5/25
170 0364	40 x 32	3,7 - 2,9 și 3,0		5/25
170 0365	50 x 40	4,6 - 3,7		1/16
170 0366	63 x 50	5,8 - 4,6		1/16

Noutati

La cerere

**1718**

Racord de conexiune pentru țeavă Pex/țeavă din cupru prin sudură

Cod	Dimensiune	Pret €	Ambalare
170 0322	16 x 1,5 - 14		10/100
170 0323	16 x 1,5 - 16		10/100

**1704**

Cot M

Cod	Dimensiune	Grosime	Pret €	Ambalare
170 0295	12 x 3/8"	1,1		10/100
170 0296	12 x 1/2"	1,1		10/100
170 0297	16 x 1/2"	1,5		10/100
170 0074	16 x 1/2"	1,8		10/100
170 0105	16 x 1/2"	2,0		10/100
170 0038	20 x 1/2"	1,9 și 2,0		10/100
170 0332	20 x 3/4"	1,9 și 2,0		5/50
170 0044	25 x 3/4"	2,3		5/50

La cerere

**1705**

Cot F

Cod	Dimensiune	Grosime	Pret €	Ambalare
170 0298	12 x 3/8"	1,1		10/100
170 0299	12 x 1/2"	1,1		10/100
170 0127	16 x 1/2"	1,5		10/100
170 0008	16 x 1/2"	1,8		10/100
170 0054	16 x 1/2"	2,0		10/100
170 0009	20 x 1/2"	1,9 și 2,0		10/100
170 0128	20 x 3/4"	1,9 și 2,0		5/25
170 0012	25 x 3/4"	2,3		5/25
170 0030	32 x 1"	2,9 și 3,0		5/25

La cerere

**1706**

Cot F cu flansa cu 2 gauri de prindere, cu gat scurt

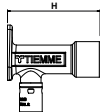

Cod	Dimensiune	Grosime	H	Pret €	Ambalare
170 0284	12 x 1/2"	1,1	40 mm		10/50
170 0129	16 x 1/2"	1,5	40 mm		10/50
170 0004	16 x 1/2"	1,8	40 mm		10/50
170 0087	16 x 1/2"	2,0	40 mm		10/50
170 0006	20 x 1/2"	1,9 și 2,0	40 mm		5/50
170 0022	25 x 3/4"	2,3	40 mm		5/25

**1710**

Racord cot cu piulita si garnitura plata

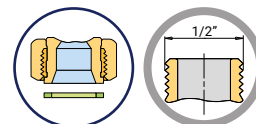

Cod	Dimensiune	Grosime	Pret €	Ambalare
170 0313	12 x 3/8"	1,1		5/100
170 0314	12 x 1/2"	1,1		5/100
170 0315	16 x 1/2"	1,5		5/100
170 0316	16 x 3/4"	1,5		5/100
170 0084	16 x 1/2"	1,8		5/100
170 0114	16 x 1/2"	2,0		5/100
170 0113	20 x 1/2"	1,9 și 2,0		5/100
170 0060	20 x 3/4"	1,9 și 2,0		5/100
170 0076	25 x 3/4"	2,3		5/50

La cerere

**1703**

Cot dublu

Cod	Dimensiune	Grosime	Pret €	Ambalare
170 0293	12 x 12	1,1		10/100
170 0294	16 x 16	1,5		10/100
170 0015	16 x 16	1,8		10/100
170 0066	16 x 16	2,0		10/100
170 0002	20 x 20	1,9 și 2,0		10/100
170 0001	25 x 25	2,3		5/25
170 0007	32 x 32	2,9 și 3,0		5/25
170 0270	40 x 40	3,7		5/25
170 0259	50 x 50	4,6		1/8
170 0271	63 x 63	5,8		1/8

**1730**

Cot cu flansa feminin de utilizat cu art. 1420P

Cod	Dimensiune	Pret €	Ambalare
170 0333	16 x 1,5 - 1/2"		10/100
170 0144	16 x 2,0 - 1/2"		10/100
170 0151	18 x 2,0 - 1/2"		10/100

Disponibil si in varianta cromata

**1420P**

Doza de plastic

Cod	Dimensiune	Pret €	Ambalare
147 0006	pentru teaca Ø 23 si Ø 27		1/50

**1420Z**

Suport dublu pentru fixare 1420P

Cod	Dimensiune	Pret €	Ambalare
147 0009	int. 38, 50 sau 100		5/50
147 0007	int. 38 sau 150		5/50

**1505C04**

Tub din cupru cromat pentru legătură elemente radiante

Cod	Dimensiune	Pret €	Ambalare
337 0001	Ø15 x 1/2" L=150 mm		2/60

**1722CY**

Tub din cupru cromat pentru legătură elemente radiante

Cod	Dimensiune	Grosime	Pret €	Ambalare
Teava de cupru Ø 15 L=160				
170 0355	17	2,0		5/50

1730 - 1420P
1420Z - 1505C04

EXEMPLU DE UTILIZARE

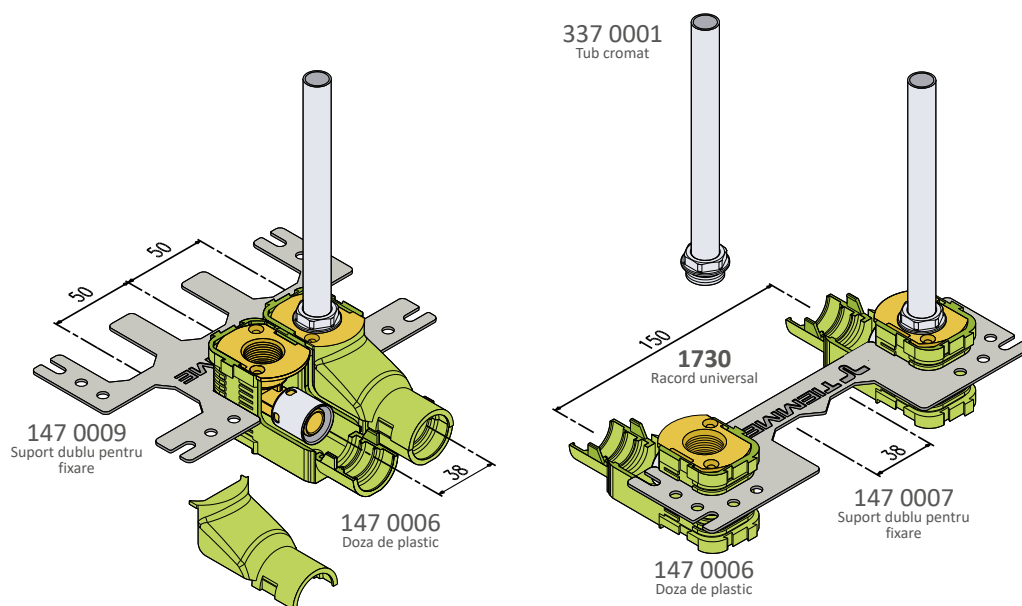

**1721U**

Cot dublu F cu flansa "U" cu gat scurt. H=40 mm

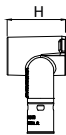

+ ANTI - LEGIONELA

Cod	Dimensiune	Grosime	H	Pret €	Ambalare
170 0339	16 x 1/2"	1,8	40 mm		5/50
170 0340	16 x 1/2"	2,0	40 mm		5/50
170 0341	20 x 1/2"	1,9 și 2,0	40 mm		5/50

**1704U**

Cot dublu M "U"

+ ANTI - LEGIONELA

Cod	Dimensiune	Grosime	Pret €	Ambalare
170 0347	16 x 1/2"	1,8		5/50
170 0348	16 x 1/2"	2,0		5/50
170 0349	20 x 1/2"	1,9 și 2,0		5/50

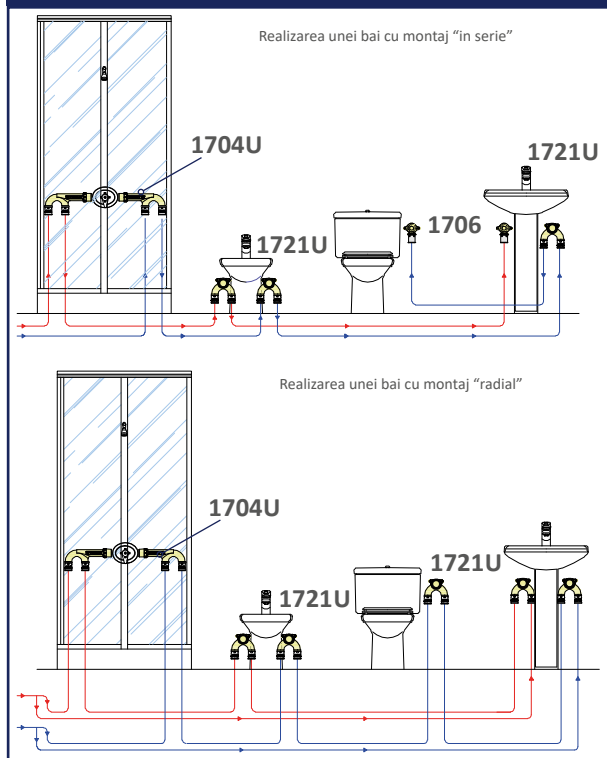
1721U - 1704U EXEMPLU DE UTILIZARE**1709**

Teu F

Cod	Dimensiune	Grosime	Pret €	Ambalare
170 0312	12 x 1/2" x 12	1,1		10/100
170 0134	16 x 1/2" x 16	1,5		10/100
170 0033	16 x 1/2" x 16	1,8		10/100
170 0104	16 x 1/2" x 16	2,0		10/100
170 0023	20 x 1/2" x 20	1,9 și 2,0		5/50
170 0025	25 x 3/4" x 25	2,3		5/25
170 0071	32 x 1" x 32	2,9 și 3,0		5/25

La cerere

**1707**

Teu

Cod	Dimensiune	Grosime	Pret €	Ambalare
170 0287	12 x 12 x 12	1,1		10/50
170 0300	16 x 16 x 16	1,5		10/50
170 0021	16 x 16 x 16	1,8		10/50
170 0073	16 x 16 x 16	2,0		10/50
170 0005	20 x 20 x 20	1,9 și 2,0		5/50
170 0011	25 x 25 x 25	2,3		5/25
170 0029	32 x 32 x 32	2,9 și 3,0		5/25
170 0275	40 x 40 x 40	3,7		1/20
170 0276	50 x 50 x 50	4,6		1/10
170 0277	63 x 63 x 63	5,8		1/5

**1707R**

Teu redus

Cod	Dimensiune 1 2 3	Grosime	Pret €	Ambalare
170 0301	16 x 12 x 12	1,5-1,1-1,1		10/50
170 0302	16 x 12 x 16	1,5-1,1-1,5		10/50
170 0303	16 x 16 x 12	1,5-1,5-1,1		10/50
170 0304	16 x 20 x 16	1,5-1,9 și 2,0-1,5		5/50
170 0072	16 x 20 x 16	1,8-1,9 și 2,0-1,8		5/50
170 0106	16 x 20 x 16	2,0-1,9 și 2,0-2,0		5/50
170 0080	16 x 25 x 16	1,8-2,3-1,8		5/25
170 0130	16 x 25 x 16	2,0-2,3-2,0		5/25



LISTA DE PREȚURI

1707 - Teu redus

Cod	Dimensiune			Grosime	Pret €	Ambalare
	1	2	3			
170 0306	20 x 12 x 16			1,9 și 2,0-1,1-1,5		5/50
170 0307	20 x 12 x 20			1,9 și 2,0-1,1-1,9 și 2,0		5/50
170 0308	20 x 16 x 16			1,9 și 2,0-1,5-1,5		5/50
170 0017	20 x 16 x 16			1,9 și 2,0-1,8-1,8		5/50
170 0101	20 x 16 x 16			1,9 și 2,0-2,0-2,0		5/50
170 0309	20 x 16 x 20			1,9 și 2,0-1,5-1,9 și 2,0		5/50
170 0003	20 x 16 x 20			1,9 și 2,0-1,8-1,9 și 2,0		5/50
170 0102	20 x 16 x 20			1,9 și 2,0-2,0-1,9 și 2,0		5/50
170 0310	20 x 20 x 16			1,9 și 2,0-1,9 și 2,0-1,5		5/50
170 0019	20 x 20 x 16			1,9 și 2,0-1,9 și 2,0-1,8		5/50
170 0107	20 x 20 x 16			1,9 și 2,0-1,9 și 2,0-2,0		5/50
170 0050	20 x 25 x 20			1,9 și 2,0-2,3-1,9 și 2,0		5/25
170 0051	25 x 16 x 16			2,3-1,8-1,8		5/25
170 0131	25 x 16 x 16			2,3-2,0-2,0		5/25
170 0031	25 x 16 x 20			2,3-1,8-1,9 și 2,0		5/25
170 0132	25 x 16 x 20			2,3-2,0-1,9 și 2,0		5/25
170 0016	25 x 16 x 25			2,3-1,8-2,3		5/25
170 0099	25 x 16 x 25			2,3-2,0-2,3		5/25
170 0056	25 x 20 x 16			2,3-1,9 și 2,0-1,8		5/25
170 0133	25 x 20 x 16			2,3-1,9 și 2,0-2,0		5/25
170 0014	25 x 20 x 20			2,3-1,9 și 2,0-1,9 și 2,0		5/25
170 0010	25 x 20 x 25			2,3-1,9 și 2,0-2,3		5/25
170 0052	25 x 25 x 16			2,3-2,3-1,8		5/25
170 0088	25 x 25 x 16			2,3-2,3-2,0		5/25
170 0027	25 x 25 x 20			2,3-2,3-1,9 și 2,0		5/25
170 0077	25 x 32 x 25			2,3-2,9 și 3,0-2,3		5/25
170 0069	32 x 25 x 25			2,9 și 3,0-2,3-2,3		5/25
170 0372	32 x 20 x 32			2,9-3,0-4,9 și 2,0-2,9 și 3,0		5/25
170 0048	32 x 25 x 32			2,9 și 3,0-2,3-2,9 și 3,0		5/25
170 0083	32 x 32 x 25			2,9 și 3,0-2,9 și 3,0-2,3		5/25
170 0370	40 x 20 x 40			3,7 - 1,9 și 2,0 - 3,7		1/20
170 0371	40 x 25 x 32			3,7 - 2,3 - 2,9 și 3,0		1/20
170 0356	40 x 25 x 40			3,7 - 2,3 - 3,7		1/20
170 0368	40 x 32 x 32			3,7 - 2,9 și 3,0-2,9 și 3,0		1/20
170 0367	40 x 40 x 32			3,7-3,7-2,9 și 3,0		1/20
170 0357	50 x 25 x 50			4,6 - 2,3 - 4,6		1/10
170 0358	50 x 40 x 40			4,6 - 3,7 - 3,7		1/10
170 0359	50 x 40 x 50			4,6 - 3,7 - 4,6		1/10
170 0360	50 x 50 x 32			4,6 - 4,6 - 2,9 și 3,0		1/10
170 0361	63 x 25 x 63			5,8 - 2,3 - 5,8		1/5
170 0362	63 x 40 x 63			5,8 - 3,7 - 5,8		1/5
170 0363	63 x 50 x 63			5,8 - 4,6 - 5,8		1/5

Racordurile Ø 20 pot fi utilizate pentru tevi cu grosimea 1,9 și 2,0

Racordurile Ø 32 pot fi utilizate pentru tevi cu grosimea 2,9 și 3,0

Noutati

La cerere

**1719CG**

Consola cu racorduri 105° finale pentru peretii din ghips sp. 13 mm

BREVETAT

Interax: 150 mm

Cod	Dimensiune	Grosime	Pret €	Ambalare
170 0331	16 x 1/2"	1,5		1/5

NOUȚĂȚI

**1719CGXL**

Consola cu racorduri 105° finale pentru peretii din ghips sp. 20 mm

BREVETAT

Interax: 150 mm

Cod	Dimensiune	Grosime	Pret €	Ambalare
170 0334	16 x 1/2"	1,8		1/5
170 0330	16 x 1/2"	2,0		1/5
170 0337	20 x 1/2"	1,9 și 2,0		1/5

La cerere

NOUȚĂȚI

**1702CG**

Consola cu racorduri drepte finale pentru peretii din ghips

BREVETAT

Interax: 150 mm

Cod	Dimensiune	Grosime	Pret €	Ambalare
170 0369	16 x 1/2"	1,5		1/5

1719CG - 1702CG - 1719CGXL

INSTRUCȚIUNI DE MONTAJ





1735
Cruce

Cod	Dimensiune	Grosime	Pret €	Ambalare
170 0055	20 x 20 x 16 x 16	1,9 și 2,0 - 1,9 și 2,0 - 1,8 - 1,8		5/25
170 0146	20 x 20 x 16 x 16	1,9 și 2,0 - 1,9 și 2,0 - 2,0 - 2,0		5/25
170 0111	20 x 16 x 20 x 16	1,9 și 2,0 - 1,8 - 1,9 și 2,0 - 1,8		5/25
170 0145	20 x 16 x 20 x 16	1,9 și 2,0 - 2,0 - 1,9 și 2,0 - 2,0		5/25
170 0109	20 x 20 x 20 x 20	1,9 și 2,0 - 1,9 și 2,0 - 1,9 și 2,0 - 1,9 și 2,0		5/25
170 0036	25 x 20 x 16 x 16	2,3 - 1,9 și 2,0 - 1,8 - 1,8		5/20
170 0148	25 x 20 x 16 x 16	2,3 - 1,9 și 2,0 - 2,0 - 2,0		5/20
170 0108	25 x 20 x 20 x 20	2,3 - 1,9 și 2,0 - 1,9 și 2,0 - 1,9 și 2,0		5/20
170 0097	25 x 16 x 20 x 16	2,3 - 1,8 - 1,9 și 2,0 - 1,8		5/20
170 0147	25 x 16 x 20 x 16	2,3 - 2,0 - 1,9 și 2,0 - 2,0		5/20

Racordurile Ø 20 pot fi utilizate pentru tevi cu grosimea 1,9 și 2,0



1736
Colector 5 cai

Cod	Dimensiune					Grosime	Pret €	Ambalare
	1	2	3	4	5			
170 0049	20	20	16	16	16	1,9 și 2,0 - 1,9 și 2,0-1,8-1,8-1,8		5/20
170 0149	20	20	16	16	16	1,9 și 2,0 - 1,9 și 2,0-2,0-2,0-2,0		5/20
170 0096	20	20	20	20	20	1,9 și 2,0 - 1,9 și 2,0-1,9 și 2,0-1,9 și 2,0-1,9 și 2,0		5/20
170 0034	25	20	16	16	16	2,3 - 1,9 și 2,0-1,8-1,8-1,8		5/20
170 0150	25	20	16	16	16	2,3 - 1,9 și 2,0-2,0-2,0-2,0		5/20
170 0112	25	20	20	20	20	2,3 - 1,9 și 2,0-1,9 și 2,0-1,9 și 2,0-1,9 și 2,0		5/20

Racordurile Ø 20 pot fi utilizate pentru tevi cu grosimea 1,9 și 2,0

**1740**

Robinet cu sfera de incastrat



Cod	Dimensiune	Grosime	Pret €	Ambalare
174 0005	16 x 16	1,8		5/50
174 0010	16 x 16	2,0		5/50
174 0002	20 x 20	1,9 și 2,0		5/50
174 0003	25 x 25	2,3		5/50

**1740U**

Robinet cu sfera de incastrat in forma de U



Cod	Dimensiune	Grosime	Pret €	Ambalare
174 0007	16 x 16	1,8		1/25
174 0011	16 x 16	2,0		1/25
174 0001	20 x 20	1,9 și 2,0		1/25
174 0004	25 x 25	2,3		1/25

**1746**

Robinet cu obertein de incastrat 2 cai



Cod	Dimensiune	Grosime	Pret €	Ambalare
174 0008	16 x 16	1,8		5/50
174 0009	16 x 16	2,0		5/50
174 0006	20 x 20	1,9 și 2,0		5/50

1740 - 1740U
1746

CONFIGURATII

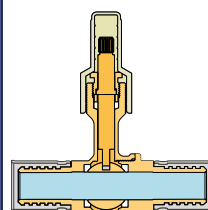

1740

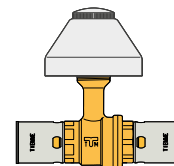
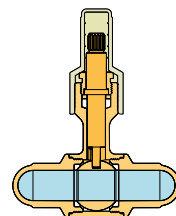
cu
2960SET

1740U

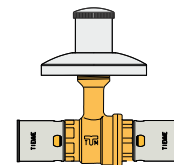
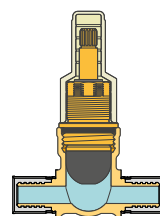
cu
2971SET

1746

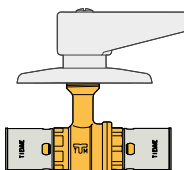
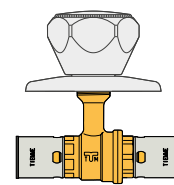
cu
2961SETcu
2963SET

**2960SET**

Set format din capac si rozeta pentru robinetii de incastat Art. 2960, 1690, 1690U, 1696, 1740, 1740U si 1746

Cod	Dimensiune	Pret €	Ambalare
295 0006	-		1/25

**2971SET**

Set format din capac si rozeta pentru robinetii de incastat Art. 2960, 1690, 1690U, 1696, 1740, 1740U si 1746

Cod	Dimensiune	Pret €	Ambalare
295 0167	-		1/25

**2963SET**

Set maneta si rozeta decorativa pentru robinetii de incastat Art. 2960, 1690, 1690U, 1696, 1740, 1740U si 1746

Cod	Dimensiune	Pret €	Ambalare
295 0014	-		1/25

**2961SET**

Set maneta si rozeta decorativa pentru robinetii de incastat Art. 2960, 1690, 1690U, 1696, 1740, 1740U si 1746

Cod	Dimensiune	Pret €	Ambalare
295 0009	-		1/25

**2960PR**

Set de prelungire pentru robinet Art. 2960, 1690, 1690U, 1696, 1740, 1740U si 1746

Cod	Dimensiune	Pret €	Ambalare
295 0015	-		1/100

**1481**

Suport pentru cot cu flansa Pentru 1706

Cod	Dimensiune	Pret €	Ambalare
147 0005	unica		1/100

**1720X**

Manson din Inox

Cod	Dimensiune	Grosime	Pret €	Ambalare
170 0336	16	1,5		10/350
170 0123	16	1,8		10/350
170 0117	16	2,0		10/350
170 0354	17	2,0		10/350
170 0152	18	2,0		10/350
170 0115	20	1,9 și 2,0		10/300
170 0122	25	2,3		10/200
170 0120	32	2,9 și 3,0		10/150

La cerere

**1670B**

Manson din Inox

Cod	Dimensiune	Grosime	Pret €	Ambalare
170 0324	40	3,7		10/100
170 0325	50	4,6		1/50
170 0326	63	5,8		1/30



1681RF

Capete de presare - RF profile - personalizat TIEMME

i Pentru accesorii vezi Cap. 8A

Cod	Dimensiune	Pret €	Ambalare
159 0095	12		1/1
159 0038	16		1/1
159 0129	17		1/1
159 0051	18		1/1
159 0039	20		1/1
159 0040	25		1/1
159 0042	32		1/1



1681MINIRF

Capete de presare - RF profile - personalizat TIEMME pentru presa MINI

i Pentru accesorii vezi Cap. 8A

Cod	Dimensiune	Pret €	Ambalare
159 0094	12		1/1
159 0032	16		1/1
159 0130	17		1/1
159 0052	18		1/1
159 0029	20		1/1
159 0033	25		1/1
159 0035	32		1/1



1681

Capete de presare - TH PROFILE - personalizat TIEMME

i Pentru accesorii vezi Cap. 8A

Cod	Dimensiune	Pret €	Ambalare
159 0010	40		1/1
159 0008	50		1/1
159 0012	63		1/1

Capete de presare cu 3 sectoare

DIMENSIUNI DE GABARIT PENTRU CAPETELE DE PRESARE

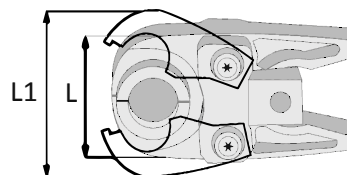

Cod	Dimensiune	L (mm)	L1 (mm)
159 0095	12	101	104
159 0038	16	101	104
159 0129	17	101	104
159 0051	18	101	104
159 0039	20	101	104
159 0040	25	101	115
159 0042	32	101	115
159 0010	40	101	120
159 0008	50	165	175
159 0012	63	175	185
159 0094	12	101	101
159 0032	16	101	101
159 0130	17	101	101
159 0052	18	101	101
159 0029	20	101	101
159 0033	25	101	108
159 0035	32	101	108

L=falcile in pozitia inchis
L1=falcile in pozitia deschis



INSTRUCIUNI DE MONTAJ DE LA Ø12 LA Ø32

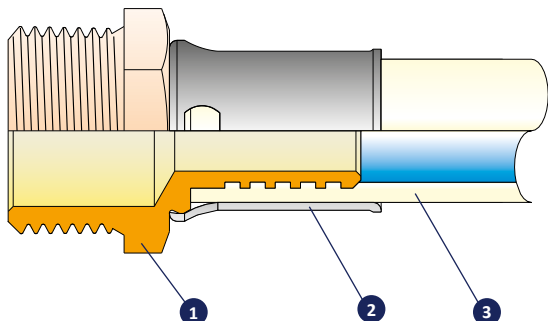

- 1 Corpul racordului din alama
- 2 Manson de sertizare din oțel inox AISI 304
- 3 Tub din polietilena reticulata "PEX"

Fitingurile de presare se caracterizează prin sistemul de etanșare care se formează prin deformarea mecanică a mansonului din oțel inoxidabil. Această deformare se realizează cu ajutorul unui instrument special echipat cu clești de oțel corespunzători; Procedând astfel, puteți fi siguri că presiunea de strângere rămâne întotdeauna aceeași și la un nivel optim pentru toate fittingurile, crescând fiabilitatea îmbinării. Fitingurile de presare Tiemme se caracterizează și prin prezența a patru ferestre cu o funcție de importanță fundamentală, ceea ce permite instalatorului să verifice vizual și ușor dacă și când țeava este introdusă corect în fitting. Aceasta posibilitate de verificare simplă și imediată garantează un montaj fiabil și rapid față de alte tipuri de fittinguri.

Pentru a obține o îmbinare perfectă trebuie efectuate câteva operații simple, dar importante.

1. TĂIEREA ȚEVII

Mai întâi trebuie să tăiați tubul la dimensiunea dorită. Pentru a efectua tăierea este indicat să folosiți un tăietor de țevi sau foarfeca adecvată, asigurându-vă că tăierea este cât mai perpendiculară pe axa țevii.

2. CONECTAREA TUBULUI LA FITING

Introduceți țeava în fitting până când ajunge la capăt (verificați prin „fereastra” mansonului).

3. PRESARE

Înainte de a trece la presarea fittingului este necesar să se verifice dacă mansonul este corect asamblat pe locul specific realizat pe fittingul din alama, dacă este necesară repositionarea mansonului. În cazul instalării cu montaj îngropat în beton lichid, sau în orice caz de montaj îngropat, se recomandă protejarea legăturilor dintre fittinguri și țeavă pentru a le izola de eventualele contacte cu masa de beton.

Vă reamintim că profilul fălcilor ce urmează a fi folosit pentru presarea fittingurilor TIEMME trebuie să fie de tip RF.

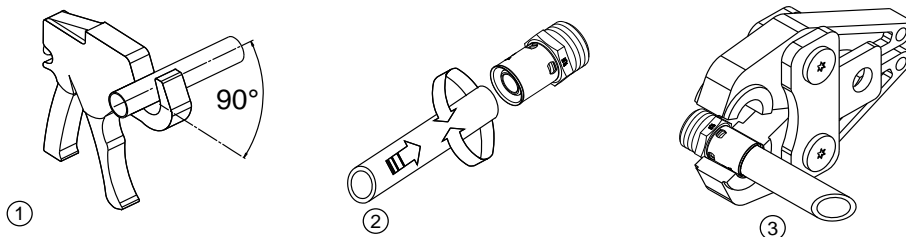

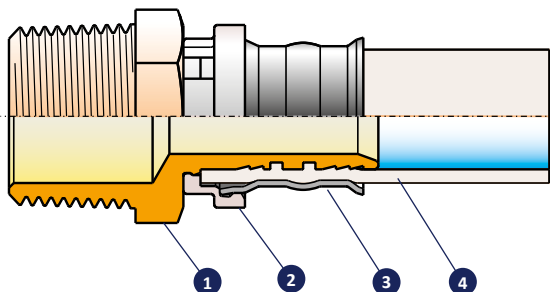
INSTRUCIUNI DE MONTAJ $\varnothing 40 - \varnothing 50 - \varnothing 63$ 

- 1 Corpul racordului din alama
- 2 Inel din plastic, permite sa se vada daca tubul a fost bine introdus in racord si izoleaza dielectric tubul fata de corpul racordului
- 3 Manson de sertizare din oțel inox AISI 304
- 4 Tub din polietilena reticulata "PEX"

Fitingurile de presare se caracterizează prin sistemul de etanșare care se formează prin deformarea mecanică a mansonului din oțel inoxidabil. Această deformare se realizează cu ajutorul unui instrument special echipat cu clești de oțel corespunzători; Procedând astfel, puteți fi siguri că presiunea de strângere rămâne întotdeauna aceeași și la un nivel optim pentru toate fittingurile, crescând fiabilitatea îmbinării. Fitingurile de presare Tiemme se caracterizează și prin prezența a patru ferestre cu o funcție de importanță fundamentală, ceea ce permite instalatorului să verifice vizual și ușor dacă și când țeava este introdusă corect în fitting. Aceasta posibilitate de verificare simplă și imediată garantează un montaj fiabil și rapid față de alte tipuri de fittinguri.

Pentru a obține o îmbinare perfectă trebuie efectuate câteva operații simple, dar importante.

1. TĂIEREA ȚEVII

Mai întâi trebuie să tăiați tubul la dimensiunea dorită. Pentru a efectua tăierea este indicat să folosiți un tăietor de țevi sau foarfeca adecvată, asigurându-vă că tăierea este cât mai perpendiculară pe axa țevii.

2. CONECTAREA TUBULUI LA FITING

Introduceți țeava în fitting până când ajunge la capăt (verificați prin „fereastra” mansonului).

3. PRESARE

Înainte de a trece la presarea fittingului este necesar să se verifice dacă mansonul este corect asamblat pe locul specific realizat pe fittingul din alama, dacă este necesară repositionarea mansonului. În cazul instalării cu montaj îngropat în beton lichid, sau în orice caz de montaj îngropat, se recomandă protejarea legăturilor dintre fittinguri și țeavă pentru a le izola de eventualul contact cu masa de beton.

Vă reamintim că profilul fălcilor ce urmează a fi folosit pentru presarea fittingurilor TIEMME trebuie să fie de tip TH.

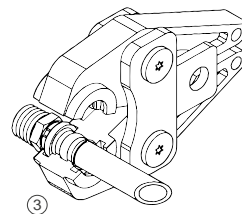
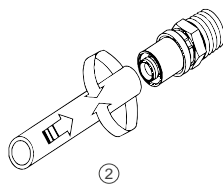
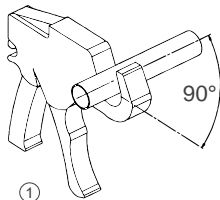

kiwa



kiwa



Seria 1000/1100

Racorduri de compresie pentru tub din cupru cu inel din alamă - seria 1000		118
Racorduri de compresie pentru tub din cupru cu inel din alamă - seria 1100		121
Accesorii		126
Piese de schimb		128

GHID DE COMPATIBILITATE

Seria	Tub potrivit	Stut de ranforsare	Domeniu de aplicare	Caracteristici tehnice
1000	Cupru	-	<ul style="list-style-type: none"> • Apa • Gaz • Instalatii solare 	Tmax: + 200 °C Pmax: 30 bar/10 bar (cu abur)
	Cupru calit	Art. 1116	<ul style="list-style-type: none"> • Apa • Gaz • Instalatii solare 	Tmax: + 200 °C Pmax: 30 bar /10 bar (cu abur)
	PE-X	Art. 1120	<ul style="list-style-type: none"> • Apa 	Tmax: + 95 °C Pmax: 10 bar
1100	Cupru	-	<ul style="list-style-type: none"> • Apa • Instalatii solare 	Tmax: + 200 °C Pmax: 30 bar /10 bar (cu abur)
	Cupru calit	Art. 1116	<ul style="list-style-type: none"> • Apa • Instalatii solare 	Tmax: + 200 °C Pmax: 30 bar /10 bar (cu abur)
	PE-X	Art. 1120	<ul style="list-style-type: none"> • Apa 	Tmax: + 95 °C Pmax: 10 bar

Pentru detalii suplimentare consultati fisa tehnica

1000
Racord drept M

i Disponibil si in varianta nichelat

Cod	Dimensiune	Pret €	Ambalare
100 0110	10 x 1/4"		10/100
100 0080	10 x 3/8"		10/100
100 0057	10 x 1/2"		10/100
100 0152	12 x 1/4"		10/100
100 0091	12 x 3/8"		10/100
100 0038	12 x 1/2"		10/100
100 0070	15 x 3/8"		10/100
100 0011	15 x 1/2"		10/100
100 0064	15 x 3/4"		5/100
100 0065	22 x 1/2"		5/100
100 0009	22 x 3/4"		5/100
100 0071	22 x 1"		5/75
100 0078	28 x 3/4"		5/75
100 0042	28 x 1"		5/50

1002
Racord drept F

i Disponibil si in varianta nichelat

Cod	Dimensiune	Pret €	Ambalare
100 0176	10 x 1/4"		10/100
100 0126	10 x 3/8"		10/100
100 0031	10 x 1/2"		10/100
100 0128	12 x 3/8"		10/100
100 0041	12 x 1/2"		10/100
100 0142	15 x 3/8"		10/100
100 0019	15 x 1/2"		10/100
100 0049	15 x 3/4"		5/100
100 0052	22 x 1/2"		5/100
100 0007	22 x 3/4"		5/100
100 0105	22 x 1"		5/75
100 0129	28 x 3/4"		5/50
100 0043	28 x 1"		5/50

1001
Racord drept dublu

i Disponibil si in varianta nichelat

Cod	Dimensiune	Pret €	Ambalare
100 0045	10 x 10		10/100
100 0047	12 x 12		10/100
100 0004	15 x 15		10/100
100 0001	22 x 22		5/75
100 0032	28 x 28		5/50
Redus			
100 0100	12 x 10		10/100
100 0106	15 x 10		10/100
100 0069	15 x 12		10/100
100 0044	22 x 15		5/100
100 0193	28 x 15		5/75
100 0089	28 x 22		5/50

1004
Cot M

i Disponibil si in varianta nichelat

Cod	Dimensiune	Pret €	Ambalare
100 0169	10 x 3/8"		10/100
100 0130	12 x 3/8"		10/100
100 0077	12 x 1/2"		10/100
100 0027	15 x 1/2"		10/100
100 0063	15 x 3/4"		5/100
100 0140	22 x 1/2"		5/100
100 0018	22 x 3/4"		5/75
100 0099	22 x 1"		5/50
100 0187	28 x 3/4"		5/50
100 0109	28 x 1"		5/50



**1005**

Cot F



i Disponibil si in varianta nichelat

Cod	Dimensiune	Pret €	Ambalare
100 0164	12 x 3/8"		10/100
100 0073	12 x 1/2"		10/100
100 0157	15 x 3/8"		10/100
100 0016	15 x 1/2"		10/100
100 0067	15 x 3/4"		5/75
100 0084	22 x 1/2"		5/100
100 0017	22 x 3/4"		5/75
100 0053	22 x 1"		5/50
100 0156	28 x 3/4"		5/50
100 0074	28 x 1"		5/25

**1003**

Cot dublu



i Disponibil si in varianta nichelat

Cod	Dimensiune	Pret €	Ambalare
100 0024	10 x 10		10/100
100 0029	12 x 12		10/100
100 0002	15 x 15		10/100
100 0003	22 x 22		5/75
100 0015	28 x 28		5/25
Redus			
100 0145	12 x 10		10/100
100 0107	15 x 12		10/100
100 0054	22 x 15		5/100
100 0148	28 x 22		5/50

**1009**

Teu F cu filet ISO7/EN 10226



i Disponibil si in varianta nichelat

Cod	Dimensiune	Pret €	Ambalare
100 0132	12 x 3/8" x 12		10/100
100 0093	12 x 1/2" x 12		10/100
100 0200	15 x 1/4" x 15		10/100
100 0023	15 x 1/2" x 15		10/100
100 0014	22 x 1/2" x 22		5/50
100 0066	22 x 3/4" x 22		5/50
100 0194	22 x 1" x 22		5/25
100 0101	28 x 1/2" x 28		5/25
100 0117	28 x 3/4" x 28		5/25
100 0127	28 x 1" x 28		5/25

**1039**

Teu lateral F



i Disponibil si in varianta nichelat

Cod	Dimensiune	Pret €	Ambalare
100 0062	15 x 15 x 1/2"		10/100
100 0022	22 x 22 x 1/2"		5/60
100 0112	22 x 22 x 3/4"		5/50

**1007**
Teu

i Disponibil si in varianta nichelat

Cod	Dimensiune			Pret €	Ambalare
	1	2	3		
100 0061	10	10	10		10/100
100 0050	12	12	12		10/100
100 0005	15	15	15		10/100
100 0013	22	22	22		5/50
100 0060	28	28	28		5/25
Redus					
100 0151	12	15	12		10/100
100 0177	15	12	12		10/100
100 0116	15	12	15		10/100
100 0185	15	15	12		10/100
100 0133	15	22	15		5/50
100 0086	22	15	15		5/50
100 0020	22	15	22		5/50
100 0056	22	22	15		5/50
100 0212	22	28	22		5/25
100 0216	28	15	22		5/25
100 0108	28	15	28		5/25
100 0174	28	22	22		5/25
100 0103	28	22	28		5/25
100 0189	28	28	15		5/25
100 0183	28	28	22		5/25

**1037**
Teu în unghi

i Disponibil si in varianta nichelat

Cod	Dimensiune	Pret €	Ambalare
100 0158	15 x 15 x 15		10/100
100 0198	22 x 15 x 15		5/50
100 0196	22 x 15 x 22		5/50

Până la terminarea stocului

**1010**
Racord cruce

i Disponibil si in varianta nichelat

Cod	Dimensiune	Pret €	Ambalare
100 0059	15 x 15 x 15 x 15		5/50
100 0082	22 x 22 x 22 x 22		5/25
Redus			
100 0217	22 x 15 x 15 x 15		5/50
100 0165	22 x 15 x 22 x 15		5/50
100 0225	22 x 22 x 15 x 15		5/50

Până la terminarea stocului

**1035**
Dop final

i Disponibil si in varianta nichelat

Cod	Dimensiune	Pret €	Ambalare
100 0150	10		10/600
100 0095	12		10/400
100 0028	15		10/350
100 0012	22		5/150
100 0098	28		5/100



LISTA DE PREȚURI



1100
Racord drept M

 Disponibil si in varianta nichelat

Cod	Dimensiune	Pret €	Ambalare
110 0124	08 x 1/4"		10/200
110 0136	08 x 3/8"		10/100
110 0019	10 x 1/2"		10/100
110 0206	14 x 3/8"		10/100
110 0072	14 x 1/2"		10/100
110 0001	15 x 1/2"		10/100
110 0023	15 x 3/4"		5/100
110 0214	16 x 3/8"		10/100
110 0044	16 x 1/2"		10/100
110 0118	16 x 3/4"		5/100
110 0009	18 x 1/2"		10/100
110 0277	18 x 1/2" ISO7		10/100
110 0011	18 x 3/4"		5/100
110 0278	18 x 3/4" ISO7		5/100
110 0279	18 x 1" ISO7		5/75
110 0034	22 x 1/2"		5/100
110 0002	22 x 3/4"		5/100
110 0017	22 x 1"		5/75
110 0008	28 x 1"		5/75
110 0100	28 x 1" 1/4		1/50
110 0082	35 x 1"		1/50
110 0022	35 x 1" 1/4		1/25
110 0069	42 x 1" 1/2		1/25
110 0053	54 x 2"		1/10



1100FD
Racord drept pentru teava de
cupru - masculin fata dreapta

Cod	Dimensiune	Pret €	Ambalare
471 0023	15 x 1/2"		10/100
471 0010	15 x 3/4"		5/100
471 0048	16 x 1/2"		10/100
471 0026	18 x 1/2"		10/100
471 0009	18 x 3/4"		5/100
471 0065	18 x 1"		5/100
471 0066	22 x 1/2"		5/100
471 0001	22 x 3/4"		5/100
471 0007	22 x 1"		5/75
471 0042	28 x 1" 1/4		1/50



1102
Racord drept F

 Disponibil si in varianta nichelat

Cod	Dimensiune	Pret €	Ambalare
110 0167	08 x 1/4"		10/100
110 0141	08 x 3/8"		10/100
110 0094	14 x 1/2"		10/100
110 0223	14 x 3/4"		5/100
110 0007	15 x 1/2"		10/100
110 0095	16 x 1/2"		10/100
110 0187	16 x 3/4"		5/100
110 0024	18 x 1/2" ISO7		10/100
110 0026	18 x 3/4"		5/100
110 0275	18 x 3/4" ISO7		5/100
110 0276	18 x 1" ISO7		5/75
110 0039	22 x 1"		5/75
110 0066	35 x 1" 1/4		1/50
110 0099	42 x 1" 1/2		1/25
110 0083	54 x 2"		1/10



1102FD
Racord drept pentru teava de
cupru - feminin fata dreapta

Cod	Dimensiune	Pret €	Ambalare
471 0054	18 x 1/2"		10/100
471 0044	22 x 1/2"		5/100
471 0062	22 x 3/4"		5/100
471 0055	22 x 1"		5/50



1140
Racord drept cu piulita

Cod	Dimensiune	Pret €	Ambalare
110 0159	15 x 3/4"		5/150

Strangere piulita libera max 1/4 ture
Utilizati garniturile furnizate



1101
Racord drept dublu

i Disponibil si in varianta nichelat

Cod	Dimensiune	Pret €	Ambalare
110 0063	08 x 08		10/100
110 0057	14 x 14		10/100
110 0116	16 x 16		10/100
110 0005	18 x 18		10/100
110 0064	35 x 35		1/25
110 0092	42 x 42		1/25
110 0061	54 x 54		1/10
Redus			
110 0105	10 x 08		10/100
110 0157	15 x 08		10/100
110 0250	16 x 15		10/100
110 0195	18 x 12		10/100
110 0046	18 x 15		10/100
110 0060	22 x 18		5/100
110 0168	35 x 28		1/50



1104
Cot M

i Disponibil si in varianta nichelat

Cod	Dimensiune	Pret €	Ambalare
110 0228	08 x 3/8"		10/100
110 0042	10 x 1/2" ISO7		10/100
110 0175	15 x 3/8" ISO7		10/100
110 0015	15 x 1/2"		10/100
110 0085	15 x 3/4"		5/75
110 0051	18 x 1/2" ISO7		10/100
110 0037	18 x 3/4" ISO7		5/75
110 0068	22 x 1/2"		5/100
110 0020	22 x 3/4"		5/75
110 0038	22 x 1"		5/50
110 0169	28 x 3/4"		5/50
110 0035	28 x 1"		5/50
110 0202	35 x 1"		1/25
110 0074	35 x 1"1/4		1/25
110 0106	42 x 1"1/2		1/25

Până la terminarea stocului



1104FD
Cot de compresie din cupru - M
cu fata plana

Cod	Dimensiune	Pret €	Ambalare
471 0021	15 x 3/4"		5/75
471 0059	16 x 3/4"		5/75
471 0006	18 x 3/4"		5/75
471 0002	22 x 3/4"		5/75
471 0032	22 x 1"		5/50



**1105**
Cot F

i Disponibil si in varianta nichelat

Cod	Dimensiune	Pret €	Ambalare
110 0152	10 x 3/8"		10/100
110 0054	10 x 1/2" ISO7		10/100
110 0111	14 x 1/2"		10/100
110 0138	16 x 1/2"		10/100
110 0041	18 x 1/2" ISO7		10/100
110 0018	18 x 3/4" ISO7		5/75
110 0109	35 x 1"1/4		1/25
110 0128	42 x 1"1/2		1/20
110 0200	54 x 2"		1/10

**1106**
Cot F cu flansa cu 3 gauri

i Disponibil si in varianta nichelat

Cod	Dimensiune	Pret €	Ambalare
110 0065	10 x 1/2"		10/100
110 0043	12 x 1/2"		10/100
110 0149	14 x 1/2"		10/100
110 0004	15 x 1/2"		10/80
110 0208	15 x 3/4"		5/50
110 0180	16 x 1/2"		10/100
110 0091	18 x 1/2"		5/50
110 0142	18 x 3/4"		5/50
110 0137	22 x 1/2"		5/50
110 0084	22 x 3/4"		5/50

**1103**
Cot dublu

i Disponibil si in varianta nichelat

Cod	Dimensiune	Pret €	Ambalare
110 0120	08 x 08		10/100
110 0156	14 x 14		10/100
110 0144	16 x 16		10/100
110 0003	18 x 18		10/100
110 0049	35 x 35		1/25
110 0078	42 x 42		1/20
Redus			
110 0079	18 x 15		10/100
110 0056	22 x 18		5/75

**1133**
Cot dublu tub din cupru/tub Pex

Cod	Dimensiune	Pret €	Ambalare
471 0103	18 (Cu)/18 sp. 2,5 (Pex)		5/100
471 0067	22 (Cu)/18 sp. 2,0 (Pex)		5/100
471 0027	22 (Cu)/18 sp. 2,5 (Pex)		5/100
471 0008	22 (Cu)/22 sp. 3,0 (Pex)		5/100

La cerere

**1141**
Cot cu piulita

Cod	Dimensiune	Pret €	Ambalare
110 0101	15 x 1/2"		10/150

Piulita de strangere max 1/2 ture

Până la terminarea stocului

Nota: A se utiliza garniturile din kit.

**1108**
Teu M

Cod	Dimensiune	Pret €	Ambalare
110 0096	15 x 1/2" x 15		10/100
110 0207	18 x 1/2" x 18		10/50
110 0067	22 x 3/4" x 22		5/50

**1109**
Teu F

 Disponibil si in varianta nichelat

Cod	Dimensiune	Pret €	Ambalare
110 0204	14 x 1/2" x 14		10/100
110 0190	16 x 1/2" x 16		10/90
110 0071	18 x 1/2" ISO7 x 18		5/50
110 0059	18 x 3/4" ISO7 x 18		5/50
110 0174	35 x 1" 1/4 x 35		1/20

**1139**
Teu F

Cod	Dimensiune	Pret €	Ambalare
110 0115	18 x 18 x 1/2"		5/70

**1107**
Teu

 Disponibil si in varianta nichelat

Cod	Dimensiune			Pret €	Ambalare
	1	2	3		
110 0139	08	08	08		10/100
110 0171	14	14	14		10/100
110 0166	16	16	16		10/80
110 0032	18	18	18		5/50
110 0093	35	35	35		1/20
110 0121	42	42	42		1/15
110 0135	54	54	54		1/7
Redus					
110 0192	18	15	15		5/75
110 0104	18	15	18		5/75
110 0216	18	18	15		5/75
110 0209	22	18	18		5/50
110 0146	22	18	22		5/50
110 0224	22	22	18		5/50
110 0237	28	35	28		1/25
110 0213	35	22	35		1/20

Până la terminarea stocului

**1138**
Teu tub din cupru/tub Pex/tub
din cupru

Cod	Dimensiune			Pret €	Ambalare
	1	2	3		
471 0037	22 (Cu)	18 x 2,5 (Pex)	22(Cu)		5/50
471 0025	22 (Cu)	22 x 3,0 (Pex)	22(Cu)		5/50

**1110**
Racord cruce

 Disponibil si in varianta nichelat

Cod	Dimensiune	Pret €	Ambalare
110 0217	18 x 18 x 18 x 18		5/50



**1142**

Racord drept dublu cu purjare
din teava de cupru/teava de
cupru

Cod	Dimensiune	Pret €	Ambalare
110 0221	15 x 15		5/90
110 0222	22 x 22		5/60
110 0242	28 x 28		5/35

Până la terminarea stocului

**1144**

Cot Pentru tub din cupru/M cu
purjare

Cod	Dimensiune	Pret €	Ambalare
110 0173	22 x 3/4"		5/60

**1143**

Cot Pentru tub din cupru/teava
din cupru cu purjare

Cod	Dimensiune	Pret €	Ambalare
110 0102	22 x 22		5/50

**1145**

Racord de prindere pentru
rezervoare

Cod	Dimensiune	Pret €	Ambalare
110 0117	15		10/130
110 0062	22		5/70
110 0113	28		5/50
110 0182	35		1/40
110 0194	42		1/25
110 0164	54		1/20

**1135**

Dop final

 Disponibil si in varianta nichelat

Cod	Dimensiune	Pret €	Ambalare
110 0140	08		10/700
110 0027	18		10/220
110 0133	35		1/50
110 0127	54		1/30

Până la terminarea stocului



1431

Adaptoare pentru tuburi PE-X cu racorduri 1/2"x15

(Set piulita galbena, inel si insertie)

Cod	Dimensiune	Pret €	Ambalare
144 0246	16 x 2,0 - Rif Ø 15		10/200



1631G

Adaptoare pentru tuburi multistrat cu racorduri 1/2"x15 (Set piulita galbena, inel si insertie)

Cod	Dimensiune	Pret €	Ambalare
144 0070	16 x 2,0 - Rif Ø 15		10/200
144 0101	16 x 2,25 - Rif Ø 15		10/200
144 0201	20 x 2,0 - Rif Ø 22		10/350
144 0222	25 x 2,5 - Rif Ø 28		10/150
144 0165	26 x 3,0 - Rif Ø 28		10/150
144 0223	32 x 3,0 - Rif Ø 35		10/100

Furnizat fara piulita
La cerere

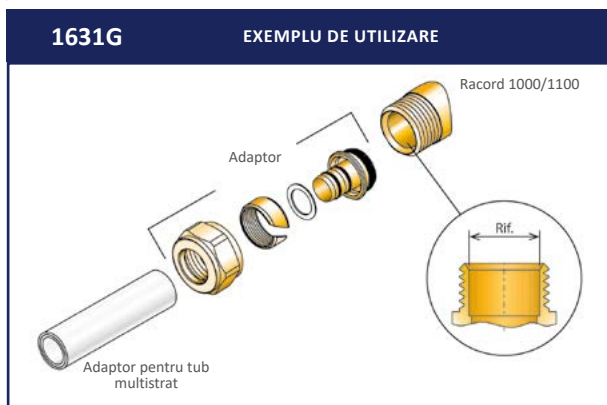

1116

Stut de ranforsare pentru tub din cupru

Cod	Dimensiune	Pret €	Ambalare
110 0227	08 x 1,0		100/3500
110 0033	10 x 1,0		100/3500
110 0028	12 x 1,0		100/2500
110 0050	14 x 1,0		100/1500
110 0014	15 x 1,0		50/1300
110 0097	16 x 1,0		100/1000
110 0240	18 x 0,8		100/800
110 0013	18 x 1,0		100/800
110 0006	22 x 1,0		50/500



1120

Stut de ranforsare pentru teava Pe-x

Cod	Dimensiune	Pret €	Ambalare
110 0123	12 x 2,0		100/2500
110 0029	15 x 2,5		100/2000
110 0126	18 x 2,5		100/1200
110 0073	22 x 3,0		50/700
110 0122	28 x 3,0		50/400
110 0197	28 x 4,0		50/400





1147
Stut reductie

Cod	Dimensiune	Pret €	Ambalare
110 0243	18 x 14		25/750
110 0025	18 x 16		25/750
110 0176	35 x 28		5/130
110 0205	42 x 28		1/120
110 0215	42 x 35		1/120
110 0210	54 x 28		1/60
110 0225	54 x 35		1/60
110 0212	54 x 42		1/60

Până la terminarea stocului



1147CZ
Reductie

Cod	Dimensiune	Pret €	Ambalare
113 0157	12 x 08		25/1300
113 0045	12 x 10		25/1300
113 0202	15 x 08		25/900
113 0062	15 x 10		25/900
113 0026	15 x 12		25/900
113 0079	18 x 12		25/750
113 0018	18 x 15		25/750
113 0083	22 x 12		25/500
113 0028	22 x 15		25/500
113 0022	22 x 18		25/500
113 0152	28 x 15		25/300
113 0067	28 x 22		10/300

1147 - 1147CZ EXEMPLU DE INSTALATIE TIPICA

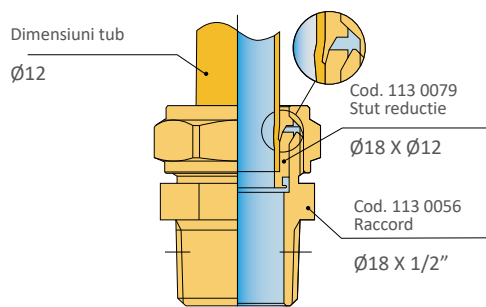

Stuturile de ranforsare 1147 sau 1147CZ sunt indicate doar pentru tevile de cupru sau pentru cele de inox calibrat; pentru orice alta aplicatie contactati biroul tehnic.

1147 - 1147CZ INSTRUCIUNI PENTRU UN MONTAJ CORECT

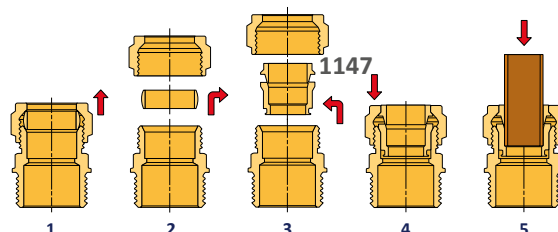

1. Racord de compresie pentru teava de cupru
2. Eliminati inelul de arama
3. Insetati mansonul de ranforsare
4. Strangeti piulita pe racord
5. Introduceti teava si strangeti

OPERATIUNI DE MONTARE PRIN STRANGERE

- Se strange cu mana cat este posibil
- Se strange cu cheia inca ¼ ture pana la pauza de pe inel.
- Se finalizeaza strangerea conform numarului de ture din tabel.

Cod	Pauza	Ture de strans	
113 0157	1/4	min. 1	max. 1 1/4
113 0045	1/4	min. 1	max. 1 1/4
113 0202	1/4	min. 1	max. 1 1/4
113 0062	1/4	min. 1	max. 1 1/4
113 0026	1/4	min. 1 1/4	max. 1 1/2
113 0079	1/4	min. 1	max. 1 1/4
113 0018	1/4	min. 1	max. 1 1/4
113 0083	1/4	min. 1 1/4	max. 1 1/2
113 0028	1/4	min. 1 1/4	max. 1 1/2
113 0022	1/4	min. 1	max. 1 1/4
113 0152	1/4	min. 1	max. 1 1/4
113 0067	1/4	min. 1	max. 1 1/4
110 0243	1/4	min. 1	max. 1 1/4
110 0025	1/4	min. 1	max. 1 1/4
110 0176	1/4	min. 1	max. 1 1/4
110 0205	1/4	min. 3/4	max. 1
110 0215	1/4	min. 3/4	max. 1
110 0210	1/4	min. 3/4	max. 1
110 0225	1/4	min. 3/4	max. 1
110 0212	1/4	min. 3/4	max. 1

Pentru a asigura un montaj mai usor și o etanșare mai bună se recomanda lubrifierea inelelor cu ulei sau unsoare, potrivite pentru apă potabilă, pentru a obtine o deformare omogena.

1114
Piulita

i Disponibil si in varianta nichelat

Cod	Dimensiune	Pret €	Ambalare
110 0055	18		50/600
110 0233	35		10/50
110 0226	42		10/50
110 0230	54		10/50

1014
Piulita

i Disponibil si in varianta nichelat

Cod	Dimensiune	Pret €	Ambalare
100 0231	08		100/1500
100 0092	10		100/1500
100 0115	12		100/1500
100 0034	15		50/700
100 0035	22		25/400
100 0055	28		25/250

1115
Inel

Cod	Dimensiune	Pret €	Ambalare
110 0150	08		50/8000
110 0179	14		50/3000
110 0163	16		50/2300
110 0077	18		50/2000
110 0198	35		50/300
110 0218	42		50/200
110 0220	54		10/130

Cupru



1015
Inel

Cod	Dimensiune	Pret €	Ambalare
100 0072	10		50/5000
100 0083	12		50/3000
100 0026	15		50/2000
100 0039	22		50/1200
100 0097	28		50/800

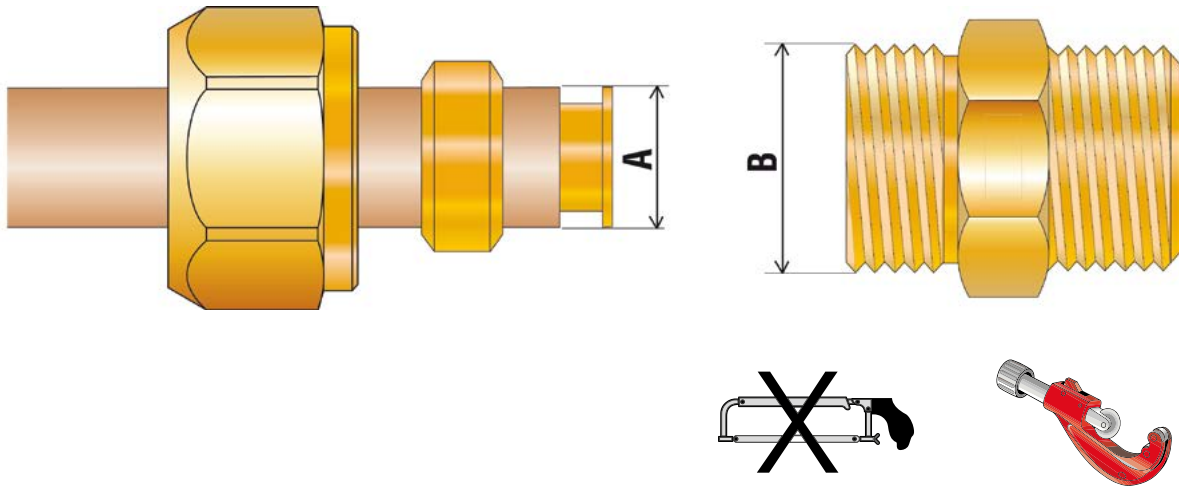

LISTA DE PRETURI

INSTRUCIUNI DE MONTAJ - SERIA 1000/ 1100



TAIEREA TUBULUI

Taierea tevii de cupru se realizeaza cu instrumente speciale, care permit o tăiere fără bavuri și perfect perpendiculara pe axa țevii

DEBAVURAREA SI CURATAREA TEVII

Se debavureaza bine teava si se curata pentru eliminarea eventualelor reziduuri.
La utilizarea tevii de cupru moale utilizati stutul de ranforsare 1116.

MONTAJUL RACORDULUI

Se insereaza piulita si inelul pe teava. Se insurubeaza cu mana cat este posibil apoi in baza dimensiunii a tevii de cupru se strange cu cheia conform tabelului.

Nota: Pentru a asigura un montaj mai usor și o etanșare mai bună se recomanda lubrifierea inelelor cu ulei sau unsoare, potrivite pentru apă potabilă.

TABEL FILETE

A	10	15	18	22	28	35	42	54
B	9/16-24 UNEF-24	G 1/2"	M24 x 1,5	W 1"1/8 x 1/14	W 1"3/8 x 1/14	W 42,06 x 14Tpi	W 49,5 x 11Tpi	W 63,5 x 11Tpi

TABEL DE STRANGERE PIULITE nr ture

A	10	15	18	22	28	35	42	54
Nr ture	1-1/4	1-1/4	1-1/4	1-1/4	1	1	1	1
Cuplu de strangere	15 Nm	70 Nm	85 Nm	110 Nm	125 Nm	225 Nm	390 Nm	560 Nm

Cu **rosu** dimensiunile seriei 1000

07 RACORDURI UNIVERSALE PENTRU CUPRU, PEX SI TUB MULTISTRAT

Seria WATERBLOCK

WATERBLOCK

Racorduri universale pentru cupru, PEX si tub multistrat



132

Racorduri mecanice, de compresie cu adaptori universali pentru conectare pe tuburi pex, tuburi multistrat cu insertie de aluminiu sau tuburi de cupru seria usoara sau seria grea.



GHID DE COMPATIBILITATE

Seria	Tub potrivit	Domeniu de aplicare	Caracteristici tehnice
WATERBLOCK	Cupru	• Apa	Tmax: + 95 °C Pmax: 10 bar
	PE-X "COBRAPEX"	• Apa	Tmax: + 95 °C Pmax: 10 bar
	Multistrat "AL-COBRAPEX"	• Apa	Tmax: + 95 °C Pmax: 10 bar

Pentru detalii suplimentare consultati fisa tehnica



1640GN
Racord drept M

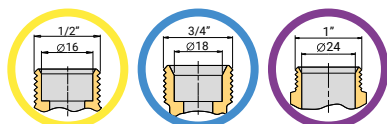

Cod	Dimensiune	Pret €	Ambalare
163 0001	G3/8" - 1/2"(Ø16)		10/500
163 0002	G1/2" - 1/2"(Ø16)		10/350
163 0003	G3/4" - 1/2"(Ø16)		10/250
163 0004	G1/2" - 3/4"(Ø18)		10/250
163 0005	G3/4" - 3/4"(Ø18)		10/200
163 0006	G1" - 3/4"(Ø18)		10/150
163 0007	G3/4" - 1"(Ø24)		10/150
163 0008	G1" - 1"(Ø24)		10/100



1642GN
Racord drept F

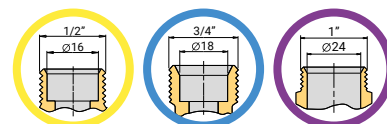

Cod	Dimensiune	Pret €	Ambalare
163 0012	G3/8" - 1/2"(Ø16)		10/400
163 0013	G1/2" - 1/2"(Ø16)		10/300
163 0014	G3/4" - 1/2"(Ø16)		10/200
163 0015	G1/2" - 3/4"(Ø18)		10/250
163 0016	G3/4" - 3/4"(Ø18)		10/200
163 0017	G1" - 3/4"(Ø18)		10/150
163 0018	G3/4" - 1"(Ø24)		10/150
163 0019	G1" - 1"(Ø24)		10/100



1641GN
Racord drept dublu

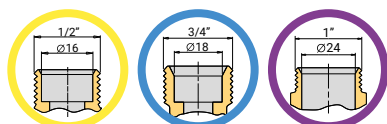

Cod	Dimensiune	Pret €	Ambalare
163 0009	1/2"(Ø16) - 1/2"(Ø16)		10/350
163 0010	3/4"(Ø18) - 3/4"(Ø18)		10/250
163 0011	1"(Ø24) - 1"(Ø24)		10/100



1643GN
Cot dublu

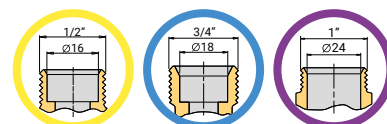

Cod	Dimensiune	Pret €	Ambalare
163 0020	1/2"(Ø16) - 1/2"(Ø16)		10/250
163 0021	3/4"(Ø18) - 3/4"(Ø18)		10/130
163 0022	1"(Ø24) - 1"(Ø24)		10/100

**1644GN**

Cot M

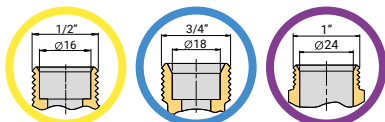

Cod	Dimensiune	Pret €	Ambalare
163 0023	G1/2" - 1/2"(ø16)		10/250
163 0024	G3/4" - 1/2"(ø16)		10/150
163 0025	G1/2" - 3/4"(ø18)		10/150
163 0026	G3/4" - 3/4"(ø18)		10/150
163 0027	G3/4" - 1"(ø24)		10/100
163 0028	G1" - 1"(ø24)		10/100

**1645GN**

Cot F

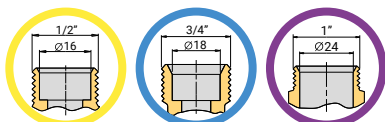

Cod	Dimensiune	Pret €	Ambalare
163 0029	G1/2" - 1/2"(ø16)		10/200
163 0030	G3/4" - 1/2"(ø16)		10/130
163 0031	G1/2" - 3/4"(ø18)		10/150
163 0032	G3/4" - 3/4"(ø18)		10/120
163 0033	G3/4" - 1"(ø24)		10/100
163 0034	G1" - 1"(ø24)		10/100

**1646GN**

Cot F cu flansa

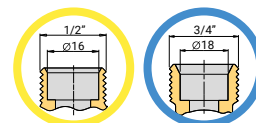

Cod	Dimensiune	Pret €	Ambalare
163 0035	G1/2" - 1/2"(ø16)		10/130
163 0036	G3/4" - 1/2"(ø16)		10/70
163 0037	G1/2" - 3/4"(ø18)		10/80
163 0038	G3/4" - 3/4"(ø18)		10/70

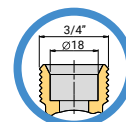
**1649YGN**Racord Y cu piulita si prinderi
3/4" x 18 (Eurocon)

Cod	Dimensiune	Pret €	Ambalare
163 0053	3/4"(ø18) - G 3/4" - 3/4"(ø18)		10/100

**1647GN**

Teu M

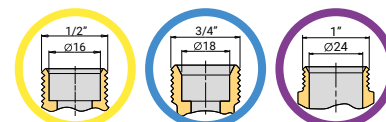

Cod	Dimensiune	Pret €	Ambalare
163 0039	1/2"(ø16) - 1/2"(ø16) - 1/2"(ø16)		10/150
163 0040	3/4"(ø18) - 3/4"(ø18) - 3/4"(ø18)		10/80
163 0041	1"(ø24) - 1"(ø24) - 1"(ø24)		10/50

**1649GN**

Teu F

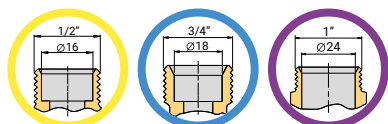

Cod	Dimensiune	Pret €	Ambalare
163 0042	1/2" (Ø16) - G1/2" - 1/2" (Ø16)		10/130
163 0043	3/4" (Ø18) - G1/2" - 3/4" (Ø18)		10/90
163 0044	3/4" (Ø18) - G3/4" - 3/4" (Ø18)		10/70
163 0045	1" (Ø24) - G3/4" - 1" (Ø24)		10/50
163 0046	1" (Ø24) - G1" - 1" (Ø24)		10/50

**1638GN**

Consola cu racorduri finale

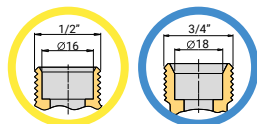

i Interaxe: 100 - 110 - 150 mm

Cod	Dimensiune	Pret €	Ambalare
163 0047	1/2" (Ø16) - G1/2"		1/20
163 0048	3/4" (Ø18) - G1/2"		1/20

**1420K**

Teu F cu racord 24x19fil (Ø18) de utilizat cu 1420P

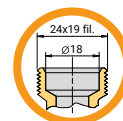

Cod	Dimensiune	Pret €	Ambalare
140 0190	24x19 fil (Ø18) - 1/2" F		10/100

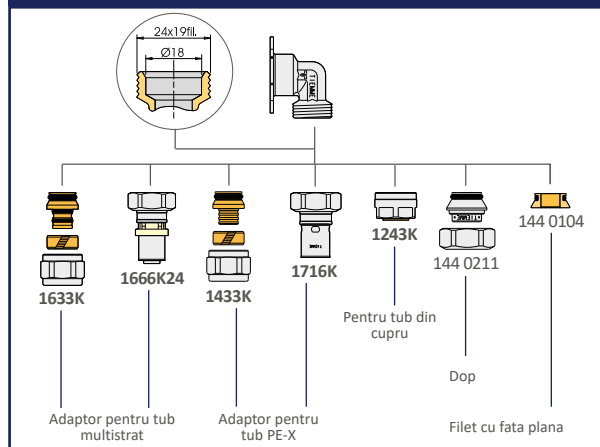
1420K GHID DE CONEXIUNI**1420P**

Doza de plastic pentru art. 1420K

Cod	Dimensiune	Pret €	Ambalare
147 0006	Teaca Ø 23 și Ø 27		1/50

**1420Z**

Suport dublu pentru fixare 1420P

Cod	Interaxe	Pret €	Ambalare
147 0009	38 - 50 - 100		5/50
147 0007	38 - 150		5/50



**1505C04**

Tub de cupru cromat pentru legatura calorifere/alte elemente radiante

Cod	Dimensiune	Pret €	Ambalare
337 0001	Ø15 x 1/2" L=150 mm		2/60

**1481**

Placa pentru cot cu flansa

1646GN

Cod	Dimensiune	Pret €	Ambalare
147 0005	unica		1/100

1420K

EXEMPLU DE UTILIZARE

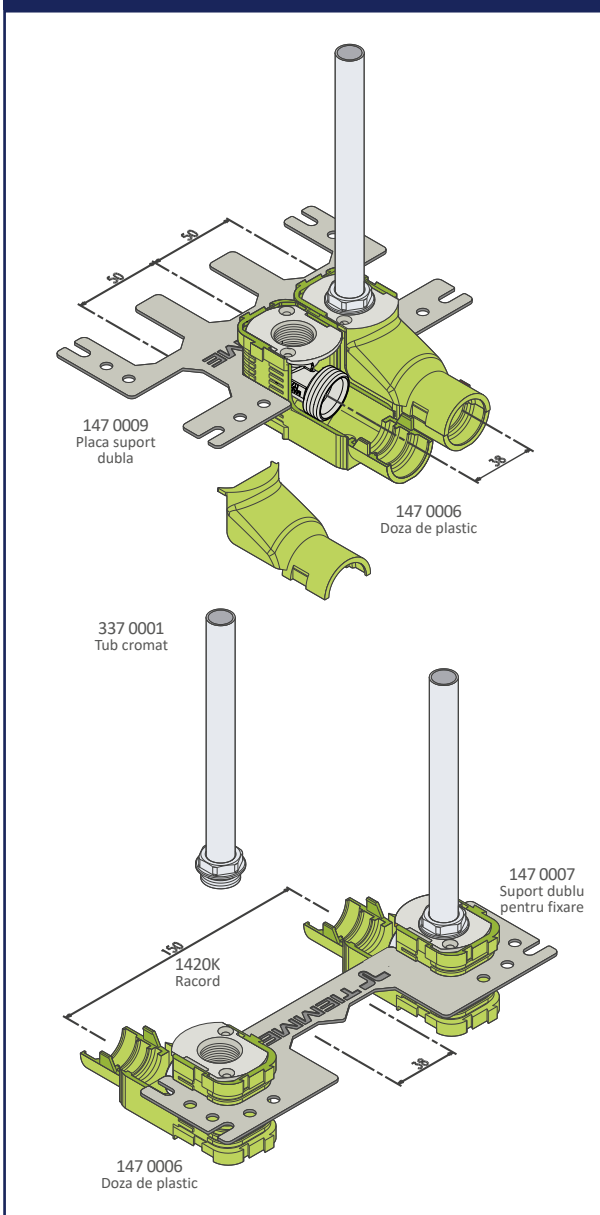

**1435N**

Adaptor pentru conexiuni 1/2"x16. Pentru tub PEX

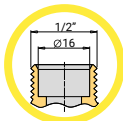

Cod	Dimensiune	Pret €	Ambalare
144 0113	12 x 1,1 - 1/2" (Ø16)		10/350
144 0058	12 x 2,0 - 1/2" (Ø16)		10/350
144 0068	14 x 2,0 - 1/2" (Ø16)		10/350
144 0007	15 x 2,5 - 1/2" (Ø16)		10/350
144 0098	16 x 1,5 - 1/2" (Ø16)		10/350
144 0264	16 x 1,8 - 1/2" (Ø16)		10/300
144 0004	16 x 2,0 - 1/2" (Ø16)		10/300
144 0037	16 x 2,2 - 1/2" (Ø16)		10/300

Până la terminarea stocului

**1635N**

Adaptor pentru conexiuni 1/2"x16. Pentru tub MULTISTRAT

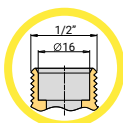

Cod	Dimensiune	Pret €	Ambalare
144 0010	14 x 2,0 - 1/2" (Ø16)		10/350
144 0001	16 x 2,0 - 1/2" (Ø16)		10/300
144 0021	16 x 2,25 - 1/2" (Ø16)		10/300

**1716**

Racord drept cu piulita pentru conexiuni 1/2"x16. Pentru tub PEX

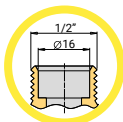

Cod	Dimensiune	Pret €	Ambalare
170 0103	16 x 1,8 - 1/2" (Ø16)		10/100
170 0082	16 x 2,0 - 1/2" (Ø16)		10/100
170 0093	20 x 1,9 e 2,0 - 1/2" (Ø16)		10/100

**1668**

Racord drept cu piulita pentru conexiuni 1/2"x16. Pentru tub MULTISTRAT

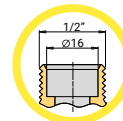

Cod	Dimensiune	Pret €	Ambalare
165 0028	16 - 1/2" (Ø16)		10/100
165 0077	20 - 1/2" (Ø16)		10/100

**1240N**

Piulita si inel de compresie pentru conexiuni 1/2"x16. Pentru tub din CUPRU

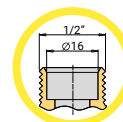

Cod	Dimensiune	Pret €	Ambalare
144 0028	10 - 1/2" (Ø16)		10/400
144 0005	12 - 1/2" (Ø16)		10/400
144 0013	14 - 1/2" (Ø16)		10/400
144 0016	15 - 1/2" (Ø16)		10/400
144 0025	16 - 1/2" (Ø16)		10/400

NOUȚĂ!

**1859A16**

Adaptor pentru a transforma un filet 1/2"x16 in filet cu fata plana

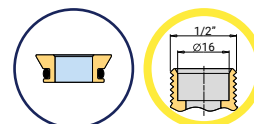

Cod	Dimensiune	Pret €	Ambalare
144 0311	1/2" (Ø16)		10/400

**1879**

Racord terminal

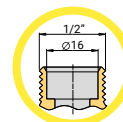

Cod	Dimensiune	Pret €	Ambalare
144 0063	1/2" (Ø16)		10/300

**1436N**

Adaptor pentru conexiuni 3/4"x18 (EUROCONO). Pentru tub PEX

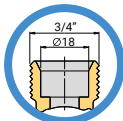

Cod	Dimensiune	Pret €	Ambalare
144 0254	12 x 1,1 - 3/4" (Ø18)		10/250
144 0054	12 x 2,0 - 3/4" (Ø18)		10/250
144 0059	14 x 2,0 - 3/4" (Ø18)		10/250
144 0078	15 x 1,5 - 3/4" (Ø18)		10/250
144 0036	15 x 2,5 - 3/4" (Ø18)		10/250
144 0042	16 x 1,5 - 3/4" (Ø18)		10/250
144 0255	16 x 1,8 - 3/4" (Ø18)		10/250
144 0011	16 x 2,0 - 3/4" (Ø18)		10/250
144 0047	16 x 2,2 - 3/4" (Ø18)		10/250
144 0012	17 x 2,0 - 3/4" (Ø18)		10/200
144 0043	18 x 2,0 - 3/4" (Ø18)		10/200
144 0052	18 x 2,5 - 3/4" (Ø18)		10/200
144 0019	20 x 2,0 - 3/4" (Ø18)		10/200
144 0056	20 x 2,8 - 3/4" (Ø18)		10/200

**1636N**

Adaptor pentru conexiuni 3/4"x18 (EUROCONO). Pentru tub MULTISTRAT

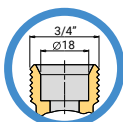

Cod	Dimensiune	Pret €	Ambalare
144 0045	14 x 2,0 - 3/4" (Ø18)		10/250
144 0002	16 x 2,0 - 3/4" (Ø18)		10/250
144 0055	16 x 2,25 - 3/4" (Ø18)		10/250
144 0231	16,2 x 2,6 - 3/4" (Ø18)		10/250
144 0033	17 x 2,0 - 3/4" (Ø18)		10/200
144 0014	18 x 2,0 - 3/4" (Ø18)		10/200
144 0003	20 x 2,0 - 3/4" (Ø18)		10/200
144 0023	20 x 2,25 - 3/4" (Ø18)		10/200
144 0038	20 x 2,5 - 3/4" (Ø18)		10/200

**1716**

Racord drept cu piulita pentru conexiuni 3/4"x18 (EUROCONO). Pentru tub PEX

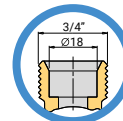

Cod	Dimensiune	Pret €	Ambalare
170 0321	12 x 1,1 - 3/4" (Ø18)		10/100
170 0137	16 x 1,5 - 3/4" (Ø18)		10/100
170 0090	16 x 1,8 - 3/4" (Ø18)		10/100
170 0086	16 x 2,0 - 3/4" (Ø18)		10/100
170 0352	17 x 2,0 - 3/4" (Ø18)		10/100
170 0089	20 x 1,9 e 2,0 - 3/4" (Ø18)		10/100
170 0081	25 x 2,3 - 3/4" (Ø18)		2/100

**1666**

Racord drept cu piulita pentru conexiuni 3/4"x18 (EUROCONO). Pentru tub MULTISTRAT

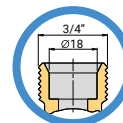

Cod	Dimensiune	Pret €	Ambalare
165 0076	16 - 3/4" (Ø18)		10/100
165 0110	20 - 3/4" (Ø18)		10/100

**1859**

Adaptor pentru a transforma un filet 3/4"x18 (EUROCONO) in filet cu fata plana

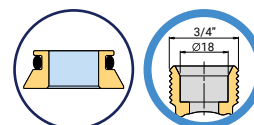

Cod	Dimensiune	Pret €	Ambalare
144 0104	3/4" (Ø18)		10/400

**1241N**

Piulita si inel de compresie pentru conexiuni 3/4"x18 (EUROCONO). Pentru tub din CUPRU

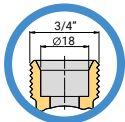

Cod	Dimensiune	Pret €	Ambalare
144 0072	10 - 3/4" (Ø18)		10/250
144 0030	12 - 3/4" (Ø18)		10/250
144 0034	14 - 3/4" (Ø18)		10/250
144 0008	15 - 3/4" (Ø18)		10/250
144 0027	16 - 3/4" (Ø18)		10/250
144 0018	18 - 3/4" (Ø18)		10/250

**1879**

Racord terminal

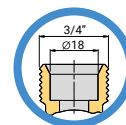

Cod	Dimensiune	Pret €	Ambalare
144 0071	3/4" (Ø18)		10/250

**1636N06**

Adaptor pentru conexiuni 1"x24. Pentru tub MULTISTRAT

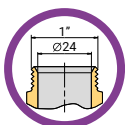

Cod	Dimensiune	Pret €	Ambalare
144 0239	16 x 2,0 - 1" (Ø24)		10/150
144 0240	20 x 2,0 - 1" (Ø24)		10/150
144 0241	26 x 3,0 - 1" (Ø24)		10/150



ADAPTORI PENTRU TUB DE CUPRU - REF. 1240 - 1241

NUMARUL DE ROTATII PENTRU PIULITA					
Ø 10 - 1/2" (Ø16) 1-1/4=10 Nm	Ø 12 - 1/2" (Ø16) 1-1/4=10 Nm	Ø 14 - 1/2" (Ø16) 1-1/4=10 Nm	Ø 15 - 1/2" (Ø16) 1-1/4=12 Nm	Ø 16 - 1/2" (Ø16) 1-1/4=12 Nm	Ø 10 - 3/4" (Ø18) 1-1/4=9 Nm
Ø 12 - 3/4" (Ø18) 1-1/4=9 Nm	Ø 14 - 3/4" (Ø18) 1-1/4=9 Nm	Ø 15 - 3/4" (Ø18) 1-1/4=9 Nm	Ø 16 - 3/4" (Ø18) 1-1/4=12 Nm	Ø 18 - 3/4" (Ø18) 1-1/4=15 Nm	

DACA ESTE NECESAR SE MAI POT APLICA PANA LA 1/4-1/2 ROTATII ULTERIOARE

ADAPTORI PENTRU TUBURI PEX - REF. 1435-1436

NUMARUL DE ROTATII PENTRU PIULITA					
12x1,1 - 1/2" (Ø16) 1=25 Nm	12x2,0 - 1/2" (Ø16) 1=28 Nm	14x2,0 - 1/2" (Ø16) 1=28 Nm	15x2,5 - 1/2" (Ø16) 1=28 Nm	16x1,5 - 1/2" (Ø16) 1=28 Nm	16x1,8 - 1/2" (Ø16) 1=28 Nm
16x2,0 - 1/2" (Ø16) 1=29 Nm	16x2,2 - 1/2" (Ø16) 1=29 Nm	12x1,1 - 3/4" (Ø18) 1=23 Nm	12x2,0 - 3/4" (Ø18) 1=30 Nm	14x2,0 - 3/4" (Ø18) 1=30 Nm	15x1,5 - 3/4" (Ø18) 1=30 Nm
15x2,5 - 3/4" (Ø18) 1=30 Nm	16x1,5 - 3/4" (Ø18) 1=31 Nm	16x2,0 - 3/4" (Ø18) 1=32 Nm	16x2,2 - 3/4" (Ø18) 1=32 Nm	17x2,0 - 3/4" (Ø18) 1=40 Nm	18x2,0 - 3/4" (Ø18) 1=40 Nm
18x2,5 - 3/4" (Ø18) 1=40 Nm	20x2,0 - 3/4" (Ø18) 1=44 Nm	20x2,8 - 3/4" (Ø18) 1=44 Nm			

ADAPTORI PENTRU TUBURI MULTISTRAT AL-COBRAPEX - REF. 1635-1636-1636N06

NUMARUL DE ROTATII PENTRU PIULITA					
14x2,0 - 1/2" (Ø16) 1=28 Nm	16x2,0 - 1/2" (Ø16) 1=30 Nm	16x2,25 - 1/2" (Ø16) 1=30 Nm	14x2,0 - 1/2" (Ø16) 1=30 Nm	16x2,0 - 3/4" (Ø18) 1=33 Nm	16x2,25 - 3/4" (Ø18) 1=33 Nm
17x2,0 - 3/4" (Ø18) 1=40 Nm	18x2,0 - 3/4" (Ø18) 1=40 Nm	20x2,0 - 3/4" (Ø18) 1=45 Nm	20x2,25 - 3/4" (Ø18) 1=45 Nm	20x2,5 - 3/4" (Ø18) 1=45 Nm	16x2,0 - 1" (Ø24) 1=35 Nm
20x2,0 - 1" (Ø24) 1=48 Nm	26x3,0 - 1" (Ø24) 1=53 Nm				

**08A Tub multistrat "AL-COBRAPEX"**

Tub multistrat "AL-COBRAPEX"



142

Unelte



145

08B Tub polietilena reticulata "COBRAPEX"

Tub polietilena reticulata "COBRAPEX"



150

Tub din polietilena de inalta densitate cu bariera anti-oxigen "COBRAPEX OXISTOP"



153

Unelte



155



0660

Tub multistrat din polietilena reticulata cu insertie de aluminiu - Culoare alba

Cod	Dim.	Allum.	Pret €/m	Ambalare (m)
060 0001	16 x 2,0	0,20		100/3200
060 0003	20 x 2,0	0,25		100/1800
060 0019	25 x 2,5	0,35		50/1200
060 0007	26 x 3,0	0,35		50/900
060 0014	32 x 3,0	0,40		25/450
060 0064	32 x 3,0	0,40		50/800



0600B 0660B

Tub multistrat din polietilena reticulata cu insertie de aluminiu - Culoare alba, in bare

Cod	Dim.	Allum.	Pret €/m	Ambalare
060 0026	16 x 2,0	0,20		4 m x 60 pz= 240 m
060 0023	20 x 2,0	0,25		4 m x 40 pz= 160 m
060 0027	25 x 2,5	0,35		4 m x 20 pz= 80 m
060 0025	26 x 3,0	0,35		4 m x 20 pz= 80 m
060 0022	32 x 3,0	0,40		4 m x 15 pz= 60 m
060 0005	40 x 3,5	0,80		4 m x 5 pz= 20 m
060 0009	50 x 4,0	1,00		4 m x 5 pz= 20 m
060 0008	63 x 4,5	1,20		4 m x 3 pz= 12 m
060 0071	75 x 5,0	1,35		5 m x 1 pz= 5 m
060 0073	90 x 7,0	1,35		5 m x 1 pz= 5 m

La cerere



0660S

Tub multistrat din polietilena reticulata cu insertie de aluminiu, fara cutie, ambalat la palet - Culoare alba

Cod	Dim.	Allum.	Pret €/m	Ambalare (m)
060 0067	16 x 2,0	0,20		100/5600
060 0068	16 x 2,0	0,20		200/5600
060 0015	16 x 2,0	0,20		500/6000
060 0070	20 x 2,0	0,25		100/3200
060 0072	26 x 3,0	0,35		50/1200

Se vinde doar ambalat la palet



0630B

Tub multistrat din polietilena reticulata cu insertie de aluminiu imbracat in izolatie albastra

Cod	Dim.	Allum.	Grosime	Pret €/m	Ambalare (m)
062 0004	16 x 2,0	0,20	6 mm		50/850
062 0014	16 x 2,0	0,20	6 mm		100/1100
062 0006	20 x 2,0	0,25	6 mm		50/700
062 0026	25 x 2,5	0,35	6 mm		50/500
062 0005	26 x 3,0	0,35	6 mm		50/500
062 0022	32 x 3,0	0,40	6 mm		25/250



0630R

Tub multistrat din polietilena reticulata cu insertie de aluminiu imbracat in izolatie rosie

Cod	Dim.	Allum.	Grosime	Pret €/m	Ambalare (m)
062 0001	16 x 2,0	0,20	6 mm		50/850
062 0009	16 x 2,0	0,20	6 mm		100/1100
062 0003	20 x 2,0	0,25	6 mm		50/700
062 0025	25 x 2,5	0,35	6 mm		50/500
062 0002	26 x 3,0	0,35	6 mm		50/500
062 0010	32 x 3,0	0,40	6 mm		25/250



0635

Tub multistrat din polietilena reticulata cu insertie de aluminiu imbracat in izolatia verde pentru climatizare

Cod	Dim.	Allum.	Grosime	Pret €/m	Ambalare (m)
062 0019	16 x 2,0	0,20	10 mm		50/500
062 0008	20 x 2,0	0,25	10 mm		50/450
062 0015	26 x 3,0	0,35	10 mm		25/250
062 0075	32 x 3,0	0,40	10 mm		25/250



0636

Tub multistrat 0660 imbracat in izolatia gri pentru climatizare (Euroclase BL-s1-d0)

Cod	Dim.	Allum.	Grosime	Pret €/m	Ambalare (m)
062 0086	16 x 2,0	0,20	10 mm		50/500
062 0087	20 x 2,0	0,25	13 mm		50/400
062 0088	26 x 3,0	0,35	13 mm		25/225
062 0089	32 x 3,0	0,40	13 mm		25/200



0640B

Tub multistrat din polietilena reticulata cu insertie de aluminiu in teaca ondulata de culoare albastra

Cod	Dimensiune	Allum.	Pret €/m	Ambalare (m)
064 0001	16 x 2,0	0,20		50/1350
064 0004	16 x 2,0	0,20		100/1200
064 0003	20 x 2,0	0,25		50/1350



0640R

Tub multistrat din polietilena reticulata cu insertie de aluminiu in teaca ondulata de culoare rosie

Cod	Dimensiune	Allum.	Pret €/m	Ambalare (m)
064 0002	16 x 2,0	0,20		50/1350
064 0005	16 x 2,0	0,20		100/1200
064 0006	20 x 2,0	0,25		50/1350



0641

Tub multistrat 0660 AL-COBRAPEX TWIN cu teaca ondulata gri

Cod	Dimensiune	Allum.	Pret €/m	Ambalare (m)
064 0019	16 x 2,0	0,20		50/1200
064 0020	20 x 2,0	0,25		50/700



0900B

Teaca ondulata de protectie de culoare albastra, pentru trecerea tubului prin profilul de dilatare

Cod	Dimensiune	Pret €/m	Ambalare (m)
090 0004	∅ int.=19 mm		100/2800
090 0010	∅ int.=23 mm		50/1400
090 0003	∅ int.=23 mm		100/2800
090 0008	∅ int.=28 mm		50/1000



0900R

Teaca ondulata de protectie de culoare rosie, pentru trecerea tubului prin profilul de dilatare

Cod	Dimensiune	Pret €/m	Ambalare (m)
090 0005	∅ int.=19 mm		100/2800
090 0001	∅ int.=23 mm		50 /1400
090 0002	∅ int.=23 mm		100/2800
090 0007	∅ int.=28 mm		50/1000



0625

Dispozitiv de etansare din PVC transparent pentru protejarea tevii

Cod	Dimensiune	Pret €	Ambalare
060 0034	12		10/250
060 0046	14		10/250
060 0036	16		10/250
060 0038	18		10/250
060 0037	20		10/250

GHID DE SELECTARE A FITINGURILOR TIEMME

Fitinguri de compresie pentru teava multistrat "AL-COBRAPEX" - seria 1600

Cap. 02



Fitinguri prin presare pentru teava multistrat „AL-COBRAPEX” - seria 1650

Cap. 03A





1699
Instrument de montare a
mansonului din oțel inoxidabil

Cod	Dimensiune	Pret €	Ambalare
159 0056	16		1/25
159 0054	20		1/25
159 0055	26		1/20
159 0053	32		1/10
159 0057	40		1/10
159 0120	50		1/5
159 0121	63		1/5

1699

EXEMPLU DE UTILIZARE

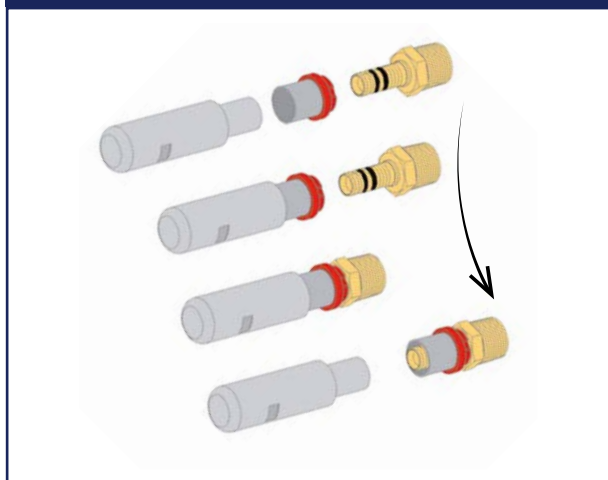

1495
Foaie pentru tuburi

Cod	Dimensiune	Pret €	Ambalare
034 0015	0 - 35		1/5

Lama de rezerva disponibila cod. 159 0066



1496
Foaie pentru tuburi

Cod	Dimensiune	Pret €	Ambalare
034 0030	14 - 16 - 18 - 20		1/1



1683
Foaie circulară pentru tuburi
prevăzută cu mini debavurator

Cod	Dimensiune	Pret €	Ambalare
034 0032	0 - 32		1/12
034 0034	0 - 67		1/6
034 0083	50-127		1/3



1682
Debavurator

Cod	Dimensiune	Pret €	Ambalare
034 0026	unica		1/15



4530
Derulator teava

Cod	Dimensiune	Pret €	Ambalare
450 0028	-		1/1



1689
Trusa indreptat tevi

Cod	Dimensiune	Pret €	Ambalare
034 0004	14 - 26		1/1



1684
Echipament pentru îndoit țevi Al-Cobrapex

Cod	Dimensiune	Pret €	Ambalare
034 0016	16 - 32		1/1



1497
1497EST
Arc de indoit tub

Cod	Dimensiune	Pret €	Ambalare
Pentru interiorul tubului L = 100 cm			
034 0001	16		1/50
034 0007	20		1/50
034 0020	25 - 26		1/20
Pentru interiorul tubului L = 50 cm			
034 0002	16		1/20
034 0005	20		1/20
034 0080	26		1/20



1498SET
Trusa debavurator completa

i Conține maner interschimbabil si accesorii

Cod	Dimensiune	Pret €	Ambalare
034 0018	14 ÷ 40		1/1
034 0011	16 - 20 - 25 - 26		1/1

Ø14x2,0 - Ø16x2,0 - Ø18x2,0 - Ø20x2,0 - Ø25x2,5 - Ø26x3,0 - Ø32x3,0 - Ø40x3,5



1498UM
Debavurator cu maner in forma de "T"

Cod	Dimensiune	Pret €	Ambalare
034 0006	16 x 2,0		1/1
034 0008	20 x 2,0		1/1
034 0009	25 x 2,5 - 26 x 3,0		1/1
034 0014	32 x 3,0		1/1



1498MT
Maner interschimbabil in forma de "T"

i De utilizat cu 1498US pentru operatiuni manuale

Cod	Dimensiune	Pret €	Ambalare
034 0017	-		1/1



1498US
Debavurator interschimbabil

Cod	Dimensiune	Pret €	Ambalare
034 0021	16 x 2,0		1/100
034 0023	20 x 2,0		1/100
034 0024	25 x 2,5 - 26 x 3,0		1/100
034 0027	32 x 3,0		1/100
034 0025	40 x 3,5		1/100
034 0028	50 x 4,0		1/100
034 0031	63 x 4,5		1/100

De utilizat cu 1498MT pentru operatiuni manuale sau cu bormasina

De utilizat cu cheie tubulara hexagonala de 10





1695TM01
Presa cu baterie TIEMME (standard) pentru tub de la 16 la 90 inclusiv 90

i Presa se livrează într-o cutie ce conține: baterie reincarcabila Li-Ion 18Vdc - 2,0 Ah; încărcător de baterie; set de clești (daca este prevazut) Ø 16, 20, 26

Cod	Set capete presare	Pret €	Ambalare
159 0085	Nu sunt incluse		1/1
159 0086	16 - 20 - 26		1/1



1695TM02
Presa cu baterie TIEMME (MINI) pentru tub de la 16 la 32 inclusiv 32

i Presa se livrează într-o cutie ce conține: baterie reincarcabila Li-Ion 18Vdc - 2,0 Ah; încărcător de baterie.

Cod	Set capete presare	Pret €	Ambalare
159 0106	Nu sunt incluse		1/1



1695TM03
Presa cu baterie TIEMME (MINI) pentru tub de la 16 la 32 inclusiv 32

i Presa se livrează într-o cutie ce conține: baterie reincarcabila Li-Ion 18Vdc - 2,0 Ah; încărcător de baterie; set de clești (daca este prevazut) Ø 16, 20, 26

Cod	Set capete presare	Pret €	Ambalare
159 0089	Nu sunt incluse		1/1
159 0090	16 - 20 - 26		1/1



1695TM01B
Baterie Li-Ion 18Vdc / 2,0 Ah pentru presa 1695TM01

Cod	Dimensiune	Pret €	Ambalare
159 0087	18Vdc/2,0 Ah		1/1



1695TM02B
Baterie Li-ION pentru presa TIEMME (MINI)

Cod	Set capete presare	Pret €	Ambalare
159 0110	18Vdc/2,0 Ah		1/1



1695TM03B
Baterie Li-ION 12Vdc / 2 Ah pentru presa TIEMME (MINI) 1695TM03

Cod	Dimensiune	Pret €	Ambalare
159 0091	12Vdc/2,0 Ah		1/1



1695TM01C
Încărcător baterie Li-ION pentru presa TIEMME (standard)

Cod	Dimensiune	Pret €	Ambalare
159 0088	230 Vac		1/1



1695TM02C
Încărcător baterie Li-ION pentru presa TIEMME (MINI)

Cod	Dimensiune	Pret €	Ambalare
159 0111	230 Vac		1/1



1695TM03C
Încărcător de baterie pentru 1695TM03B

Cod	Dimensiune	Pret €	Ambalare
159 0092	230 Vac		1/1



1681

Capete de presare - TH PROFILE
- personalizat TIEMME

Cod	Dimensiune	Pret €	Ambalare
159 0005	16		1/1
159 0004	20		1/1
159 0030	25		1/1
159 0006	26		1/1
159 0001	32		1/1
159 0010	40		1/1
159 0008	50		1/1
159 0012	63		1/1
159 0123	75		1/1
159 0101	75		1/1
159 0117	90		1/1

Capete de presare cu 3 sectoare

Capete de presare cu 3 sectoare pentru profil U pentru 165 1256 si 165 1267

Capete de presare cu 4 sectoare

Capete de presare 4 sectoare pentru profil U



1681MINI

Capete de presare - TH PROFILE
- personalizat TIEMME pentru
presa MINI

Cod	Dimensiune	Pret €	Ambalare
159 0025	16		1/1
159 0027	20		1/1
159 0024	25		1/1
159 0036	26		1/1
159 0028	32		1/1

DIMENSIUNI DE GABARIT PENTRU CAPETELE DE PRESARE

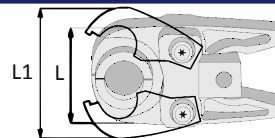

Cod	Dimensiune	L (mm)	L1 (mm)
159 0005	16	101	104
159 0004	20	101	104
159 0030	25	101	115
159 0006	26	101	115
159 0001	32	101	115
159 0010	40	101	120
159 0008	50	165	175
159 0012	63	175	185
159 0123	75	140	-
159 0101	75	140	-
159 0117	90	160	200
159 0025	16	101	101
159 0027	20	101	101
159 0024	25	101	108
159 0036	26	101	108
159 0028	32	101	108

L=falcile in pozitia inchis
L1=falcile in pozitia deschis



INSTRUCȚIUNI PENTRU PREGĂTIREA TUBULUI

Pentru a obține o îmbinare perfectă, indiferent de tipul de fitting care va fi folosit ulterior, trebuie efectuate câteva operații simple, dar importante pentru pregătirea țevii.

- Mai întâi trebuie să tăiați tubul la dimensiunea dorită. Pentru a efectua tăierea este indicat să folosiți un tăietor de țevi sau foarfeca adecvată, asigurându-vă că tăierea este cât mai perpendiculară pe axa țevii în (Fig.1).
- Apoi se procedează la debavurarea și calibrarea țevii cu ajutorul instrumentului indicat în Fig. 2. Debavuratorul este introdus în țeavă și apoi rotit în sensul acelor de ceasornic.

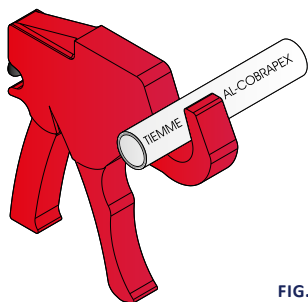

FIG. 1

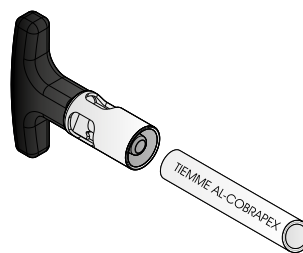

FIG. 2



0300B

Tub din polietilena reticulata de inalta densitate - de culoare alba

i De culoare tub

i La cerere, colacii pot fi de lungime 120 - 200 m (Până la Ø 20 mm)

Cod	Dimensiune	Pret €/m	Ambalare (m)
030 0001	16 x 2,0		100/3000
030 0222	16 x 2,0		300/3600
030 0002	16 x 2,2		100/3000
999 0060	17 x 2,0		100/1800
030 0005	20 x 2,0		100/1800
030 0013	25 x 2,3		50/1350
030 0021	32 x 2,9		50/750
030 0028	40 x 3,7		50/500
030 0029	50 x 4,6		50/250
030 0030	63 x 5,8		50/350

Pentru racorduri vezi Cap. 09

Pana la terminarea stocului



0330B

Tub Pex imbracat in izolatia albastra

i De culoare tub
Culoare izolatia

Cod	Dim.	Allum.	Pret €/m	Ambalare (m)
033 0004	16 x 2,0	6 mm		100/1300
033 0003	20 x 2,0	6 mm		100/1200
033 0009	25 x 2,3	6 mm		50/500



0300BB

Tub din polietilena reticulata de inalta densitate - de culoare alba in bare

i De culoare tub

Cod	Dimensiune	Pret €/m	Ambalare
030 0147	16 x 2,0		4 m x 10 pz= 40m
030 0148	16 x 2,2		4 m x 10 pz= 40m
030 0154	20 x 2,0		4 m x 10 pz= 40m
030 0157	25 x 2,3		4 m x 10 pz= 40m
030 0160	32 x 2,9		4 m x 10 pz= 40m
030 0163	40 x 3,7		4 m x 10 pz= 40m
030 0164	50 x 4,6		4 m x 5 pz= 20m
030 0165	63 x 5,8		4 m x 4 pz= 16m

Pentru racorduri vezi Cap. 09



0330R

Tub Pex imbracat in izolatia rosie

i De culoare tub
Culoare izolatia

Cod	Dim.	Allum.	Pret €/m	Ambalare (m)
033 0001	16 x 2,0	6 mm		100/1300
033 0002	20 x 2,0	6 mm		100/1200
033 0006	25 x 2,3	6 mm		50/500



0300N

Tub din polietilena reticulata de inalta densitate - de culoare neagra

i De culoare tub ■

i La cerere, colacii pot fi de lungime 120 -200 m (Până la Ø 20 mm)

Cod	Dimensiune	Pret €/m	Ambalare (m)
030 0004	16 x 2,0		100/3000
030 0017	16 x 2,2		100/3000
030 0042	20 x 2,0		100/1800
030 0072	25 x 2,3		50/1350
030 0223	32 x 2,9		50/750
030 0034	40 x 3,7		50/500
030 0036	50 x 4,6		50/350
030 0041	63 x 5,8		50/350

Pentru racorduri vezi Cap. 09



0300BL

Tub din polietilena reticulata de inalta densitate - de culoare albastra

i De culoare tub ■

Cod	Dimensiune	Pret €/m	Ambalare (m)
030 0245	16 x 2,0		100/3000
030 0264	16 x 2,0		200/3600
030 0246	20 x 2,0		100/1800
030 0218	25 x 2,3		50/1350
030 0219	32 x 2,9		50/750



0300R

Tub din polietilena reticulata de inalta densitate - de culoare rosie

i De culoare tub ■

Cod	Dimensiune	Pret €/m	Ambalare (m)
030 0207	16 x 2,0		300/3600
030 0225	16 x 2,0		600/3000
030 0202	16 x 2,0		500/1500
030 0237	20 x 2,0		300/2400
030 0238	20 x 2,0		500/2500
030 0247	25 x 2,3		50/1350
030 0214	32 x 2,9		50/750

08_B TUB DIN POLIETILENA RETICULATA "COBRAPEX"

Flexibilitate inalta pentru instalatii substituibile – protectie gofrata



0800B

Tub Pex in teacă ondulata albastra

i De culoare tub
Culoare teacă

Cod	Dim.	Ø ext. teacă	Pret €/m	Ambalare (m)
080 0009	16 x 2,0	24		50/1350
080 0019	16 x 2,0	28		50/1350
080 0010	16 x 2,2	24		50/1350
080 0030	20 x 2,0	28		50/1350
080 0051	25 x 2,3	33		50/750



0810B

Tub Pex negru in teaca ondulata albastra

i De culoare tub
Culoare teacă

Cod	Dim.	Ø ext. teacă	Pret €/m	Ambalare (m)
080 0002	16 x 2,0	24		50/1350
080 0001	16 x 2,0	28		50/1350
080 0044	20 x 2,0	28		50/1350



0800R

Tub Pex in teacă ondulata rosie

i De culoare tub
Culoare teacă

Cod	Dim.	Ø ext. teacă	Pret €/m	Ambalare (m)
080 0006	16 x 2,0	24		50/1350
080 0024	16 x 2,0	28		50/1350
080 0014	16 x 2,2	24		50/1350
080 0028	20 x 2,0	28		50/1350
080 0054	25 x 2,3	33		50/750



0810R

Tub Pex negru in teaca ondulata rosie

i De culoare tub
Culoare teacă

Cod	Dim.	Ø ext. teacă	Pret €/m	Ambalare (m)
080 0004	16 x 2,0	24		50/1350
080 0003	16 x 2,0	28		50/1350
080 0042	20 x 2,0	28		50/1350





0200B

Tub din polietilena reticulata de inalta densitate cu bariera oxigen - culoare alba

i De culoare tub

i La cerere pot fi furnizate si la alte lungimi

Cod	Dimensiune	Pret €/m	Ambalare (m)
020 0005	16 x 2,0		120/3240
020 0018	16 x 2,0		200/3600
020 0003	16 x 2,0		300/3600
020 0001	16 x 2,0		600/3000
020 0008	17 x 2,0		120/3240
020 0071	17 x 2,0		200/3200
020 0006	17 x 2,0		300/2700
020 0002	17 x 2,0		600/3000
020 0011	20 x 2,0		120/2160
020 0012	20 x 2,0		300/2400
020 0004	20 x 2,0		500/2500
020 0146	25 x 2,3		50/1350
020 0009	25 x 2,3		300/1500
020 0059	32 x 2,9		50/750



0200R

Tub din polietilena reticulata de inalta densitate cu bariera oxigen - culoare rosie

i De culoare tub

Cod	Dimensiune	Pret €/m	Ambalare (m)
020 0074	16 x 2,0		300/3600
020 0090	16 x 2,0		600/3000
020 0128	17 x 2,0		600/3000
020 0104	20 x 2,0		300/2400
020 0079	25 x 2,3		50/1350



0230B

Tub Pex cu bariera oxigen imbracat in izolatie albastra

i De culoare tub
Culoare izolatia

Cod	Dimensiune	Allum.	Pret €/m	Ambalare (m)
023 0001	16 x 2,0	6 mm		100/1300



0230R

Tub Pex cu bariera oxigen imbracat in izolatie rosie

i De culoare tub
Culoare izolatia

Cod	Dimensiune	Allum.	Pret €/m	Ambalare (m)
023 0002	16 x 2,0	6 mm		100/1300

Flexibilitate inalta pentru instalatii substituibile – protectie gofrata



0805B

Tub Pex cu bariera oxigen in teacă ondulata albastra

i De culoare tub
Culoare teacă

Cod	Dim.	Ø ext. teacă	Pret €/m	Ambalare (m)
024 0003	16 x 2,0	28		50/1350
024 0002	16 x 2,0	24,5		100/1200



0805R

Tub Pex cu bariera oxigen in teacă ondulata rosie

i De culoare tub
Culoare teacă

Cod	Dim.	Ø ext. teacă	Pret €/m	Ambalare (m)
024 0004	16 x 2,0	28		50/1350
024 0001	16 x 2,0	24,5		100/1200



0900B

Teacă ondulata de protectie de culoare albastra, pentru trecerea tubului prin profilul de dilatare

Cod	Dimensiune	Pret €/m	Ambalare (m)
090 0004	Ø int.=19 mm		100/2800
090 0010	Ø int.=23 mm		50/1400
090 0003	Ø int.=23 mm		100/2800
090 0008	Ø int.=28 mm		50/1000



0900R

Teacă ondulata de protectie de culoare rosie, pentru trecerea tubului prin profilul de dilatare

Cod	Dimensiune	Pret €/m	Ambalare (m)
090 0005	Ø int.=19 mm		100/2800
090 0001	Ø int.=23 mm		50/1400
090 0002	Ø int.=23 mm		100/2800
090 0007	Ø int.=28 mm		50/1000

GHID PENTRU ALEGEREA RACORDURILOR TIEMME

Fitinguri de compresie pentru teava Pex "COBRAPEX" - seria 1400

Cap. 4



Fitinguri pentru țevi Pex "COBRAPEX" - seria 1700

Cap. 5



INSTRUCTIUNI PENTRU TAIEREA TUBULUI

Pentru a obține o îmbinare perfectă, indiferent de tipul de fitting care va fi folosit ulterior, trebuie efectuate câteva operații simple, dar importante pentru pregătirea țevii.

- Continuați să tăiați tubul la dimensiunea dorită. Pentru a efectua tăierea este indicat să folosiți un tăietor de țevi sau foarfeca adecvată, asigurându-vă că tăierea este cât mai perpendiculară pe axa țevii în sine (Fig.1).



FIG. 1



1480P

Cot la 90° din plastic pentru protectia si sustinerea tubului „COBRAPEX” in apropierea racordului la colectorul de distributie

Cod	Dimensiune	Pret €	Ambalare
034 0076	10 - 12		50/300
034 0077	16 - 18		25/500
034 0078	20 - 22		25/100
034 0079	25		25/100



4530

Derulator teava

Cod	Dimensiune	Pret €	Ambalare
450 0028	-		1/1



1495

Foarfecă pentru tuburi

Cod	Dimensiune	Pret €	Ambalare
034 0015	0 - 35		1/5

Lama de rezerva disponibila cod. 159 0066



1495R63

Foarfecă pentru tuburi

Cod	Dimensiune	Pret €	Ambalare
034 0036	0-63		1/1

Lama de rezerva disponibila cod. 159 0067



1496R42

Foarfecă pentru tuburi

Cod	Dimensiune	Pret €	Ambalare
034 0022	0 - 42		1/10



1496

Foarfecă pentru tuburi

Cod	Dimensiune	Pret €	Ambalare
034 0030	14 - 16 - 18 - 20		1/1



1681RF

Capete de presare - RF profile - personalizat TIEMME

i Pentru accesorii vezi Cap. 08A

Cod	Dimensiune	Pret €	Ambalare
159 0095	12		1/1
159 0038	16		1/1
159 0129	17		1/1
159 0051	18		1/1
159 0039	20		1/1
159 0040	25		1/1
159 0042	32		1/1



1681MINIRF

Capete de presare - RF profile - personalizat TIEMME pentru presa MINI

i Pentru accesorii vezi Cap. 08A

Cod	Dimensiune	Pret €	Ambalare
159 0094	12		1/1
159 0032	16		1/1
159 0130	17		1/1
159 0052	18		1/1
159 0029	20		1/1
159 0033	25		1/1
159 0035	32		1/1

DIMENSIUNI DE GABARIT PENTRU CAPETELE DE PRESARE

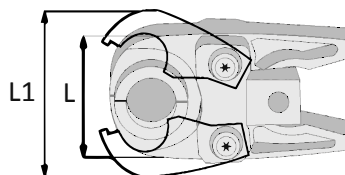





Cod	Dimensiune	L (mm)	L1 (mm)
159 0095	12	101	104
159 0038	16	101	104
159 0129	17	101	104
159 0051	18	101	104
159 0039	20	101	104
159 0040	25	101	115
159 0042	32	101	115
159 0094	12	101	101
159 0032	16	101	101
159 0130	17	101	101
159 0052	18	101	101
159 0029	20	101	101
159 0033	25	101	108
159 0035	32	101	108

L=falcile in pozitia inchis
L1=falcile in pozitia deschis



09 RACORDURI DE COMPRESIE CU O-RING DIN ALAMA PENTRU TUBURI DIN PE/PEHD/PEX

Seria 3460

3460W Racorduri de compresie cu o-ring pentru tuburi PE/PEHD/PEX - COMPACT		158
3460CR Racorduri de compresie cu o-ring pentru tuburi PE/PEHD/PEX		161
1460 Fitinguri de compresie cu o-ring-uri pentru tevi PE / PEHD / PEX de diametru mare		164
Accesorii		165

GHID DE COMPATIBILITATE

Seria	Tub potrivit	Stut de ranforsare obligatorie	Domeniu de aplicare	Caracteristici tehnice
3460W 3460CR	PE / PE-HD / PEX	-	• Apa rece	Pmax: 30 bar
3460W 3460CR	PE / PE-HD / PEX	Art. 1475	• Apa calda	Tmax: + 110 °C Pmax: 30 bar
1460	PE / PE-HD / PEX	-	• Apa rece	Pmax: 25 bar
1460	PE / PE-HD / PEX	Art. 1475	• Apa calda	Tmax: + 110 °C Pmax: 25 bar
3460CR	PE-HD	Art. 1475	• Gaz	Tmax: + 110 °C MOP5
3460W 3460CR 1460	Multistrat "AL-COBRAPEX"	Art. 1476	• Apa rece • Apa calda	Tmax: + 95 °C Pmax: 10 bar

Pentru detalii suplimentare consultati fisa tehnica



3460W

**3460W**

Racord drept M ISO 228

Cod	Dimensiune	Pret €	Ambalare
341 0013	20 x 1/2"		5/100
341 0003	25 x 3/4"		5/75
341 0001	32 x 1"		5/25
341 0006	40 x 1"1/4		2/20
341 0067	40 x 1"1/2		2/20
341 0040	50 x 1"1/2		2/10
341 0038	63 x 2"		1/10

**3462W**

Racord drept F ISO 228

Cod	Dimensiune	Pret €	Ambalare
341 0019	20 x 1/2"		5/100
341 0011	25 x 3/4"		5/50
341 0004	32 x 1"		5/25
341 0015	40 x 1"1/4		2/20
341 0068	40 x 1"1/2		2/20
341 0039	50 x 1"1/2		2/10
341 0037	63 x 2"		2/10

**3461W**

Racord drept dublu

Cod	Dimensiune	Pret €	Ambalare
341 0021	20 x 20		5/50
341 0008	25 x 25		5/25
341 0005	32 x 32		5/25
341 0016	40 x 40		2/10
341 0041	50 x 50		2/10
341 0042	63 x 63		2/10

**3464W**

Cot M conic ISO 228

Cod	Dimensiune	Pret €	Ambalare
341 0027	20 x 1/2"		5/75
341 0020	25 x 3/4"		5/50
341 0007	32 x 1"		5/25
341 0031	40 x 1"1/4		2/10
341 0045	50 x 1"1/2		2/10
341 0046	63 x 2"		1/5

**3465W**

Cot F ISO 228

Cod	Dimensiune	Pret €	Ambalare
341 0029	20 x 1/2"		5/50
341 0017	25 x 3/4"		5/50
341 0009	32 x 1"		5/25
341 0026	40 x 1"1/4		2/10
341 0047	50 x 1"1/2		2/10
341 0048	63 x 2"		1/5

**3463W**

Cot dublu

Cod	Dimensiune	Pret €	Ambalare
341 0023	20 x 20		5/50
341 0014	25 x 25		5/25
341 0002	32 x 32		5/20
341 0010	40 x 40		2/10
341 0043	50 x 50		2/10
341 0044	63 x 63		1/5



3460W

**3468W**

Teu M ISO 228

Cod	Dimensiune	Pret €	Ambalare
341 0034	20 x 1/2" x 20		5/50
341 0033	25 x 3/4" x 25		5/25
341 0035	32 x 1" x 32		5/15
341 0036	40 x 1"1/4 x 40		2/10
341 0051	50 x 1"1/2 x 50		2/10
341 0052	63 x 2" x 63		1/5

**3469W**

Teu F ISO 228

Cod	Dimensiune	Pret €	Ambalare
341 0030	20 x 1/2" x 20		5/25
341 0028	25 x 3/4" x 25		5/25
341 0024	32 x 1" x 32		5/15
341 0032	40 x 1"1/4 x 40		2/8
341 0053	50 x 1"1/2 x 50		2/10
341 0054	63 x 2" x 63		1/5

**3467W**

Teu

Cod	Dimensiune	Pret €	Ambalare
341 0025	20 x 20 x 20		5/25
341 0018	25 x 25 x 25		5/20
341 0012	32 x 32 x 32		5/10
341 0022	40 x 40 x 40		2/6
341 0049	50 x 50 x 50		2/10
341 0050	63 x 63 x 63		1/5

**3472W**

Piulita

Cod	Dimensiune	Pret €	Ambalare
341 0055	20		25/400
341 0056	25		25/300
341 0057	32		25/250
341 0058	40		10/200
341 0059	50		10/100
341 0060	63		5/50

**3473W**

Inel de etansare

Cod	Dimensiune	Pret €	Ambalare
341 0061	20		50/1200
341 0062	25		50/800
341 0063	32		50/500
341 0064	40		25/250
341 0065	50		25/200
341 0066	63		10/150

**3474**

Inel de compresie O-ring

Cod	Dimensiune	Pret €	Ambalare
340 0125	20		50/1200
340 0108	25		50/800
340 0110	32		25/500
340 0123	40		25/250
340 0122	50		25/200
340 0126	63		10/150

**3475**
O-ring

Cod	Dimensiune	Pret €	Ambalare
340 0118	20		50/1200
340 0116	25		50/800
340 0114	32		25/500
340 0120	40		25/250
340 0119	50		25/200
340 0121	63		10/150



3460CR

**3460CR**

Racord drept M conic ISO 7/EN 10226



Cod	Dimensiune	Pret €	Ambalare
340 0006	20 x 1/2"		5/100
340 0095	25 x 1/2"		5/75
340 0002	25 x 3/4"		5/75
340 0182	25 x 1"		5/75
340 0065	32 x 3/4"		5/25
340 0001	32 x 1"		5/40
340 0028	40 x 1"		2/20
340 0004	40 x 1"1/4		2/20
340 0186	40 x 1"1/2		2/20
340 0009	50 x 1"1/2		2/10
340 0007	63 x 2"		1/10

Noutati

**3462CR**

Racord drept F ISO 7/EN 10226



Cod	Dimensiune	Pret €	Ambalare
340 0016	20 x 1/2"		5/100
340 0094	25 x 1/2"		5/50
340 0010	25 x 3/4"		5/50
340 0183	25 x 1"		5/50
340 0089	32 x 3/4"		5/25
340 0005	32 x 1"		5/40
340 0188	32 x 1"1/4		5/40
340 0013	40 x 1"1/4		2/20
340 0187	40 x 1"1/2		2/20
340 0034	50 x 1"1/2		2/10
340 0189	50 x 2"		2/10
340 0026	63 x 2"		1/10

Noutati

**3461CR**

Racord drept dublu



Cod	Dimensiune	Pret €	Ambalare
340 0019	20 x 20		5/50
340 0011	25 x 25		5/40
340 0008	32 x 32		5/25
340 0029	40 x 40		2/10
340 0025	50 x 50		2/8
340 0015	63 x 63		1/8

**3471CR**

Prelungitor pentru reparatii



Cod	Dimensiune	Pret €	Ambalare
340 0071	32 x 32		5/20
340 0082	40 x 40		2/10
340 0073	50 x 50		2/8
340 0077	63 x 63		1/6

**3464CR**

Cot M conic ISO 7/EN 10226



Cod	Dimensiune	Pret €	Ambalare
340 0047	20 x 1/2"		5/75
340 0032	25 x 3/4"		5/50
340 0018	32 x 1"		5/25
340 0044	40 x 1"1/4		2/10
340 0053	50 x 1"1/2		2/8
340 0062	63 x 2"		1/4

3460CR

**3470CR**

Cot M 45° conic ISO 7/EN 10226



Cod	Dimensiune	Pret €	Ambalare
340 0102	25 x 3/4"		5/50
340 0099	32 x 1"		5/25
340 0115	40 x 1"1/4		2/10
340 0104	50 x 1"1/2		2/10
340 0103	63 x 2"		1/4

**3465CR**

Cot F ISO 7/EN 10226



Cod	Dimensiune	Pret €	Ambalare
340 0031	20 x 1/2"		5/50
340 0014	25 x 3/4"		5/50
340 0162	32 x 1"		5/25
340 0035	40 x 1"1/4		2/10
340 0051	50 x 1"1/2		2/8
340 0048	63 x 2"		1/5

**3466CR**

Cot F cu flansa ISO 7/EN 10226



Cod	Dimensiune	Pret €	Ambalare
340 0041	20 x 1/2"		5/50
340 0046	25 x 3/4"		5/25
340 0056	32 x 1"		5/20

**3463CR**

Cot dublu



Cod	Dimensiune	Pret €	Ambalare
340 0037	20 x 20		5/50
340 0012	25 x 25		5/25
340 0003	32 x 32		5/20
340 0017	40 x 40		2/10
340 0020	50 x 50		2/6
340 0024	63 x 63		1/4

**3468CR**

Teu M conic ISO 7/EN 10226



Cod	Dimensiune	Pret €	Ambalare
340 0088	20 x 1/2" x 20		5/50
340 0069	25 x 3/4" x 25		5/25
340 0068	32 x 1" x 32		5/15
340 0075	40 x 1"1/4 x 40		2/10
340 0086	50 x 1"1/2 x 50		2/8
340 0090	63 x 2" x 63		1/5

**3469CR**

Teu F ISO 7/EN 10226



Cod	Dimensiune	Pret €	Ambalare
340 0043	20 x 1/2" x 20		5/25
340 0030	25 x 3/4" x 25		5/25
340 0023	32 x 1" x 32		5/15
340 0045	40 x 1"1/4 x 40		2/8
340 0049	50 x 1"1/2 x 50		2/6
340 0058	63 x 2" x 63		1/3



3460CR

**3467CR**

Teu



Cod	Dimensiune	Pret €	Ambalare
340 0033	20 x 20 x 20		5/25
340 0021	25 x 25 x 25		5/20
340 0022	32 x 32 x 32		5/10
340 0050	40 x 40 x 40		2/6
340 0055	50 x 50 x 50		2/4
340 0060	63 x 63 x 63		1/2

**3472**

Piulita

Cod	Dimensiune	Pret €	Ambalare
340 0113	20		25/400
340 0112	25		25/300
340 0109	32		25/250
340 0097	40		10/200
340 0132	50		10/100
340 0124	63		5/50

**3473**

Inel de etansare

Cod	Dimensiune	Pret €	Ambalare
340 0111	20		50/1200
340 0100	25		50/800
340 0105	32		25/500
340 0106	40		25/250
340 0107	50		25/200
340 0117	63		10/150

**3474**

Inel de compresie O-ring

Cod	Dimensiune	Pret €	Ambalare
340 0125	20		50/1200
340 0108	25		50/800
340 0110	32		25/500
340 0123	40		25/250
340 0122	50		25/200
340 0126	63		10/150

**3475**

O-ring

Cod	Dimensiune	Pret €	Ambalare
340 0118	20		50/1200
340 0116	25		50/800
340 0114	32		25/500
340 0120	40		25/250
340 0119	50		25/200
340 0121	63		10/150



1460
Racord drept M ISO 228

Cod	Dimensiune	Pret €	Ambalare
340 0079	75 x 2"		1/10
340 0036	75 x 2"1/2		1/10
340 0078	90 x 2"1/2		1/6
340 0038	90 x 3"		1/6
340 0057	110 x 4"		1/3



1462
Racord drept F ISO 228

Cod	Dimensiune	Pret €	Ambalare
340 0054	75 x 2"1/2		1/10
340 0061	90 x 3"		1/6
340 0070	110 x 4"		1/3



1461
Racord drept dublu

Cod	Dimensiune	Pret €	Ambalare
340 0039	75 x 75		1/6
340 0042	90 x 90		1/6
340 0066	110 x 110		1/3



1464
Cot M ISO 228

Cod	Dimensiune	Pret €	Ambalare
340 0076	75 x 2"1/2		1/5
340 0128	90 x 3"		1/4



1465
Cot F ISO 228

Cod	Dimensiune	Pret €	Ambalare
340 0074	75 x 2"1/2		1/5
340 0129	90 x 3"		1/3



1463
Cot dublu

Cod	Dimensiune	Pret €	Ambalare
340 0059	75 x 75		1/4
340 0127	90 x 90		1/3



1468
Teu M ISO 228 F ISO 228

Cod	Dimensiune	Pret €	Ambalare
340 0130	75 x 2" M - 1"1/2 F		1/3
340 0131	90 x 2"1/2 M - 2" F		1/2



1469
Teu F ISO 228 M ISO 228

Cod	Dimensiune	Pret €	Ambalare
340 0085	75 x 2" F - 2"1/2 M		1/3
340 0084	90 x 2"1/2 F - 3" M		1/2

**1467**

Teu

Cod	Dimensiune	Pret €	Ambalare
340 0083	75 x 75 x 75		1/2
340 0081	90 x 90 x 90		1/1

**1475**

Stut de ranforsare

i "Dimensiune" se refera la dimensiunile tubului

Cod	Dimensiune	Pret €	Ambalare
340 0072	20 x 2,8		10/600
340 0040	25 x 3,0		10/350
340 0027	32 x 3,0		10/150
340 0052	40 x 3,7		5/50
340 0064	50 x 4,6		5/40
340 0063	63 x 5,8		1/20
340 0096	75 x 6,8		1/25
340 0098	90 x 8,2		1/20
340 0101	110 x 10		1/10

**1476**

Stut cu garnituri pentru tub multistrat

i "Dimensiune" se refera la dimensiunile tubului

i Accesoriu obligatoriu pentru utilizarea racordurilor Cobraring cu teava multistrat.

+ CU FUNCȚIE DIELECTRICĂ

Cod	Dimensiune	Pret €	Ambalare
340 0067	40 x 3,5		10/60
340 0080	50 x 4,0		5/30
340 0087	63 x 4,5		1/25
340 0178	75 x 5,0		1/20
340 0179	90 x 7,0		1/20

INSTRUCIUNI DE MONTAJ

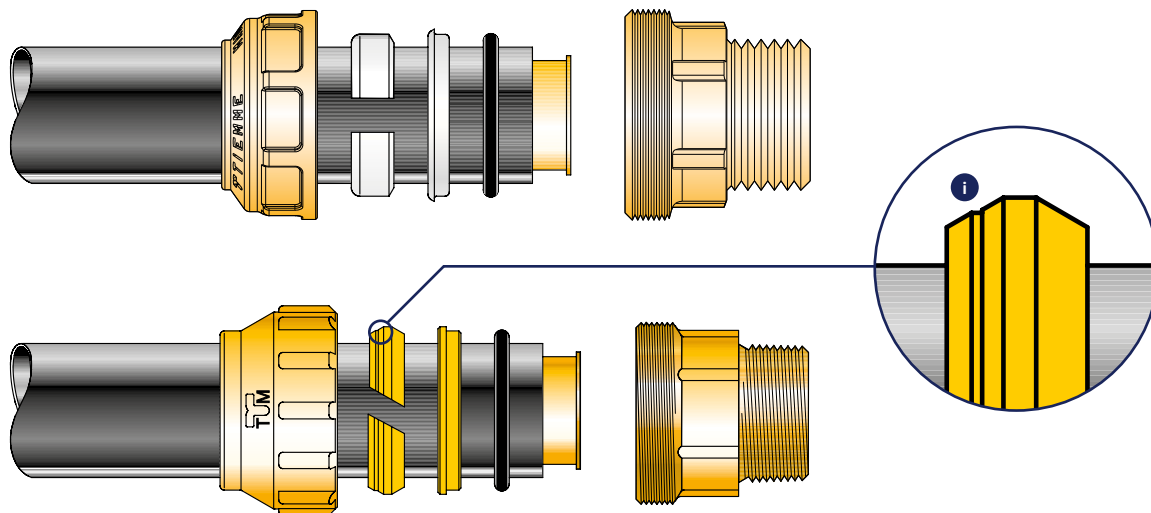
**TAIEREA TUBULUI**

Este recomandabilă tăierea tubului cu sculele recomandate care asigură o linie netedă și cât mai perpendiculară posibil pe axul tubului.

DEBAVURAREA ȘI CURĂȚIREA TUBULUI

Debavurați tubul interior și mai ales exterior pentru a elimina eventualele resturi și aschii.

INTRODUCEREA STUTULUI DE RANFORSARE ÎN TUB

Așezați stutul de ranforsare (art. 1475 sau art. 1476) la capătul tubului, până la capăt. Această operațiune este obligatorie în sistemul de aplicație și în combinație cu tipologia țevilor prezentate mai jos:

Domeniu de aplicare	Tipologie tub	Fitinguri „COBRA RING” potrivite pentru utilizare	Stut de ranforsare obligatoriu
Apa caldă	PE/ PE-HD/ PEX	Toate seriile	Art. 1475
Gaz metan sau GPL	PE-HD	seria 3460CR	Art. 1475
Apa rece sau caldă	Multistrat AL-COBRAPEX	Toate seriile	Art. 1476

MONTAJUL RACORDULUI

Introduceți piulița și inelul sectionat pe tub (mica incizie exterioară a inelului trebuie să fie neapărat în fața piuliței) și introduceți capătul țevii în fitting, având grijă să nu deplasați garnitura din locașul acesteia. Înșurubați piulița cu mâna strângând-o pe cât posibil și apoi, cu o cheie, aplicați numărul de strângeri conform indicațiilor din tabel, ținând cont că minimumul se referă la tubul ce are stutul de ranforsare introdus.

TABEL DE STRANGERE PIULITA - Nr. rotații

Tub	20	25	32	40	50	63
Nr. rotații	min. 1 - max 1,5	min. 1 - max 1,5	min. 1 - max 1,5	min. 1,5 - max 2	min. 1,5 - max 2	min. 1,5 - max 2



10 RACORDURI GENERALE DIN ALAMA

Seria 1500

Racorduri generale din alama "COMPACT"



168

Racorduri generale din alama



169

Racorduri generale din alama "STEEL BLOCK"



185





1550CT
Mufa dreapta F/F

Cod	Dimensiune	Pret €	Ambalare
150 0807	1/2" x 1/2"		10/100
150 0808	3/4" x 3/4"		10/100
150 0809	1" x 1"		5/50



1561CT
Cot M/F

Cod	Dimensiune	Pret €	Ambalare
150 0813	1/2" x 1/2"		10/100
150 0814	3/4" x 3/4"		5/50
150 0815	1" x 1"		5/25



1560CT
Cot F/F

Cod	Dimensiune	Pret €	Ambalare
150 0810	1/2" x 1/2"		10/100
150 0811	3/4" x 3/4"		5/75
150 0812	1" x 1"		5/50



1570CT
Teu F

Cod	Dimensiune	Pret €	Ambalare
150 0816	1/2" x 1/2" x 1/2"		10/100
150 0817	3/4" x 3/4" x 3/4"		5/50
150 0818	1" x 1" x 1"		5/25





1552
Niplu / Niplu redus

Cod	Dimensiune	Pret €	Ambalare
150 0354	1/4" x 1/4"		10/200
150 0306	3/8" x 1/4"		10/200
150 0218	3/8" x 3/8"		10/200
150 0395	1/2" x 1/4"		10/150
150 0074	1/2" x 3/8"		10/200
150 0002	1/2" x 1/2"		10/150
150 0012	3/4" x 1/2"		10/100
150 0008	3/4" x 3/4"		10/100
150 0089	1" x 1/2"		5/100
150 0022	1" x 3/4"		5/100
150 0001	1" x 1"		5/100
150 0044	1"1/4 x 1"		5/50
150 0025	1"1/4 x 1"1/4		5/50
150 1052	1"1/2 x 1"		5/50
150 0097	1"1/2 x 1"1/4		5/50
150 0088	1"1/2 x 1"1/2		5/25
150 0164	2" x 1"1/2		2/30
150 0081	2" x 2"		2/20
150 0486	2"1/2 x 1"1/2		2/20
150 0279	2"1/2 x 2"1/2		2/10
150 0375	3" x 3"		1/5
150 0487	4" x 4"		1/5

Noutati



1552C
Niplu / Niplu redus
Versiunea cromata

Cod	Dimensiune	Pret €	Ambalare
150 0624	3/8" x 1/4"		10/400
150 0502	3/8" x 3/8"		10/400
150 0406	1/2" x 3/8"		10/350
150 0234	1/2" x 1/2"		10/300
150 0447	3/4" x 1/2"		10/200
150 0435	3/4" x 3/4"		10/200
150 0613	1" x 1/2"		5/130
150 0555	1" x 3/4"		5/130
150 0500	1" x 1"		5/100



1552XL
Niplu XL

Cod	Dimensiune	Pret €	Ambalare
150 0803	1/2" x 1/2"		10/100
150 0841	3/4" x 3/4"		10/100
150 0842	1" x 1"		5/100



1552FD
Niplu fata dreapta (plana)

GARNITURA PLATA

Cod	Dimensiune	Pret €	Ambalare
471 0052	3/8" x 3/8"		25/100
471 0030	1/2" x 1/2"		10/100
471 0003	3/4" x 3/4"		10/100
471 0017	1" x 1"		5/100
471 0085	1"1/4 x 1"1/4		5/50
471 0086	1"1/2 x 1"1/2		2/30
471 0019	3/4" x 1/2"		10/100
471 0005	1" x 3/4"		5/100
471 0035	1" 1/4 x 1"		5/50
471 0039	1"1/2 x 1"1/4		5/50
471 0056	2" x 1"1/2		2/30



1552FDR
Niplu fata dreapta (plana) cu
O-RING

GARNITURA PLATA

Cod	Dimensiune	Pret €	Ambalare
471 0004	3/4" x 3/4" OR		10/100
471 0046	1" x 3/4" OR		5/100

1540

Bara M/M filetata



Cod	Dimensiune	Pret €	Ambalare
150 0198	1/2" x 50		1/50
150 0235	1/2" x 60		1/45
150 0312	1/2" x 70		1/40
150 0232	1/2" x 80		1/35
150 0311	1/2" x 90		1/30
150 0115	1/2" x 100		1/30
150 0155	1/2" x 150		1/15
150 0167	1/2" x 200		1/15
150 0274	1/2" x 250		1/15
150 0221	3/4" x 50		1/30
150 0246	3/4" x 60		1/30
150 0346	3/4" x 70		1/30
150 0212	3/4" x 80		1/20
150 0419	3/4" x 90		1/20
150 0112	3/4" x 100		1/20
150 0687	3/4" x 110		1/15
150 0152	3/4" x 150		1/10
150 0187	3/4" x 200		1/15
150 0300	3/4" x 250		1/8
150 0278	1" x 50		1/20
150 0255	1" x 60		1/20
150 0325	1" x 70		1/15
150 0302	1" x 80		1/15
150 0373	1" x 90		1/12
150 0126	1" x 100		1/12
150 0480	1" x 125		1/6
150 0560	1" x 130		1/6
150 0123	1" x 150		1/6
150 0159	1" x 200		1/10
150 0276	1" x 250		1/6
150 0626	1"1/4 x 50		1/20
150 0612	1"1/4 x 60		1/15
150 0631	1"1/4 x 70		1/15
150 0603	1"1/4 x 80		1/12
150 0632	1"1/4 x 90		1/12
150 0563	1"1/4 x 100		1/12
150 0629	1"1/4 x 125		1/6
150 0633	1"1/4 x 130		1/6
150 0584	1"1/4 x 150		1/6
150 0294	1"1/4 x 170		1/6
150 0516	1"1/4 x 200		1/6
150 0614	1"1/4 x 250		1/6

1540 - Bara M/M filetata

Cod	Dimensiune	Pret €	Ambalare
150 1046	1"1/2 x 100		1/10
150 1047	1"1/2 x 150		1/6
150 1048	1"1/2 x 200		1/5
150 1049	2" x 100		1/8
150 1050	2" x 150		1/5
150 1051	2" x 200		1/4

Noutati
La cerere

1540C

Bara M/M filetata cromat



Cod	Dimensiune	Pret €	Ambalare
150 0877	1/2" x 50		5/120
150 0878	1/2" x 60		5/120
150 0682	1/2" x 70		1/40
150 1025	1/2" x 100		1/30
150 1028	1/2" x 150		1/15
150 1023	3/4" x 50		1/30
150 1024	3/4" x 100		1/20
150 1027	3/4" x 150		1/10

1541

Bara filetata reglabila



Cu fir alungit

Cod	Dimensiune	Pret €	Ambalare
150 0286	1/2" x 100		1/30
150 0260	1/2" x 150		1/15
150 0343	1/2" x 200		1/15
150 0271	3/4" x 100		1/20
150 0257	3/4" x 150		1/10
150 0338	3/4" x 200		1/10
150 0254	1" x 100		1/12
150 0307	1" x 150		1/6
150 0350	1" x 200		1/10
150 0378	1" x 250		1/6

Disponibila la cerere versiunea nichelata



LISTA DE PRETURI



1531C
Prelungitor cromat M/M

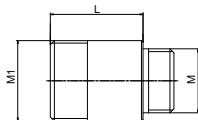

Cod	L x M → M1	Pret €	Ambalare
150 0913	16,5 x 3/8" 1/2"		5/450
150 0872	30 x 1/2" 3/4"		2/200



1550
Mufa dreapta F/F



Cod	Dimensiune	Pret €	Ambalare
150 0692	1/4" x 1/4"		10/200
150 0319	3/8" x 3/8"		10/150
150 0288	1/2" x 3/8"		10/100
150 0034	1/2" x 1/2"		10/100
150 0046	3/4" x 1/2"		10/100
150 0047	3/4" x 3/4"		10/100
150 0694	1" x 3/8"		10/100
150 0080	1" x 1/2"		10/100
150 0059	1" x 3/4"		10/100
150 0032	1" x 1"		5/50
150 0110	1"1/4 x 1"		5/50
150 0122	1"1/4 x 1"1/4		5/50
150 0131	1"1/2 x 1"1/2		2/40
150 1367	2" x 1"		2/20
150 0135	2" x 2"		2/20
150 0386	2"1/2 x 2"1/2		1/10
150 0511	4" x 4"		1/5

Noutati

Până la terminarea stocului



1550C
Mufa dreapta F/F
Versiunea cromata



Cod	Dimensiune	Pret €	Ambalare
150 0573	3/8" x 3/8"		10/400
150 0869	1/2" x 3/8"		10/100
150 0434	1/2" x 1/2"		10/250
150 0870	3/4" x 1/2"		10/100
150 0542	3/4" x 3/4"		10/150
150 0439	1" x 1/2"		10/150
150 0871	1" x 3/4"		10/100
150 0594	1" x 1"		5/70



1551
Prelungire redusa M/F

Cod	Dimensiune A x B	Pret €	Ambalare
150 0861	1/4" x 3/8"		10/100
150 0862	1/4" x 1/2"		10/100
150 0529	3/8" x 3/8"		10/100
150 0106	3/8" x 1/2"		10/100
150 0581	3/8" x 1"		10/100
150 0305	1/2" x 3/8"		10/100
150 0259	1/2" x 1/2"		10/100
150 0043	1/2" x 3/4"		10/100
150 0158	1/2" x 1"		10/100
150 1044	1/2" x 24(19 Fil)		10/100
150 0628	24(19 Fil) x 1/2"		10/100
150 0636	24(19 Fil) x 24(19 Fil)		10/100
150 0140	3/4" x 1/2"		10/100
150 0185	3/4" x 3/4"		10/100
150 0053	3/4" x 1"		10/100
150 0165	1" x 3/4"		10/100
150 0272	1" x 1"		10/100
150 0863	1" x 1"1/4		5/50
150 0864	1"1/4 x 1"1/2		2/30

Noutati

La cerere



1551C
Prelungire redusa M/F
Versiunea cromata

Cod	Dimensiune A x B	Pret €	Ambalare
150 0459	3/8" x 1/2"		10/300
150 0571	1/2" x 3/8"		10/300
150 0484	1/2" x 3/4"		10/200
150 0582	1/2" x 1"		10/150
150 1045	1/2" x 24(19 Fil)		10/250
150 0634	24(19 Fil) x 1/2"		10/250
150 0635	24(19 Fil) x 24(19 Fil)		10/200
150 0505	3/4" x 1/2"		10/250
150 0474	3/4" x 1"		10/130
150 0566	1" x 3/4"		10/120



1551FD
Racord drept M/F fata dreapta
(plana)

GARNITURA PLATA

Cod	Dimensiune A x B	Pret €	Ambalare
471 0078	3/4" x 1"		10/100



1220
Prelungitor M/F

i Disponibila la cerere versiunea cromata

Cod	Dimensiune	Pret €	Ambalare
150 0156	1/2" x 10 mm		25/400
150 0183	1/2" x 15 mm		25/350
150 0204	1/2" x 20 mm		10/300
150 0361	1/2" x 25 mm		10/250
150 0292	1/2" x 30 mm		10/200



1530
Prelungitor M/F

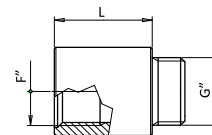

Cod	L x G → F	Pret €	Ambalare
150 0413	10 x 3/8" 3/8"		10/500
150 0482	15 x 3/8" 3/8"		10/450
150 0422	20 x 3/8" 3/8"		10/300
150 0471	30 x 3/8" 3/8"		10/250
150 0528	40 x 3/8" 3/8"		10/200
150 0497	50 x 3/8" 3/8"		10/200
150 0026	10 x 1/2" 1/2"		10/350
150 0031	15 x 1/2" 1/2"		10/300
150 0024	20 x 1/2" 1/2"		10/250
150 0100	25 x 1/2" 1/2"		10/200
150 0038	30 x 1/2" 1/2"		10/150
150 0079	40 x 1/2" 1/2"		5/120
150 0045	50 x 1/2" 1/2"		5/100
150 0145	80 x 1/2" 1/2"		5/80
150 0104	100 x 1/2" 1/2"		5/70
150 0333	150 x 1/2" 1/2"		5/50
150 0217	10 x 3/4" 3/4"		10/200
150 0211	15 x 3/4" 3/4"		10/200
150 0142	20 x 3/4" 3/4"		10/180
150 0301	25 x 3/4" 3/4"		5/150
150 0143	30 x 3/4" 3/4"		5/100
150 0236	40 x 3/4" 3/4"		5/100
150 0161	50 x 3/4" 3/4"		5/80
150 0321	80 x 3/4" 3/4"		5/50
150 0284	100 x 3/4" 3/4"		5/40
150 0390	10 x 1" 1"		10/150
150 0404	15 x 1" 1"		10/130
150 0268	20 x 1" 1"		10/120
150 0314	25 x 1" 1"		5/90
150 0256	30 x 1" 1"		5/80
150 0369	40 x 1" 1"		5/70
150 0245	50 x 1" 1"		5/60

**1530C**

Prelungitor cromat M/F

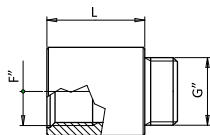

Cod	L x G → F	Pret €	Ambalare
150 0449	10 x 3/8" 3/8"		10/500
150 0458	15 x 3/8" 3/8"		10/450
150 0437	20 x 3/8" 3/8"		10/300
150 0442	30 x 3/8" 3/8"		10/250
150 0534	40 x 3/8" 3/8"		10/200
150 0519	50 x 3/8" 3/8"		10/200
150 0055	10 x 1/2" 1/2"		10/350
150 0069	15 x 1/2" 1/2"		10/300
150 0060	20 x 1/2" 1/2"		10/250
150 0170	25 x 1/2" 1/2"		10/200
150 0071	30 x 1/2" 1/2"		10/200
150 0113	40 x 1/2" 1/2"		5/120
150 0052	50 x 1/2" 1/2"		5/100
150 1037	60 x 1/2" 1/2"		5/100
150 1038	70 x 1/2" 1/2"		5/90
150 0184	80 x 1/2" 1/2"		5/80
150 1039	90 x 1/2" 1/2"		5/75
150 0188	100 x 1/2" 1/2"		5/70
150 0402	150 x 1/2" 1/2"		5/50
150 0335	10 x 3/4" 3/4"		10/200
150 0317	15 x 3/4" 3/4"		10/200
150 0269	20 x 3/4" 3/4"		10/180
150 0348	25 x 3/4" 3/4"		5/150
150 0240	30 x 3/4" 3/4"		5/100
150 0252	40 x 3/4" 3/4"		5/100
150 0139	50 x 3/4" 3/4"		5/80
150 1040	60 x 3/4" 3/4"		5/80
150 1041	70 x 3/4" 3/4"		5/70
150 0313	80 x 3/4" 3/4"		5/50
150 1042	90 x 3/4" 3/4"		5/50
150 0309	100 x 3/4" 3/4"		5/40
150 0504	10 x 1" 1"		10/150
150 0521	15 x 1" 1"		10/130
150 0425	20 x 1" 1"		10/120
150 0491	25 x 1" 1"		5/90
150 0405	30 x 1" 1"		5/80
150 0393	40 x 1" 1"		5/70
150 0328	50 x 1" 1"		5/60

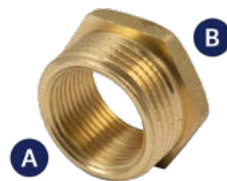
**1581**

Reductie M/F

Cod	Dimensiune A x B	Pret €	Ambalare
150 0455	1/4" x 1/8"		25/200
150 0380	3/8" x 1/8"		25/200
150 0308	3/8" x 1/4"		25/200
150 0506	1/2" x 1/8"		25/100
150 0134	1/2" x 1/4"		25/200
150 0093	1/2" x 3/8"		25/200
150 0209	3/4" x 3/8"		10/100
150 0013	3/4" x 1/2"		10/100
150 0367	1" x 1/4"		10/100
150 0330	1" x 3/8"		10/100
150 0030	1" x 1/2"		10/100
150 0016	1" x 3/4"		10/100
150 0462	1"1/4 x 1/2"		5/50
150 0098	1"1/4 x 3/4"		5/50
150 0028	1"1/4 x 1"		5/50
150 1010	1"1/2 x 1/2"		5/50
150 0190	1"1/2 x 3/4"		5/50
150 0075	1"1/2 x 1"		5/50
150 0082	1"1/2 x 1"1/4		5/50
150 0731	2" x 1"		2/40
150 0138	2" x 1"1/4		2/40
150 0130	2" x 1"1/2		2/40
150 0495	2"1/2 x 1"		2/30
150 0499	2"1/2 x 1"1/4		2/20
150 0421	2"1/2 x 1"1/2		2/20
150 0219	2"1/2 x 2"		2/30
150 0526	3" x 1"1/2		1/15
150 0324	3" x 2"		1/15
150 0398	3" x 2"1/2		1/18
150 0451	4" x 2"		1/10
150 0514	4" x 2"1/2		1/10
150 0518	4" x 3"		1/9



1581C
Reductie M/F Versiunea cromata

Cod	Dimensiune A x B	Pret €	Ambalare
150 0579	1/4" x 1/8"		25/1300
150 0588	3/8" x 1/8"		25/1000
150 0546	3/8" x 1/4"		25/1000
150 0585	1/2" x 1/8"		25/500
150 0553	1/2" x 1/4"		25/500
150 0262	1/2" x 3/8"		10/500
150 0400	3/4" x 1/2"		10/250
150 0558	1" x 1/2"		10/180
150 0539	1" x 3/4"		10/180
150 0564	1"1/4 x 1"		5/50
150 0611	1"1/2 x 1"1/4		5/70



1581FD
Reductie M/F fata dreapta

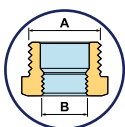

GARNITURA PLATA

Cod	Dimensiune A x B	Pret €	Ambalare
471 0050	1/2" x 3/8"		25/100
471 0022	3/4" x 1/2"		10/100
471 0079	1" x 1/2"		10/100
471 0012	1" x 3/4"		10/100
471 0038	1" 1/4 x 1"		5/50
471 0043	1"1/2 x 1" 1/4		5/50
471 0072	2" x 1"1/2		2/40



1582
Reductie inelara

Cod	Dimensiune	Pret €	Ambalare
150 0445	1/2" x 3/8"		25/300
150 0356	3/4" x 1/2"		25/200
150 0357	1" x 3/4"		10/100



1562
Cot M/M

Cod	Dimensiune	Pret €	Ambalare
150 0384	3/8" x 3/8"		10/100
150 0107	1/2" x 1/2"		10/100
150 0214	3/4" x 3/4"		10/100

ISO 228 cu fata dreapta



1560
Cot F/F

Cod	Dimensiune	Pret €	Ambalare
150 0298	3/8" x 3/8"		10/100
150 0508	1/2" x 3/8"		10/100
150 0018	1/2" x 1/2"		10/100
150 0149	3/4" x 1/2"		5/100
150 0015	3/4" x 3/4"		5/75
150 0111	1" x 3/4"		5/50
150 0017	1" x 1"		5/50
150 0340	1"1/4 x 1"		5/25
150 0067	1"1/4 x 1"1/4		5/25
150 0117	1"1/2 x 1"1/2		5/20
150 0121	2" x 2"		2/10
150 0515	4" x 4"		1/3

Până la terminarea stocului





1560C

Cot F/F

Versiunea cromata

Cod	Dimensiune	Pret €	Ambalare
150 0537	3/8" x 3/8"		10/200
150 0349	1/2" x 1/2"		10/180
150 0513	3/4" x 3/4"		5/80
150 0541	1" x 1"		5/50
150 0586	1"1/4 x 1"1/4		5/35



1567

Cot F/F cu flansa 2 gauri

Cod	Dimensiune	Pret €	Ambalare
150 0287	1/2" x 1/2"		10/100
150 0360	3/4" x 3/4"		5/50



1561

Cot M/F

Cod	Dimensiune	Pret €	Ambalare
	A x B		
150 0173	3/8" x 3/8"		10/100
150 0004	1/2" x 1/2"		10/100
150 0907	1/2" x 3/4"		5/50
150 0006	3/4" x 3/4"		5/50
150 0011	1" x 1"		5/25
150 0054	1"1/4 x 1"1/4		5/25
150 0119	1"1/2 x 1"1/2		5/25
150 0086	2" x 2"		2/10

1561

TABEL CU DIMENSIUNI

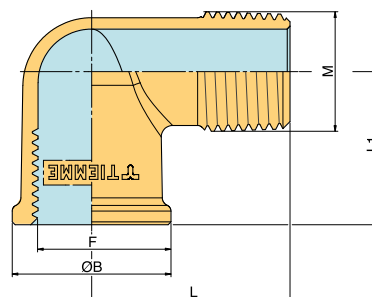

Cod	M	F	L	L1	ØB
150 0173	3/8"	3/8"	32	28,5	23
150 0004	1/2"	1/2"	35	27	28
150 0907	1/2"	3/4"	38	33,5	34
150 0006	3/4"	3/4"	39	31	34
150 0011	1"	1"	48	38	41,5
150 0054	1" 1/4	1" 1/4	44,5	42,5	51
150 0119	1" 1/2	1" 1/2	48,5	47,5	58
150 0086	2"	2"	59	55	70



1561C

Cot M/F. Versiunea cromata

Cod	Dimensiune	Pret €	Ambalare
150 0420	3/8" x 3/8"		10/200
150 0201	1/2" x 1/2"		10/150
150 0472	3/4" x 3/4"		5/60
150 0551	1" x 1"		5/40



1561DIN
Cot M/F seria masiva

Cod	Dimensiune	Pret €	Ambalare
150 0762	1/2" x 1/2"		10/100
150 0763	3/4" x 3/4"		5/50
150 0764	1" x 1"		5/25

1561DIN TABEL CU DIMENSIUNI

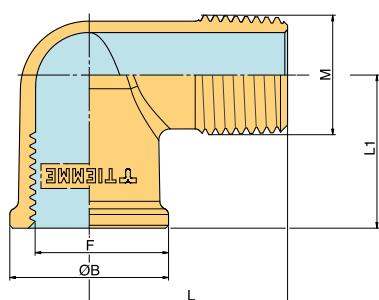

Cod	M	F	L	L 1	Ø B
150 0762	1/2"	1/2"	36	29	29
150 0763	3/4"	3/4"	42	33	35
150 0764	1"	1"	54	41	43



1563
Cot M/F cu flansa

Cod	Dimensiune	Pret €	Ambalare
150 0048	1/2" x 1/2"		10/100
150 0064	3/4" x 3/4"		5/50
150 0033	1" x 1"		5/25



1584C
Cot M/M fata dreapta cu flansa (cromată lucioasă)

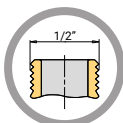

i Furnizat cu suruburi si diblu

Cod	Dimensiune	Pret €	Ambalare
150 0800	3/4" x 1/2"		1/100



1585C
Cot F/M fata dreapta cu flansa (cromată lucioasă)

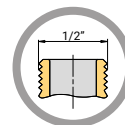

i Furnizat cu suruburi si diblu

Cod	Dimensiune	Pret €	Ambalare
150 0804	1/2" x 1/2"		1/100



1572
Teu M

Cod	Dimensiune	Pret €	Ambalare
150 0561	3/8" x 3/8" x 3/8"		10/100
471 0020	1/2" x 1/2" x 1/2"		10/100
150 0225	3/4" x 3/4" x 3/4"		5/75
150 0216	1" x 1" x 1"		5/50



1572FD
Teu masculin fata dreapta

+ GARNITURA PLATA

Cod	Dimensiune			Pret €	Ambalare
	1	2	3		
471 0020	1/2"	1/2"	1/2"		10/100
471 0040	3/4"	1/2"	1/2"		5/75
471 0041	3/4"	1/2"	3/4"		5/75
471 0060	3/4"	3/4"	1/2"		5/75
471 0011	3/4"	3/4"	3/4"		5/75
471 0049	1"	3/4"	1"		5/50
471 0084	1"	1"	1"		5/50





1570
Teu F

Cod	Dimensiune			Pret €	Ambalare
	1	2	3		
150 0275	3/8"	3/8"	3/8"		10/100
150 0533	1/2"	3/8"	1/2"		10/100
150 0003	1/2"	1/2"	1/2"		10/100
150 0544	3/4"	3/8"	3/4"		5/50
150 0049	3/4"	1/2"	3/4"		5/50
150 0915	3/4"	3/4"	1/2"		5/50
150 0009	3/4"	3/4"	3/4"		5/50
150 0037	1"	1/2"	1"		5/25
150 0087	1"	3/4"	1"		5/25
150 0005	1"	1"	1"		5/25
150 0441	1"1/4	1/2"	1"1/4		5/25
150 0446	1"1/4	3/4"	1"1/4		5/25
150 0719	1"1/4	1"	1"1/4		5/25
150 0029	1"1/4x1"1/4	1"1/4	1"1/4		5/20
150 0078	1"1/2x1"1/2	1"1/2	1"1/2		5/15
150 0120	2"	2"	2"		2/10
150 0481	4"	4"	4"		1/2

Până la terminarea stocului



1570C
Teu F
Versiunea cromata

Cod	Dimensiune			Pret €	Ambalare
	1	2	3		
150 0545	3/8"	3/8"	3/8"		10/150
150 0253	1/2"	1/2"	1/2"		10/110
150 0596	3/4"	1/2"	3/4"		5/50
150 0501	3/4"	3/4"	3/4"		5/50
150 0570	1"	1"	1"		5/30



1571
Teu F-M- F

Cod	Dimensiune	Pret €	Ambalare
150 0843	1/2" x 1/2" x 1/2"		10/100
150 0844	3/4" x 3/4" x 3/4"		5/50
150 0845	1" x 1" x 1"		5/25



1580
Cruce F

i Disponibila la cerere versiunea cromata

Cod	Dimensiune	Pret €	Ambalare
150 0103	1/2"		5/75
150 0065	3/4"		5/25
150 0091	1"		5/25
150 0182	1" 1/4		5/15
150 0299	1" 1/2		5/15
150 0414	2"		1/5



1555
Olandez cu O-RING M/F

i Disponibila la cerere versiunea cromata

Cod	Dimensiune	Pret €	Ambalare
150 0014	1/2" x 1/2"		5/100
150 0010	3/4" x 3/4"		5/50
150 0007	1" x 1"		5/50
150 0039	1"1/4 x 1"1/4		5/25
150 0023	1"1/2 x 1"1/2		2/20
150 0020	2" x 2"		2/10



1555U

Olandez cu **O-RING**
Temperatura de functionare-
15 ÷ 200 °C

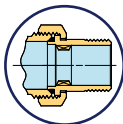

i Pentru utilizare cu apa, hidrocarburi si gaz (metan sau GPL)

Cod	Dimensiune	Pret €	Ambalare
150 0777	1/2" x 1/2"		5/100
150 0778	3/4" x 3/4"		5/50
150 0779	1" x 1"		5/50



1555R

Olandez cu **O-RING** si
preetansare pe filetul exterior
M/F

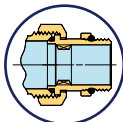

Cod	Dimensiune	Pret €	Ambalare
150 0523	3/4" x 3/4"		5/50
150 0283	1" x 1"		5/50
150 0524	1"1/4 x 1"1/4		5/25



1555CP

Olandez cu **GARNITURA PLATA**
M/F

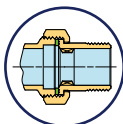

Cod	Dimensiune	Pret €	Ambalare
150 0708	3/8" x 3/8"		10/200
150 0203	1/2" x 1/2"		5/100
150 0181	3/4" x 3/4"		5/50
150 0213	1" x 1"		5/50
150 0320	1"1/4 x 1"1/4		5/25
150 0575	1"1/2 x 1"1/2		2/20
150 0556	2" x 2"		2/10



1565

Cot olandez M/F cu garnitura
O-RING

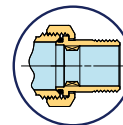

Cod	Dimensiune	Pret €	Ambalare
150 0410	3/8" x 3/8"		10/100
150 0105	1/2" x 1/2"		5/75
150 0063	3/4" x 3/4"		5/50
150 0068	1" x 1"		5/25
150 0194	1"1/4 x 1"1/4		2/20
150 0229	1"1/2 x 1"1/2		2/10
150 0281	2" x 2"		2/6



1565R

Cot olandez M/F cu garnitura
O-RING si preetansare pe filetul
exterior

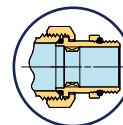

Cod	Dimensiune	Pret €	Ambalare
150 0618	3/4" x 3/4"		5/50
150 0591	1" x 1"		5/25
150 0620	1"1/4 x 1"1/4		2/20



1565CP

Cot olandez M/F cu **GARNITURA
PLATA**

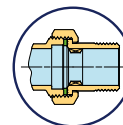

Cod	Dimensiune	Pret €	Ambalare
150 0401	1/2" x 1/2"		5/75
150 0359	3/4" x 3/4"		5/50
150 0381	1" x 1"		5/25
150 0465	1"1/4 x 1"1/4		2/20
150 0637	1"1/2 x 1"1/2		2/10
150 0638	2" x 2"		2/6





1557
Olandez alama F/F cu inchidere pe CON

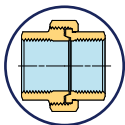

i Disponibila la cerere versiunea cromata

Cod	Dimensiune	Pret €	Ambalare
150 0186	1/2" x 1/2"		5/100
150 0199	3/4" x 3/4"		5/50
150 0177	1" x 1"		5/50
150 1054	1" 1/4 x 1" 1/4		5/25
150 1055	1" 1/2 x 1" 1/2		2/20
150 1056	2" x 2"		2/10

Noutati
La cerere



1557CP
Olandez cu GARNITURA PLATA F/F

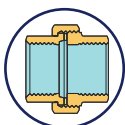

Cod	Dimensiune	Pret €	Ambalare
150 0358	1/2" x 1/2"		5/100
150 0383	3/4" x 3/4"		5/50
150 0403	1" x 1"		5/50
150 1060	1" 1/4 x 1" 1/4		5/25
150 1061	1" 1/2 x 1" 1/2		2/20
150 1062	2" x 2"		2/10

Noutati
La cerere



4746
Racord in unghi drept din trei bucati cu supapa dubla de blocare si izolare pentru vasul de expansiune.

Cod	Dimensiune	Pret €	Ambalare
470 0028	3/4" M - 3/4" F		5/50

4746 SECTIUNE

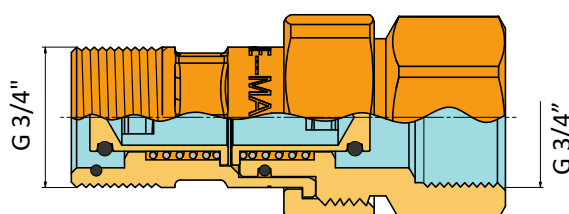

1513
Excentric cu ampatament 15 mm M/F

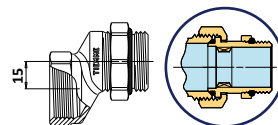

Cod	Dimensiune	Pret €	Ambalare
150 0444	1"		2/50



1514
Excentric cu ampatament 25 mm M/F

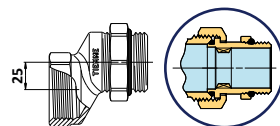

Cod	Dimensiune	Pret €	Ambalare
150 0672	1"		2/40



1521CP
Semiolandez cu GARNITURA PLATA

i Include: 1 stut, 1 piulita, 1 garnitura

Cod	Dimensiune	Pret €	Ambalare
150 0798	3/4" x 1/2"		5/100
150 0822	1" x 3/4"		5/100
150 0823	1" 1/4 x 1"		5/50
150 0890	1" 1/2 x 1" 1/4		5/50

NOU TATI



1521
Semiolandez

i Include: 1 stut, 1 piulita

Cod	Dimensiune	Pret €	Ambalare
150 0795	3/4" x 1/2"		5/100
150 0796	1" x 3/4"		5/100



1522

Set niplu + piulita pentru APOMETRU

Cod	Dimensiune	Pret €	Ambalare
150 0035	3/4" x 1/2"		1/100
150 0042	1" x 3/4"		1/60
150 0062	1"1/4 x 1"		1/30
150 0094	1"1/2 x 1"1/4		1/15
150 1063	2" x 1"1/2		1/30
150 1064	2"1/2 x 2"		1/14
150 0914	2"3/8 x 2"		1/5

Setul cuprinde: 2 nipluri, 2 piulite si 2 garnituri

Setul cuprinde: 1 nipluri, 1 piulite si 1 garnituri



1555SET

Set olandez din alama pentru pompa cu racorduri M/F si GARNITURA PLATA.

i Kitul contine: 2 stuturi, 2 piulite, 2 garnituri

Cod	Dim.	Atac pompa	Pret €	Ambalare
150 0825	1/2"	3/4"		1/50
150 0826	3/4"	1"		1/50
150 0827	1"	1"1/4		1/25
150 0578	1"1/4	1"1/2		1/20



1557SET

Set olandez din alama pentru pompa cu racorduri F/F si GARNITURA PLATA.

i Kitul contine: 2 stuturi, 2 piulite, 2 garnituri

Cod	Dim.	Atac pompa	Pret €	Ambalare
150 0906	1/2"	1"		1/50
150 0839	3/4"	1"1/4		1/25
150 0355	1"	1"1/2		1/20
150 0440	1"1/4	2"		1/10



1525N

Racord drept M nichelat cu piulita si garnitura plata

Cod	Dimensiune	Pret €	Ambalare
150 0891	1/2" x 1/2"		5/100
150 0893	3/4" x 3/4"		5/100
150 0897	1" x 1"		5/50
150 0898	1"1/4 x 1"1/4		2/50



1524

Racord drept f-f cu olandez si garnitura plata

Cod	Dimensiune	Pret €	Ambalare
150 0858	3/4"		1/100



1564FD

Cot M cu piulita libera si garnitura plata

+ GARNITURA PLATA

Cod	Dimensiune	Pret €	Ambalare
150 0520	3/4" x 3/4"		5/50



1583

Piulita

Cod	Dimensiune	Pret €	Ambalare
150 0125	1/2"		10/150
150 0191	3/4"		10/150
150 0261	1"		10/100
150 0310	1"1/4		10/100
150 0303	1"1/2		5/100
150 0332	2"		5/100





1878
Dop M

Cod	Dimensiune	Pret €	Ambalare
150 0273	3/8"		25/200
150 0040	1/2"		25/300
150 0019	3/4"		10/150
150 0077	1"		10/100
150 0222	1"1/4		5/100
150 0865	1"1/2		5/50
150 0866	2"		2/40

Disponibila la cerere versiunea cromata



1880
Dop F

Cod	Dimensiune	Pret €	Ambalare
150 0342	3/8"		25/200
150 0058	1/2"		25/200
150 0041	3/4"		10/100
150 0108	1"		10/100
150 0285	1"1/4		5/100
150 0327	1"1/2		5/60
150 0751	2"		2/50



1880C
Dop F pentru colectoare.
Versiunea cromata

Cod	Dimensiune	Pret €	Ambalare
150 0745	3/8"		25/800
150 0747	1/2"		25/600
150 0749	3/4"		10/100
150 0868	1"		10/100



1553FD
Niplu fata dreapta de legatura cu teava de cupru

GARNITURA PLATA

Cod	Dimensiune	Pret €	Ambalare
471 0057	∅ 15 - 3/4"		5/100
471 0016	∅ 22 - 3/4"		5/100
471 0036	∅ 22 - 1"		5/100



1507
Racord drept masculin pentru teava cupru curbata

Cod	Dimensiune	Pret €	Ambalare
111 0003	12 x 1/2"		10/100



1508
Racord drept feminin pentru teava cupru curbata

Cod	Dimensiune	Pret €	Ambalare
111 0004	12 x 1/2"		10/100

1507 - 1508 **EXEMPLU DE INSTALARE**

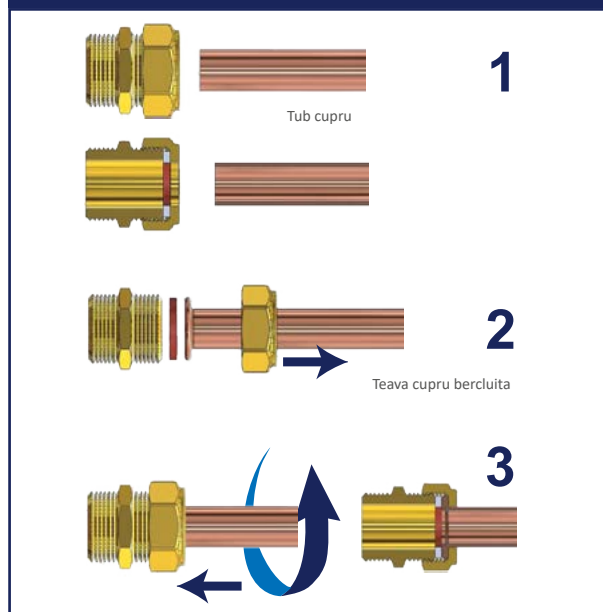



1511
Racord 3 cai pentru HIDROFOR

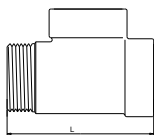

Cod	Dimensiune	Pret €	Ambalare
150 0147	L = 72 x 1"		5/50



1510
Racord 5 cai pentru HIDROFOR

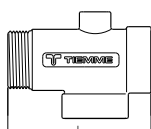

Cod	Dimensiune	Pret €	Ambalare
150 0128	L = 72 x 1"		5/40
150 0163	L = 82 x 1"		5/40
150 0132	L = 92 x 1"		5/35



1500
Portfurtun tip "Roma" cu filetul M

Cod	Dimensiune	Pret €	Ambalare
150 0473	6 x 1/4"		25/1000
150 0568	8 x 1/4"		25/1000
150 0507	10 x 1/4"		25/1000
150 0479	10 x 3/8"		25/600
150 0522	12 x 3/8"		25/600
150 0326	12 x 1/2"		10/350
150 0547	14 x 3/8"		10/400
150 0418	14 x 1/2"		10/300
150 0160	15 x 1/2"		10/300
150 0189	20 x 1/2"		10/250
150 0116	20 x 3/4"		10/200
150 0192	25 x 3/4"		10/150
150 0129	25 x 1"		10/100
150 0223	30 x 1"		10/80
150 0241	35 x 1"1/4		5/50
150 0239	40 x 1"1/2		5/40
150 0417	45 x 1"1/2		5/35
150 0215	50 x 2"		2/20

Disponibila la cerere versiunea nichelata



1501
Portfurtun tip "Roma" cu filetul F

Cod	Dimensiune	Pret €	Ambalare
150 0592	10 x 1/4"		25/600
150 0454	10 x 3/8"		25/600
150 0293	10 x 1/2"		25/500
150 0387	13 x 1/2"		10/400
150 0280	15 x 1/2"		10/300
150 0365	18 x 1/2"		10/300
150 0263	20 x 3/4"		10/200
150 0289	25 x 1"		10/100
150 0423	30 x 1"		10/80
150 0498	30 x 1"1/4		5/80
150 0496	35 x 1"1/4		5/75



1516
Racord drept prelungit pentru rezervor realizat prin matritare

Cod	Dimensiune	Pret €	Ambalare
150 0483	3/8"		5/40
150 0270	1/2"		5/40
150 0220	3/4"		5/25
150 0166	1"		5/15
150 0208	1"1/4		2/10
150 0295	1"1/2		1/8
150 0248	2"		1/5



1517
Racord de scurgere pentru rezervor

Cod	Dimensiune	Pret €	Ambalare
150 0469	1/2"		5/50
150 0411	3/4"		5/30
150 0371	1"		5/25
150 0443	1"1/4		2/10



LISTA DE PRETURI



1518
1519
Racord pentru rezervor cu dop
(1519 fara dop)

Cod	Dimensiune	Pret €	Ambalare
1518 - Cu dop			
150 0408	1/2"		5/50
150 0397	3/4"		5/30
150 0322	1"		5/25
150 0457	1"1/4		2/10
1519 - Fara dop			
150 0153	1/2"		5/50
150 0179	3/4"		5/30
150 0176	1"		5/25
150 0231	1"1/4		2/10



1520
Cot pentru rezervor

Cod	Dimensiune	Pret €	Ambalare
150 0460	1/2"		5/25
150 0476	3/4"		5/20
150 0463	1"		2/12



1502
Racord drept pentru pompa

Cod	Dimensiune	Pret €	Ambalare
150 0388	15 x 1/2"		5/40
150 0323	20 x 3/4"		5/30
150 0329	25 x 1"		5/30
150 0407	30 x 1"		5/20
150 0466	30 x 1"1/4		3/15
150 0452	35 x 1"1/4		3/15
150 0394	40 x 1"1/2		2/12
150 0370	50 x 2"		1/5
150 0424	60 x 2"		1/3
150 0587	60 x 2"1/2		1/3



1503
Racord cot pentru pompa

Cod	Dimensiune	Pret €	Ambalare
150 0490	15 x 1/2"		5/40
150 0494	20 x 3/4"		5/20
150 0492	25 x 1"		2/20
150 0548	30 x 1"		1/15
150 0600	30 x 1"1/4		1/10
150 0593	35 x 1"1/4		1/10
150 0554	40 x 1"1/2		1/6
150 0538	50 x 2"		1/4
150 0610	60 x 2"		1/2
150 0630	60 x 2"1/2		1/2



1504
Racord din 3 piese pentru pompa

Cod	Dimensiune	Pret €	Ambalare
150 0531	15		5/40
150 0509	18		5/40
150 0467	20		5/30
150 0438	25		5/30
150 0567	35		2/10
150 0590	40		1/8
150 0605	45		1/5
150 0540	50		1/5

Până la terminarea stocului



R616NAS

Bandă din teflon

Cod	Dimensiune	Pret €	Ambalare
150 0786	12mm x 12m x 0,076mm		10/150



R616

Teflon lichid

Cod	Dimensiune	Pret €	Ambalare
056 0002	100 gr.		1/50





1590
Racord drept M



Cod	Dimensiune	Pret €	Ambalare
150 0118	3/8"		5/120
150 0021	1/2"		2/60
150 0051	3/4"		2/50
150 0056	1"		2/34
150 0092	1"1/4		1/20
150 0090	1"1/2		1/15
150 0085	2"		1/10



1592
Racord drept F



Cod	Dimensiune	Pret €	Ambalare
150 0114	3/8"		5/120
150 0027	1/2"		2/60
150 0050	3/4"		2/50
150 0066	1"		2/34
150 0109	1"1/4		1/20
150 0099	1"1/2		1/15
150 0102	2"		1/10



1591
Racord drept dublu



Cod	Dimensiune	Pret €	Ambalare
150 0389	3/8"		5/80
150 0242	1/2"		2/50
150 0237	3/4"		2/40
150 0226	1"		2/26
150 0282	1"1/4		1/15
150 0210	1"1/2		1/15
150 0195	2"		1/10

**1590 - 1591 -
1592**

DESCRIERE

Racordurile Art. 1590 - 1591 - 1592 sunt destinate reparatiilor simple, sigure si rapide a tevii din otel; nu mai este necesara operatia de filetare a tevii si sunt de tip culisant. Aceste racorduri au in componenta un inel de etansare conic. Nu este recomandata folosirea racordurilor cu substante acide, alcaline, acetone, eteri, hidrocarburi, lichid de frana, aburi etc.

- Temperatura de lucru: -25 +100 °C
- Presiune maxima: 20 bar



11 COLECTOARE DE DISTRIBUTIE



Colectoare de distributie "NINO" cu robineti cu sfera		188
Colectoare de distributie "MAXIMA" cu robineti de oprire		190
Colectoare de distributie "MAXIMA CORNER" cu robineti de oprire		193
Colectoare de distributie "MAXIMA VERTI" cu robineti de oprire		194
Colectoare universale premontate in casete "SANIBOX"		197
Colectoare de distributie "LINEARE"		199
Colector de distributie stantat, model "FLOOR" cu filet M/F fazat		201
Colector de distributie model "INDUSTRIAL FLOOR" cu filet M/F fazat		202
Accesorii pentru colectoare		203
Casete si seturi de prindere		212
Robineti cu sfera, motorizati		215
Adaptoare pentru colectoare		219

Utilizare cu caseta 1810, 1812, 1910P, 1920-1930 și 1939-1940 (pag. 212)



1822 1832

Colector "NINO" din alama CW617N cu robineti cu sfera. Interaxa 36 mm și iesiri 1/2" x 16

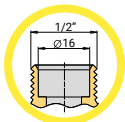

Cod	Diametru	Cai	Dimens.	Pret €	Ambalare
182 0002	3/4"G	2	1/2"(ø16)		4/32
182 0001	3/4"G	3	1/2"(ø16)		4/16
182 0016	3/4"G	4	1/2"(ø16)		4/16
182 0006	1"G	2	1/2"(ø16)		4/32
182 0005	1"G	3	1/2"(ø16)		4/16
Versiunea nichelata					
182 0004	3/4"G	2	1/2"(ø16)		4/32
182 0003	3/4"G	3	1/2"(ø16)		4/16
182 0049	3/4"G	4	1/2"(ø16)		4/16
182 0010	1"G	2	1/2"(ø16)		4/32
182 0007	1"G	3	1/2"(ø16)		4/16



1822RCP 1832RCP

Colector "NINO" din alama CW617N cu robineti cu sfera. Interaxa 36 mm și iesiri 1/2" garnitura plata. Filet fazat cu O-ring

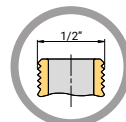

CU FILET M/F FAZATE

Cod	Diametru	Cai	Dimens.	Pret €	Ambalare
maneta tip fluture albastra					
182 0072	3/4"G	2	1/2"		4/32
182 0073	3/4"G	3	1/2"		4/16
182 0074	3/4"G	4	1/2"		4/16
182 0078	1"G	2	1/2"		4/32
182 0079	1"G	3	1/2"		4/16
maneta tip fluture rosie					
182 0075	3/4"G	2	1/2"		4/32
182 0076	3/4"G	3	1/2"		4/16
182 0077	3/4"G	4	1/2"		4/16
182 0080	1"G	2	1/2"		4/32
182 0081	1"G	3	1/2"		4/16

1822-1832 GHID DE CONEXIUNI

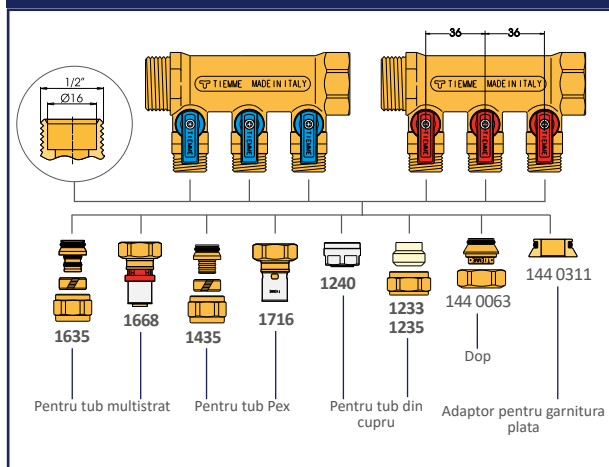

1822RCP 1832RCP GHID DE CONEXIUNI

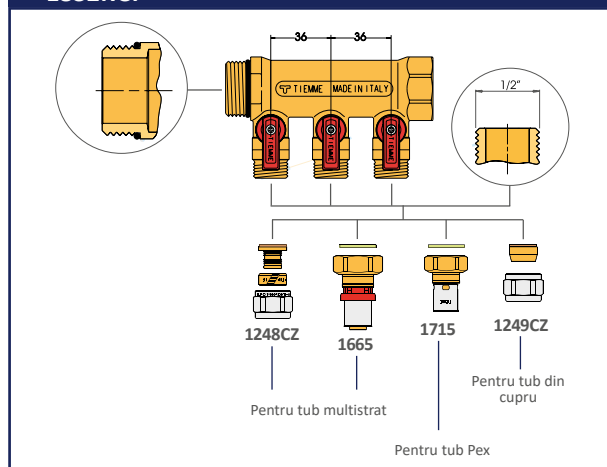

Vezi pagina cu tabelul de rotatii ale piulitei de la sfarsitul capitolului



Utilizare cu caseta 1810, 1812, 1910P, 1920-1930 și 1939-1940 (pag. 212)

**1822RCP50**

Colector "NINO" din alama CW617N cu robineti cu sfera. Interaxa 50 mm și iesiri 1/2" garnitura plata. Filet fazat cu O-ring

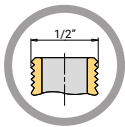

CU FILET M/F FAZATE

Cod	Diametru	Cai	Dimens.	Pret €	Ambalare
maneta tip fluture albastra					
182 0104	3/4"G	2	1/2"		4/32
182 0105	3/4"G	3	1/2"		4/16
182 0106	3/4"G	4	1/2"		4/16
maneta tip fluture rosie					
182 0107	3/4"G	2	1/2"		4/32
182 0108	3/4"G	3	1/2"		4/16
182 0109	3/4"G	4	1/2"		4/16

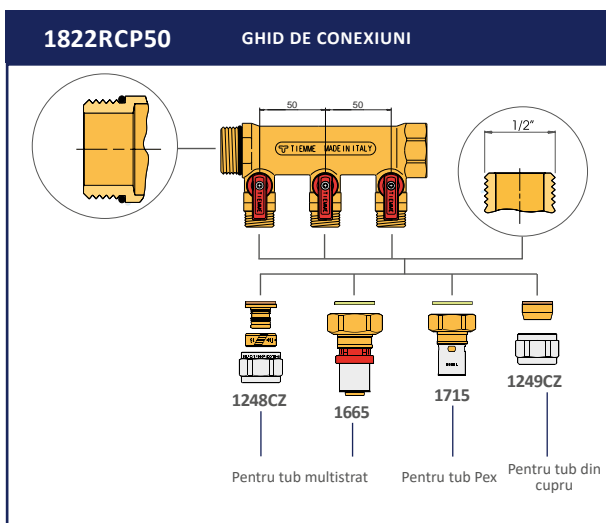

Vezi pagina cu tabelul de rotatii ale piulitei de la sfarsitul capitolului

Utilizare cu caseta 1810, 1812, 1920-1930 și 1939-1940 (pag. 212)



1866K 1868K

Colector cu robineti de oprire "MAXIMA" din alama CW617N cromata. **Interaxa 36 mm** și iesiri 1/2"x16. Filet fazat cu O-ring.

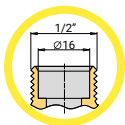

+ CU FILET M/F FAZATE

+ Se livrează cu etichete de marcare a tipului de consumator

Cod	Diametru	Cai	Dimens.	Pret €	Ambalare
186 0163	3/4"G	1	1/2"(ø16)		4/32
186 0008	3/4"G	2	1/2"(ø16)		4/32
186 0005	3/4"G	3	1/2"(ø16)		4/16
186 0004	3/4"G	4	1/2"(ø16)		4/16
186 0010	3/4"G	5	1/2"(ø16)		4/16
186 0083	3/4"G	6	1/2"(ø16)		4/12
186 0164	1"G	1	1/2"(ø16)		4/32
186 0022	1"G	2	1/2"(ø16)		4/32
186 0021	1"G	3	1/2"(ø16)		4/16
186 0020	1"G	4	1/2"(ø16)		4/16
186 0028	1" G	5	1/2"(ø16)		4/16
186 0084	1" G	6	1/2"(ø16)		4/12



1868KCOPPIA

Set colectoare premontate cu robineti de oprire, seria "MAXIMA", din alama CW617 N cu **interaxa 36 mm** și iesiri 1/2" x 16

Filet fazat cu O-ring, versiunea Cromata

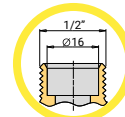

Cod	Diametru	Cai	Dimens.	Pret €	Ambalare
186 0082	1"G	4	1/2"(ø16)		1/1
186 0048	1"G	5	1/2"(ø16)		1/1
186 0049	1"G	6	1/2"(ø16)		1/1
186 0050	1"G	7	1/2"(ø16)		1/1
186 0051	1"G	8	1/2"(ø16)		1/1
186 0052	1"G	9	1/2"(ø16)		1/1
186 0053	1"G	10	1/2"(ø16)		1/1

1866K-1868K 1868KCOPPIA

GHID DE CONEXIUNI

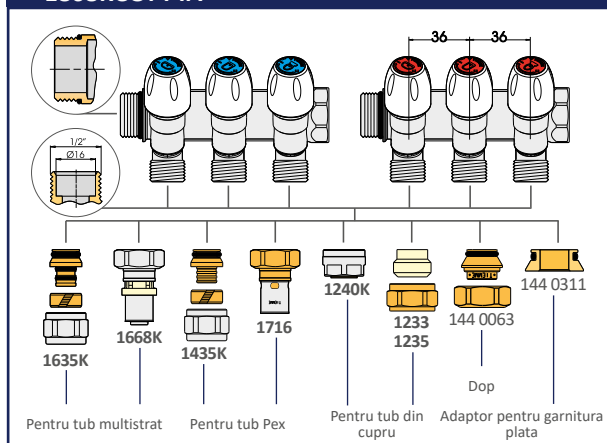

i Vezi pagina cu tabelul de rotatii ale piulței de la sfarsitul capitolului



LISTA DE PREȚURI

Utilizare cu caseta 1810, 1812, 1920-1930 și 1939-1940 (pag. 212)

NOUȚĂȚI



1866CP

Colectoare MAXIMA din alama CW617N galbena cu iesiri 1/2" garnitura plata. Interaxa 36 mm. Filet fazat cu O-ring

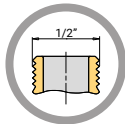

+ CU FILET M/F FAZATE

+ Se livreaza cu etichete de marcare a tipului de consumator

Cod	Diametru	Cai	Dimens.	Pret €	Ambalare
186 0200	3/4"G	2	1/2"		4/32
186 0201	3/4"G	3	1/2"		4/16
186 0202	3/4"G	4	1/2"		4/16



1877K36

Colector cu robineti de oprire MAXIMA din alama cromată CW617N cu interax 36 mm și conexiuni filetate 24x19 fil Ø18. Filet fazat cu garnitura.

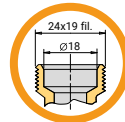

+ CU FILET M/F FAZATE

+ Se livreaza cu etichete de marcare a tipului de consumator

Cod	Diametru	Cai	Dimens.	Pret €	Ambalare
186 0023	3/4"G	2	24 x 19 fil (Ø18)		1/25
186 0018	3/4"G	3	24 x 19 fil (Ø18)		1/25
186 0014	3/4"G	4	24 x 19 fil (Ø18)		1/25
186 0016	3/4"G	5	24 x 19 fil (Ø18)		1/20
186 0085	3/4"G	6	24 x 19 fil (Ø18)		1/15
186 0006	1"G	2	24 x 19 fil (Ø18)		1/25
186 0003	1"G	3	24 x 19 fil (Ø18)		1/25
186 0002	1"G	4	24 x 19 fil (Ø18)		1/20
186 0001	1" G	5	24 x 19 fil (Ø18)		1/20
186 0086	1" G	6	24 x 19 fil (Ø18)		1/15
186 0138	1"1/4G	2	24 x 19 fil (Ø18)		1/20
186 0139	1"1/4G	3	24 x 19 fil (Ø18)		1/20
186 0140	1"1/4G	4	24 x 19 fil (Ø18)		1/15
186 0141	1"1/4G	5	24 x 19 fil (Ø18)		1/15
186 0142	1"1/4G	6	24 x 19 fil (Ø18)		1/10

1866CP

GHID DE CONEXIUNI

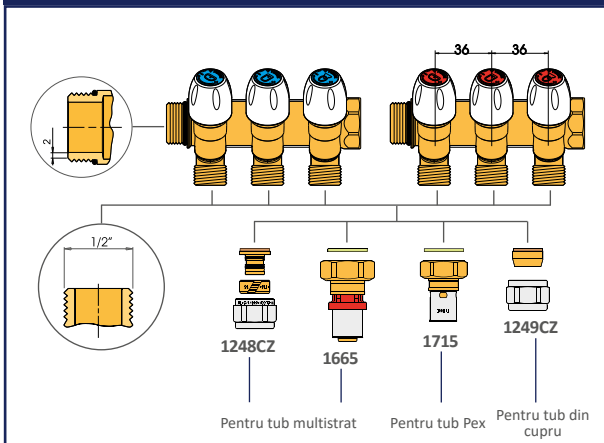

1877K36

GHID DE CONEXIUNI

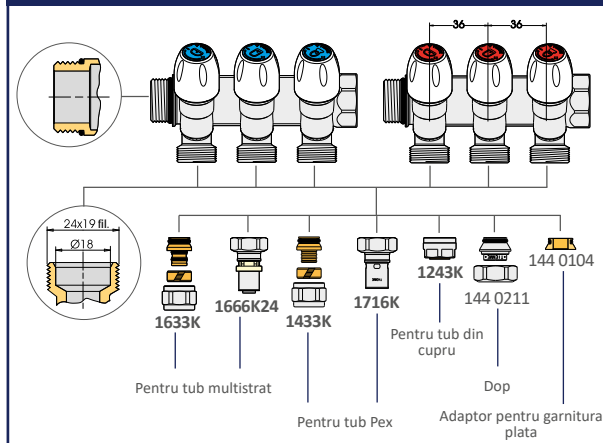

Utilizare cu caseta 1810, 1812, 1920-1930 și 1939-1940 (pag. 212)



1877K50

Colector cu robineti de oprire "MAXIMA" din alama CW617N cromata. **Interaxa 50 mm** și iesiri 3/4"x18 (EUROCONO). Filet fazat cu O-ring.

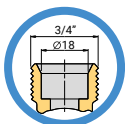

+ CU FILET M/F FAZATE

+ Se livreaza cu etichete de marcare a tipului de consumator

Cod	Diametru	Cai	Dimens.	Pret €	Ambalare
186 0026	3/4"	2	3/4"(ø18)		4/16
186 0011	3/4"	3	3/4"(ø18)		4/16
186 0015	3/4"	4	3/4"(ø18)		4/16
186 0024	1"	2	3/4"(ø18)		4/16
186 0013	1"	3	3/4"(ø18)		4/16
186 0019	1"	4	3/4"(ø18)		4/16



1877K50

Colector cu robineti de oprire "MAXIMA" din alama cromată CW617N cu **interax 50 mm** și conexiuni filetate 24x19 fil ø18. Filet fazat cu garnitura.

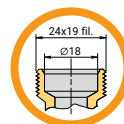

+ CU FILET M/F FAZATE

+ Se livreaza cu etichete de marcare a tipului de consumator

Cod	Diametru	Cai	Dimens.	Pret €	Ambalare
186 0043	3/4"	2	24 x 19 fil (ø18)		1/25
186 0041	3/4"	3	24 x 19 fil (ø18)		1/25
186 0044	3/4"	4	24 x 19 fil (ø18)		1/20
186 0032	1"	2	24 x 19 fil (ø18)		1/25
186 0031	1"	3	24 x 19 fil (ø18)		1/25
186 0029	1"	4	24 x 19 fil (ø18)		1/20

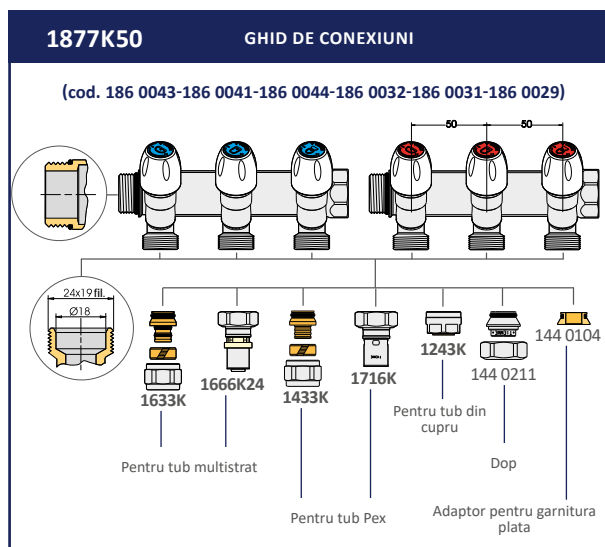
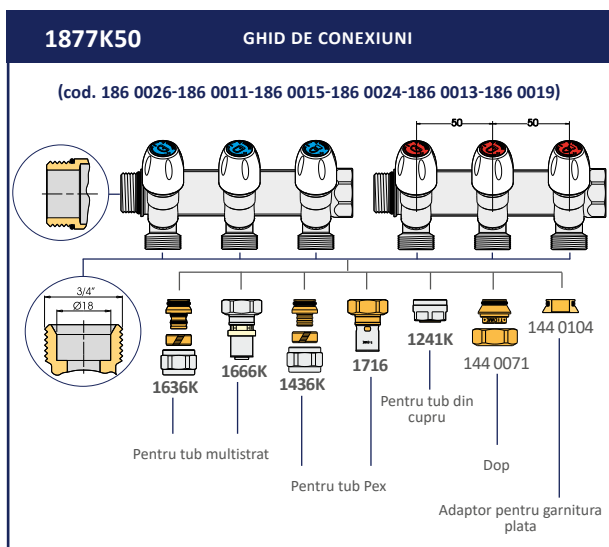

i Vezi pagina cu tabelul de rotatii ale piulitei de la sfarsitul capitolului



Utilizare cu caseta 1810, 1812, 1920-1930 și 1939-1940 (pag. 212)



1871K

Colector cu robineti de oprire "MAXIMA CORNER" din alama CW617N cromata. Interaxa 50 mm. Filet fazat cu O-ring

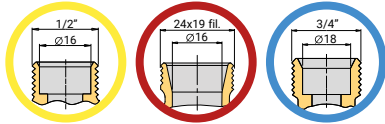

+ CU FILET M/F FAZATE

Cod	Diametru	Cai	Dimens.	Pret €	Ambalare
185 0001	3/4"G	2	1/2"(Ø16)		1/10
185 0002	3/4"G	3	1/2"(Ø16)		1/8
185 0003	3/4"G	4	1/2"(Ø16)		1/8
185 0010	1"G	2	1/2"(Ø16)		1/10
185 0011	1"G	3	1/2"(Ø16)		1/8
185 0012	1"G	4	1/2"(Ø16)		1/8
185 0004	3/4"G	2	24 x 19 fil (Ø16)		1/10
185 0005	3/4"G	3	24 x 19 fil (Ø16)		1/8
185 0006	3/4"G	4	24 x 19 fil (Ø16)		1/8
185 0013	1"G	2	24 x 19 fil (Ø16)		1/10
185 0014	1"G	3	24 x 19 fil (Ø16)		1/8
185 0015	1"G	4	24 x 19 fil (Ø16)		1/8
185 0007	3/4"G	2	3/4"(Ø18)		1/10
185 0008	3/4"G	3	3/4"(Ø18)		1/8
185 0009	3/4"G	4	3/4"(Ø18)		1/8
185 0016	1"G	2	3/4"(Ø18)		1/10
185 0017	1"G	3	3/4"(Ø18)		1/8
185 0018	1"G	4	3/4"(Ø18)		1/8



1632K

Adaptor pentru tub multistrat, pentru conexiuni 24x19fil (Ø16). Versiunea cromata

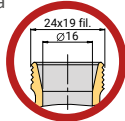

Cod	Dimensiune	Pret €	Ambalare
144 0256	16 x 2,0 - 24 x 19 fil (Ø16)		1/150
144 0257	20 x 2,0 - 24 x 19 fil (Ø16)		1/150

1871K

GHID DE CONEXIUNI

(Cod. 185 0001-185 0002-185 0003-185 0010-185 0011-185 0012)

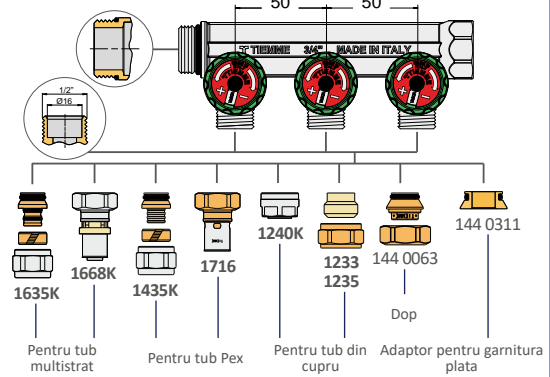

1871K

GHID DE CONEXIUNI

(Cod. 185 0004-185 0005-185 0006-185 0013-185 0014-185 0015)

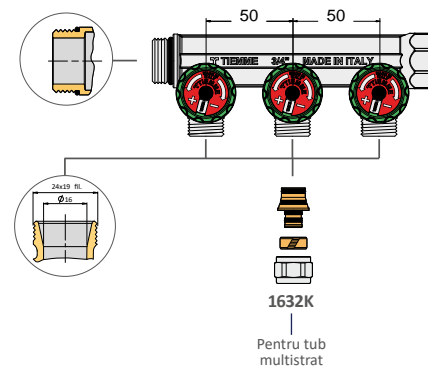

1871K

GHID DE CONEXIUNI

(Cod. 185 0007-185 0008-185 0009-185 0016-185 0017-185 0018)

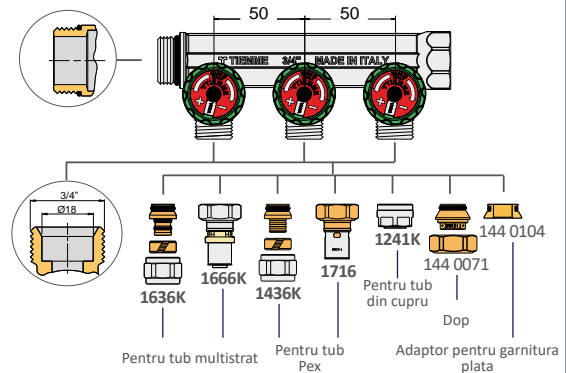

i Vezi pagina cu tabelul de rotatii ale piulței de la sfarsitul capitolului

Utilizare cu caseta 1810, 1812, 1910P, 1920-1930 și 1939-1940 (pag. 212)



1876K50

Colector cu robineti de oprire "MAXIMA VERTI" din alama CW617N cromata. **Interaxa 50 mm** si iesiri 3/4" fil Ø18. Filet fazat cu O-ring.

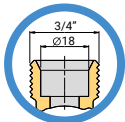

+ CU FILET M/F FAZATE

+ Se livreaza cu etichete de marcare a tipului de consumator

Cod	Diametru	Cai	Dimens.	Pret €	Ambalare
187 0009	1"G	2	3/4"(Ø18)		1/25
187 0010	1"G	3	3/4"(Ø18)		1/25
187 0011	1"G	4	3/4"(Ø18)		1/20



1876K

Colector cu robineti de oprire "MAXIMA VERTI" din alama CW617N cromata. **Interaxa 36 mm** si iesiri 24x19 fil Ø18. Filet fazat cu O-ring.

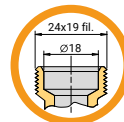

+ CU FILET M/F FAZATE

+ Se livreaza cu etichete de marcare a tipului de consumator

Cod	Diametru	Cai	Dimens.	Pret €	Ambalare
187 0008	3/4"G	2	24 x 19 fil (Ø18)		1/25
187 0007	3/4"G	3	24 x 19 fil (Ø18)		1/25
187 0006	3/4"G	4	24 x 19 fil (Ø18)		1/25
187 0005	3/4"G	5	24 x 19 fil (Ø18)		1/25
187 0004	1"G	2	24 x 19 fil (Ø18)		1/25
187 0001	1"G	3	24 x 19 fil (Ø18)		1/25
187 0002	1"G	4	24 x 19 fil (Ø18)		1/25
187 0003	1"G	5	24 x 19 fil (Ø18)		1/20

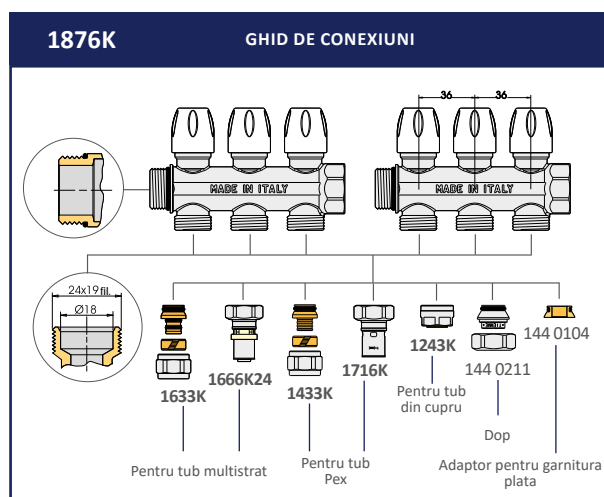
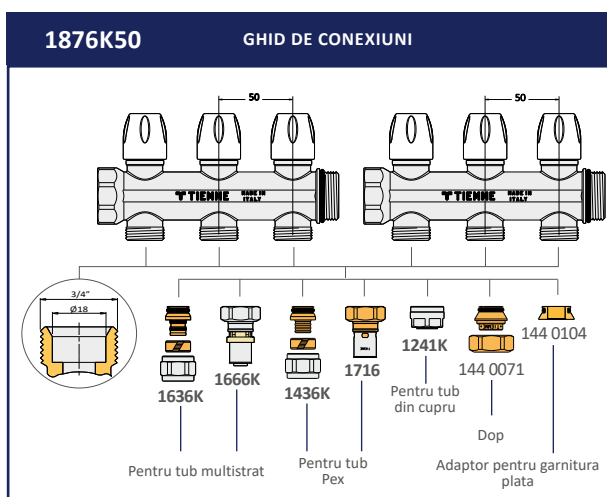

i Vezi pagina cu tabelul de rotatii ale piulitei de la sfarsitul capitoului





H9302

O-Ring pentru etansare

Cod	Dimensiune	Pret €	Ambalare
040 0109	3/4"		50/600
040 0110	1"		50/500

GHID DE ACCESORII PENTRU COLECTOARELE CU FILET FAZAT MASCULIN/FEMININ

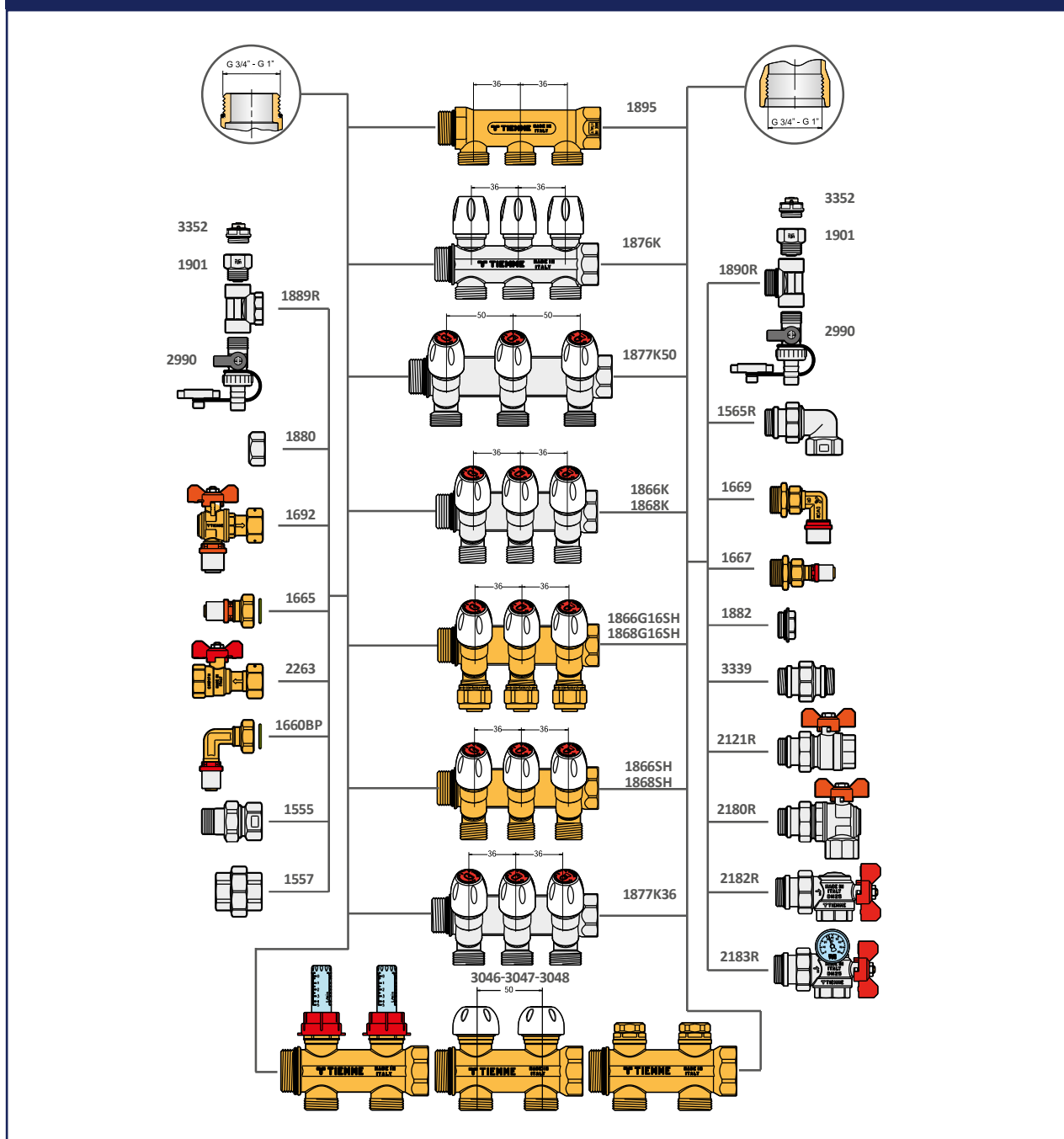

EXEMPLU DE MONTAJ PENTRU COLECTOARE CU FILET FAZAT MASCULIN/FEMININ

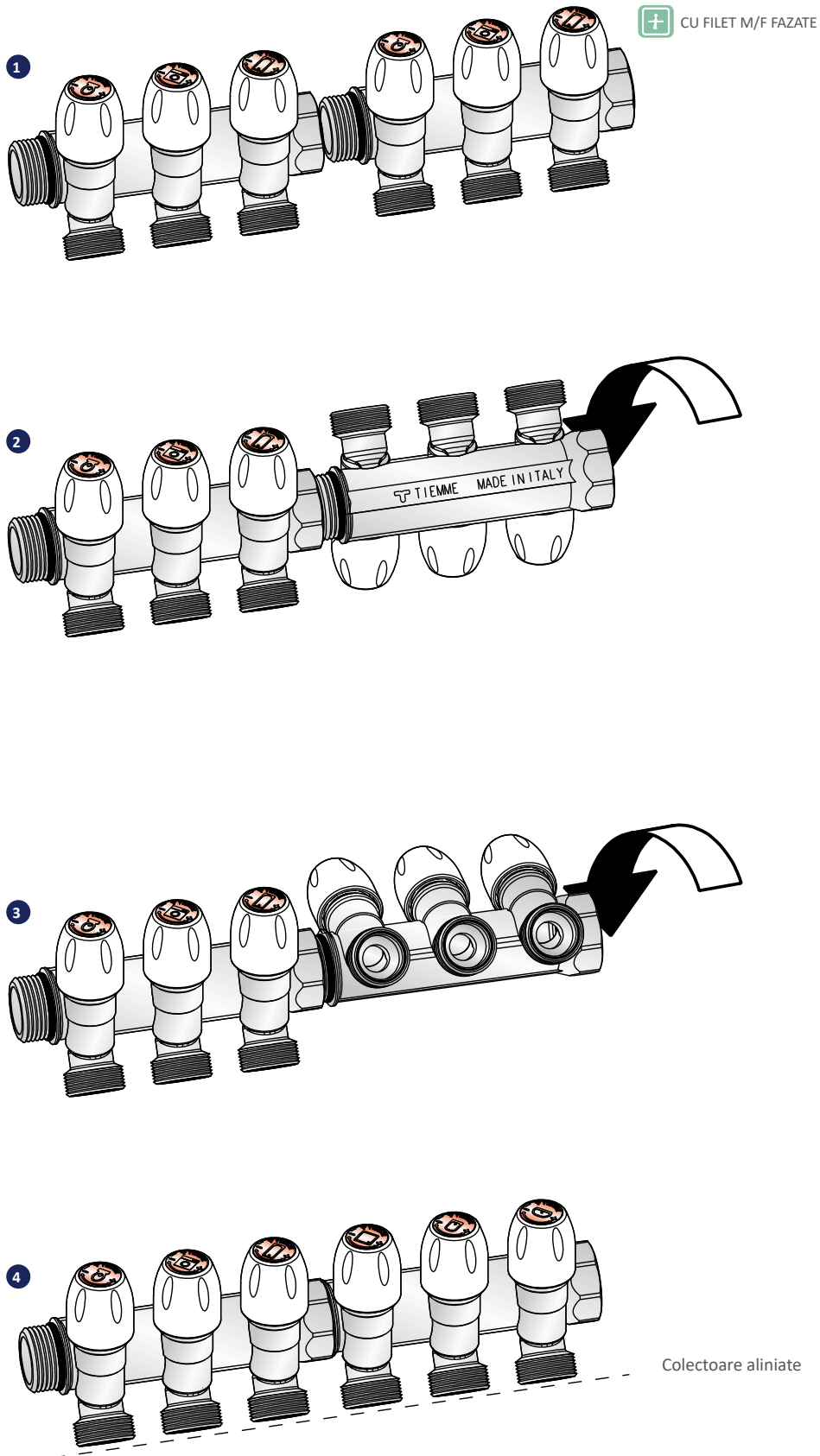



3023

Distribuitoare liniare compacte asamblate în cutii complete cu rozete cromate și capace cu robineti de închidere

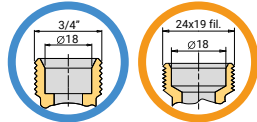

BREVETAT

3 cai apa rece si 3 cai apa calda pe aceeasi parte

Cod	Dimensiune	Pret €	Ambalare
304 0152	295 x 226 x 77		1/1



3023RAC

Cot dublu pentru caseta SANIBOX ART.3023

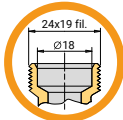

Cod	Dimensiune	Pret €	Ambalare
179 0337	1/2" - 24 x 19 fil (Ø18)		10/100

TUTORIAL VIDEO



Colectoare de distributie pre-asamblate in cutie "SANIBOX"

Vezi pagina cu tabelul de rotatii ale piulitei de la sfarsitul capitoului



3033

Colectoare lineare premontate cu rozete, capace cromate si robineti de inchidere in caseta PVC

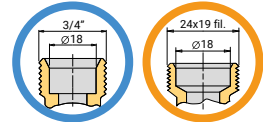

BREVETAT

6 cai apa rece si 4 cai apa calda pe aceeasi parte

N° 3 Trei capace furnizate in caseta

Cod	Dimensiune	Pret €	Ambalare
304 0007	295 x 226 x 77		1/1



3035

Colectoare lineare premontate cu rozete, capace cromate si robineti de inchidere in caseta PVC

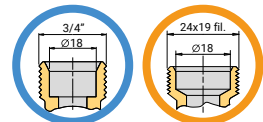

BREVETAT

6 cai apa rece si 4 cai apa calda pe parti opuse

N° 3 Trei capace furnizate in caseta

Cod	Dimensiune	Pret €	Ambalare
304 0008	295 x 226 x 77		1/1

3023-3033-3035

GHID DE CONEXIUNI

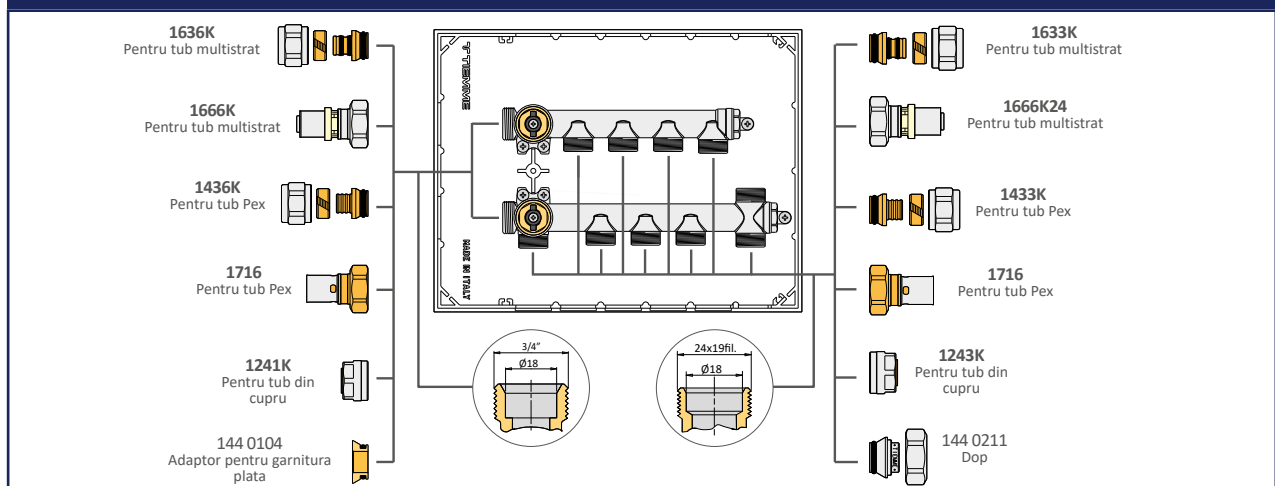

**3023**

3 CAI APA RECE SI 3 CAI APA CALDA PE ACEEASI PARTE

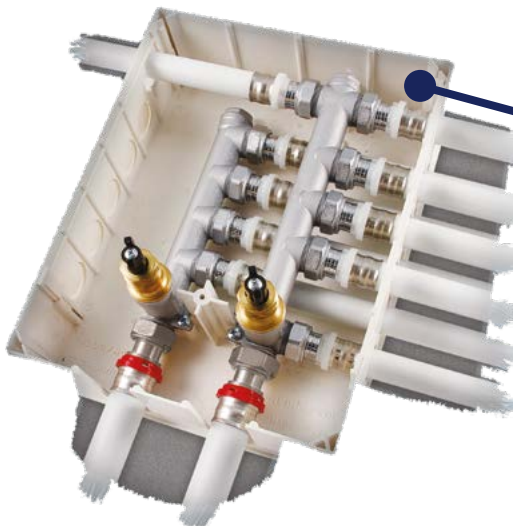
**3033**

6 CAI APA RECE SI 4 CAI APA CALDA PE ACEEASI PARTE

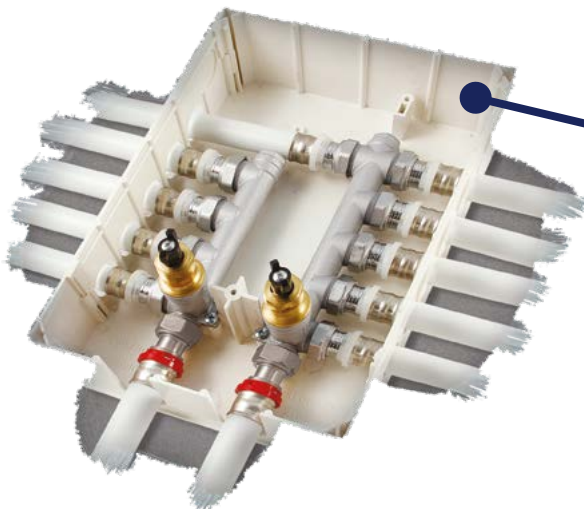
**3035**

6 CAI APA RECE SI 4 CAI APA CALDA PE LATURI OPUSE



LISTA DE PREȚURI

Utilizare cu caseta 1810, 1812, 1910P, 1920-1930 și 1939-1940 (pag. 212)

**1912
1922**

Colector "LINEARE" din alama CW617N. Interaxa 36 mm și iesiri 1/2"x16

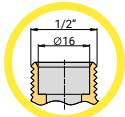

i Disponibila la cerere versiunea nichelata

Cod	Diametru	Cai	Dimens.	Pret €	Ambalare
191 0004	3/4"G	2	1/2"(Ø16)		1/50
191 0002	3/4"G	3	1/2"(Ø16)		1/40
191 0001	3/4"G	4	1/2"(Ø16)		1/30
191 0003	3/4"G	5	1/2"(Ø16)		1/25
191 0020	1"G	2	1/2"(Ø16)		1/40
191 0007	1"G	3	1/2"(Ø16)		1/30
191 0005	1"G	4	1/2"(Ø16)		1/25
191 0011	1"G	5	1/2"(Ø16)		1/20

**1912R**

Colector "LINEARE" din alama CW617N. Interaxa 36 mm și iesiri 1/2"x16. Filet fazat cu O-ring

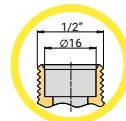

+ CU FILET M/F FAZATE

Cod	Diametru	Cai	Dimens.	Pret €	Ambalare
191 0192	3/4"G	2	1/2"(Ø16)		1/50
191 0193	3/4"G	3	1/2"(Ø16)		1/40
191 0194	3/4"G	4	1/2"(Ø16)		1/30
191 0195	3/4"G	5	1/2"(Ø16)		1/25

**1912-1912R
1922**

GHID DE CONEXIUNI

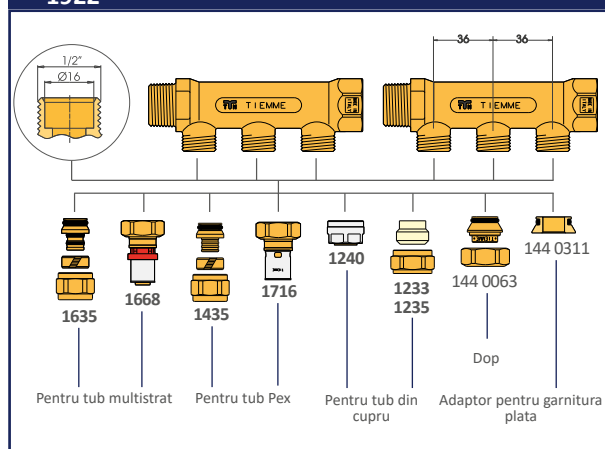

i Vezi pagina cu tabelul de rotatii ale piulței de la sfarsitul capitoului

Utilizare cu caseta 1810, 1812, 1910P, 1920-1930 și 1939-1940 (pag. 212)



1883
1884
1885

Colector "LINEARE" din alama CW617N. Interaxa 50 mm si iesiri 3/4"x18 (EUROCONO)

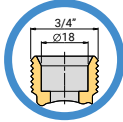

Cod	Diametru	Cai	Dimens.	Pret €	Ambalare
191 0024	3/4"G	2	3/4"(ø18)		1/40
191 0017	3/4"G	3	3/4"(ø18)		1/30
191 0022	3/4"G	4	3/4"(ø18)		1/20
191 0026	1"G	2	3/4"(ø18)		1/30
191 0008	1"G	3	3/4"(ø18)		1/25
191 0015	1"G	4	3/4"(ø18)		1/15
191 0028	1"1/4G	2	3/4"(ø18)		1/25
191 0016	1"1/4G	3	3/4"(ø18)		1/15
191 0014	1"1/4G	4	3/4"(ø18)		1/10



1885ISOL

Izolatie pentru colectoare cu interax 50 mm art.1885

Cod	Cai	Dimensiune	Pret €	Ambalare
557 0688	2	1"1/4		1/4
557 0689	3	1"1/4		1/2
557 0690	4	1"1/4		1/2

1883-1884
1885

GHID DE CONEXIUNI

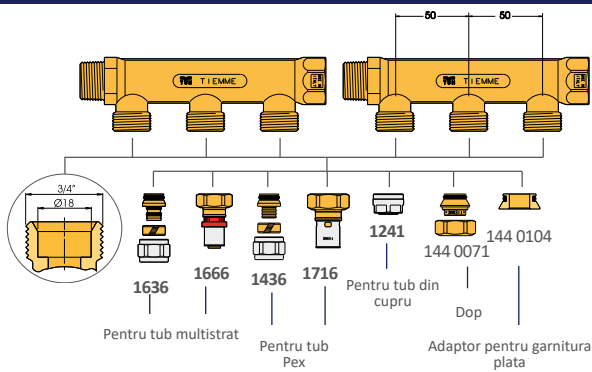

i Vezi pagina cu tabelul de rotatii ale piulitei de la sfarsitul capitolului



1895

Colector "LINEARE" din alama CW617N. Interaxa 36 mm si iesiri 24x19 fil (ø18). Filet fazat cu O-ring.

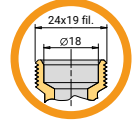

+ CU FILET M/F FAZATE

i Disponibil in versiune cromata

Cod	Diametru	Cai	Dimens.	Pret €	Ambalare
191 0079	3/4"G	2	24 x 19 fil (ø18)		1/50
191 0072	3/4"G	3	24 x 19 fil (ø18)		1/40
191 0070	3/4"G	4	24 x 19 fil (ø18)		1/30
191 0067	3/4"G	5	24 x 19 fil (ø18)		1/25
191 0084	1"G	2	24 x 19 fil (ø18)		1/40
191 0085	1"G	3	24 x 19 fil (ø18)		1/30
191 0086	1"G	4	24 x 19 fil (ø18)		1/25
191 0087	1"G	5	24 x 19 fil (ø18)		1/20

1895

GHID DE CONEXIUNI

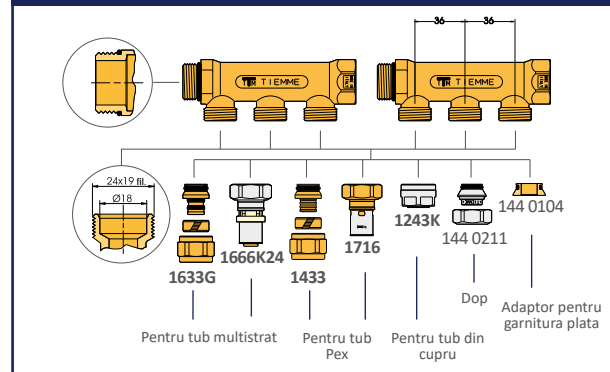

Utilizare cu caseta 1812, 1939-1940 (pag. 212)

**3046**

Colector de distributie "FLOOR" din alama CW617N cu robineti termostaticabili. Filet fazat cu O-ring.

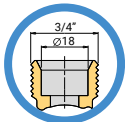

+ CU FILET M/F FAZATE

Cod	Diametru	Cai	Dimens.	Pret €	Ambalare
304 0015	1"G	2	3/4"(Ø18)		1/10
304 0011	1"G	3	3/4"(Ø18)		1/10
304 0010	1"G	4	3/4"(Ø18)		1/6
304 0133	1"1/4 G	2	3/4"(Ø18)		1/10
304 0134	1"1/4 G	3	3/4"(Ø18)		1/10
304 0135	1"1/4 G	4	3/4"(Ø18)		1/6

**3048**

Colector de distributie "FLOOR" din alama CW617N cu robineti cu memorie mecanica. Filet fazat cu O-ring.

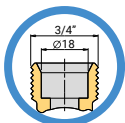

+ CU FILET M/F FAZATE

Cod	Diametru	Cai	Dimens.	Pret €	Ambalare
304 0016	1"G	2	3/4"(Ø18)		1/10
304 0014	1"G	3	3/4"(Ø18)		1/10
304 0013	1"G	4	3/4"(Ø18)		1/6
304 0139	1"1/4 G	2	3/4"(Ø18)		1/10
304 0140	1"1/4 G	3	3/4"(Ø18)		1/10
304 0141	1"1/4 G	4	3/4"(Ø18)		1/6

**3047**

Colector de distributie "FLOOR" din alama CW617N cu debitmetre pentru masurarea si reglarea fluxului. Filet fazat cu O-ring.

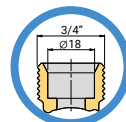

+ CU FILET M/F FAZATE

Cod	Diametru	Cai	Dimens.	Pret €	Ambalare
304 0017	1"G	2	3/4"(Ø18)		1/10
304 0012	1"G	3	3/4"(Ø18)		1/10
304 0009	1"G	4	3/4"(Ø18)		1/6
304 0136	1"1/4 G	2	3/4"(Ø18)		1/10
304 0137	1"1/4 G	3	3/4"(Ø18)		1/10
304 0138	1"1/4 G	4	3/4"(Ø18)		1/6

i Caseta 1812 si 1939 potrivita doar pentru colectoare de 1"

i Vezi pagina cu tabelul de rotatii ale piulitei de la sfarsitul capitolului

**3046-3047
3048**

GHID DE CONEXIUNI

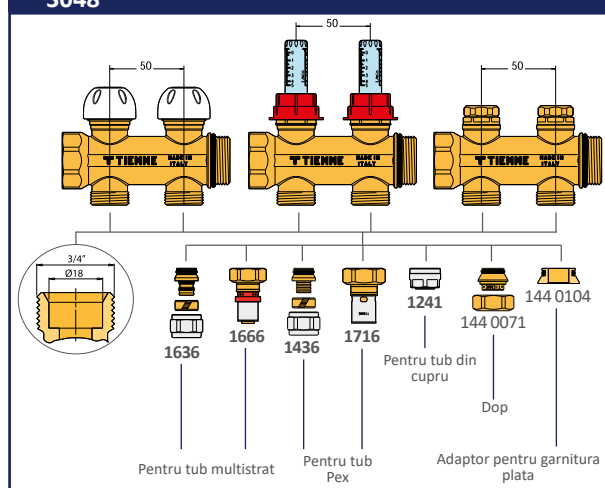

Utilizare cu caseta 1941 (pag. 213)



3053

Colector de distributie "INDUSTRIAL FLOOR" din alama CW617N cu robineti manuali de reglare si filet fazat cu o-ring

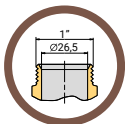

+ CU FILET M/F FAZATE

Cod	Diametru	Cai	Dimens.	Pret €	Ambalare
304 0027	1"1/2 G	2	1" G		1/10
304 0028	1"1/2 G	3	1" G		1/10



3054

Colector de distributie "INDUSTRIAL FLOOR" din alama CW617N cu filet fazat cu o-ring

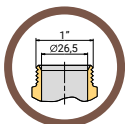

+ CU FILET M/F FAZATE

Cod	Diametru	Cai	Dimens.	Pret €	Ambalare
304 0029	1"1/2 G	2	1" G		1/10
304 0030	1"1/2 G	3	1" G		1/10



3055

Colector de distributie "INDUSTRIAL FLOOR" din alama CW617N cu robineti termostaticizabili. Filet fazat cu O-ring



+ CU FILET M/F FAZATE

Cod	Diametru	Cai	Dimens.	Pret €	Ambalare
304 0155	1"1/2 G	2	1" G		1/10
304 0156	1"1/2 G	3	1" G		1/10



1436N06

Pentru tub PEX
Adaptor pentru conexiuni 1"

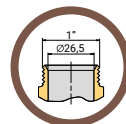

Cod	Dimensiune	Pret €	Ambalare
144 0232	20 x 2,0 - 1" G		10/200
144 0075	25 x 2,3 - 1" G		10/200



3874P

Capac de protectie

Cod	Dimensiune	Pret €	Ambalare
179 0037	-		5/50

3053-3054 3055

GHID DE CONEXIUNI

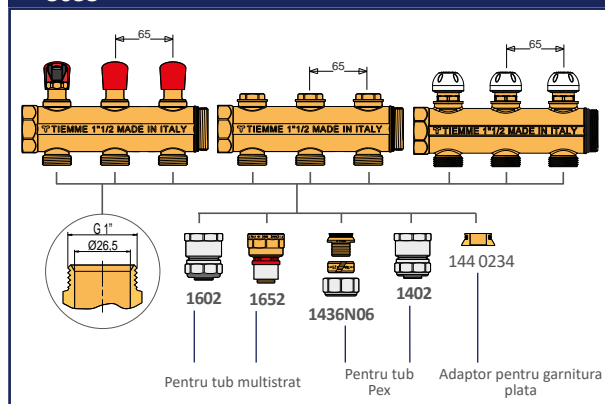

**9567KIT**

Adaptor "INDUSTRIAL FLOOR"
pentru servocomanda
electrotermica 9567

Accesoriu pentru art.3054

Piesa de schimb pentru art.3055

Cod	Dimensiune	Pret €	Ambalare
179 0328	-		1/100

9567-9567KIT

INSTRUCTIUNI DE MONTAJ

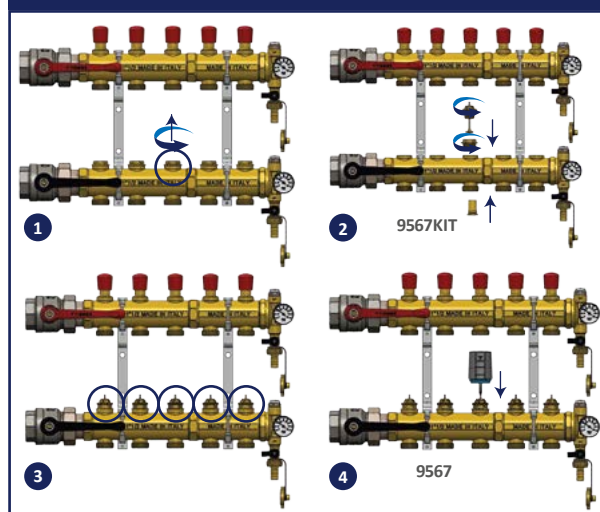

ACESORII PENTRU COLECTOARE

Robineti cu sfera trecere totala

**2121R**

Robinet drept cu olandez si
O-RING, cu pre-etansare

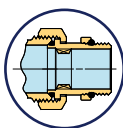

Cod	Dimensiune	Pret €	Ambalare
	maneta tip fluture rosie		
212 0017	3/4"		10/40
212 0013	1"		9/36
212 0027	1"1/4		6/24
	maneta tip fluture albastra		
212 0020	3/4"		10/40
212 0014	1"		9/36
212 0028	1"1/4		6/24

**2182R**

Robinet M/F de colt ISO 228
cu maneta tip fluture pentru
colectoare, cu etansare si
prindere pe O-RING,
cu pre-etansare

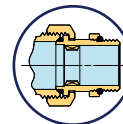



Cod	Dimensiune	Pret €	Ambalare
	maneta tip fluture rosie		
212 0050	3/4"		10/40
212 0048	1"		5/20
	maneta tip fluture albastra		
212 0049	3/4"		10/40
212 0044	1"		5/20

Robineti cu sfera trecere totala

**2180CPR**

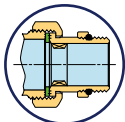
Robinet de colt cu olandez si garnitura O-RING.
GARNITURA PLATA, cu pre-etansare





Cod	Dimensiune	Pret €	Ambalare
 maneta tip fluture rosie			
212 0056	3/4"		10/40
212 0057	1"		5/20
 maneta tip fluture albastra			
212 0054	3/4"		10/40
212 0045	1"		5/20

**2181CPR**

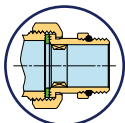
Robinet de colt cu olandez si garnitura O-RING pentru tub multistrat, cu pre-etansare.
GARNITURA PLATA





Cod	Dimensiune	Pret €	Ambalare
 maneta tip fluture rosie			
162 0045	20 x 3/4"		10/40
162 0014	26 x 3/4"		10/40
162 0010	26 x 1"		5/20
162 0015	32 x 1"		5/20
 maneta tip fluture albastra			
162 0046	20 x 3/4"		10/40
162 0004	26 x 3/4"		10/40
162 0009	26 x 1"		5/20
162 0013	32 x 1"		5/20

La cerere

**2120R**

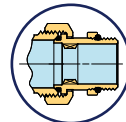
Robinet drept cu olandez, garnitura o-ring si termometru cu prindere reversibila, cu pre-etansare



 BREVETAT

Cod	Dimensiune	Pret €	Ambalare
 maneta tip fluture rosie			
212 0043	1"		5/20
 maneta tip fluture albastra			
212 0042	1"		5/20

**2183R**

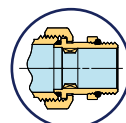
Robinet M/F de colt ISO 228 cu maneta tip fluture, cu pre-etansare, garnitura O-RING si termometru cu prindere reversibila

 BREVETAT

Cod	Dimensiune	Pret €	Ambalare
 maneta tip fluture rosie			
212 0031	1"		5/20
 maneta tip fluture albastra			
212 0032	1"		5/20

 Pentru gama completă de supape cu bilă, vezi capitolul 1 A

LISTA DE PREȚURI

Robineti cu sfera trecere totala

**2121RSAC**

Robinet drept cu olandez si O-RING, cu pre-etansare

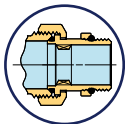

i Nr 1 cu maneta tip fluture de culoare albastra + Nr 1 cu maneta tip fluture de culoare rosie

Cod	Dimensiune	Pret €	Ambalare
386 0035	1"G		1/10

**2182RSAC**

Robinet M/F de colt ISO 228 cu maneta tip fluture pentru colectoare, cu etansare si prindere pe O-RING, cu pre-etansare

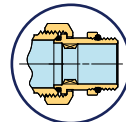

i Nr 1 cu maneta tip fluture de culoare albastra + Nr 1 cu maneta tip fluture de culoare rosie

Cod	Dimensiune	Pret €	Ambalare
386 0032	1"G		1/10

**2182**

Robinet M/F de colt ISO 228 cu maneta tip fluture pentru colectoare si etansare pe O-RING

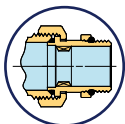

Cod	Dimensiune	Pret €	Ambalare
-----	------------	--------	----------

**maneta tip fluture rosie**

212 0046	1/2"		15/60
212 0038	3/4"		10/40
212 0040	1"		5/20

**maneta tip fluture albastra**

212 0047	1/2"		15/60
212 0039	3/4"		10/40
212 0041	1"		5/20

Robineti cu bilă compacte

**2114CPRKIT**

Set robineti sfera cu olandez garnitura plata model drept compact, cu maneta tip fluture culoare rosie si albastra si termometre ce au conexiune reversibila

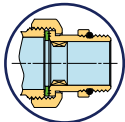
 BREVETAT

Cod	Dimensiune	Pret €	Ambalare
212 0195	1"		1/10

**2184CPRKIT**

Set robineti sfera cu olandez garnitura plata model coltar compact, cu maneta tip fluture culoare rosie si albastra si termometre ce au conexiune reversibila

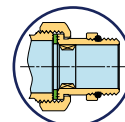
 BREVETAT

Cod	Dimensiune	Pret €	Ambalare
212 0197	1"		1/10

**2116CPRKIT**

Set robineti sfera cu olandez garnitura plata model drept compact, cu maneta tip fluture culoare rosie si albastra fara termometre

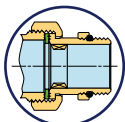
 BREVETAT

Cod	Dimensiune	Pret €	Ambalare
212 0196	1"		1/10

**2186CPRKIT**

Set robineti sfera cu olandez garnitura plata model coltar compact, cu maneta tip fluture culoare rosie si albastra fara termometre

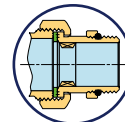
 BREVETAT

Cod	Dimensiune	Pret €	Ambalare
212 0198	1"		1/10



**9567**

Servocomanda electrotermica pentru robinet termostaticabil de inchidere cu indicator de cursa.

NORMAL INCHIS

Cod	Dimensiune	Pret €	Ambalare
450 0026	24V		1/20
450 0012	230V		1/20
450 0045	24V		1/20
450 0006	230V		1/20

Versiuni cu microinterruptor auxiliar

**2990G**

Robinet cu sfera pentru golire



Cod	Dimensiune	Pret €	Ambalare
295 0024	3/8"		25/100
295 0001	1/2"		25/100
295 0040	1/2"		10/50

Versiune cu lant metalic

**H8996**

Stut pentru termometru

Cod	Dimensiune	Pret €	Ambalare
040 0088	3/8"		1/100

**2070**

Termometru \varnothing 40 L=30 mm
scara 0 ÷ 80°C

Cod	Dimensiune	Pret €	Ambalare
179 0006	-		10/50

**H9709**

Indicatoare de debit pentru Colector de distributie FLOOR

Cod	Dimensiune	Pret €	Ambalare
040 0196	-		5/100

**H9708**

Ventil termostaticabil pentru colector de distributie FLOOR

Cod	Dimensiune	Pret €	Ambalare
040 0241	-		10/50

**1886**

Racord drept M/F

Disponibila la cerere versiunea nichelata

Cod	Dimensiune	Pret €	Ambalare
195 0021	1/2" x 3/4"		10/200

**1887**

Racord drept M/M cu garnitura O-ring pentru colectoare

Disponibila la cerere versiunea nichelata

Cod	Dimensiune	Pret €	Ambalare
195 0018	3/4" - 1/2" x 16		10/250

**1890**

Racord terminal pentru colectoare cu iesiri de 3/8" si 1/2"

i Disponibila la cerere versiunea nichelata

Cod	Dimensiune	Pret €	Ambalare
195 0009	3/4"		10/130
195 0001	1"		5/90
195 0006	1"1/4		5/60

**1889R**

Racord terminal F cu filet fazat

Cod	Dimensiune	Pret €	Ambalare
195 0044	3/4" x 1/2" x 1/2"		10/100
195 0039	1" x 1/2" x 1/2"		10/100
Versiunea cromata			
195 0031	3/4" x 1/2" x 1/2"		10/100
195 0010	1" x 1/2" x 1/2"		10/100

**1890R**

Racord terminal M cu filet fazat si O-ring

Cod	Dimensiune	Pret €	Ambalare
195 0054	3/4" x 1/2" x 1/2"		10/100
195 0040	1" x 1/2" x 1/2"		10/100
Versiunea cromata			
195 0051	3/4" x 1/2" x 1/2"		10/100
195 0026	1" x 1/2" x 1/2"		10/100

**1880**

Dop F pentru colectoare

i Disponibila la cerere versiunea nichelata si cromata

Cod	Dimensiune	Pret €	Ambalare
150 0342	3/8"		25/200
150 0058	1/2"		25/200
150 0041	3/4"		10/100
150 0108	1"		10/100
150 0285	1"1/4		5/100
150 0327	1"1/2		5/60
150 0751	2"		2/50

**1878**

Dop M pentru colectoare

i Disponibila la cerere versiunea nichelata

Cod	Dimensiune	Pret €	Ambalare
150 0273	3/8"		25/200
150 0040	1/2"		25/300
150 0019	3/4"		10/150
150 0077	1"		10/100
150 0222	1"1/4		5/100
150 0865	1"1/2		5/50
150 0866	2"		2/40

**1881**

Reductie M/F cu garnitura O-ring pentru colectoare

i Disponibila la cerere versiunea nichelata

Cod	Dimensiune	Pret €	Ambalare
195 0013	3/4" x 3/8"		10/300
195 0019	3/4" x 1/2"		10/300
195 0020	1" x 3/8"		10/200
195 0005	1" x 1/2"		10/200
195 0008	1" x 3/4"		10/200
195 0034	1"1/4 x 3/8"		10/150
195 0017	1"1/4 x 1/2"		10/150
195 0066	1"1/2 x 3/4"		5/70



**1882**

Dop M cu garnitura O-ring
pentru colectoare

 Disponibila la cerere versiunea nichelata si cromata

Cod	Dimensiune	Pret €	Ambalare
195 0016	1/2"		10/500
195 0004	3/4"		10/400
195 0002	1"		10/200
195 0007	1"1/4		10/150
195 0041	1"1/2		5/70
195 0052	2"		2/40

**3339**

Racord de legatura 3 piese M/M
cu O-ring

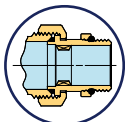

Cod	Dimensiune	Pret €	Ambalare
195 0036	3/4"		1/40
195 0027	1"		1/35
195 0043	1"1/4		1/30

**3341**

Racord drept M/M cu O-ring si
inel de strangere

Cod	Dimensiune	Pret €	Ambalare
195 0046	3/4"		1/100
195 0029	1"		1/35
195 0035	1"1/4		1/30

**1513**

Excentric cu ampatament 15
mm M/F

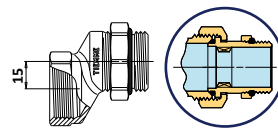

Cod	Dimensiune	Pret €	Ambalare
150 0444	1"		2/50

**1514**

Excentric cu ampatament 25
mm M/F

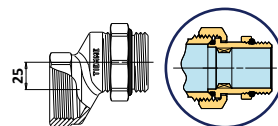

Cod	Dimensiune	Pret €	Ambalare
150 0672	1"		2/40

**1872**

Maneta "NINO"

Cod	Dimensiune	Pret €	Ambalare
179 0005	albastru		50/500
179 0007	rosie		50/500

**1892**

Cheie pentru racorduri

Cod	Dimensiune	Pret €	Ambalare
164 0029	Ch 23-27		5/40
1640053	Ch 24-27		5/40
164 0016	Ch 24-30		5/40

■ pentru 1240-1241-1243

■ pentru seria 1600 si 1241-1243-1433-1435-1635

■ pentru seria 1600 si 1435-1436-1635-1636

**1896**

Supapa automata de aerisire nichelata

Cod	Dimensiune	Pret €	Ambalare
198 0068	1/2"		1/20
198 0074	3/4"		1/20

Filet masculin cu O-ring

**1896GG**

Ansamblu Flotor pentru supapele de aerisire automate 1896

Cod	Dimensiune	Pret €	Ambalare
198 0070	-		1/20

**1914**

Supapa automata de aerisire cu racord lateral cu corp de 39 mm nichelata

Cod	Dimensiune	Ø	Pret €	Ambalare
198 0126	3/8"	39		1/50
198 0127	1/2"	39		1/50

**1913**

Supapa automata de aerisire nichelata

Cod	Dimensiune	Ø	Pret €	Ambalare
198 0128	3/8"	39		1/50
198 0129	1/2"	39		1/50

**1913G**

Supapa automata de aerisire

Cod	Dimensiune	Ø	Pret €	Ambalare
198 0130	3/8"	39		1/50
198 0131	1/2"	39		1/50

**1898**

Supapa automata de aerisire laterala

Cod	Dimensiune	Ø	Pret €	Ambalare
198 0005	3/8"	39		1/50
198 0004	1/2"	39		1/50

**1898G34**

Supapa automata de aerisire laterala cu corp de 34 mm

Cod	Dimensiune	Ø	Pret €	Ambalare
198 0114	3/8"	34		1/70
198 0092	1/2"	34		1/70

**1898KIT34**

Set Supapa automata de aerisire + Supapa de blocare

 Kit format din 1898G34+1901P

Cod	Dimensiune	Ø	Pret €	Ambalare
198 0112	3/8"	34		1/70
198 0113	1/2"	34		1/70

**1899**

Supapa automata de aerisire cu racord lateral

Cod	Dimensiune	Ø	Pret €	Ambalare
198 0011	3/8"	39		1/50
198 0003	1/2"	39		1/50

Până la terminarea stocului

**1900**

Supapa automata de aerisire

Cod	Dimensiune	Ø	Pret €	Ambalare
198 0002	3/8"	39		1/50
198 0001	1/2"	39		1/50
198 0013	3/4"	45,5		1/25
198 0022	1"	45,5		1/25

Până la terminarea stocului

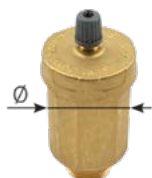
**1900G**

Supapa automata de aerisire

Cod	Dimensiune	Ø	Pret €	Ambalare
198 0014	3/8"	39		1/50
198 0007	1/2"	39		1/50

Până la terminarea stocului

**1900N34**

Supapa automata de aerisire

Cod	Dimensiune	Ø	Pret €	Ambalare
198 0024	3/8"	34		1/40
198 0029	1/2"	34		1/40

**1900G34**

Supapa automata de aerisire

Cod	Dimensiune	Ø	Pret €	Ambalare
198 0017	3/8"	34		1/40
198 0019	1/2"	34		1/40

**1901**

Supapa de blocare cu garnitura de etansare si obturator din alama

Cod	Dimensiune	Pret €	Ambalare
198 0012	3/8"		10/300
198 0009	1/2"		10/100
198 0023	M 1/2" - F 3/8"		10/300

**1901P**

Supapa de blocare cu garnitura de etansare si obturator din plastic

Cod	Dimensiune	Pret €	Ambalare
198 0106	3/8"		10/300
198 0108	1/2"		10/300
198 0110	M 1/2" - F 3/8"		10/300

**1901PN**

Supapa de blocare nichelata cu garnitura de etansare si obturator din plastic

Cod	Dimensiune	Pret €	Ambalare
198 0107	3/8"		10/300
198 0109	1/2"		10/300
198 0111	M 1/2" - F 3/8"		10/300

La cerere

**1812**

Caseta universala cu seturi de fixare pentru colectoare "NINO", "LINEARE", "MAXIMA", "MAXIMA CORNER", "RUBINO" si "MAXIMA VERTI"

i Pentru colectoare bara se va folosi setul de prindere 1805

Cod	Dimensiune	Pret €	Ambalare
181 0129	310 x 295 x 80		1/5
181 0130	420 x 295 x 80		1/5
181 0131	510 x 295 x 80		1/5
181 0181	620 x 295 x 80		1/5

**1810**

Caseta universala

i Set de prindere vezi 1807-1808

Cod	Dimensiune	Pret €	Ambalare
181 0014	300 x 250 x 80		1/10
181 0008	400 x 250 x 80		1/10

**1910P**

Caseta universala pentru colectoare "NINO" si "LINEARE"

Cod	Dimensiune	Pret €	Ambalare
181 0017	400 x 240 x 80		1/19
181 0018	500 x 240 x 80		1/14
181 0021	600 x 240 x 80		1/12

**1920****1930**

Caseta universala din metal

i Set de prindere vezi 1807-1808

Cod	Dimensiune	Pret €	Ambalare
181 0028	400 x 280 x 90		1/1
181 0026	500 x 280 x 90		1/1
181 0031	600 x 280 x 90		1/1
181 0027	500 x 450 x 90		1/1
181 0029	600 x 450 x 90		1/1
181 0037	700 x 450 x 90		1/1
181 0036	800 x 450 x 90		1/1

**1931**

Caseta din metal prevazuta cu set de prindere pentru kit de amestec

i Adancime reglabila de la 120 mm la 170 mm

Cod	Dimensiune	Pret €	Ambalare
181 0132	600 x 670 x 120 ÷ 170		1/1

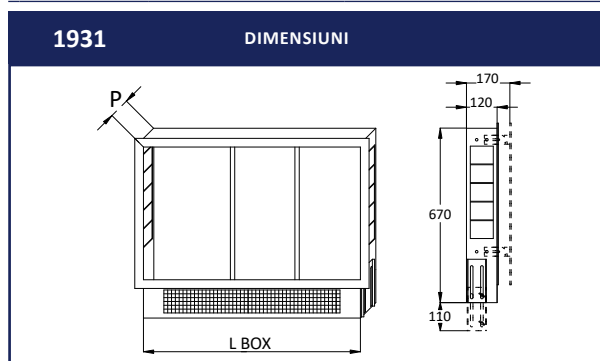

**1939**

Caseta reglabila pe inaltime si in adancime pentru colectoare tip bara si "FLOOR". Necesita seturi de prindere art. 1865-1864 in functie de diametrul colectorului

i Adancime reglabila de la 90 mm la 140 mm

Cod	Dimensiune	Pret €	Ambalare
181 0192	400 x 660 x 90 ÷ 140		1/1
181 0193	500 x 660 x 90 ÷ 140		1/1
181 0206	600 x 660 x 90 ÷ 140		1/1
181 0194	700 x 660 x 90 ÷ 140		1/1
181 0195	1000 x 660 x 90 ÷ 140		1/1

1939

DIMENSIUNI

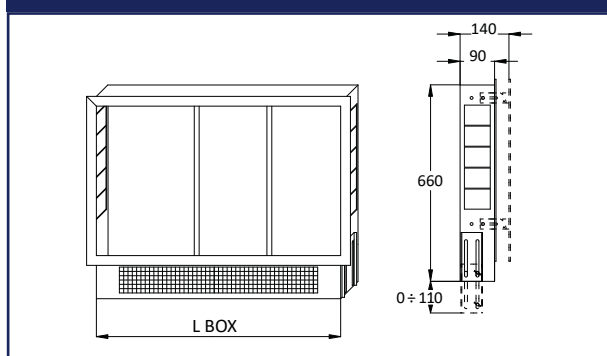
**1940**

Caseta reglabila pe inaltime si in adancime pentru grupuri de amestec si distributie si colectoare.

Necesita seturi de prindere

i Adancime reglabila de la 120 mm la 170 mm

Cod	Dimensiune	Pret €	Ambalare
181 0020	600 x 670 x 120 ÷ 170		1/1
181 0016	700 x 670 x 120 ÷ 170		1/1
181 0015	850 x 670 x 120 ÷ 170		1/1
181 0019	1000 x 670 x 120 ÷ 170		1/1
181 0025	1200 x 670 x 120 ÷ 170		1/1

1940

DIMENSIUNI

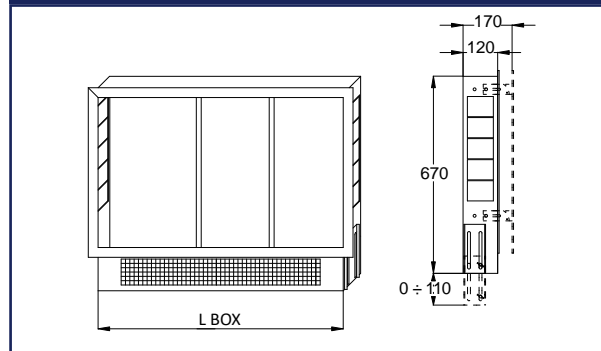
**1941**

Caseta externa pentru colectoare "INDUSTRIAL FLOOR"

Cod	Dimensiune	Pret €	Ambalare
181 0110	900 x 650 x 170		1/1
181 0111	1200 x 650 x 170		1/1

1941

DIMENSIUNI

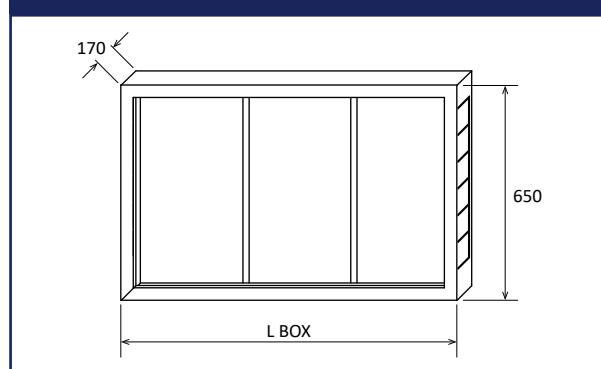

**1807**

Seturi de prindere pentru colectoare "RUBINO", "NINO", "MAXIMA CORNER", "MAXIMA VERTI", "LINEARE" si "MAXIMA" pentru casele art. 1810-1920-1930

Cod	Dimensiune	Pret €	Ambalare
181 0022	3/4" - 1"		1/10

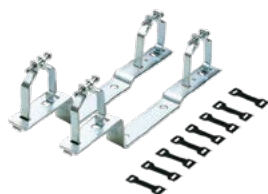
**1865**

Seturi de prindere pentru colectoare bara de 3/4" - 1" - 1"1/4 pentru caseta art. 1940 si "INDUSTRIAL FLOOR" pentru caseta art. 1941

Cod	Dimensiune	Pret €	Ambalare
181 0007	3/4" - 1" - 1"1/4 - 1"1/2		1/25

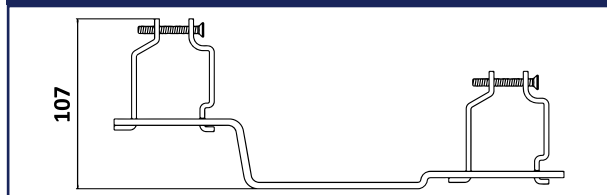
1865 DIMENSIUNI**1870**

Kit fixare colectoare "MAXIMA", "MAXIMA CORNER", "NINO", "RUBINO" si "MAXIMA VERTI"

Cod	Dimensiune	Pret €	Ambalare
181 0109	3/4"		1/25
181 0108	1"		1/25

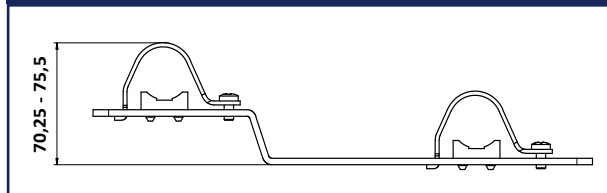
1870 DIMENSIUNI**1877SKIT**

Kit de fixare a colectoarelor "MAXIMA", "MAXIMA CORNER", "MAXIMA VERTI", "NINO" si "RUBINO"

Cod	Dimensiune	Pret €	Ambalare
181 0100	3/4"		1/5
181 0101	1"		1/5

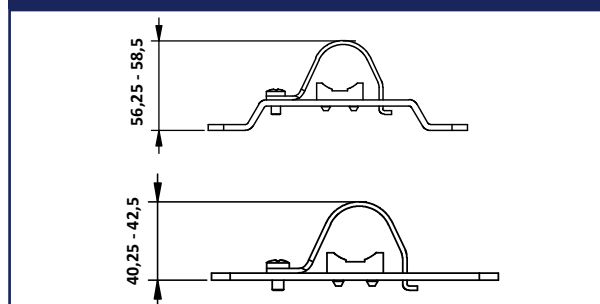
1877SKIT DIMENSIUNI**3049SKIT**

Kit de fixare a colectoarelor "FLOOR"

Cod	Dimensiune	Pret €	Ambalare
385 0063	1"		1/5

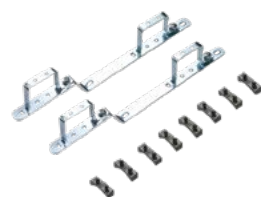
**1863**

Set de prindere pentru colectoare "FLOOR" pentru caseta Art. 1931-1939-1940

Cod	Dimensiune	Pret €	Ambalare
181 0032	1"		1/25
181 0203	1"1/4		1/25

Compatibil si cu colectoare LINEARE

NOU TATI

**1812VIT**

Pereche de suruburi pentru caseta universala art. 1812

Cod	Dimensiune	Pret €	Ambalare
181 0155	-		10/200



**2139**

Robinet cu sfera motorizat, cu trecere totala, cu 2 cai F/F, pentru actuator cu baza ISO5211

Cod	Dimensiune	Pret €	Ambalare
213 0104	1/2"		15/60
213 0107	3/4"		10/40
213 0108	1"		7/28

**2138**

Robinet cu sfera, motorizat cu 2 iesiri M/F

Disponibil si cu alimentare 24 Vac

Cod	Dimensiune	Aliment.	Pret €	Ambalare
213 0020	1/2"	230 Vac		1/14
213 0003	3/4"	230 Vac		1/14
213 0007	1"	230 Vac		1/14
213 0019	1"1/4	230 Vac		1/14

**2133**

Robinet cu sfera, motorizat cu 2 iesiri M/M

Disponibil si cu alimentare 24 Vac

Cod	Dimensiune	Aliment.	Pret €	Ambalare
213 0011	3/4"	230 Vac		1/14
213 0016	1"	230 Vac		1/14

**9535**

Servomotor pentru robinet cu 2 cai (art. 2138-2133); rotatie monodirectionala cu unghi de 90° dotat cu siguranta de protectie. Carcasa cu grad de protectie IP44

Cod	Tensiune	Timp manevra	Pret €	Ambalare
213 0024	230 Vac	30 sec		1/8
213 0072	24 Vac	30 sec		1/8

**2134**

Robinet cu sfera, motorizat cu 3 cai deviator, cu 3 intrari

Disponibil si cu alimentare 24 Vac

Cod	Dimensiune	Aliment.	Pret €	Ambalare
213 0009	3/4"	230 Vac		1/4
213 0018	1"	230 Vac		1/4

**9537**

Servomotor pentru robinet deviator (art.2134); rotatie monodirectionala cu unghi de 180° dotat cu siguranta de protectie. Carcasa cu grad de protectie IP44

Cod	Tensiune	Timp manevra	Pret €	Ambalare
213 0025	230 Vac	60 sec		1/8
213 0031	24 Vac	60 sec		1/8

**2137**

Robinet cu sfera, motorizat cu 3 cai cu by-pass, cu 3 intrari

Disponibil si cu alimentare 24 Vac

Cod	Dimensiune	Aliment.	Pret €	Ambalare
213 0021	3/4"	230 Vac		1/4
213 0015	1"	230 Vac		1/4

**2136**

Robinet cu sfera, motorizat cu 3 cai cu by-pass, cu 4 intrari, distanta variabila intre axe (50-63 mm pentru robinet de 3/4" - 55-63 mm pentru robinet de 1")

Disponibil si cu alimentare 24 Vac

Cod	Dimensiune	Aliment.	Pret €	Ambalare
213 0013	3/4"	230 Vac		1/4
213 0028	1"	230 Vac		1/4

**9536**

Servomotor pentru robinet de zona cu by-pass (art. 2136-2137); rotatie bidirectionala cu unghi de 90° dotat cu siguranta de protectie. Carcasa cu grad de protectie IP44

Cod	Tensiune	Timp manevra	Pret €	Ambalare
213 0030	230 Vac	30 sec		1/8
213 0037	24 Vac	30 sec		1/8

2138 - 2133

CARACTERISTICI TEHNICE

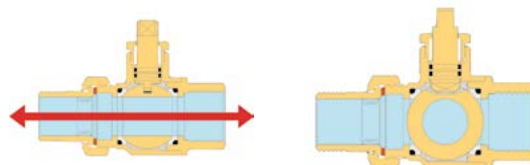

- Alimentare 230 Vac sau 24 Vac
- Contact releu 6A 250 Vac
- Grad de protectie IP 44
- Cuplu maxim de rotatie 10 Nm
- Timp rotatie 30 sec.
- Siguranta 5x20 F350 mA

2134

CARACTERISTICI TEHNICE

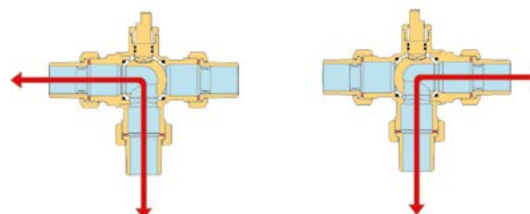

- Alimentare 230 Vac sau 24 Vac
- Contact releu 6A 250 Vac
- Grad de protectie IP 44
- Cuplu maxim de rotatie 10 Nm
- Timp rotatie 60 sec.
- Siguranta 5x20 F350 mA.

2137

CARACTERISTICI TEHNICE

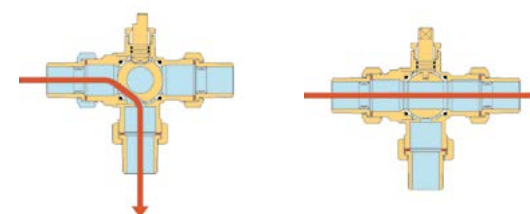

- Alimentare 230 Vac sau 24 Vac
- Contact releu 6A 250 Vac
- Grad de protectie IP 44
- Cuplu maxim de rotatie 10 Nm
- Timp rotatie 30 sec.
- Siguranta 5x20 F350 mA

2136

CARACTERISTICI TEHNICE

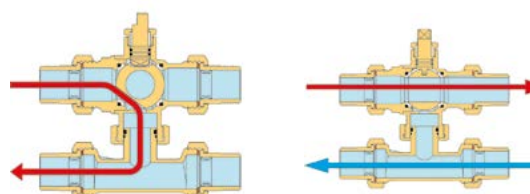

- Alimentare 230 Vac sau 24 Vac
- Contact releu 6A 250 Vac
- Grad de protectie IP 44
- Cuplu maxim de rotatie 10 Nm
- Timp rotatie 30 sec.
- Siguranta 5x20 F350 mA



EXEMPLU DE INSTALARE

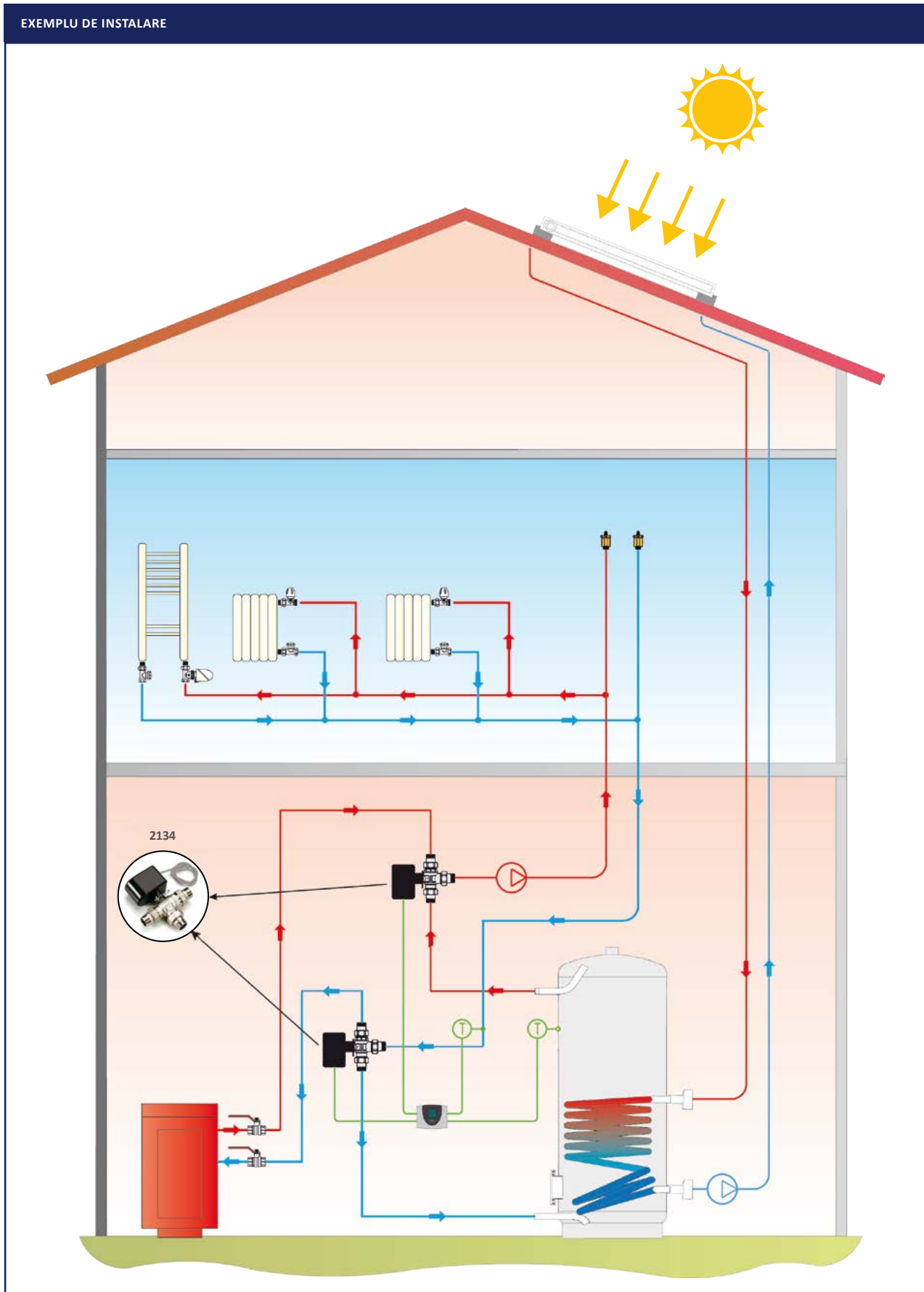

11 ROBINETI CU SFERA, MOTORIZATI

EXEMPLU DE INSTALARE

Imaginea de mai jos reprezinta o instalatie echipata cu robineti motorizati cu 3 cai si by-pass. Robinetii motorizati cu 3 cai au rolul de a intrerupe admisia cu agent termic catre incaperile unde temperatura setata a fost atinsa, by-pass-ul deviator asigurand totodata un debit constant pentru pompa de circulatie.

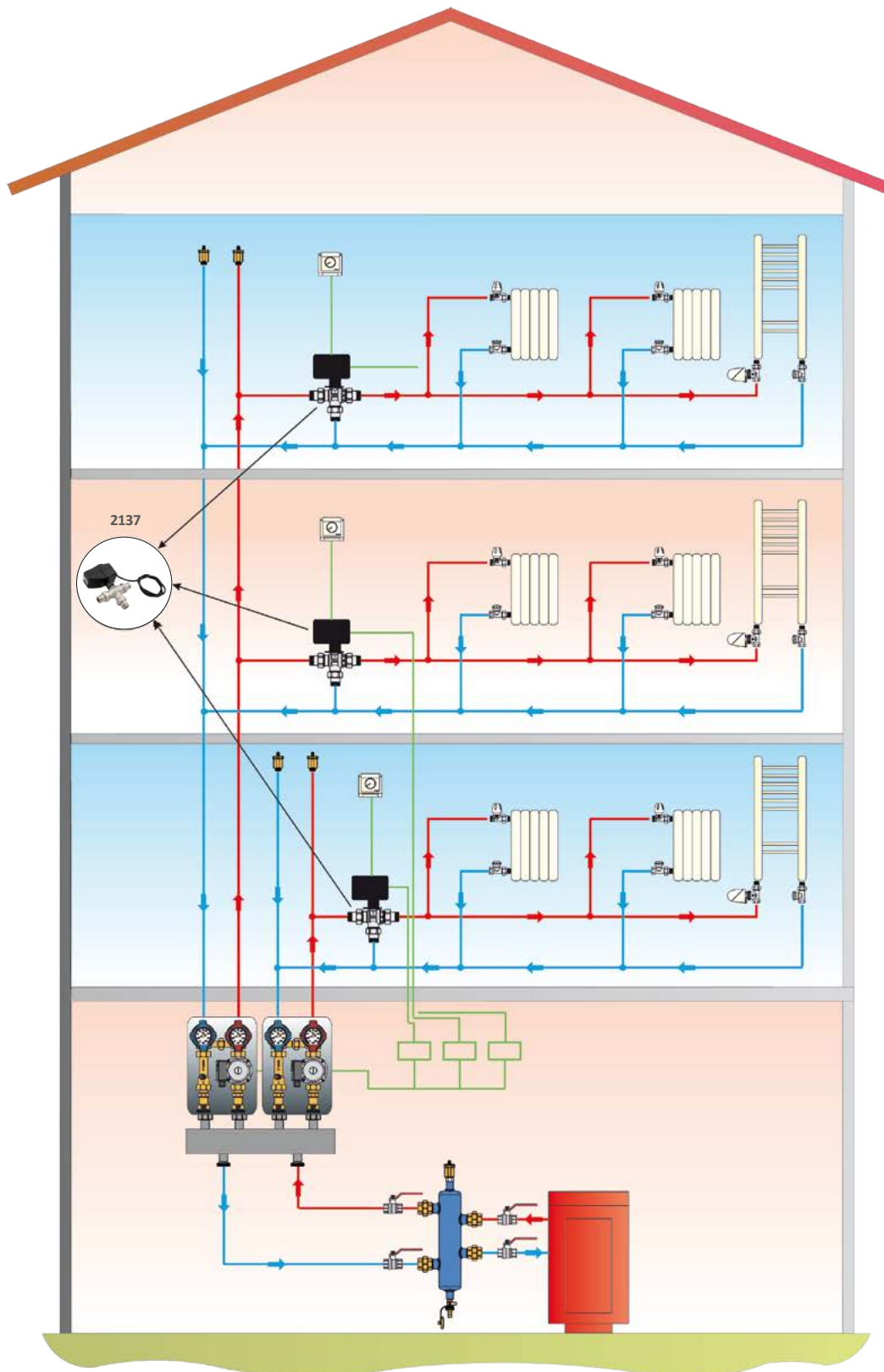

Adaptor pentru conexiuni 1/2" (ø16)

**1233**

Pentru tub din CUPRU

Piulita si inel in P.T.F.E. pentru conexiuni 1/2"x16

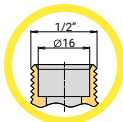

Cod	Dimensiune	Pret €	Ambalare
120 0113	16/10 - 1/2" (ø16)		50/500
120 0007	16/12 - 1/2" (ø16)		50/400
120 0042	16/14 - 1/2" (ø16)		50/500
120 0274	16/15 - 1/2" (ø16)		50/500

**1233N**

Pentru tub din CUPRU

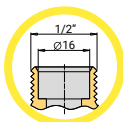
Piulita si inel in P.T.F.E. pentru conexiuni 1/2"x16
Versiunea nichelata

Cod	Dimensiune	Pret €	Ambalare
120 0130	16/10 - 1/2" (ø16)		50/500
120 0068	16/12 - 1/2" (ø16)		50/400
120 0108	16/14 - 1/2" (ø16)		50/500
120 0273	16/15 - 1/2" (ø16)		50/500

**1235**

Pentru tub din CUPRU

Piulita si inel in P.T.F.E. pentru conexiuni 1/2"x16

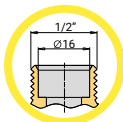

Cod	Dimensiune	Pret €	Ambalare
120 0093	16 - 1/2" (ø16)		50/600

**1235N**

Pentru tub din CUPRU

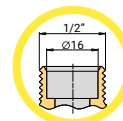
Piulita si inel in P.T.F.E. pentru conexiuni 1/2"x16
Versiunea nichelata

Cod	Dimensiune	Pret €	Ambalare
120 0105	16 - 1/2" (ø16)		50/600

**1240N**

Pentru tub din CUPRU

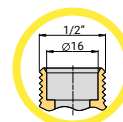
Piulita si inel de compresie pentru conexiuni 1/2"x16
Versiunea nichelata

Cod	Dimensiune	Pret €	Ambalare
144 0028	10 - 1/2" (ø16)		10/400
144 0005	12 - 1/2" (ø16)		10/400
144 0013	14 - 1/2" (ø16)		10/400
144 0016	15 - 1/2" (ø16)		10/400
144 0025	16 - 1/2" (ø16)		10/400

**1240K**

Pentru tub din CUPRU

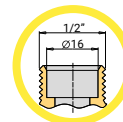
Piulita si inel de compresie pentru conexiuni 1/2"x16
Versiunea cromata

Cod	Dimensiune	Pret €	Ambalare
144 0126	10 - 1/2" (ø16)		10/400
144 0116	12 - 1/2" (ø16)		10/400
144 0127	14 - 1/2" (ø16)		10/400
144 0112	15 - 1/2" (ø16)		10/400
144 0128	16 - 1/2" (ø16)		10/400

Adaptor pentru conexiuni 1/2" (Ø16)

**1435**

Pentru tub PEX

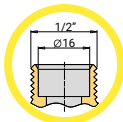
Adaptor pentru conexiuni
1/2"x16

Cod	Dimensiune	Pret €	Ambalare
144 0039	12 x 1,1 - 1/2" (Ø16)		10/350
144 0029	12 x 2,0 - 1/2" (Ø16)		10/350
144 0102	14 x 2,0 - 1/2" (Ø16)		10/350
144 0026	15 x 2,5 - 1/2" (Ø16)		10/350
144 0049	16 x 1,5 - 1/2" (Ø16)		10/350
144 0263	16 x 1,8 - 1/2" (Ø16)		10/300
144 0009	16 x 2,0 - 1/2" (Ø16)		10/300
144 0006	16 x 2,2 - 1/2" (Ø16)		10/300

**1435K**

Pentru tub PEX

Adaptor pentru conexiuni
1/2"x16

Versiunea cromata

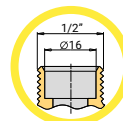

Cod	Dimensiune	Pret €	Ambalare
144 0141	12 x 1,1 - 1/2" (Ø16)		10/350
144 0142	12 x 2,0 - 1/2" (Ø16)		10/350
144 0143	14 x 2,0 - 1/2" (Ø16)		10/350
144 0144	15 x 2,5 - 1/2" (Ø16)		10/350
144 0145	16 x 1,5 - 1/2" (Ø16)		10/350
144 0022	16 x 2,0 - 1/2" (Ø16)		10/300
144 0146	16 x 2,2 - 1/2" (Ø16)		10/300

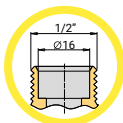
1435NAdaptor pentru conexiuni
1/2"x16. Pentru tub PEX

Cod	Dimensiune	Pret €	Ambalare
144 0113	12 x 1,1 - 1/2" (Ø16)		10/350
144 0058	12 x 2,0 - 1/2" (Ø16)		10/350
144 0068	14 x 2,0 - 1/2" (Ø16)		10/350
144 0007	15 x 2,5 - 1/2" (Ø16)		10/350
144 0098	16 x 1,5 - 1/2" (Ø16)		10/350
144 0264	16 x 1,8 - 1/2" (Ø16)		10/300
144 0004	16 x 2,0 - 1/2" (Ø16)		10/300
144 0037	16 x 2,2 - 1/2" (Ø16)		10/300

Până la terminarea stocului

**1635**

Pentru tub MULTISTRAT

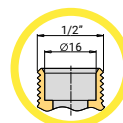
Adaptor pentru conexiuni
1/2"x16

Cod	Dimensiune	Pret €	Ambalare
144 0088	14 x 2,0 - 1/2" (Ø16)		10/350
144 0053	16 x 2,0 - 1/2" (Ø16)		10/300
144 0092	16 x 2,25 - 1/2" (Ø16)		10/300

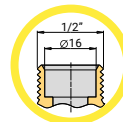
**1635N**Adaptor pentru conexiuni
1/2"x16. Pentru tub MULTISTRAT

Cod	Dimensiune	Pret €	Ambalare
144 0010	14 x 2,0 - 1/2" (Ø16)		10/350
144 0001	16 x 2,0 - 1/2" (Ø16)		10/300
144 0021	16 x 2,25 - 1/2" (Ø16)		10/300

Adaptor pentru conexiuni 1/2" (Ø16)

**1635K**

Pentru tub MULTISTRAT

Adaptor pentru conexiuni
1/2"x16

Versiunea cromata

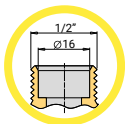

Cod	Dimensiune	Pret €	Ambalare
144 0114	14 x 2,0 - 1/2" (Ø16)		10/350
144 0041	16 x 2,0 - 1/2" (Ø16)		10/300
144 0170	16 x 2,25 - 1/2" (Ø16)		10/300

**1716**

Pentru tub PEX

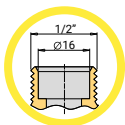
Racord drept cu piulita pentru
conexiuni 1/2"x16

Cod	Dimensiune	Pret €	Ambalare
170 0103	16 x 1,8 - 1/2" (Ø16)		10/100
170 0082	16 x 2,0 - 1/2" (Ø16)		10/100
170 0093	20 x 1,9 e 2,0 - 1/2" (Ø16)		10/100

**1668**

Pentru tub MULTISTRAT

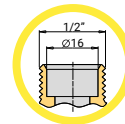
Racord drept cu piulita pentru
conexiuni 1/2"x16

Cod	Dimensiune	Pret €	Ambalare
165 0028	16 x 2,0 - 1/2" (Ø16)		10/100
165 0077	20 x 2,0 - 1/2" (Ø16)		10/100

NOUȚĂȚI

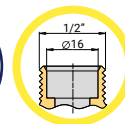
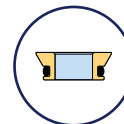
**1859A16**Adaptor pentru a transforma un
filet 1/2"x16 in filet cu fata plana

Cod	Dimensiune	Pret €	Ambalare
144 0311	1/2" (Ø16)		10/400

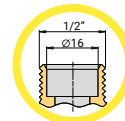
**1879**Racord terminal cu 1/2"x16-
3/4"x18 Eurocono conexiuni

Cod	Dimensiune	Pret €	Ambalare
144 0063	1/2" (Ø16)		10/300

Adaptor pentru conexiuni 3/4" (Ø18) (EUROCONO)

**1241N**

Pentru tub din CUPRU

Piulita si inel de compresie pentru conexiuni 3/4"x18 (EUROCONO)

Versiunea nichelata

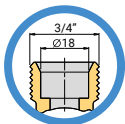

Cod	Dimensiune	Pret €	Ambalare
144 0072	10 - 3/4" (Ø18)		10/250
144 0030	12 - 3/4" (Ø18)		10/250
144 0034	14 - 3/4" (Ø18)		10/250
144 0008	15 - 3/4" (Ø18)		10/250
144 0027	16 - 3/4" (Ø18)		10/250
144 0018	18 - 3/4" (Ø18)		10/250

Până la terminarea stocului

**1241K**

Pentru tub din CUPRU

Piulita si inel de compresie pentru conexiuni 3/4"x18 (EUROCONO)

Versiunea cromata

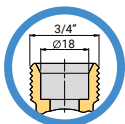

Cod	Dimensiune	Pret €	Ambalare
144 0129	10 - 3/4" (Ø18)		10/250
144 0107	12 - 3/4" (Ø18)		10/250
144 0130	14 - 3/4" (Ø18)		10/250
144 0131	15 - 3/4" (Ø18)		10/250
144 0132	16 - 3/4" (Ø18)		10/250
144 0123	18 - 3/4" (Ø18)		10/250

Până la terminarea stocului

**1436**

Pentru tub PEX

Adaptor pentru conexiuni 3/4"x18 (EUROCONO)

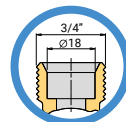

Cod	Dimensiune	Pret €	Ambalare
144 0147	12 x 2,0 - 3/4" (Ø18)		10/250
144 0120	14 x 2,0 - 3/4" (Ø18)		10/250
144 0148	15 x 2,5 - 3/4" (Ø18)		10/250
144 0118	16 x 1,5 - 3/4" (Ø18)		10/250
144 0265	16 x 1,8 - 3/4" (Ø18)		10/250
144 0099	16 x 2,0 - 3/4" (Ø18)		10/250
144 0149	16 x 2,2 - 3/4" (Ø18)		10/250
144 0085	17 x 2,0 - 3/4" (Ø18)		10/200
144 0121	18 x 2,0 - 3/4" (Ø18)		10/200
144 0150	18 x 2,5 - 3/4" (Ø18)		10/200
144 0089	20 x 2,0 - 3/4" (Ø18)		10/200
144 0151	20 x 2,8 - 3/4" (Ø18)		10/200

**1436N**

Adaptor pentru conexiuni 3/4"x18 (EUROCONO). Pentru tub PEX

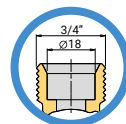

Cod	Dimensiune	Pret €	Ambalare
144 0254	12 x 1,1 - 3/4" (Ø18)		10/250
144 0054	12 x 2,0 - 3/4" (Ø18)		10/250
144 0059	14 x 2,0 - 3/4" (Ø18)		10/250
144 0078	15 x 1,5 - 3/4" (Ø18)		10/250
144 0036	15 x 2,5 - 3/4" (Ø18)		10/250
144 0042	16 x 1,5 - 3/4" (Ø18)		10/250
144 0255	16 x 1,8 - 3/4" (Ø18)		10/250
144 0011	16 x 2,0 - 3/4" (Ø18)		10/250
144 0047	16 x 2,2 - 3/4" (Ø18)		10/250
144 0012	17 x 2,0 - 3/4" (Ø18)		10/200
144 0043	18 x 2,0 - 3/4" (Ø18)		10/200
144 0052	18 x 2,5 - 3/4" (Ø18)		10/200
144 0019	20 x 2,0 - 3/4" (Ø18)		10/200
144 0056	20 x 2,8 - 3/4" (Ø18)		10/200

Adaptor pentru conexiuni 3/4" (Ø18) (EUROCONO)

**1436K**

Pentru tub PEX

Adaptor pentru conexiuni
3/4"x18 (EUROCONO)

Versiunea cromata

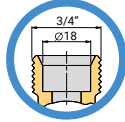

Cod	Dimensiune	Pret €	Ambalare
144 0152	12 x 2,0 - 3/4" (Ø18)		10/250
144 0153	14 x 2,0 - 3/4" (Ø18)		10/250
144 0154	15 x 2,5 - 3/4" (Ø18)		10/250
144 0155	16 x 1,5 - 3/4" (Ø18)		10/250
144 0156	16 x 2,0 - 3/4" (Ø18)		10/250
144 0157	16 x 2,2 - 3/4" (Ø18)		10/250
144 0158	17 x 2,0 - 3/4" (Ø18)		10/200
144 0159	18 x 2,0 - 3/4" (Ø18)		10/200
144 0160	18 x 2,5 - 3/4" (Ø18)		10/200
144 0161	20 x 2,0 - 3/4" (Ø18)		10/200
144 0162	20 x 2,8 - 3/4" (Ø18)		10/200

**1636**

Pentru tub MULTISTRAT

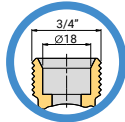
Adaptor pentru conexiuni
3/4"x18 (EUROCONO)

Cod	Dimensiune	Pret €	Ambalare
144 0171	14 x 2,0 - 3/4" (Ø18)		10/250
144 0080	16 x 2,0 - 3/4" (Ø18)		10/250
144 0119	16 x 2,25 - 3/4" (Ø18)		10/250
144 0172	17 x 2,0 - 3/4" (Ø18)		10/200
144 0122	18 x 2,0 - 3/4" (Ø18)		10/200
144 0100	20 x 2,0 - 3/4" (Ø18)		10/200
144 0173	20 x 2,25 - 3/4" (Ø18)		10/200
144 0174	20 x 2,5 - 3/4" (Ø18)		10/200

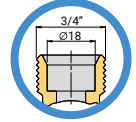
**1636N**Adaptor pentru conexiuni
3/4"x18 (EUROCONO). Pentru
tub MULTISTRAT

Cod	Dimensiune	Pret €	Ambalare
144 0045	14 x 2,0 - 3/4" (Ø18)		10/250
144 0002	16 x 2,0 - 3/4" (Ø18)		10/250
144 0055	16 x 2,25 - 3/4" (Ø18)		10/250
144 0231	16,2 x 2,6 - 3/4" (Ø18)		10/250
144 0033	17 x 2,0 - 3/4" (Ø18)		10/200
144 0014	18 x 2,0 - 3/4" (Ø18)		10/200
144 0003	20 x 2,0 - 3/4" (Ø18)		10/200
144 0023	20 x 2,25 - 3/4" (Ø18)		10/200
144 0038	20 x 2,5 - 3/4" (Ø18)		10/200

**1636K**

Pentru tub MULTISTRAT

Adaptor pentru conexiuni
3/4"x18 (EUROCONO)

Versiunea cromata

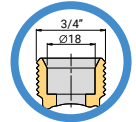

Cod	Dimensiune	Pret €	Ambalare
144 0175	14 x 2,0 - 3/4" (Ø18)		10/250
144 0110	16 x 2,0 - 3/4" (Ø18)		10/250
144 0176	16 x 2,25 - 3/4" (Ø18)		10/250
144 0177	17 x 2,0 - 3/4" (Ø18)		10/200
144 0178	18 x 2,0 - 3/4" (Ø18)		10/200
144 0109	20 x 2,0 - 3/4" (Ø18)		10/200
144 0179	20 x 2,25 - 3/4" (Ø18)		10/200
144 0180	20 x 2,5 - 3/4" (Ø18)		10/200

**1716**

Pentru tub PEX

Racord drept cu piulita pentru conexiuni 3/4"x18 (EUROCONO)

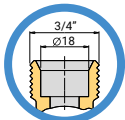

Cod	Dimensiune	Pret €	Ambalare
170 0321	12 x 1,1 - 3/4" (Ø18)		10/100
170 0137	16 x 1,5 - 3/4" (Ø18)		10/100
170 0090	16 x 1,8 - 3/4" (Ø18)		10/100
170 0086	16 x 2,0 - 3/4" (Ø18)		10/100
170 0352	17 x 2,0 - 3/4" (Ø18)		10/100
170 0089	20 x 1,9 e 2,0 - 3/4" (Ø18)		10/100
170 0081	25 x 2,3 - 3/4" (Ø18)		2/100

**1666**

Pentru tub MULTISTRAT

Racord drept cu piulita pentru conexiuni 3/4"x18 (EUROCONO)

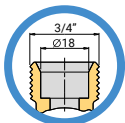

Cod	Dimensiune	Pret €	Ambalare
165 0076	16 x 2,0 - 3/4" (Ø18)		10/100
165 0110	20 x 2,0 - 3/4" (Ø18)		10/100

**1859**

Adaptor pentru a transforma un filet 3/4"x 18 (EUROCONO) in filet cu fata plana

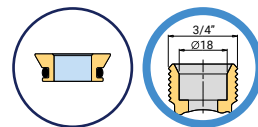

Cod	Dimensiune	Pret €	Ambalare
144 0104	3/4" (Ø18)		10/400

**1879**

Racord terminal

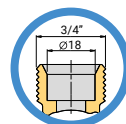

Cod	Dimensiune	Pret €	Ambalare
144 0071	3/4" (Ø18)		10/250

Adaptor pentru conexiuni 24 x 19 fil (ø18)

**1243K**

Pentru tub din CUPRU

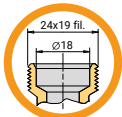
Piulita si inel de compresie pentru conexiuni 24x19 fil (ø 18)
Versiunea cromata

Cod	Dimensiune	Pret €	Ambalare
144 0115	10 - 24 x 19 fil (ø18)		10/250
144 0133	12 - 24 x 19 fil (ø18)		10/250
144 0117	14 - 24 x 19 fil (ø18)		10/250
144 0024	15 - 24 x 19 fil (ø18)		10/250
144 0032	16 - 24 x 19 fil (ø18)		10/250
144 0064	18 - 24 x 19 fil (ø18)		10/250

**1433K**

Pentru tub PEX

Adaptor pentru conexiuni 24x19 fil (ø 18)

Versiunea cromata

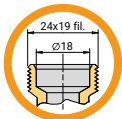

Disponibila la cerere versiunea galbena

Cod	Dimensiune	Pret €	Ambalare
144 0057	15 x 2,5 - 24 x 19 fil (ø18)		10/250
144 0262	16 x 1,5 - 24 x 19 fil (ø18)		10/250
144 0251	16 x 1,8 - 24 x 19 fil (ø18)		10/250
144 0015	16 x 2,0 - 24 x 19 fil (ø18)		10/250
144 0090	16 x 2,2 - 24 x 19 fil (ø18)		10/250
144 0250	17 x 2,0 - 24 x 19 fil (ø18)		10/250
144 0031	18 x 2,0 - 24 x 19 fil (ø18)		10/250
144 0044	18 x 2,5 - 24 x 19 fil (ø18)		10/250
144 0140	20 x 2,0 - 24 x 19 fil (ø18)		10/250

**1633K**

Pentru tub MULTISTRAT

Adaptor pentru conexiuni 24x19 fil (ø 18)

Versiunea cromata

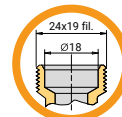

Cod	Dimensiune	Pret €	Ambalare
144 0228	14 x 2,0 - 24 x 19 fil (ø18)		10/250
144 0017	16 x 2,0 - 24 x 19 fil (ø18)		10/250
144 0235	16 x 2,25 - 24 x 19 fil (ø18)		10/250
144 0230	16,2 x 2,6 - 24 x 19 fil (ø18)		10/250
144 0048	18 x 2,0 - 24 x 19 fil (ø18)		10/250
144 0077	20 x 2,0 - 24 x 19 fil (ø18)		10/250
144 0266	20 x 2,25 - 24 x 19 fil (ø18)		10/250
144 0236	20 x 2,5 - 24 x 19 fil (ø18)		10/250

**1716**

Pentru tub PEX

Racord drept cu piulita pentru conexiuni 24x19 fil (ø 18)

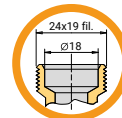

Cod	Dimensiune	Pret €	Ambalare
170 0118	16 x 1,8 - 24 x 19 fil (ø18)		10/100
170 0057	16 x 2,0 - 24 x 19 fil (ø18)		10/100
170 0138	18 x 2,0 - 24 x 19 fil (ø18)		10/100
170 0095	20 x 1,9 e 2,0 - 24 x 19 fil (ø18)		10/100

**1716K**

Pentru tub PEX

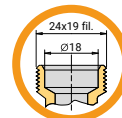
Racord drept cu piulita pentru conexiuni 24x19 fil (ø 18)
Versiunea cromata

Cod	Dimensiune	Pret €	Ambalare
170 0139	16 x 1,8 - 24 x 19 fil (ø18)		10/100
170 0063	16 x 2,0 - 24 x 19 fil (ø18)		10/100
170 0075	18 x 2,0 - 24 x 19 fil (ø18)		10/100
170 0140	20 x 1,9 e 2,0 - 24 x 19 fil (ø18)		10/100

Adaptor pentru conexiuni 24 x 19 fil ($\phi 18$)**1666K**

Pentru tub MULTISTRAT

Racord drept cu piulita pentru conexiuni 24x19 fil ($\phi 18$)

Versiunea cromata

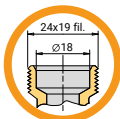

Cod	Dimensiune	Pret €	Ambalare
165 0158	16 x 2,0 - 24 x 19 fil ($\phi 18$)		10/100
165 0198	18 x 2,0 - 24 x 19 fil ($\phi 18$)		10/100
165 0272	20 x 2,0 - 24 x 19 fil ($\phi 18$)		10/100

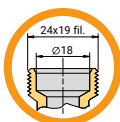
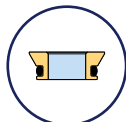
**1859**Adaptor pentru a transforma un filet 24x19 fil ($\phi 18$) in filet cu fata plana

Cod	Dimensiune	Pret €	Ambalare
144 0104	24 x 19 fil ($\phi 18$)		10/400

**1879K**

Racord terminal

Versiunea cromata

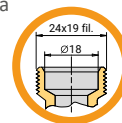

Cod	Dimensiune	Pret €	Ambalare
144 0211	24 x 19 fil ($\phi 18$)		1/250



ADAPTORI PENTRU TUB DE CUPRU - REF. - 1240 - 1241 - 1243

NUMARUL DE ROTATII PENTRU PIULITA					
Ø 10 - 1/2" (Ø16) 1-1/4=10 Nm	Ø 12 - 1/2" (Ø16) 1-1/4=10 Nm	Ø 14 - 1/2" (Ø16) 1-1/4=10 Nm	Ø 15 - 1/2" (Ø16) 1-1/4=12 Nm	Ø 16 - 1/2" (Ø16) 1-1/4=12 Nm	Ø 10 - 3/4" (Ø18) 1-1/4=9 Nm
Ø 12 - 3/4" (Ø18) 1-1/4=9 Nm	Ø 14 - 3/4" (Ø18) 1-1/4=9 Nm	Ø 15 - 3/4" (Ø18) 1-1/4=9 Nm	Ø 16 - 3/4" (Ø18) 1-1/4=12 Nm	Ø 18 - 3/4" (Ø18) 1-1/4=15 Nm	Ø 18 - 3/4" (Ø18) 1-1/4=15 Nm
Ø 10 - 24x19 fil (Ø18) 1-1/4=9 Nm	Ø 12 - 24x19 fil (Ø18) 1-1/4=9 Nm	Ø 14 - 24x19 fil (Ø18) 1-1/4=9 Nm	Ø 15 - 24x19 fil (Ø18) 1-1/4=25 Nm	Ø 18 - 24x19 fil (Ø18) 1-1/4=15 Nm	

DACA ESTE NECESAR SE MAI POT APLICA PANA LA 1/4-1/2 ROTATII ULTERIOARE

ADAPTORI PENTRU TUBURI PEX - REF. - 1433 - 1435 - 1436

NUMARUL DE ROTATII PENTRU PIULITA					
12x1,1 - 1/2" (Ø16) 1=25 Nm	12x2,0 - 1/2" (Ø16) 1=28 Nm	14x2,0 - 1/2" (Ø16) 1=28 Nm	15x2,5 - 1/2" (Ø16) 1=28 Nm	16x1,5 - 1/2" (Ø16) 1=28 Nm	16x1,8 - 1/2" (Ø16) 1=28 Nm
16x2,0 - 1/2" (Ø16) 1=29 Nm	16x2,2 - 1/2" (Ø16) 1=29 Nm	12x1,1 - 3/4" (Ø18) 1=23 Nm	12x2,0 - 3/4" (Ø18) 1=30 Nm	14x2,0 - 3/4" (Ø18) 1=30 Nm	15x1,5 - 3/4" (Ø18) 1=30 Nm
15x2,5 - 3/4" (Ø18) 1=30 Nm	16x1,5 - 3/4" (Ø18) 1=31 Nm	16x2,0 - 3/4" (Ø18) 1=32 Nm	16x2,2 - 3/4" (Ø18) 1=32 Nm	17x2,0 - 3/4" (Ø18) 1=40 Nm	18x2,0 - 3/4" (Ø18) 1=40 Nm
18x2,5 - 3/4" (Ø18) 1=40 Nm	20x2,0 - 3/4" (Ø18) 1=44 Nm	15x2,5 - 24x19 fil (Ø18) 1=30 Nm	16x1,5 - 24x19 fil (Ø18) 1=30 Nm	16x2,0 - 24x19 fil (Ø18) 1=32 Nm	16x2,2 - 24x19 fil (Ø18) 1=32 Nm
17x2,0 - 24x19 fil (Ø18) 1=40 Nm	18x2,0 - 24x19 fil (Ø18) 1=40 Nm	18x2,5 - 24x19 fil (Ø18) 1=40 Nm	20x2,0 - 24x19 fil (Ø18) 1=44 Nm		

ADAPTORI PENTRU TUBURI MULTISTRAT AL-COBRAPEX - REF. - 1633 - 1635 - 1636 - 1636N06

NUMARUL DE ROTATII PENTRU PIULITA					
14x2,0 - 1/2" (Ø16) 1=28 Nm	16x2,0 - 1/2" (Ø16) 1=30 Nm	16x2,25 - 1/2" (Ø16) 1=30 Nm	14x2,0 - 3/4" (Ø18) 1=30 Nm	16x2,0 - 3/4" (Ø18) 1=33 Nm	16x2,25 - 3/4" (Ø18) 1=33 Nm
17x2,0 - 3/4" (Ø18) 1=40 Nm	18x2,0 - 3/4" (Ø18) 1=40 Nm	20x2,0 - 3/4" (Ø18) 1=45 Nm	20x2,25 - 3/4" (Ø18) 1=45 Nm	20x2,5 - 3/4" (Ø18) 1=45 Nm	14x2,0 - 24x19 fil (Ø18) 1=30 Nm
16x2,0 - 24x19 fil (Ø18) 1=33 Nm	18x2,0 - 24x19 fil (Ø18) 1=40 Nm	20x2,0 - 24x19 fil (Ø18) 1=45 Nm	16x2,0 - 1" (Ø24) 1=35 Nm	20x2,0 - 1" (Ø24) 1=48 Nm	26x3,0 - 1" (Ø24) 1=53 Nm

12 ROBINETI PENTRU RADIATOARE



Robineți termostatzabili cu pre-reglare nichelați			231
Robineti termostatzabili			234
Robineti de retur			236
Robineti termostatzabili cromati			237
Robineti de retur termostatzabili cromati			238
Capete termostactice			239
Sisteme de termoreglare Wi-Fi	TIEMME GATE >>>		240
Sisteme de termoreglare wireless			241
Kit robineti termostatzabili cu pre-reglare			242
Kit robineti termostatzabili			243
TIEMME BOX			244
Robineti manuali seria "MAXIMA"			245
Robineti manuali seria "NEW EXCEL"			246
Robineti de retur seria "EXCEL"			248
Kit robineti manuali			249
Robineti si distribuitoare			250
Distribuitor bitub			253
Accesorii			254

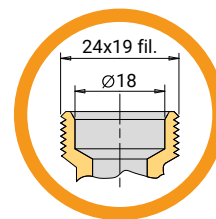
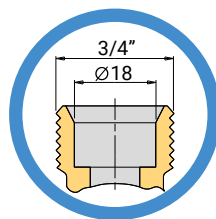
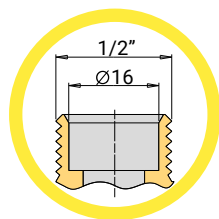

1668 (1/2")
 pentru tub multistrat
 Ø14x2,0
 Ø16x2,0
 Ø18x2,0
 Ø20x2,0

1666
 pentru tub multistrat
 Ø14x2,0
 Ø16x2,0
 Ø18x2,0
 Ø20x2,0

1666K24
 pentru tub multistrat
 Ø16x2,0
 Ø18x2,0
 Ø20x2,0

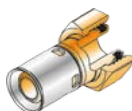

1716
 pentru tub Pex
 Ø16x1,8 Ø16x2,0
 Ø20x1,9 Ø20x2,0

1716
 pentru tub Pex
 Ø16x1,8 Ø16x2,0
 Ø20x1,9 Ø20x2,0
 Ø25x2,3

1716K
 pentru tub Pex
 Ø16x1,8 Ø16x2,0
 Ø20x1,9 Ø20x2,0

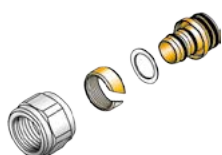

1635
 pentru tub multistrat
 Ø14x2,0 Ø16x2,0
 Ø16x2,25

1636
 pentru tub multistrat
 Ø14x2,0 Ø16x2,0
 Ø16x2,25 Ø17x2,0
 Ø18x2,0 Ø20x2,0
 Ø20x2,25 Ø20x2,5

1633K
 pentru tub multistrat
 Ø16x2,0 Ø16x2,25
 Ø18x2,0 Ø20x2,0
 Ø20x2,5



1435
 pentru tub Pex
 Ø12x1,1 Ø12x2,0
 Ø14x2,0 Ø15x2,5
 Ø16x1,5 Ø16x2,0
 Ø16x2,2

1436
 pentru tub Pex
 Ø12x2,0 Ø14x2,0 Ø15x1,5
 Ø15x2,5 Ø16x1,5 Ø16x2,0
 Ø16x2,2 Ø17x2,0 Ø18x2,0
 Ø18x2,5 Ø20x2,0 Ø20x2,8

1433K
 pentru tub Pex
 Ø15x2,5 Ø16x2,0
 Ø16x2,2 Ø17x2,0
 Ø18x2,0 Ø18x2,5
 Ø20x2,0



1233 - 1235
 pentru tub din cupru
 Ø10 - Ø12 - Ø14 - Ø16



1240
 pentru tub din cupru
 Ø10 - Ø12 - Ø14
 Ø15 - Ø16

1241
 pentru tub din cupru
 Ø10 - Ø12 - Ø14
 Ø15 - Ø16 - Ø18

1243K
 pentru tub din cupru
 Ø15 - Ø16 - Ø18



**331H**

Robinet de colț **TERMOSTATIZABIL CU PRE-REGLARE** cu racord pentru tub din fier. Dotat cu capac de protecție

**+ CU PRE-REGLARE**

Cod	Dimensiune	Pret €	Ambalare
331 0006	G 3/8"		10/60
331 0004	G 1/2"		10/60
331 0005	G 3/4"		10/60
Versiunea cu O-ring			
331 0035	G 3/8"		10/60
331 0033	G 1/2"		10/60
331 0034	G 3/4"		10/60

**331G**

Robinet drept **TERMOSTATIZABIL CU PRE-REGLARE** cu racord pentru tub din fier. Dotat cu capac de protecție

**+ CU PRE-REGLARE**

Cod	Dimensiune	Pret €	Ambalare
331 0001	G 3/8"		10/60
331 0002	G 1/2"		10/60
331 0003	G 3/4"		10/60
Versiunea cu O-ring			
331 0030	G 3/8"		10/60
331 0031	G 1/2"		10/60
331 0032	G 3/4"		10/60

**332H**

Robinet de colț **TERMOSTATIZABIL CU PRE-REGLARE** cu racord pentru tub din cupru/ PEX/ multistrat. Dotat cu capac de protecție

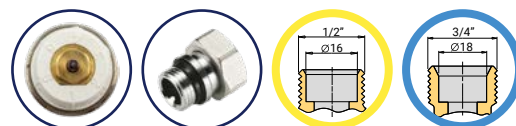
**+ CU PRE-REGLARE**

Cod	Dimensiune	Iesiri	Pret €	Ambalare
331 0014	G 3/8"	1/2" (ø16)		10/60
331 0015	G 1/2"	1/2" (ø16)		10/60
331 0016	G 3/8"	3/4" (ø18)		10/60
331 0017	G 1/2"	3/4" (ø18)		10/60
Versiunea cu O-ring				
331 0022	G 3/8"	1/2" (ø16)		10/60
331 0023	G 1/2"	1/2" (ø16)		10/60
331 0024	G 3/8"	3/4" (ø18)		10/60
331 0025	G 1/2"	3/4" (ø18)		10/60

**332G**

Robinet drept **TERMOSTATIZABIL CU PRE-REGLARE** cu racord pentru tub din cupru/ PEX/ multistrat. Dotat cu capac de protecție

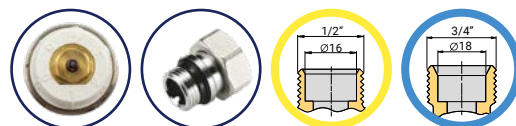
**+ CU PRE-REGLARE**

Cod	Dimensiune	Iesiri	Pret €	Ambalare
331 0018	G 3/8"	1/2" (ø16)		10/60
331 0019	G 1/2"	1/2" (ø16)		10/60
331 0020	G 3/8"	3/4" (ø18)		10/60
331 0021	G 1/2"	3/4" (ø18)		10/60
Versiunea cu O-ring				
331 0026	G 3/8"	1/2" (ø16)		10/60
331 0027	G 1/2"	1/2" (ø16)		10/60
331 0028	G 3/8"	3/4" (ø18)		10/60
331 0029	G 1/2"	3/4" (ø18)		10/60

**3313**

Robinet TERMOSTATIZABIL CU PRE-REGLARE prindere reversibila

CU PRE-REGLARE

Cod	Dimensiune	Pret €	Ambalare
331 0009	G 1/2"		10/60
Versiunea cu O-ring			
331 0010	G 1/2"		10/60

**3312**

Robinet TERMOSTATIZABIL CU PRE-REGLARE prindere coaxial stanga pentru conectare pe tub de cupru/ PEX/ multistrat. versiune cu capac de protectie

CU PRE-REGLARE

Cod	Dimensiune	Iesiri	Pret €	Ambalare
331 0007	G 1/2"	3/4"(ϕ 18)		10/60
Versiunea cu O-ring				
331 0008	G 1/2"	3/4"(ϕ 18)		10/60

**3228DX**

Robinet TERMOSTATIZABIL CU PRE-REGLARE prindere coaxial dreapta pentru conectare pe tub de fier.versiune cu capac de protectie

CU PRE-REGLARE

Cod	Dimensiune	Pret €	Ambalare
330 0128	G 3/8"		10/60
330 0123	G 1/2"		10/60
Versiunea cu O-ring			
330 0125	G 1/2"		10/60

**3228SX**

Robinet TERMOSTATIZABIL CU PRE-REGLARE prindere coaxial stanga pentru conectare pe tub de fier.versiune cu capac de protectie

CU PRE-REGLARE

Cod	Dimensiune	Pret €	Ambalare
330 0129	G 3/8"		10/60
330 0124	G 1/2"		10/60
Versiunea cu O-ring			
330 0126	G 1/2"		10/60



**3227DX**

Robinet TERMOSTATIZABIL CU PRE-REGLARE prindere coaxial dreapta pentru conectare pe tub de cupru/ PEX/ multistrat. versiune cu capac de protecție



+ CU PRE-REGLARE

Cod	Dimensiune	Iesiri	Pret €	Ambalare
330 0119	G 1/2"	3/4"(ϕ 18)		10/60
Versiunea cu O-ring				
330 0121	G 1/2"	3/4"(ϕ 18)		10/60

**3227SX**

Robinet TERMOSTATIZABIL CU PRE-REGLARE prindere coaxial stanga pentru conectare pe tub de cupru/ PEX/ multistrat. versiune cu capac de protecție



+ CU PRE-REGLARE

Cod	Dimensiune	Iesiri	Pret €	Ambalare
330 0120	G 1/2"	3/4"(ϕ 18)		10/60
Versiunea cu O-ring				
330 0122	G 1/2"	3/4"(ϕ 18)		10/60

INSTRUCȚIUNI PENTRU UN REGLAJ CORECT

1



Deșurubați capacul de pe corpul robinetului

2

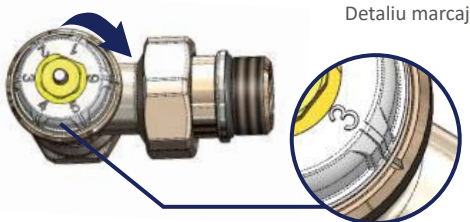

Rotiți butonul numerotat până când numărul corespunzător Kv-ului dorit (vezi tabel) este aliniat cu marcajul de referință de pe corpul robinetului.

TABEL KV

Pozitie		Kv (m ³ /h)
1		0,09
2		0,14
3		0,20
4		0,30
5		0,55
6		0,80

**3306**

Robinet de colt termostaticabil pentru montare pe tub de fier



Cod	Dimensiune	Pret €	Ambalare
330 0023	G 3/8"		10/60
330 0005	G 1/2"		10/60
330 0022	G 3/4"		10/60
Versiunea cu O-ring			
330 0029	G 3/8"		10/60
330 0026	G 1/2"		10/60
330 0053	G 3/4"		10/60

**3305**

Robinet drept termostaticabil pentru montare pe tub de fier



Cod	Dimensiune	Pret €	Ambalare
330 0050	G 3/8"		10/60
330 0013	G 1/2"		10/60
330 0015	G 3/4"		10/60
Versiunea cu O-ring			
330 0040	G 3/8"		10/60
330 0035	G 1/2"		10/60
330 0049	G 3/4"		10/60

**3301**

Robinet de colt termostaticabil pentru conectare pe tub de cupru/PEX/multistrat.

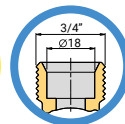
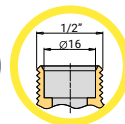

Cod	Dim.	Iesiri	Pret €	Ambalare
330 0017	G 3/8"	1/2" (Ø16)		10/60
330 0002	G 1/2"	1/2" (Ø16)		10/60
330 0066	G 3/8"	3/4" (Ø18)		10/60
330 0046	G 1/2"	3/4" (Ø18)		10/60
Versiunea cu O-ring				
330 0011	G 3/8"	1/2" (Ø16)		10/60
330 0003	G 1/2"	1/2" (Ø16)		10/60
330 0071	G 3/8"	3/4" (Ø18)		10/60
330 0051	G 1/2"	3/4" (Ø18)		10/60

**3300**

Robinet drept termostaticabil pentru conectare pe tub de cupru/PEX/multistrat

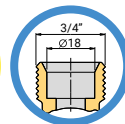
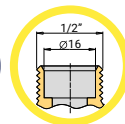

Cod	Dim.	Iesiri	Pret €	Ambalare
330 0058	G 3/8"	1/2" (Ø16)		10/60
330 0032	G 1/2"	1/2" (Ø16)		10/60
330 0079	G 3/8"	3/4" (Ø18)		10/60
330 0065	G 1/2"	3/4" (Ø18)		10/60
Versiunea cu O-ring				
330 0048	G 3/8"	1/2" (Ø16)		10/60
330 0036	G 1/2"	1/2" (Ø16)		10/60
330 0082	G 3/8"	3/4" (Ø18)		10/60
330 0083	G 1/2"	3/4" (Ø18)		10/60

**3308**

Robinet de colt termostaticabil pentru montare pe tub de fier.
Cu capac de protecție



Cod	Dimensiune	Pret €	Ambalare
330 0031	G 3/8"		10/60
330 0001	G 1/2"		10/60
330 0027	G 3/4"		10/60
Versiunea cu O-ring			
330 0057	G 3/8"		10/60
330 0055	G 1/2"		10/60
330 0075	G 3/4"		10/60

**3307**

Robinet drept termostaticabil pentru montare pe tub de fier.
Cu capac de protecție



Cod	Dimensiune	Pret €	Ambalare
330 0047	G 3/8"		10/60
330 0012	G 1/2"		10/60
330 0007	G 3/4"		10/60
Versiunea cu O-ring			
330 0069	G 3/8"		10/60
330 0074	G 1/2"		10/60
330 0063	G 3/4"		10/60

**3303**

Robinet de colt termostaticabil pentru conectare pe tub de cupru/PEX/multistrat.
Cu capac de protecție

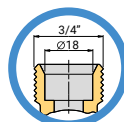
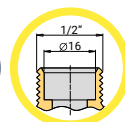

Cod	Dimensiune	Iesiri	Pret €	Ambalare
330 0019	G 3/8"	1/2" (Ø16)		10/60
330 0006	G 1/2"	1/2" (Ø16)		10/60
330 0067	G 3/8"	3/4" (Ø18)		10/60
330 0038	G 1/2"	3/4" (Ø18)		10/60
Versiunea cu O-ring				
330 0064	G 3/8"	1/2" (Ø16)		10/60
330 0028	G 1/2"	1/2" (Ø16)		10/60
330 0088	G 3/8"	3/4" (Ø18)		10/60
330 0076	G 1/2"	3/4" (Ø18)		10/60

**3302**

Robinet drept termostaticabil pentru conectare pe tub de cupru/PEX/multistrat.
Cu capac de protecție

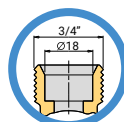
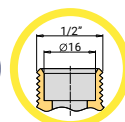

Cod	Dimensiune	Iesiri	Pret €	Ambalare
330 0070	G 3/8"	1/2" (Ø16)		10/60
330 0034	G 1/2"	1/2" (Ø16)		10/60
330 0080	G 3/8"	3/4" (Ø18)		10/60
330 0073	G 1/2"	3/4" (Ø18)		10/60
Versiunea cu O-ring				
330 0078	G 3/8"	1/2" (Ø16)		10/60
330 0068	G 1/2"	1/2" (Ø16)		10/60
330 0087	G 3/8"	3/4" (Ø18)		10/60
330 0081	G 1/2"	3/4" (Ø18)		10/60



3336
Robinet de retur de colt pentru montare pe tub de fier



Cod	Dimensiune	Pret €	Ambalare
333 0014	G 3/8"		10/60
333 0006	G 1/2"		10/60
333 0011	G 3/4"		10/60
333 0050	G 1/2"		1/60
333 0052	G 3/4"		1/60
Versiunea cu O-ring			
333 0015	G 3/8"		10/60
333 0010	G 1/2"		10/60
333 0017	G 3/4"		10/60
333 0051	G 1/2"		1/60
333 0053	G 3/4"		1/60

versiune cromata



3335
Robinet de retur drept pentru montare pe tub de fier



Cod	Dimensiune	Pret €	Ambalare
333 0027	G 3/8"		10/60
333 0009	G 1/2"		10/60
333 0004	G 3/4"		10/60
333 0046	G 1/2"		1/60
333 0048	G 3/4"		1/60
Versiunea cu O-ring			
333 0024	G 3/8"		10/60
333 0026	G 1/2"		10/60
333 0031	G 3/4"		10/60
333 0047	G 1/2"		1/60
333 0049	G 3/4"		1/60

versiune cromata



3331
Robinet de retur de colt pentru conectare pe tub de cupru/PEX/multistrat

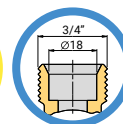
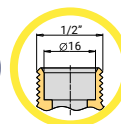

Cod	Dim.	Iesiri	Pret €	Ambalare
333 0007	G 3/8"	1/2" (Ø16)		10/60
333 0002	G 1/2"	1/2" (Ø16)		10/60
333 0033	G 3/8"	3/4" (Ø18)		10/60
333 0013	G 1/2"	3/4" (Ø18)		10/60
Versiunea cu O-ring				
333 0008	G 3/8"	1/2" (Ø16)		10/60
333 0003	G 1/2"	1/2" (Ø16)		10/60
333 0029	G 3/8"	3/4" (Ø18)		10/60
333 0025	G 1/2"	3/4" (Ø18)		10/60



3330
Robinet de retur drept pentru conectare pe tub de cupru/PEX/multistrat

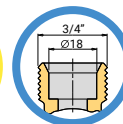
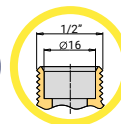

Cod	Dim.	Iesiri	Pret €	Ambalare
333 0032	G 3/8"	1/2" (Ø16)		10/60
333 0021	G 1/2"	1/2" (Ø16)		10/60
333 0038	G 3/8"	3/4" (Ø18)		10/60
333 0019	G 1/2"	3/4" (Ø18)		10/60
Versiunea cu O-ring				
333 0030	G 3/8"	1/2" (Ø16)		10/60
333 0023	G 1/2"	1/2" (Ø16)		10/60
333 0041	G 3/8"	3/4" (Ø18)		10/60
333 0028	G 1/2"	3/4" (Ø18)		10/60



**3306C**

Robinet de colt termostaticabil
pentru montare pe tub de fier.
versiune cromata lucioasa

Cod	Dimensiune	Pret €	Ambalare
330 0061	G 3/8"		10/60
330 0016	G 1/2"		10/60

**3305C**

Robinet drept termostaticabil
pentru montare pe tub de fier.
versiune cromata lucioasa

Cod	Dimensiune	Pret €	Ambalare
330 0060	G 3/8"		10/60
330 0025	G 1/2"		10/60

**3301C**

Robinet de colt termostaticabil
pentru conectare pe tub de
cupru/PEX/multistrat.
versiune cromata lucioasa

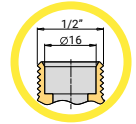

Cod	Dimensiune	Iesiri	Pret €	Ambalare
330 0042	G 3/8"	1/2" (ø16)		10/60
330 0009	G 1/2"	1/2" (ø16)		10/60

**3300C**

Robinet drept termostaticabil
pentru conectare pe tub de
cupru/PEX/multistrat.
versiune cromata lucioasa

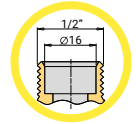

Cod	Dimensiune	Iesiri	Pret €	Ambalare
330 0059	G 3/8"	1/2" (ø16)		10/60
330 0041	G 1/2"	1/2" (ø16)		10/60

**3336C**

Robinet de retur de colt pentru montare pe tub de fier.
versiune cromata lucioasa

Cod	Dimensiune	Pret €	Ambalare
333 0035	G 3/8"		10/60
333 0001	G 1/2"		10/60

**3335C**

Robinet de retur drept pentru montare pe tub de fier.
versiune cromata lucioasa

Cod	Dimensiune	Pret €	Ambalare
333 0034	G 3/8"		10/60
333 0012	G 1/2"		10/60

**3331C**

Robinet de retur de colt pentru conectare pe tub de cupru/PEX/multistrat.
versiune cromata lucioasa

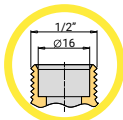

Cod	Dimensiune	lesiri	Pret €	Ambalare
333 0016	G 3/8"	1/2"(Ø16)		10/60
333 0005	G 1/2"	1/2"(Ø16)		10/60

**3330C**

Robinet de retur drept pentru conectare pe tub de cupru/PEX/multistrat.
versiune cromata lucioasa

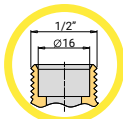

Cod	Dimensiune	lesiri	Pret €	Ambalare
333 0036	G 3/8"	1/2"(Ø16)		10/60
333 0018	G 1/2"	1/2"(Ø16)		10/60

**1240C**

Pentru tub din cupru
Piulita cromata + inel de compresie pentru conexiuni 1/2" x 16

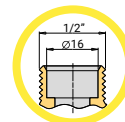

Cod	Dimensiune	Pret €	Ambalare
144 0084	10 x 1/2"(Ø16)		10/400
144 0050	12 x 1/2"(Ø16)		10/400
144 0067	14 x 1/2"(Ø16)		10/400
144 0066	15 x 1/2"(Ø16)		10/400

**1635C**

Pentru tub multistrat
Adaptor cromat pentru conexiuni 1/2" x 16

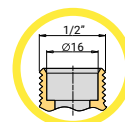

Cod	Dimensiune	Pret €	Ambalare
144 0065	14 x 2,0 - 1/2"(Ø16)		10/350
144 0035	16 x 2,0 - 1/2"(Ø16)		10/300
144 0079	16 x 2,25 - 1/2"(Ø16)		10/300



9553
Cap termostatic cu element sensibil cu lichid incorporat (6-28 °C)

Cod	Dimensiune	Pret €	Ambalare
955 0025	M30 x 1,5		1/30



9553C
Cap termostatic cu element sensibil cu lichid incorporat. Cromat (6-28 °C)

Cod	Dimensiune	Pret €	Ambalare
955 0026	M30 x 1,5		1/30



9558
Cap termostatic cu element sensibil cu lichid la distanta (lungime capilar 2 m)

Cod	Dimensiune	Pret €	Ambalare
955 0003	M30 x 1,5		1/15



9551
Cap termostatic cu comanda la distanta. Lungime capilar 2 m

Cod	Dimensiune	Pret €	Ambalare
955 0029	M30 x 1,5		1/5



9553INS
Pereche de placute pentru limitarea temperaturii pentru cap termostatic 9553/9553C

Cod	Dimensiune	Pret €	Ambalare
955 0037	-		5/50



9553AM2
Kit antivandalizare și antideteriorare pentru cap termostatic 9553/9553C

Cod	Dimensiune	Pret €	Ambalare
955 0033	-		20/80



9553CHT
Cheie pentru kit antivandalism protecție cap termostatic 9553/9553C

Cod	Dimensiune	Pret €	Ambalare
955 0038	-		1/1



9553AM1
Maneta antivandalizare și antideteriorare pentru cap termostatic 9553/9553C

Cod	Dimensiune	Pret €	Ambalare
955 0036	-		1/4



9556
Cap termostatic electronic programabil. Interval de temperatura 8-28 °C

Cod	Dimensiune	Pret €	Ambalare
955 0015	M30 x 1,5		1/5



9556USB
Cheie USB pentru programarea capului termostatic electronic

Cod	Dimensiune	Pret €	Ambalare
955 0017	-		10/40

12 SISTEME DE TERMOREGLARE WI-FI

TIEMME GATE

NOU TATI



9564W

Cap termostatic electronic comunicare Wi-Fi. Sistemul „Tiemme GATE”. Domeniu de temperatura 6-28o C

CARACTERISTICI TEHNICE:

- Alimentarea: nr. 2 baterii 1,5 V tip AA
- Funcționarea: ON, OFF, manuală, în regim automat
- Domeniu de reglare: +6oC÷28oC
- Tip conexiune: M30 x 1,5
- Adaptorii pentru toate tipurile de robineti uzuali prezenti pe piata
- Banda de frecvență Wi-Fi: 2,4 GHz

Cod	Dimensiune	Pret €	Ambalare
955 0052	M30 x 1,5		1/4

NOU TATI



9564ST

Sonda de temperatură cu Wi-Fi. Sistemul „TIEMME GATE”

CARACTERISTICI TEHNICE:

- Alimentarea: nr. 2 baterii 1,5 V tip AA
- Domeniu de reglare: 0 °C ÷ +50 °C
- Banda de frecvență Wi-Fi: 2,4 GHz

Cod	Dimensiune	Pret €	Ambalare
955 0053	0 °C ÷ + 50 °C		1/10

NOU TATI



9564RS

Releu cu Wi-Fi. Sistemul „TIEMME GATE”

CARACTERISTICI TEHNICE:

- Alimentarea: 85 ÷ 230 Vac 50/60 Hz
- Iesire releu de contact: 5 A 230 V
- Control tip “OpenTherm” catre centrala termica
- Banda de frecvență cu Wi-Fi: 2,4 GHz

Cod	Dimensiune	Pret €	Ambalare
955 0054	-		1/10



Disponibil pentru



9564W-9564ST-9564RS EXEMPLU DE INSTALARE

SISTEM CENTRALIZAT

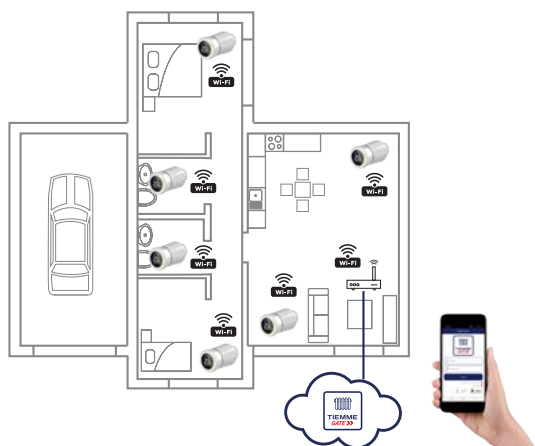

SISTEM AUTONOM

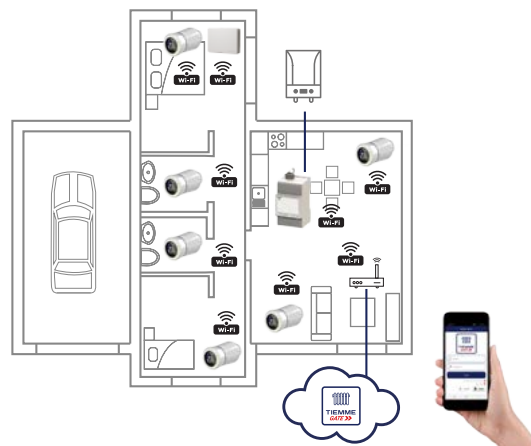

**9556W**

Cap termostatic electronic programabil wireless. Interval de temperatura 8-28 °C

Cod	Dimensiune	Pret €	Ambalare
955 0027	M30 x 1,5		1/5

**4601**

Termostat de ambient electronic cu trasmisie via radio

CARACTERISTICI TEHNICE:

- Display cu touchscreen
- Alimentare: 2 baterii AAA de 1,5 V
- Durata bateriei: 1 an
- Frecventa de transmisie: 433,92 MHz
- Functie VARA-IARNA-OFF
- Domeniu de reglare: 2-35°C
- Grad de precizie: reglabil de la +0,1 la +1°C (default+ 0,3°C)

Cod	Dimensiune	Pret €	Ambalare
957 0156	Electronic		1/10

**9580W**

Cronotermostat de ambient electronic cu touchscreen cu transmisie via radio

CARACTERISTICI TEHNICE:

- Display cu touchscreen
- Alimentare: 2 baterii AAA de 1,5 V
- Durata bateriei: 1 an
- Frecventa de transmisie: 433,92 MHz
- Iesire: in releu, liber de contact 5 A (230 Vac)
- Functie VARA-IARNA-OFF
- Programare saptamanala cu trei niveluri de temperatura
- Domeniu de reglare: 2-35°C
- Grad de precizie: reglabil de la $\pm 0,1$ la $\pm 1^\circ\text{C}$ (default+ 0,3°C)

Cod	Dimensiune	Pret €	Ambalare
957 0172	Electronic		1/10

 Cronotermostat disponibil art.9590 poate fi gestionat de la distanta prin aplicatie (vezi cap. 14)

9556W-4601-9580W**EXEMPLU DE INSTALARE**

Robinet termostaticabil cu pre-reglare, cap termostatic și robinet de retur (versiunea cu O-ring)

**331HKIT01**

Kit 3 piese compus din: robinet de colt TERMOSTATAT CU PRE-REGLARE, cap termostatic, robinet de retur cu racord pentru teava din fier



CU PRE-REGLARE

Cod	Dimensiune	Pret €	Ambalare
331 0046	G 3/8"		1/10
331 0047	G 1/2"		1/10
331 0048	G 3/4"		1/10

**332HKIT01**

Kit 3 piese compus din: robinet de colt TERMOSTATAT CU PRE-REGLARE, cap termostatic, robinet de retur cu racord pentru tub din cupru, Pex si multistrat

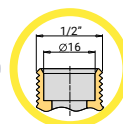

CU PRE-REGLARE

Cod	Dimensiune	Iesiri	Pret €	Ambalare
331 0052	G 3/8"	1/2"(Ø16)		1/10
331 0053	G 1/2"	1/2"(Ø16)		1/10

Robinet termostaticabil cu pre-reglare, cap termostatic și robinet de retur "EXCEL" (versiunea cu O-ring)

**331HKIT**

Kit 3 piese compus din: robinet de colt TERMOSTATAT CU PRE-REGLARE, cap termostatic, robinet de retur EXCEL cu racord pentru teava din fier



CU PRE-REGLARE

Cod	Dimensiune	Pret €	Ambalare
331 0036	G 3/8"		1/10
331 0037	G 1/2"		1/10
331 0045	G 3/4"		1/10

**332HKIT**

Kit 3 piese compus din: robinet de colt TERMOSTATAT CU PRE-REGLARE, cap termostatic, robinet de retur EXCEL cu racord pentru tub din cupru, Pex si multistrat

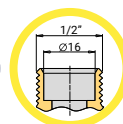

CU PRE-REGLARE

Cod	Dimensiune	Iesiri	Pret €	Ambalare
331 0040	G 3/8"	1/2"(Ø16)		1/10
331 0041	G 1/2"	1/2"(Ø16)		1/10



Robinet termostaticabil, cap termostatic, si robinet de retur "EXCEL" (versiune cu O-ring)



3308KIT04 3308KIT04R

Kit 3 piese compus din: robinet termostaticabil de colt, cap termostatic, robinet de retur EXCEL cu racord pentru teava din fier

Cod	Dimensiune	Pret €	Ambalare
330 0177	G 1/2"		1/20
Versiunea cu O-ring			
330 0153	G 1/2"		1/20



3303KIT04 3303KIT04R

Kit 3 piese compus din: robinet termostaticabil de colt, cap termostatic, robinet de retur EXCEL cu racord pentru tub din cupru, Pex si multistrat

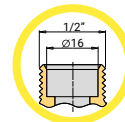

Cod	Dimensiune	Iesiri	Pret €	Ambalare
330 0178	G 3/8"	1/2"(ø16)		1/20
Versiunea cu O-ring				
330 0155	G 1/2"	1/2"(ø16)		1/20



4490
TIEMME BOX 1 pentru
reglarea incalzirii in functie de
temperatura ambientala

Cod	Dimensiune	Pret €	Ambalare
449 0001	3/4" (ø18)		1/4



4490C
TIEMME BOX 1 pentru
reglarea incalzirii in functie de
temperatura ambientala.
Versiunea cromata

Cod	Dimensiune	Pret €	Ambalare
449 0021	3/4" (ø18)		1/4

4490 - 4490C EXEMPLU DE UTILIZARE

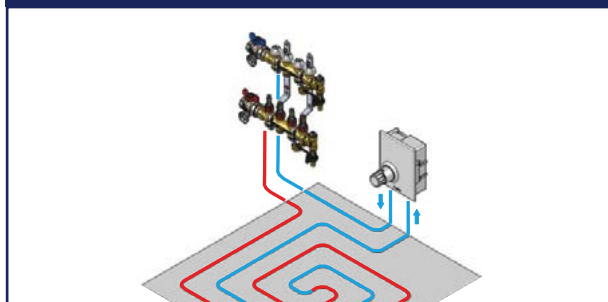

4491
TIEMME BOX 2 pentru limitarea
temperaturii de retur a
circuitului de incalzire (RTL)

Cod	Dimensiune	Pret €	Ambalare
449 0002	3/4" (ø18)		1/4



4491C
TIEMME BOX 2 pentru limitarea
temperaturii de retur a
circuitului de incalzire (RTL).
Versiunea cromata

Cod	Dimensiune	Pret €	Ambalare
449 0022	3/4" (ø18)		1/4

4491 - 4491C EXEMPLU DE UTILIZARE

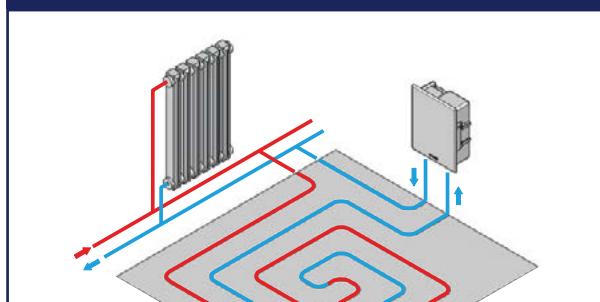

4492
TIEMME BOX 3 pentru
reglarea incalzirii in functie
de temperatura ambientala si
limitarea temperaturii de retur a
circuitului de incalzire (RTL)

Cod	Dimensiune	Pret €	Ambalare
449 0003	3/4" (ø18)		1/4



4492C
TIEMME BOX 3 pentru
reglarea incalzirii in functie
de temperatura ambientala si
limitarea temperaturii de retur
a circuitului de incalzire (RTL).
Versiunea cromata

Cod	Dimensiune	Pret €	Ambalare
449 0023	3/4" (ø18)		1/4

4492 - 4492C EXEMPLU DE UTILIZARE

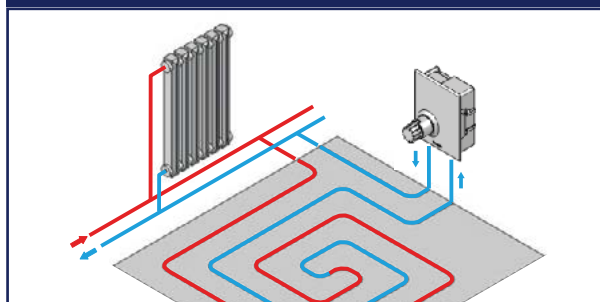

**3326**

Robinet manual SERIA MAXIMA de tur de colt pentru conectare pe tub de fier



Cod	Dimensiune	Pret €	Ambalare
332 0001	G 1/2"		1/60
332 0008	G 3/4"		1/60
Versiunea cu O-ring			
332 0010	G 1/2"		1/60
332 0012	G 3/4"		1/60

**3325**

Robinet manual SERIA MAXIMA de tur drept pentru conectare pe tub de fier



Cod	Dimensiune	Pret €	Ambalare
332 0003	G 1/2"		1/60
332 0009	G 3/4"		1/60
Versiunea cu O-ring			
332 0011	G 1/2"		1/60
332 0014	G 3/4"		1/60

**3321**

Robinet manual SERIA MAXIMA de tur de colt montare conectare pe tub de cupru/Pex/multistrat

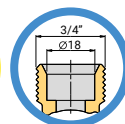
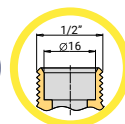

Cod	Dim.	Iesiri	Pret €	Ambalare
332 0034	G 1/2"	1/2"(ϕ 16)		10/60
332 0036	G 1/2"	3/4"(ϕ 18)		10/60
Versiunea cu O-ring				
332 0006	G 1/2"	1/2"(ϕ 16)		10/60
332 0037	G 1/2"	3/4"(ϕ 18)		10/60

**3320**

Robinet manual SERIA MAXIMA de tur drept pentru montare pe tub de cupru/Pex/multistrat

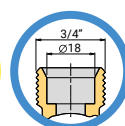
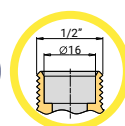

Cod	Dim.	Iesiri	Pret €	Ambalare
332 0028	G 1/2"	1/2"(ϕ 16)		10/60
332 0031	G 1/2"	3/4"(ϕ 18)		10/60
Versiunea cu O-ring				
332 0029	G 1/2"	1/2"(ϕ 16)		10/60
332 0032	G 1/2"	3/4"(ϕ 18)		10/60

**3266**

Robinet manual de tur de colt pentru montare pe tub de fier



Cod	Dimensiune	Pret €	Ambalare
326 0037	G 3/8"		10/60
326 0038	G 1/2"		10/60
326 0039	G 3/4"		10/60
Versiunea cu O-ring			
326 0047	G 3/8"		10/60
326 0040	G 1/2"		10/60
326 0041	G 3/4"		10/60

**3266PTFE**

Robinet manual de tur de colt pentru conectare pe tub de fier. SEMIOLANDEZ CU GARNITURA PTFE



Cod	Dimensiune	Pret €	Ambalare
326 0111	G 1/2"		10/60

Pina la terminarea stocului

**3265**

Robinet manual de tur drept pentru montare pe tub de fier



Cod	Dimensiune	Pret €	Ambalare
326 0042	G 3/8"		10/60
326 0043	G 1/2"		10/60
326 0044	G 3/4"		10/60
Versiunea cu O-ring			
326 0048	G 3/8"		10/60
326 0045	G 1/2"		10/60
326 0046	G 3/4"		10/60

**3263**

Robinet de tur-coltar, serie NEW EXCEL pentru conectare pe tub de cupru prin sudura



Cod	Dim.	Iesiri	Pret €	Ambalare
326 0053	G 1/2"	Ø 15		10/60
Versiunea cu O-ring				
326 0106	G 1/2"	Ø 15		10/60

**3261**

Robinet manual de tur de colt pentru conectare pe tub de cupru/Pex/multistrat

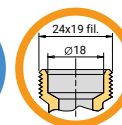
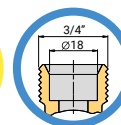
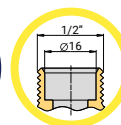

Cod	Dim.	Iesiri	Pret €	Ambalare
326 0029	G 3/8"	1/2" (Ø16)		10/60
326 0030	G 1/2"	1/2" (Ø16)		10/60
326 0105	G 1/2"	3/4" (Ø18)		1/60
326 0049	G 1/2"	24 x 19 fil (Ø18)		1/60
326 0082	G 3/4"	24 x 19 fil (Ø18)		1/60
Versiunea cu O-ring				
326 0031	G 3/8"	1/2" (Ø16)		10/60
326 0032	G 1/2"	1/2" (Ø16)		10/60
326 0050	G 1/2"	24 x 19 fil (Ø18)		1/60
326 0083	G 3/4"	24 x 19 fil (Ø18)		1/60

versiune cromata



**3261PTFE**

Robinet manual de tur de colt pentru conectare pe tub de cupru/Pex/multistrat. SEMIOLANDEZ CU GARNITURA PTFE

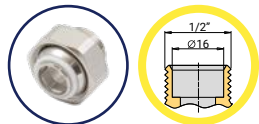

Cod	Dim.	Iesiri	Pret €	Ambalare
326 0112	G 1/2"	1/2" (ø16)		10/60

Pina la terminarea stocului

**3260**

Robinet manual de tur drept pentru montare pe tub de cupru/Pex/multistrat

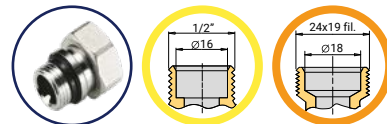

Cod	Dim.	Iesiri	Pret €	Ambalare
326 0033	G 3/8"	1/2" (ø16)		10/60
326 0034	G 1/2"	1/2" (ø16)		10/60
326 0051	G 1/2"	24 x 19 fil (ø18)		1/60
Versiunea cu O-ring				
326 0035	G 3/8"	1/2" (ø16)		10/60
326 0036	G 1/2"	1/2" (ø16)		10/60
326 0052	G 1/2"	24 x 19 fil (ø18)		1/60

versiune cromata

**3236EXCEL**

Robinet de retur de colt pentru montare pe tub de fier



Cod	Dimensiune	Pret €	Ambalare
323 0009	G 3/8"		10/60
323 0001	G 1/2"		10/60
323 0027	G 1/2"		10/60
323 0013	G 3/4"		10/60
Versiunea cu O-ring			
323 0041	G 3/8"		10/60
323 0008	G 1/2"		10/60
323 0023	G 3/4"		10/60

Cu capac nichelat

Versiunea cromata

**3236EXPTFE**

Robinet de retur de tur de colt pentru conectare pe tub de fier. SEMIOLANDEZ CU GARNITURA PTFE



Cod	Dimensiune	Pret €	Ambalare
323 0056	G 1/2"		10/60

Pina la terminarea stocului

**3235EXCEL**

Robinet de retur drept pentru montare pe tub de fier



Cod	Dimensiune	Pret €	Ambalare
323 0010	G 3/8"		10/60
323 0003	G 1/2"		10/60
323 0014	G 3/4"		10/60
Versiunea cu O-ring			
323 0042	G 3/8"		10/60
323 0016	G 1/2"		10/60
323 0018	G 3/4"		10/60

Cu capac nichelat

**3233EXCEL**

Robinet de retur-coltar, serie EXCEL pentru conectare pe tub de cupru prin sudura

Cod	Dim.	Iesiri	Pret €	Ambalare
323 0038	G 1/2"	Ø 15		10/60
Versiunea cu O-ring				
323 0054	G 1/2"	Ø 15		10/60

**3231EXCEL**

Robinet de retur de colt pentru montare pe tub de cupru/Pex/multistrat

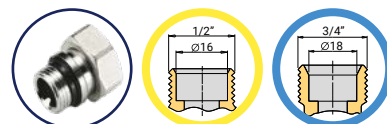

Cod	Dim.	Iesiri	Pret €	Ambalare
323 0004	G 3/8"	1/2" (Ø16)		10/60
323 0002	G 1/2"	1/2" (Ø16)		10/60
323 0053	G 1/2"	3/4" (Ø18)		1/60
Versiunea cu O-ring				
323 0005	G 3/8"	1/2" (Ø16)		10/60
323 0006	G 1/2"	1/2" (Ø16)		10/60

versiune cromata

cu capac cromat

**3231EXPTFE**

Robinet de retur de tur de colt pentru conectare pe tub de cupru/Pex/multistrat. SEMIOLANDEZ CU GARNITURA PTFE

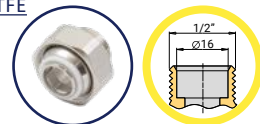

Cod	Dim.	Iesiri	Pret €	Ambalare
323 0057	G 1/2"	1/2" (Ø16)		10/60

Pina la terminarea stocului

12 ROBINETI DE RETUR SERIA "EXCEL"



3230EXCEL
Robinet de retur drept pentru montare pe tub de cupru/Pex/multistrat

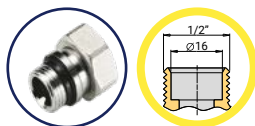

Cod	Dimensiune	Iesiri	Pret €	Ambalare
323 0012	G 3/8"	1/2"(Ø16)		10/60
323 0007	G 1/2"	1/2"(Ø16)		10/60
Versiunea cu O-ring				
323 0015	G 3/8"	1/2"(Ø16)		10/60
323 0019	G 1/2"	1/2"(Ø16)		10/60

12 KIT ROBINETI MANUALI

Robineti manuali tur/retur "EXCEL"



3266KIT01
3266KITR01
Kit compus din: robinet de tur si robinet de retur cu racord pentru tub fier



Cod	Dimensiune	Pret €	Ambalare
326 0074	G 1/2"		60/60
Versiunea cu O-ring			
326 0075	G 1/2"		60/60



3261KIT01
3261KITR01
Kit compus din: robinet de tur si robinet de retur cu racord pentru tub cupru/Pex/multistrat

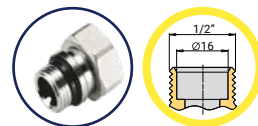

Cod	Dimensiune	Iesiri	Pret €	Ambalare
326 0076	G 1/2"	1/2"(Ø16)		60/60
Versiunea cu O-ring				
326 0077	G 1/2"	1/2"(Ø16)		60/60



3383K

Robinet termostatic „DUAL” cromat pentru instalatii mono/ bitub cu intrare reversibila și sondă metalică de 15 cm. Conexiuni interax 38 mm

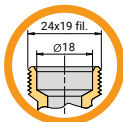

Cod	Dim.	Iesiri	Pret €	Ambalare
338 0002	G 1/2"	24 x 19 fil (Ø18)		1/20

3383K

EXEMPLU DE UTILIZARE

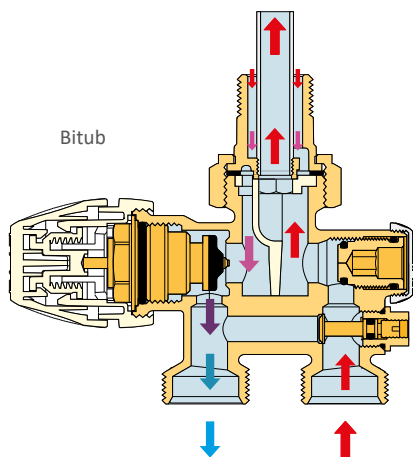
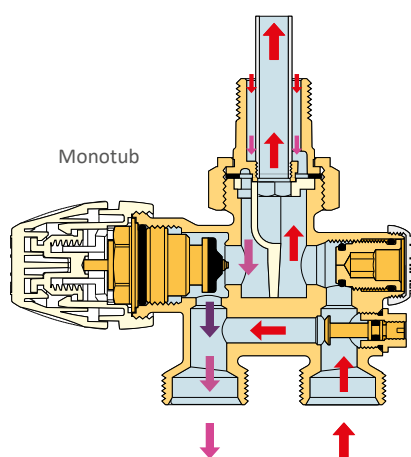

3381KSX

Robinet coltar termostatic „DUAL” cromat pentru instalatii mono/bitub cu intrare reversibila si sonda metalica L=15 cm. Conexiuni interax 38mm

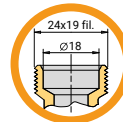

i cu maneta de comanda pe stanga

Cod	Dim.	Iesiri	Pret €	Ambalare
338 0028	G 1/2"	24 x 19 fil (Ø18)		1/20



3381KDX

Robinet coltar termostatic „DUAL” cromat pentru instalatii mono/bitub cu intrare reversibila si sonda metalica L=15 cm. Conexiuni interax 38mm

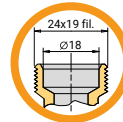

i cu maneta de comanda pe dreapta

Cod	Dim.	Iesiri	Pret €	Ambalare
338 0038	G 1/2"	24 x 19 fil (Ø18)		1/20





3384K

Robinet monotub cromat cu sonda metalica L= 15 cm. Interaxa racorduri 36 mm. Filet cu O-ring

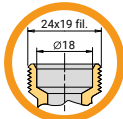

Cod	Dim.	Iesiri	Pret €	Ambalare
338 0015	G 1/2"	24 x 19 fil (ø18)		1/20

3384K

EXEMPLU DE UTILIZARE

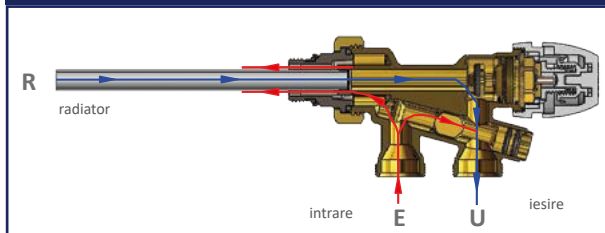

3387K

Robinet monotub compact cromat cu sonda metalica L= 15 cm. Interaxa racorduri 36 mm. Filet cu O-ring

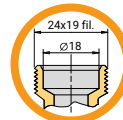

Cod	Dim.	Iesiri	Pret €	Ambalare
338 0034	G 1/2"	24 x 19 fil (ø18)		1/20

3387K

EXEMPLU DE UTILIZARE

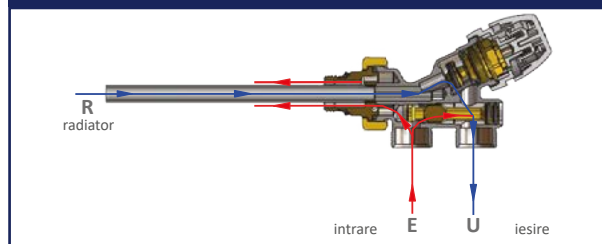

3386K

Robinet bitub cromat cu sonda metalica L= 15 cm. Interaxa racorduri 36 mm. Filet cu O-ring

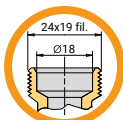

Cod	Dim.	Iesiri	Pret €	Ambalare
338 0022	G 1/2"	24 x 19 fil (ø18)		1/20

3386K

EXEMPLU DE UTILIZARE

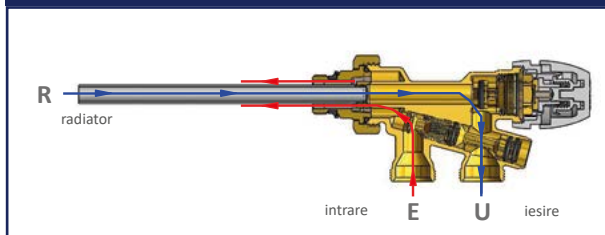

3388K

Robinet bitub compact cromat cu sonda metalica L= 15 cm. Interaxa racorduri 36 mm. Filet cu O-ring

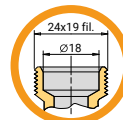

Cod	Dim.	Iesiri	Pret €	Ambalare
338 0035	G 1/2"	24 x 19 fil (ø18)		1/20

3388K

EXEMPLU DE UTILIZARE

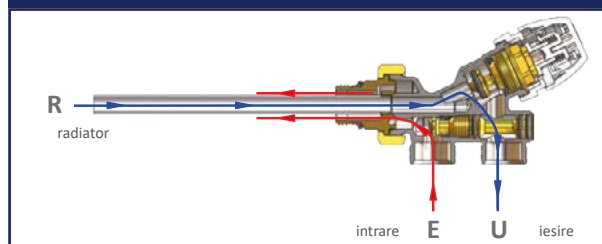



3383SOND

Sonda metalica pentru 3381K, 3383K, 3384K, 3385K si 3386K

Cod	Dimensiune	Pret €	Ambalare
338 0039	Ø10 x 1,0 L = 15 cm		5/50
338 0029	Ø 10 x 1,0 L = 45 cm		5/50



3370K

Distribuitoare cu racorduri de alimentare din pardoseala, cu debit pe calorifer **50%**. Racorduri 24x19 fil (Ø18) cu interaxa 38 mm - racord teava cupru Ø 15 la calorifer

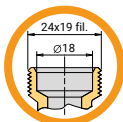

Cod	Dim.	Iesiri	Pret €	Ambalare
337 0003	G 1/2"	24 x 19 fil (Ø18)		5/25



3375K

Distribuitoare cu racorduri de alimentare din pardoseala, cu debit pe calorifer **100%**. Racorduri 24x19 fil (Ø18) cu interaxa 38 mm - racord teava cupru Ø 15 la calorifer

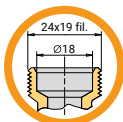

Cod	Dim.	Iesiri	Pret €	Ambalare
337 0002	G 1/2"	24 x 19 fil (Ø18)		5/25



3371K

Distribuitoare cu racorduri de alimentare din perete, cu debit pe calorifer **50%**. Racorduri 24x19 (Ø18) cu interaxa 38 mm - racord teava cupru Ø 15 la calorifer

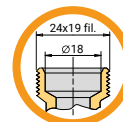

Cod	Dim.	Iesiri	Pret €	Ambalare
337 0005	G 1/2"	24 x 19 fil (Ø18)		5/25



3376K

Distribuitoare cu racorduri de alimentare din perete, cu debit pe calorifer **100%**. Racorduri 24x19 (Ø18) cu interaxa 38 mm - racord teava cupru Ø 15 la calorifer

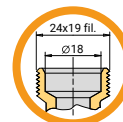

Cod	Dim.	Iesiri	Pret €	Ambalare
337 0006	G 1/2"	24 x 19 fil (Ø18)		5/25



3365N

Cot nichel termostatizabil cu niplu curbat si racord pentru tub de cupru/Pex/multistrat

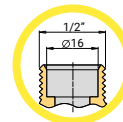

Cod	Dimensiune	Iesiri	Pret €	Ambalare
330 0197	G 1/2"	1/2"(Ø16)		10/60



3391

Distribuitoare bitub pentru calorifere de oțel, cu grup de robineti termostaticizabili încorporat. Alimentare din pardoseala cu racorduri pentru calorifer 3/4"x18 (Eurocono)

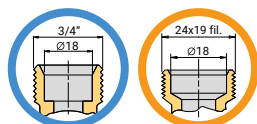

Cod	Dimensiune	Pret €	Ambalare
339 0001	3/4" F - 3/4" (ø18)		15/45
339 0010	3/4" F - 24 x 19 fil (ø18)		15/45

versiune nichelata
versiune cromata



3393

Distribuitoare bitub pentru calorifere de oțel, cu grup de robineti termostaticizabili încorporat. Alimentare din perete cu racorduri pentru calorifer 3/4"x18 (Eurocono)

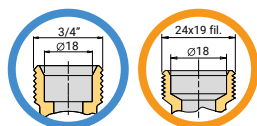

Cod	Dimensiune	Pret €	Ambalare
339 0002	3/4" F - 3/4" (ø18)		10/30
339 0004	3/4" F - 24 x 19 fil (ø18)		10/30

versiune nichelata
versiune cromata

3391 - 3393 EXEMPLU DE UTILIZARE

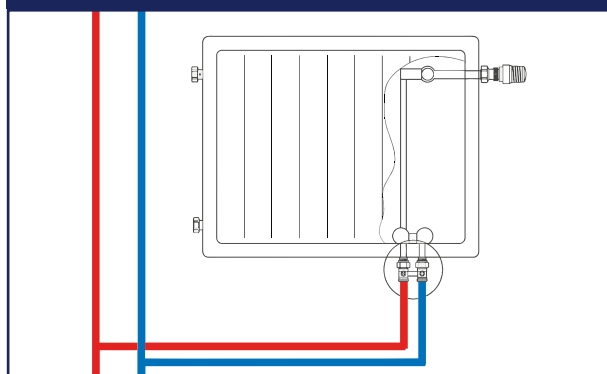

3391BY

Distribuitoare bitub pentru calorifere de oțel, cu grup de robineti termostaticizabili încorporat și by-pass. Alimentare din pardoseala cu racorduri pentru calorifer 3/4"x18 (Eurocono)

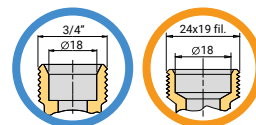

SI BY-PASS

Cod	Dimensiune	Pret €	Ambalare
339 0007	3/4" F - 3/4" (ø18)		10/30
339 0006	3/4" F - 24 x 19 fil (ø18)		10/30

versiune nichelata
versiune cromata



3393BY

Distribuitoare bitub pentru calorifere de oțel, cu grup de robineti termostaticizabili încorporat și by-pass. Alimentare din perete cu racorduri pentru calorifer 3/4"x18 (Eurocono)

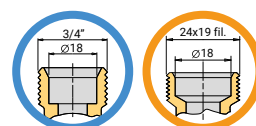

SI BY-PASS

Cod	Dimensiune	Pret €	Ambalare
339 0011	3/4" F - 3/4" (ø18)		10/30
339 0005	3/4" F - 24 x 19 fil (ø18)		10/30

versiune nichelata
versiune cromata



3390RID

Reductie pentru racord 1/2" feminin

Cod	Dimensiune	Pret €	Ambalare
339 0003	3/4" x 1/2"		10/250



3345N

Piulita si inel din lama pentru montarea pe tub din fier G1/2" si pe tub din cupru

Cod	Dimensiune	Pret €	Ambalare
327 0010	10 x 1/2"		10/500
327 0009	12 x 1/2"		10/500
327 0011	14 x 1/2"		10/500
327 0002	15 x 1/2"		10/500
327 0012	16 x 1/2"		10/500

3345N

EXEMPLU DE UTILIZARE

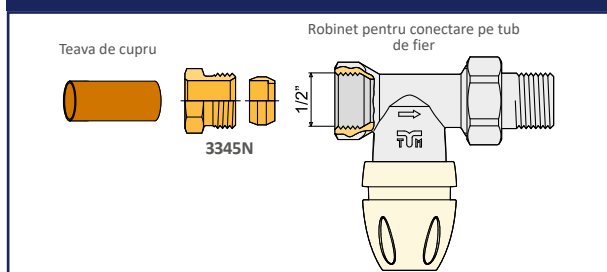

3340C

Rozeta decorativa universala cromat

Cod	Dimensiune	Pret €	Ambalare
327 0075	Ø10 - Ø16		10/100



3342

Rozeta decorativa universala dubla cu interaxa 38 mm

Cod	Dimensiune	Pret €	Ambalare
327 0004	Ø10 - Ø18		1/50



9550

Cap de actionare pentru robinetii seria "3300"

Cod	Dimensiune	Pret €	Ambalare
327 0006	-		5/50



9552P06

Cap manual pentru robinetii seria "MAXIMA"

Cod	Dimensiune	Pret €	Ambalare
327 0038	-		5/50



9552NX

Cap manual pentru robinetii seria "NEW EXCEL"

Cod	Dimensiune	Pret €	Ambalare
327 0054	-		5/50





3338
Racord olandez cu garnitura

Cod	Dimensiune	Pret €	Ambalare
327 0007	3/8"		5/100
327 0003	1/2"		5/100
327 0005	3/4"		5/100



3350
Supapa de aerisire pentru radiatoare

Cod	Dimensiune	Pret €	Ambalare
198 0021	1/8"		10/500
198 0020	1/4"		10/500
198 0015	3/8"		10/500
198 0016	1/2"		10/500



3351
Supapa de aerisire pentru radiatoare, cu garnitura de etansare

Cod	Dimensiune	Pret €	Ambalare
198 0010	1/4"		10/500
198 0008	3/8"		10/500
198 0006	1/2"		10/500



3352
Supapa de aerisire pentru radiatoare

Cod	Dimensiune	Pret €	Ambalare
198 0049	1/4"		10/500
198 0047	3/8"		10/500
198 0018	1/2"		10/500



3300ATTR
Echipament care permite interventia rapida de înlocuire a ventilului încorporat în robinetii termostaziabili chiar si atunci când instalatia este în functiune

Cod	Dimensiune	Pret €	Ambalare
327 0057	-		1/2



H9705
Ventil alamă pentru robinetii termostatzabili

Cod	Dimensiune	Pret €	Ambalare
758 0069	-		10/50



H9706CAP
Capac numerotat 6 pozitii pentru ventil alamă cu pre-reglare

Cod	Dimensiune	Pret €	Ambalare
327 0055	-		10/100



H9706CV
Ventil alamă cu pre-reglare afisată pentru robinetii termostatzabili

Cod	Dimensiune	Pret €	Ambalare
758 0070	-		10/50



9568

Servocomanda electrotermica pentru robinet termostaticabil de inchidere cu indicator de cursa. NORMAL INCHIS (pentru robineti termostaticabili)

Cod	Dimensiune	Pret €	Ambalare
450 0543	24V		1/20
450 0539	230V		1/20
450 0545	24V		1/20
450 0541	230V		1/20

Versiuni cu microinterrupator auxiliar

9568

EXEMPLU DE INSTALARE

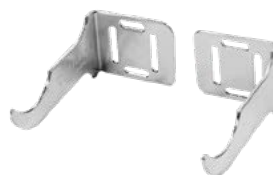

1829Z

Set suporturi de fixare radiator













Cod	Dimensiune	Pret €	Ambalare
076 0002	unica		25/100



13A Sisteme de pardoseli radiante

Introducere		258
Sistem de tip rezidential/tertiar		262
Echipamente		272

13B Colectoare si grupuri de amestec pentru distributie

Set colectoare "Floor" din alama stantata 1"		273
Set colectoare "Floor" din alama stantata 1" 1/4		275
Set colectoare "Floor" din alama stantata cu filet fazat 1"		277
Set colectoare bara din alama - 1"		279
Set colectoare din otel-inox AISI 304L - 1"		281
Accesorii pentru colectoare		284
Adaptoare pentru colectoare		288
Set colectoare "INDUSTRIAL FLOOR" din alama stantata - 1" 1/2		289
Grupuri de amestec - 1"		291
Vana deviatie/amestec		295
Grup de amestec si distributie cu punct fix - 1"		296
Accesorii pentru grupuri de amestec		301



13_A DE CE UN SISTEM DE INCALZIRE PRIN PARDOSEALA TIEMME?

CALDURA ESTE DISTRIBUITA MAI BINE

Radiatoarele se bazeaza pe circulatia aerului prin convecție impingand aerul cald in partea de sus si pe cel rece in partea de jos. In cazul incalzirii prin pardoseala schimbul termic se produce prin radiatie, fenomen care garanteaza o temperatura constanta in ambient.

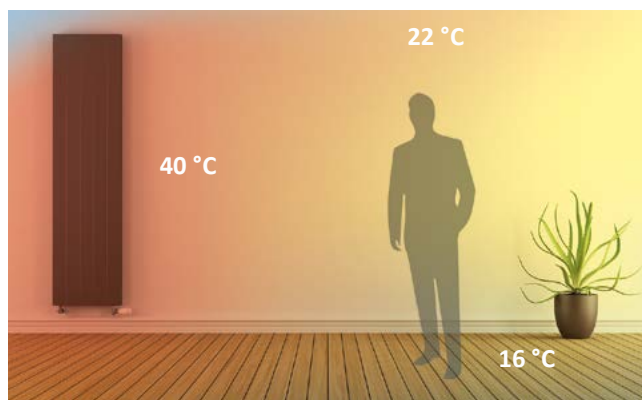

Incalzirea cu radiatoare

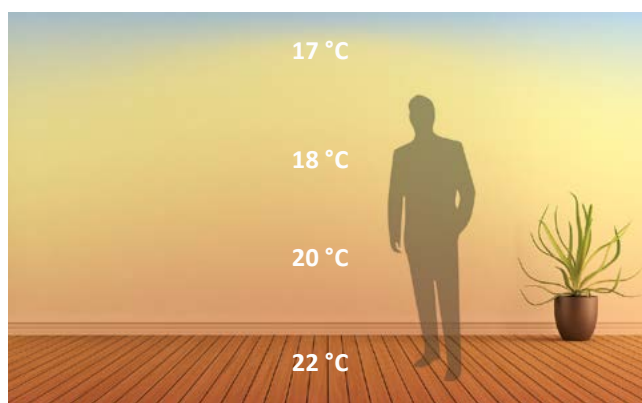

Incalzirea prin pardoseala

COMPATIBILITATE CU ENERGIILE REGENERABILE

Un sistem de incalzire cu radiatoare necesita o centrala cu combustibil gazos sau lichid care poate ridica temperatura apei la o valoare intre 70 si 80°C. Instalatia de incalzire prin pardoseala lucreaza la temperaturi mult inferioare-cuprinse intre 35-40 °C – si din aceste motive ofera o compatibilitate maxima cu sursele de energie mai ecologice pentru mediul inconjurator, precum cazane cu peleti, pompe de caldura si sisteme solare integrate.

REDUCEREA PRAFULUI, ACARIENI SI MUCEGAI

Prezenta radiatoarelor produce praf care apoi se imprastie deranjant in mediul ambient prin efectul de convecție. In cazul incalzirii prin pardoseala aceasta problema se reduce simtitor astfel se reduce si prezenta acarienilor si mucegaiului.

LIBERTATE DEPLINA IN ORGANIZAREA SPATIULUI INTERN

Radiatoarele limiteaza spatiul intern mentinand inutilizabili peretii pe care sunt montate. Instalatia de incalzire prin pardoseala permite castigarea unui spatiu mare lasand peretii in intregime liberi.

LIBERTATE DEPLINA IN ALEGEREA PARDOSELII

Incalzirea radianta este compatibila cu mai multe tipuri de pardoseli: gresie, mocheta. Unica grija priveste lemnul pentru care se va acorda o atentie majora in alegerea unui parchet stabil si de dimensiuni reduse.



Grafitul este una dintre formele alotrope ale carbonului.

Are o structură cristalină cu atomi de carbon dispuși în straturi paralele formând astfel o rețea de hexagoane regulate cu un atom de carbon în vârf. Datorită acestei structuri moleculare speciale de tip fagure, particulele de grafit absorb și reflectă căldura stocată și reduc la minimum transmiterea căldurii prin radiație.

Tocmai pentru a profita de această proprietate, Tiemme a ales să ofere panouri izolante din grafit caracterizate printr-o putere izolatoare mai mare:

- **NEW CLASSIC GRAPHITE**
- **TECHNO GRAPHITE CAM**

Adăugarea de aditivi vă permite să reduceți coeficientul de conductivitate termică până la valoarea de 0,030 W/mk, făcând posibilă respectarea standardului UNI EN 1264 cu o grosime mai mică a stratului izolator al panoului.

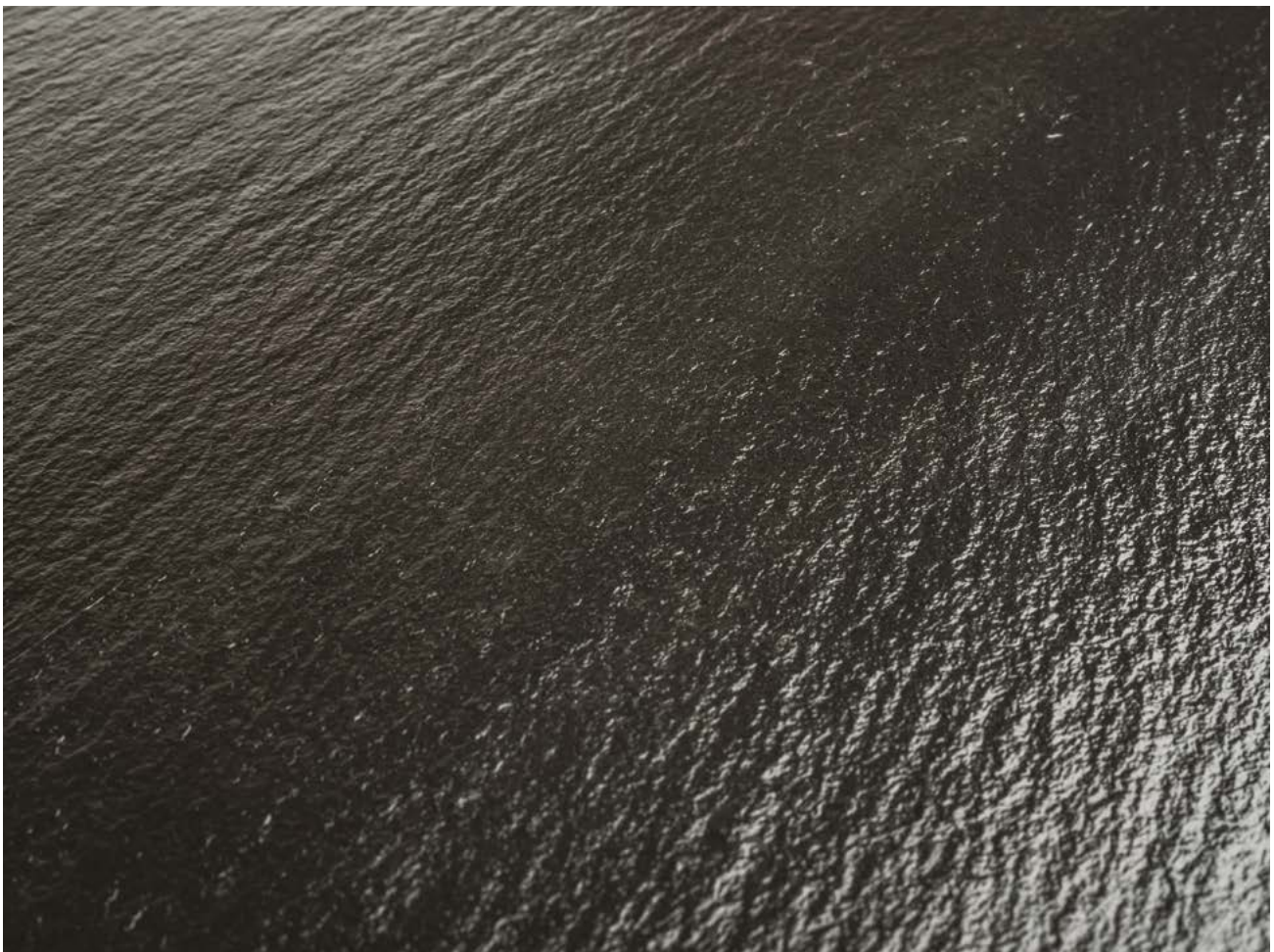

Efesto este software-ul creat de Tiemme și destinat tuturor acelor profesioniști care au nevoie de suport IT care simplifică faza de proiectare a sistemului radiant, fie că este podea, tavan sau perete.

Datorită ușurinței sale de utilizare, vă permite să regăsiți cu ușurință gama Tiemme și să identificați rapid produsele necesare dezvoltării fiecărui proiect.

Iată câteva puncte forte care l-au făcut pe Efesto atât de popular:

- Învățare rapidă pentru faza de proiectare;
- Crearea automată a listelor complete de materiale;
- Abilitatea de a importa și exporta desene în format DWG®;
- Posibilitatea de vizualizare a proiectelor atât în plan cât și pe verticală;
- Funcția de dispunere automată a serpentinelor pentru sisteme de pardoseală radiantă;
- Proiectare sisteme de încălzire și răcire.

Cu Efesto este posibil să se dezvolte orice tip de proiect din gama sistemelor radiante. În special:

- Clădiri de locuit, vile, blocuri sau alte clădiri de uz civil;
- Hale sau alte clădiri de uz industrial;
- Școli, lăcașuri de cult, centre sportive sau alte clădiri de uz public;
- Birouri, puncte de vânzare cu amănuntul sau alte clădiri de uz terțiar.

Efesto este un soft simplu și extrem de versatil, un produs indispensabil pentru cei care vor să facă un pas înainte în ceea ce privește proiectarea.





Sistemele radiante Tiemme oferă o gamă completă de aplicații care vor satisface cel mai bine toate nevoile de confort în orice mediu de locuit.

Fiecare sistem este rezultatul unei dezvoltări continue printre cele mai bune tehnologii și cele mai bune materiale pentru a oferi clienților soluții de ultimă oră atât în ceea ce privește izolația termică și/sau acustică cât și în ceea ce privește eco-durabilitatea.

Dar dacă performanța unui sistem este importantă, la fel de importantă este fiabilitatea acestuia.

Tiemme este foarte conștient de faptul că un sistem radiant nu trebuie să provoace îngrijorări și din acest motiv pune fiabilitatea pe primul loc pe scara sa de valori prin introducerea unei garanții de zece ani pentru sistemele sale. Așa s-a născut Garanta zero10.



GARANȚIE 10 ANI

SISTEME RADIANTE DE ÎNCĂLZIRE/RĂCIRE

Tiemme Raccorderie S.p.A. garantează pentru 10 ani țevile Cobra-pex Oxistop, Al-Cobrapex și accesoriile aferente din alama Tiemme folosite în cadrul instalației radiante. Garanția se acordă prin eliberarea unui certificat numit: **GARANȚIA ZERO10 "Zero Riscuri timp de 10 Ani!"**. Respectivul certificat se eliberează exclusiv în urma unei cereri speciale înaintate de către instalator.

a) Client:

b) Proiectant responsabil: Adresă

c) Proiect de referință: Adresă

d) Locul instalării:

e) Tip de sistem:

f) Tip țevă: CobraPex Oxistop Al-CobraPex

g) Accesorii din alama, oțel, poliamidă:

h) Compania responsabilă cu instalarea: Adresă

i) Distribuitor:

l) Data finalizării instalației:

m) Data testării/pornirii instalației:

Declar pe propria răspundere că materialul a fost instalat și supus testelor, conform instrucțiunilor tehnice publicate în cataloagele tehnice ale producătorului și/sau în standardele de referință și/sau de ștampilă și semnătură instalator:

Data:

Garanția este valabilă numai dacă are toate rubricile completate și dacă este transmisă către TIEMME RACCORDERIE S.p.A. în termen de 30 de zile de la data testării sistemului/pornirii instalației.





G210.BAD.003

1/3

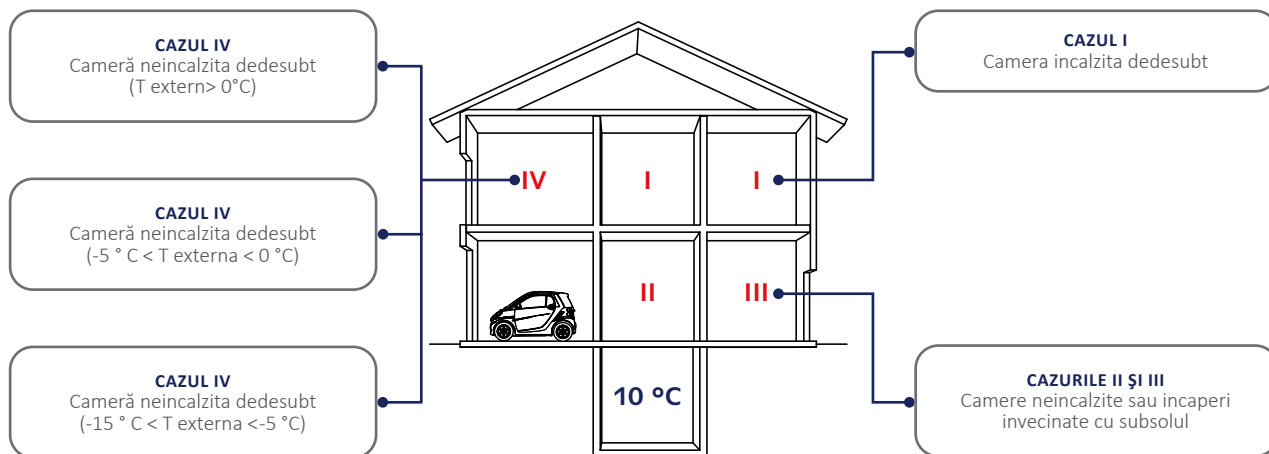

ORIGINAL ITALIAN TRADEMARK

GHID PENTRU ALEGEREA GROSIMILOR CONFORM UNI EN 1264



	R_D ($\text{m}^2\text{K}/\text{W}$)	Grosimea totală echivalentă minimă necesară (mm)	
		EPS cu Grafīt $\lambda_D = 0,030$ (W/mK)	EPS $\lambda_D = 0,035$ (W/mK)
CAZUL I	0,75	22,5	26,5
CAZURILE II și III	1,25	37,5	44
CAZUL IV ($T_{\text{externa}} > 0\text{ }^{\circ}\text{C}$)	1,25	37,5	44
CAZUL IV ($-5\text{ }^{\circ}\text{C} < T_{\text{externa}} < 0\text{ }^{\circ}\text{C}$)	1,50	45	53
CAZUL IV ($-15\text{ }^{\circ}\text{C} < T_{\text{externa}} < -5\text{ }^{\circ}\text{C}$)	2,00	60	70



SOLUȚIILE TIEMME

NEW CLASSIC ȘI NEW CLASSIC GRAPHITE



TECHNO GRAPHITE CAM



BASIC



13A NEW CLASSIC ȘI NEW CLASSIC GRAPHITE

INTRODUCERE

Soluție ideală pentru sistemele de încălzire și răcire rezidențiale și comerciale. Panoul cu nuturi este rezultatul cuplării dintre o placa de polistiren expandat cu aditiv cu grafit (NEW CLASSIC GRAPHITE), obținută cu cele mai bune tehnici de turnare, și o folie de polistiren cu grosimea de 0,16 mm. Rezultatul este un panou ușor de utilizat și disponibil în diferite grosimi de strat izolator, de la 10 la 60 mm, toate certificate și cu o rezistență excelentă la compresiune. Cuplarea între panouri este garantată de un sistem special de cuplare cu îmbinări perimetrice. Pas de instalare 50 mm și multipli.

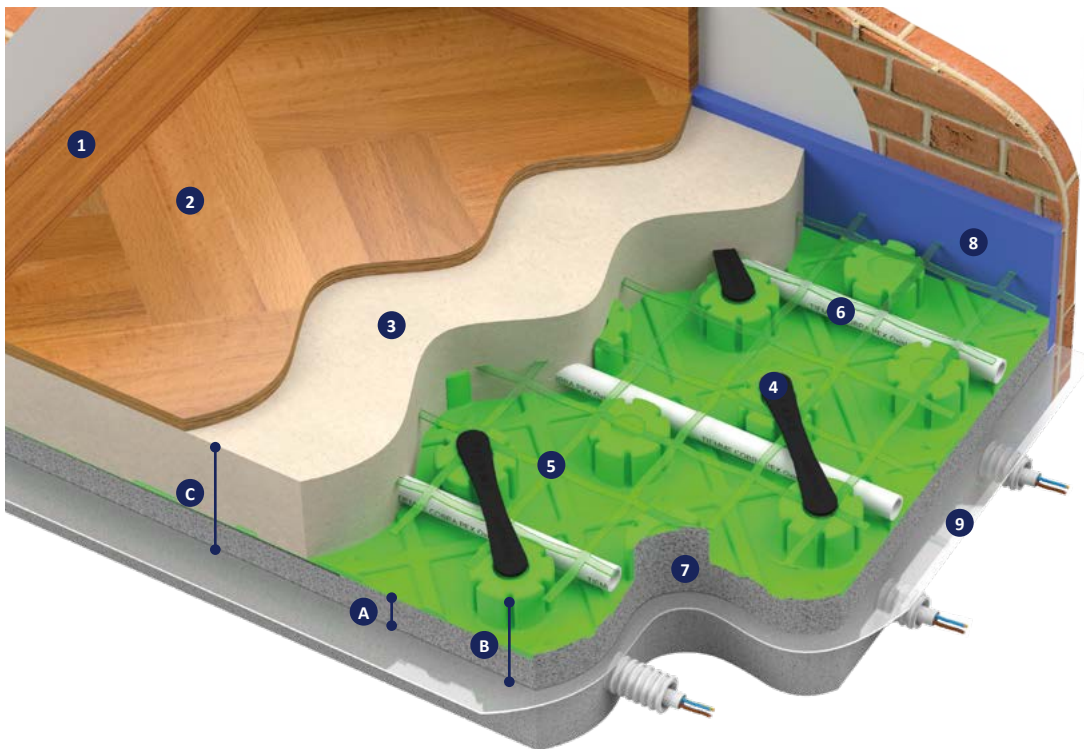

- | | |
|-------------------------------|-------------------|
| 1. Plinta | - |
| 2. Pardoseala | - |
| 3. Sapa speciala | - |
| 4. Colier pentru fixarea tevi | art. 4527 |
| 5. Plasa in fibra de sticla | art. 4532 |
| 6. Tub | art. 0200B |
| 7. Panou izolant | art. 4500/4524GRF |
| 8. Banda perimetrala | art. 4507 |
| 9. Folie PE | art. 4503 |

Cod	Dimensiune (mm)		
	A	B	C
450 0005	20	40	70 ÷ 80
450 0479	10	34	60 ÷ 70
450 0721	23	47	73 ÷ 83
450 0722	38	62	88 ÷ 98
450 0725	45	69	95 ÷ 105
450 0726	60	84	110 ÷ 120

GROSIMI CONFORME CU UNI EN 1264

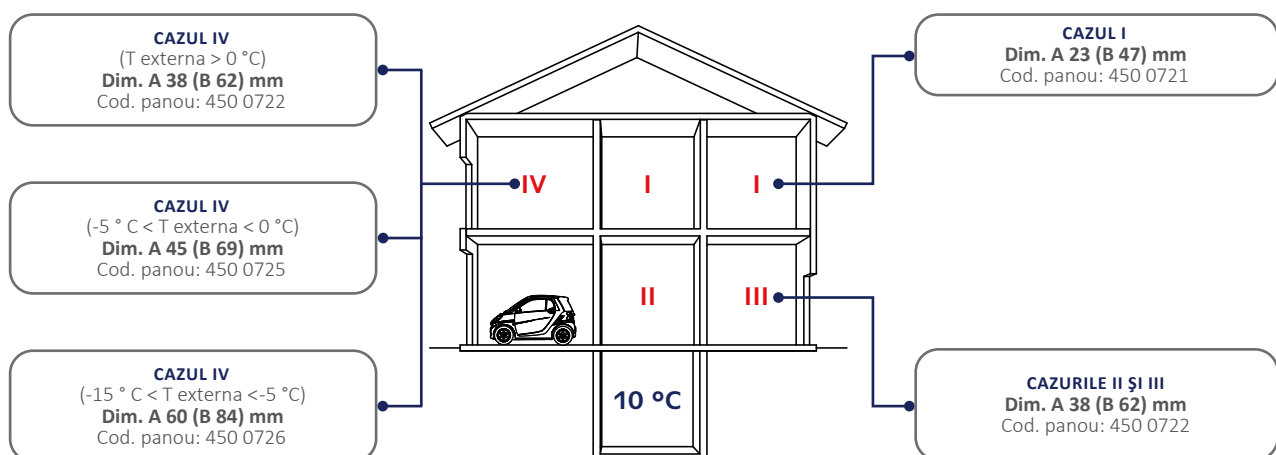

13_A NEW CLASSIC ȘI NEW CLASSIC GRAPHITE

PANOUL IZOLANT

NOUȚĂȚI

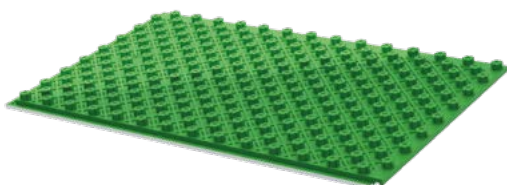

4500

Panoul izolant din polistiren expandat sinterizat respecta normele UNI EN 13163. Nuturile de pe suprafața panoului rezultate în urma termoformării permit montajul tubului la un pas minim de 50mm, iar îmbinarea tip nut și feder asigură o fixare sigură între panouri.

Cod	Grosime izolant (mm)	R.C. 10% (kPa)	Pret €/m ²	Ambalare (m ²)	N° Panouri Pentru ambal.
450 0005	20	200		17,92/71,68	16

NOUȚĂȚI

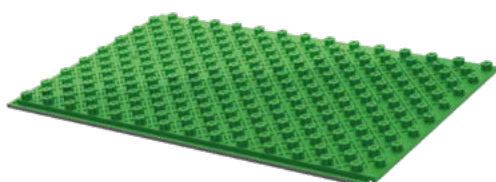

4524GRF

Panoul izolant din polistiren expandat sinterizat cu grafit respecta normele UNI EN 13163. Nuturile de pe suprafața panoului rezultate în urma termoformării permit montajul tubului la un pas minim de 50mm, iar îmbinarea tip nut și feder asigură o fixare sigură între panouri.
Grosimi disponibile conforme prevederilor normelor UNI EN 1264:2021

Cod	Grosime izolant (mm)	R.C. 10% (kPa)	Pret €/m ²	Ambalare (m ²)	N° Panouri Pentru ambal.
450 0479	10	250		21,12/84,48	22
450 0721	23	150		15,68/62,72	14
450 0722	38	150		11,20/44,80	10
450 0725	45	150		8,96/35,84	8
450 0726	60	150		7,84/31,36	7

La cerere

CARACTERISTICI TEHNICE

	Cod					
	450 0005	450 0479	450 0721	450 0722	450 0725	450 0726
Rezistența termică EN 13163 (m ² k/W)	0,61	0,33	0,75	1,25	1,50	2,00
Rezistența la compresie la 10% UNI EN 826 (kPa)	200	250	150			
Grosime izolație (mm)	20	10	23	38	45	60
Grosime totală (mm)	40	34	47	62	69	84
Película de plastic (μm)	160					
Pas minim de așezare (mm)	50					
Conductibilitatea termică UNI EN 12667 (W/mk)	0,033	0,030				
Absorbția apei UNI EN 12087 (%)	<5	7	4			
Reacție la foc EN 13501-1 (Euroclasa)	E					
Dimensiune totală panou (mm)	1425 x 825	1220 x 820	1425 x 825			
Dimensiune utilă panou (mm)	1400 x 800	1220 x 820	1400 x 800			
Suprafața utilă a panoului (m ²)	1,12	0,96	1,12			
Număr panouri în ambalaj (n)	16	22	14	10	8	7
Suprafața panou în ambalaj (m ²)	17,92	21,12	15,68	11,20	8,96	7,84

Soluție ideală pentru sistemele de încălzire și răcire rezidențiale și comerciale. Panoul cu nuturi termoformat permite obținerea chiar și de grosimi mici și, prin urmare, este potrivit și pentru renovări.

Protecție maximă împotriva punților termice. Pas de instalare 50 mm și multipli. Cuplarea dintre panouri este garantată prin suprapunerea nuturilor laterale.

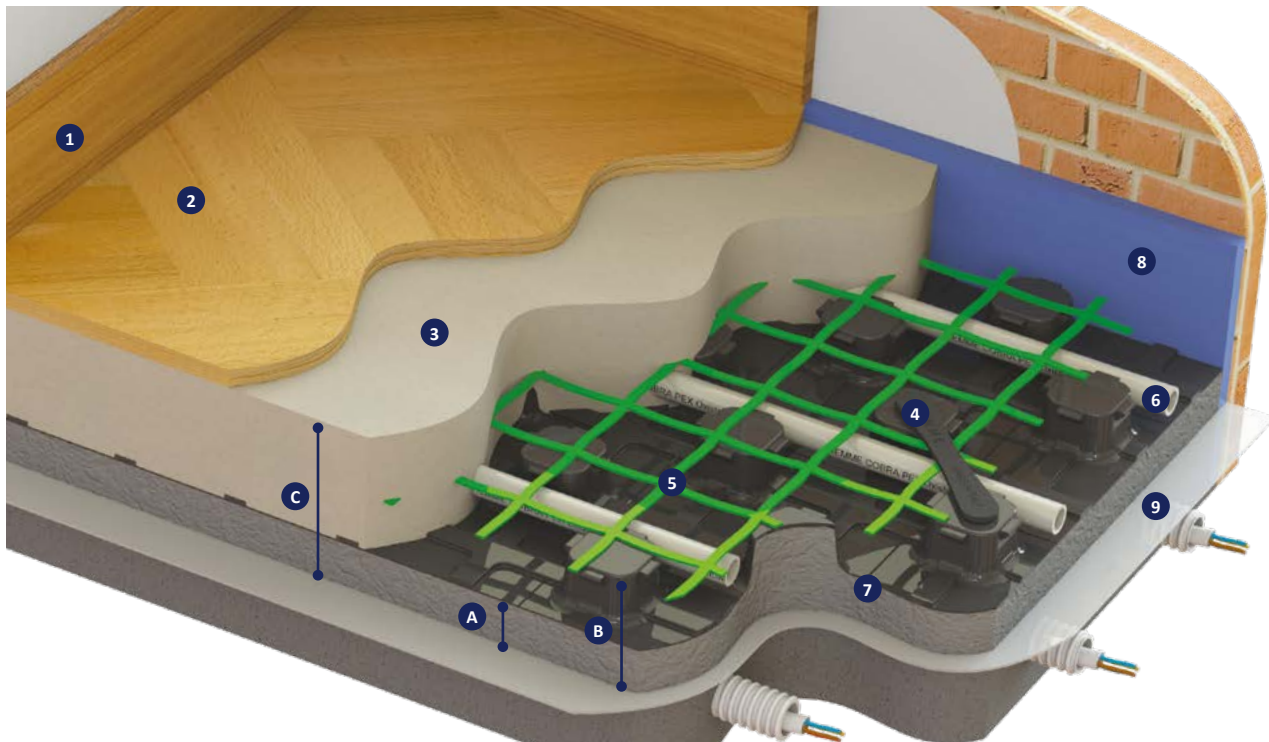

- | | |
|--------------------------------|-----------------|
| 1. Plinta | - |
| 2. Pardoseala | - |
| 3. Sapa speciala | - |
| 4. Colier pentru fixarea tevii | art. 4527 |
| 5. Plasa in fibra de sticla | art. 4532 |
| 6. Tub | art. 0200B |
| 7. Panou izolant | art. 4528PANGRF |
| 8. Banda perimetrala | art. 4507 |
| 9. Folie PE | art. 4503 |

Cod	Dimensiune (mm)		
	A	B	C
450 0729	10	32	60 ÷ 70
450 0730	23	45	73 ÷ 85
450 0731	38	60	88 ÷ 98
450 0732	45	67	95 ÷ 105
450 0733	60	82	110 ÷ 120

GROSIMI CONFORME CU UNI EN 1264

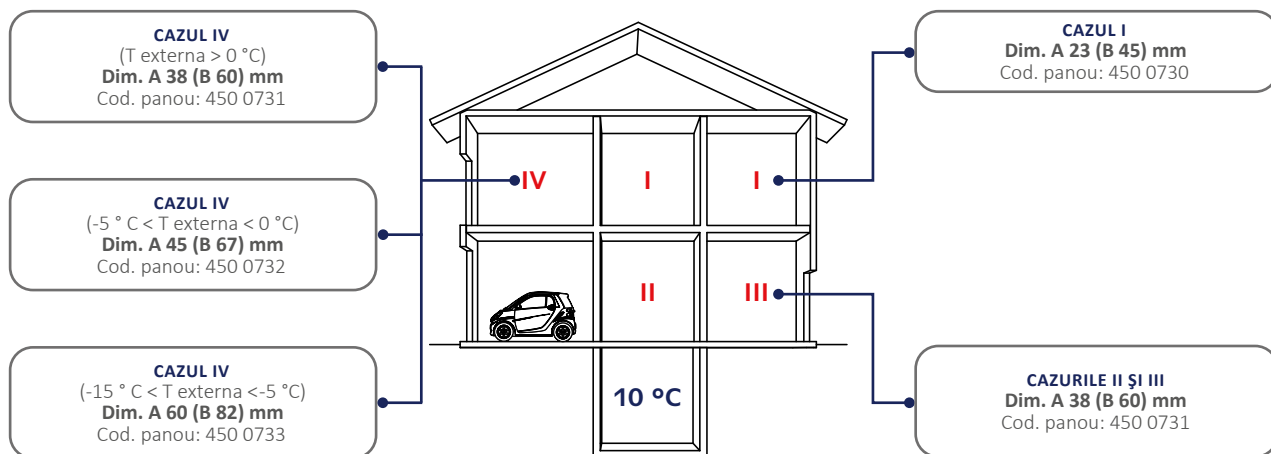

NOUȚĂȚI



4528PANGRF

Placa cu nuturi termoformată din polistiren expandat sinterizat cu grafit și acoperită cu o peliculă de plastic de culoare neagră. Realizat conform normei EN 13163, pelicula de plastic are o structură solidă ce a permis realizarea unor canturi laterale pe corpul nuturilor, obținându-se astfel o fixare mai stabilă a tubului (pas 50mm). Folia rigidă din plastic de culoare neagră îmbunătățește rezistența panoului în timpul montajului. Profilele nuturilor laterale de tip mama-tata asigură o etanșeizare îmbunătățită, fapt ce permite și posibilitatea de utilizare a șapelor auto-nivelante.

Grosimi disponibile conforme prevederilor normelor UNI EN 1264:2021

Cod	Grosime izolant (mm)	R.C. 10% (kPa)	Pret €/m ²	Ambalare (m ²)	N° Panouri Pentru ambal.
450 0729	10	200		20,16/100,8	18
450 0730	23	150		12,32/61,60	11
450 0731	38	150		8,96/44,80	8
450 0732	45	150		7,84/39,20	7
450 0733	60	150		5,60/28,00	5

CARACTERISTICI TEHNICE

	Cod				
	450 0729	450 0730	450 0731	450 0732	450 0733
Rezistența termică EN 13163 (m ² k/W)	0,33	0,75	1,25	1,50	2,00
Rezistența la compresie la 10% UNI EN 826 (kPa)	200	150			
Grosime izolație (mm)	10	23	38	45	60
Grosime totală (mm)	32	45	60	67	82
Placă rigidă de acoperire (mm)	0,6				
Pas minim de așezare (mm)	50				
Conductibilitatea termică UNI EN 12667 (W/mk)	0,030				
Absorbția apei UNI EN 12087 (%)	6,5	4,0			
Reacție la foc EN 13501-1 (Euroclasa)	E				
Dimensiune totală panou (mm)	1450 X 850				
Dimensiune utilă panou (mm)	1400 X 800				
Suprafața utilă a panoului (m ²)	1,12				
Număr panouri în ambalaj (n)	18	11	8	7	5
Suprafața panou în ambalaj (m ²)	20,16	12,32	8,96	7,84	5,60

Soluție ideală pentru sistemele de încălzire și răcire rezidențiale și comerciale. Panoul cu nuturi termoformat permite obținerea chiar și de grosimi mici și, prin urmare, este potrivit și pentru renovări.

Protecție maximă împotriva punctilor termice. Pas de instalare 50 mm și multipli. Cuplarea dintre panouri este garantată prin suprapunerea nuturilor laterale.

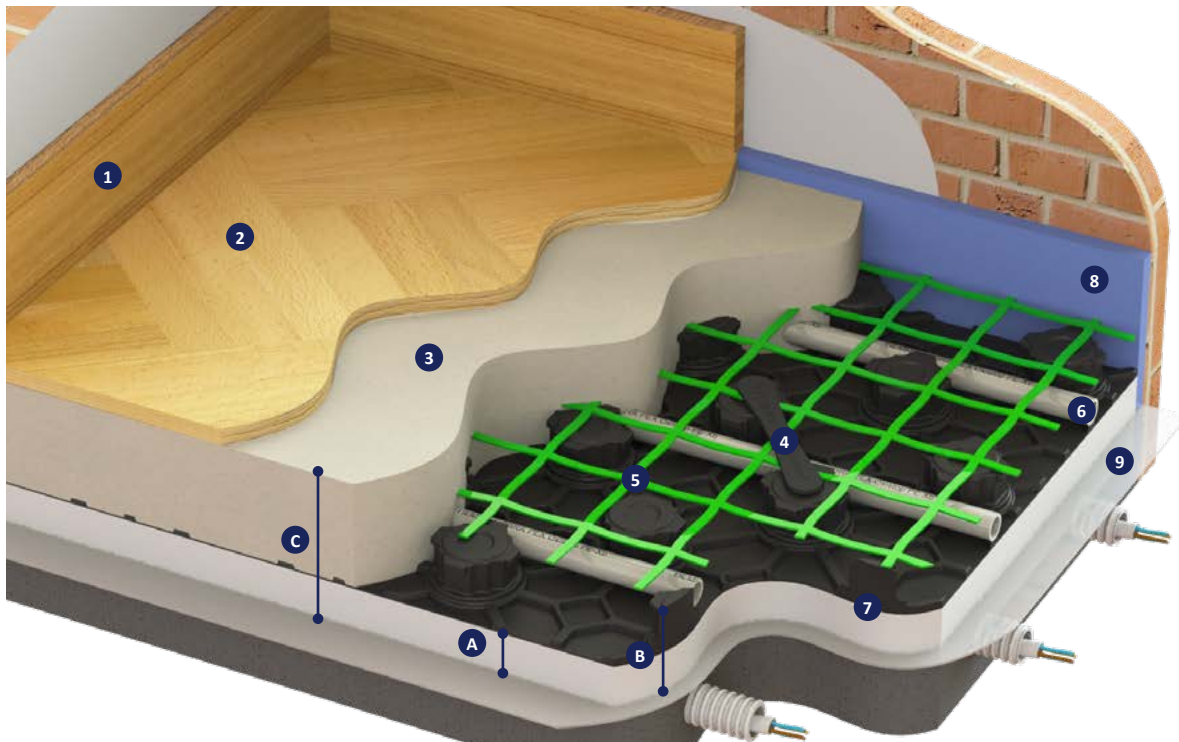

- | | | |
|----|-----------------------------|---------------------|
| 1. | Plinta | - |
| 2. | Pardoseala | - |
| 3. | Sapa speciala | - |
| 4. | Colier pentru fixarea tevii | art. 4527 |
| 5. | Plasa in fibra de sticla | art. 4532 |
| 6. | Tub | art. 0200B |
| 7. | Panou izolant | art. 4501PAN |
| 8. | Banda perimetrala | art. 4507 |
| 9. | Folie PE | art. 4503 |

Cod	Dimensiune (mm)		
	A	B	C
450 0570	10	32	60 ÷ 70
450 0531	20	42	70 ÷ 80
450 0532	30	52	80 ÷ 90
450 0687	40	62	90 ÷ 100

NOUȚĂȚI



4501PAN

Placa cu nuturi termoformată din polistiren expandat sinterizat și acoperită cu o peliculă de plastic de culoare neagră. Realizat conform normei EN 13163, pelicula de plastic are o structură solidă ce a permis realizarea unor canturi laterale pe corpul nuturilor, obținându-se astfel o fixare mai stabilă a tubului (pas 50mm). Folia rigidă din plastic de culoare neagră îmbunătățește rezistența panoului în timpul montajului. Profilele nuturilor laterale de tip mama-tata asigură o etanșare îmbunătățită, fapt ce permite și posibilitatea de utilizare a sașelor auto-nivelante.

Cod	Grosime izolant (mm)	R.C. 10% (kPa)	Pret €/m ²	Ambalare (m ²)	N° Panouri Pentru ambal.
450 0570	10	150		20,16/100,8	18
450 0531	20	150		13,44/67,2	12
450 0532	30	150		11,2/56	10
450 0687	40	150		8,96/44,8	8

CARACTERISTICI TEHNICE

	Cod			
	450 0570	450 0531	450 0532	450 0687
Rezistența termică EN 13163 (m ² k/W)	0,29	0,59	0,88	1,18
Rezistența la compresie la 10% UNI EN 826 (kPa)	150			
Grosime izolație (mm)	10	20	30	40
Grosime totală (mm)	32	42	52	62
Placă rigidă de acoperire (mm)	0,5			
Pas minim de așezare (mm)	50			
Conductibilitatea termică UNI EN 12667 (W/mk)	0,034			
Absorbția apei UNI EN 12087 (%)	0,5			
Reacție la foc EN 13501-1 (Euroclasa)	E			
Dimensiune totală panou (mm)	1450 X 850			
Dimensiune utilă panou (mm)	1400 X 800			
Suprafața utilă a panoului (m ²)	1,12			
Număr panouri în ambalaj (n)	18	12	10	8
Suprafața panou în ambalaj (m ²)	20,16	13,44	11,20	8,96



0200B

Tub din polietilena reticulata de inalta densitate **COBRAPEX** cu bariera oxigen (EVOH). Culoare alba

CARACTERISTICI TEHNICE

- Temperatura maxima de lucru: 95°C
- Conductivitate termică: 0,38 W/mk
- Conform EN ISO 15875-2
- Bariera de oxigen EVOH conformă cu DIN 4726
- Compozitie: PE-Xb

Cod	Dimensiune	Pret €/m	Ambalare (m)
020 0005	16 x 2,0		120/3240
020 0018	16 x 2,0		200/3600
020 0003	16 x 2,0		300/3600
020 0001	16 x 2,0		600/3000
020 0008	17 x 2,0		120/3240
020 0071	17 x 2,0		200/3200
020 0006	17 x 2,0		300/2700
020 0002	17 x 2,0		600/3000



0200R

Tub din polietilena reticulata de inalta densitate **COBRAPEX** cu bariera oxigen (EVOH). Culoare rosie

i De culoare tub ■

Cod	Dimensiune	Pret €/m	Ambalare (m)
020 0074	16 x 2,0		300/3600
020 0090	16 x 2,0		600/3000
020 0128	17 x 2,0		600/3000

NOU TATI



0210R

Tub din polietilena rezistenta la temperaturi ridicate **COBRAPERT** cu bariera oxigen (EVOH). Culoare rosie.

CARACTERISTICI TEHNICE

- Temperatura maxima de lucru: 70°C
- Conductivitate termică: 0,40 W/mk
- Conform EN ISO 22391
- Bariera de oxigen EVOH conformă cu DIN 4726
- Compozitie: PE-RT

i De culoare tub ■

Cod	Dimensiune	Pret €/m	Ambalare (m)
021 0004	16 x 2,0		300/2700
021 0003	16 x 2,0		600/3000
021 0005	17 x 2,0		600/3000



4507

Banda perimetrata din PE expandat cu partea posterioara complet adeziva si folie din PE.

i Pretaiata H=100mm

Cod	Dimensiune	Pret €/m	Ambalare (m)
450 0443	H 150 x 5 mm		50/250
450 0007	H 150 x 8 mm		25/125



1480P

Curba conductoare la 90° din plastic pentru protectia si sustinerea tubului „COBRAPEX” in apropierea racordului la colectorul de distributie

Cod	Dimensiune	Pret €	Ambalare
034 0077	tub Ø 16 - 18		25/500



4527

Colier de fixare pe panou a tubului si/sau plasei zincate de prindere. Realizat din plastic si prevazut cu aripiore de fixare

Cod	Dimensiune (mm)	Pret €	Ambalare
450 0018	H = 28		100/1000



4540

Aditiv pentru sapa în solutie apoasa compus din polimeri acrilici; reduce contractiile higroscopice reducand rezistenta termica si îmbunatatind conductivitatea.

CARACTERISTICI TEHNICE

- Dozaj: 1kg aditiv x 100 kg ciment

Cod	Dimensiune	Pret €/kg	Ambalare (kg)
450 0019	10 Kg ≈ 9,6 l		10/10
450 0017	25 Kg ≈ 24 l		25/25



LISTA DE PREȚURI



4508

Profil de dilatare din PE cu suport autoadeziv.

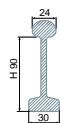

CARACTERISTICI TEHNICE

- Inaltime: 90 mm
- Lungime: 2m

Cod	Dimensiune	Pret €/m	Ambalare (m)
450 0023	-		20/180



4503

Folie PE cu rol de izolatie si bariera impotriva umiditatii.

CARACTERISTICI TEHNICE

- Latime: 1,2 m
- Lungime: 100 m
- Grosime: 0,15 mm

Cod	Dimensiune	Pret €/m ²	Ambalare (m ²)
450 0025	-		120/120

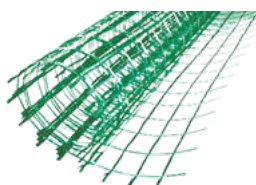

4532

Plasa din fibra de sticla tratata antialkalin pentru armarea sapelor de ciment.

CARACTERISTICI TEHNICE

- Dimensiunea ochiului: 40 x 40 mm
- Greutate: 130 g/m²

i La cerere și plasă de sârmă de 2 mm.

Cod	Dimensiune	Pret €/m ²	Ambalare (m ²)
450 0152	1 m x 50 m		50/400
450 0022	1 m x 100 m		100/400



4539

Solutie protectiva contra coroziei, in particular metalice cu Fungicid antibacterian universal pentru sisteme de incalzire si racire

CARACTERISTICI TEHNICE

- Dozare: 1 l aditiv x 100 l apa

Cod	Dimensiune	Pret €	Ambalare
450 0486	1 l		1/12



4535

Pompa de incercare a instalatiilor la presiune, cu racord de 1/2\".

i Capacitate rezervor 8 l

Cod	Dimensiune	Pret €	Ambalare
450 0049	50 bar		1



4530

Dispozitiv de desfasurat tubul (pana la 20)

Cod	Dimensiune	Pret €	Ambalare
450 0028	-		1



1495

Foarfecă pentru tuburi

Cod	Dimensiune	Pret €	Ambalare
034 0015	∅ 0 - 35		50/200



4522

Masina de uscat sapa

Cod	Dimensiune	Pret €	Ambalare
450 0020	230 Vac 2,5 KW		1/1



4522A

Adaptor 380VAC-230VAC pentru masina de uscat sapa

Cod	Dimensiune	Pret €	Ambalare
450 0381	230 - 380 Vac		1/5



13_B SET COLECTOARE "FLOOR" DIN ALAMA STANTATA 1"

Pentru utilizare cu caseta 1939 (pag. 287)



3873J

Colector de distribuție de 1" cu debitmetre

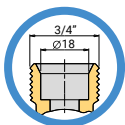

Cod	Dimensiune	Cai	Pret €	Ambalare
385 0106	1"G	2		1/1
385 0107	1"G	3		1/1
385 0108	1"G	4		1/1
385 0109	1"G	5		1/1
385 0110	1"G	6		1/1
385 0111	1"G	7		1/1
385 0112	1"G	8		1/1
385 0113	1"G	9		1/1
385 0114	1"G	10		1/1
385 0115	1"G	11		1/1
385 0116	1"G	12		1/1



3878

Colector de distribuție de 1" cu memorie mecanică

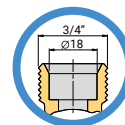

Cod	Dimensiune	Cai	Pret €	Ambalare
385 0040	1"G	2		1/1
385 0042	1"G	3		1/1
385 0035	1"G	4		1/1
385 0030	1"G	5		1/1
385 0028	1"G	6		1/1
385 0044	1"G	7		1/1
385 0031	1"G	8		1/1
385 0065	1"G	9		1/1
385 0058	1"G	10		1/1
385 0057	1"G	11		1/1
385 0060	1"G	12		1/1



3873BYD

Colector de distribuție de 1" cu by-pass diferential și debitmetre



Cu by-pass diferential

Cod	Dimensiune	Cai	Pret €	Ambalare
385 0062	1"G	2		1/1
385 0061	1"G	3		1/1
385 0043	1"G	4		1/1
385 0026	1"G	5		1/1
385 0001	1"G	6		1/1
385 0004	1"G	7		1/1
385 0008	1"G	8		1/1
385 0013	1"G	9		1/1
385 0006	1"G	10		1/1
385 0021	1"G	11		1/1
385 0007	1"G	12		1/1
385 0120	1"G	13		1/1
385 0121	1"G	14		1/1



3878BYD

Colector de distribuție de 1" cu by-pass diferential și memorie mecanică



Cu by-pass diferential

Cod	Dimensiune	Cai	Pret €	Ambalare
385 0068	1"G	2		1/1
385 0069	1"G	3		1/1
385 0067	1"G	4		1/1
385 0064	1"G	5		1/1
385 0052	1"G	6		1/1
385 0066	1"G	7		1/1
385 0033	1"G	8		1/1
385 0055	1"G	9		1/1
385 0051	1"G	10		1/1
385 0050	1"G	11		1/1
385 0056	1"G	12		1/1

13_B SET COLECTOARE "FLOOR" DIN ALAMA STANTATA 1"

Pentru utilizare cu caseta 1940 (pag. 287)



3873RJ

Colector de distribuție de 1" cu debitmetre și izolație

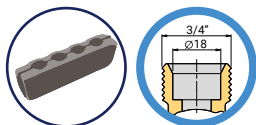

Cod	Dimensiune	Cai	Pret €	Ambalare
557 0546	1"G	2		1/1
557 0547	1"G	3		1/1
557 0548	1"G	4		1/1
557 0549	1"G	5		1/1
557 0550	1"G	6		1/1
557 0551	1"G	7		1/1
557 0552	1"G	8		1/1
557 0553	1"G	9		1/1
557 0554	1"G	10		1/1
557 0555	1"G	11		1/1
557 0556	1"G	12		1/1



3878R

Colector de distribuție de 1" cu memorie mecanică și izolație

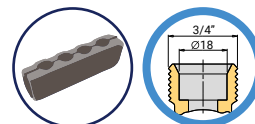

Cod	Dimensiune	Cai	Pret €	Ambalare
557 0051	1"G	2		1/1
557 0052	1"G	3		1/1
557 0053	1"G	4		1/1
557 0054	1"G	5		1/1
557 0055	1"G	6		1/1
557 0056	1"G	7		1/1
557 0057	1"G	8		1/1
557 0058	1"G	9		1/1
557 0059	1"G	10		1/1
557 0060	1"G	11		1/1
557 0061	1"G	12		1/1



3873RBYDJ

Colector de distribuție de 1" cu by-pass diferential debitmetre și izolație



Cu by-pass diferential

Cod	Dimensiune	Cai	Pret €	Ambalare
557 0653	1"G	2		1/1
557 0654	1"G	3		1/1
557 0655	1"G	4		1/1
557 0656	1"G	5		1/1
557 0657	1"G	6		1/1
557 0658	1"G	7		1/1
557 0659	1"G	8		1/1
557 0660	1"G	9		1/1
557 0661	1"G	10		1/1
557 0662	1"G	11		1/1
557 0663	1"G	12		1/1
557 0670	1"G	13		1/1
557 0671	1"G	14		1/1



3878RBYD

Colector de distribuție de 1" cu by-pass diferential memorie mecanică și izolație



Cu by-pass diferential

Cod	Dimensiune	Cai	Pret €	Ambalare
557 0062	1"G	2		1/1
557 0063	1"G	3		1/1
557 0064	1"G	4		1/1
557 0065	1"G	5		1/1
557 0066	1"G	6		1/1
557 0067	1"G	7		1/1
557 0068	1"G	8		1/1
557 0069	1"G	9		1/1
557 0070	1"G	10		1/1
557 0071	1"G	11		1/1
557 0072	1"G	12		1/1



13_B SET COLECTOARE "FLOOR" DIN ALAMA STANTATA 1" 1/4

Pentru utilizare cu caseta 1940 (pag. 287)



3877

Colector de distribuție de 1" 1/4 cu debitmetre

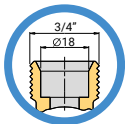

Cod	Dimensiune	Cai	Pret €	Ambalare
385 0122	1" 1/4G	2		1/1
385 0123	1" 1/4G	3		1/1
385 0124	1" 1/4G	4		1/1
385 0125	1" 1/4G	5		1/1
385 0126	1" 1/4G	6		1/1
385 0127	1" 1/4G	7		1/1
385 0128	1" 1/4G	8		1/1
385 0129	1" 1/4G	9		1/1
385 0130	1" 1/4G	10		1/1
385 0131	1" 1/4G	11		1/1
385 0132	1" 1/4G	12		1/1



3879

Colector de distribuție de 1" 1/4 cu memorie mecanică

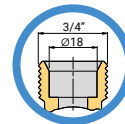

Cod	Dimensiune	Cai	Pret €	Ambalare
385 0144	1" 1/4G	2		1/1
385 0145	1" 1/4G	3		1/1
385 0146	1" 1/4G	4		1/1
385 0147	1" 1/4G	5		1/1
385 0148	1" 1/4G	6		1/1
385 0149	1" 1/4G	7		1/1
385 0150	1" 1/4G	8		1/1
385 0151	1" 1/4G	9		1/1
385 0152	1" 1/4G	10		1/1
385 0153	1" 1/4G	11		1/1
385 0154	1" 1/4G	12		1/1



3877BYD

Colector de distribuție de 1" 1/4 cu by-pass diferential și debitmetre



Cu by-pass diferential

Cod	Dimensiune	Cai	Pret €	Ambalare
385 0133	1" 1/4G	2		1/1
385 0134	1" 1/4G	3		1/1
385 0135	1" 1/4G	4		1/1
385 0136	1" 1/4G	5		1/1
385 0137	1" 1/4G	6		1/1
385 0138	1" 1/4G	7		1/1
385 0139	1" 1/4G	8		1/1
385 0140	1" 1/4G	9		1/1
385 0141	1" 1/4G	10		1/1
385 0142	1" 1/4G	11		1/1
385 0143	1" 1/4G	12		1/1



3879BYD

Colector de distribuție de 1" 1/4 cu by-pass diferential și memorie mecanică



Cu by-pass diferential

Cod	Dimensiune	Cai	Pret €	Ambalare
385 0155	1" 1/4G	2		1/1
385 0156	1" 1/4G	3		1/1
385 0157	1" 1/4G	4		1/1
385 0158	1" 1/4G	5		1/1
385 0159	1" 1/4G	6		1/1
385 0160	1" 1/4G	7		1/1
385 0161	1" 1/4G	8		1/1
385 0162	1" 1/4G	9		1/1
385 0163	1" 1/4G	10		1/1
385 0164	1" 1/4G	11		1/1
385 0165	1" 1/4G	12		1/1

13_B SET COLECTOARE "FLOOR" DIN ALAMA STANTATA 1" 1/4

Pentru utilizare cu caseta 1940 (pag. 287)

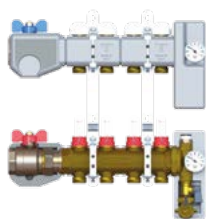

3877R

Colector de distribuție izolat 1" 1/4 cu debitmetre

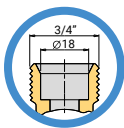

Cod	Dimensiune	Cai	Pret €	Ambalare
557 0571	1" 1/4G	2		1/1
557 0572	1" 1/4G	3		1/1
557 0573	1" 1/4G	4		1/1
557 0574	1" 1/4G	5		1/1
557 0575	1" 1/4G	6		1/1
557 0576	1" 1/4G	7		1/1
557 0577	1" 1/4G	8		1/1
557 0578	1" 1/4G	9		1/1
557 0579	1" 1/4G	10		1/1
557 0580	1" 1/4G	11		1/1
557 0581	1" 1/4G	12		1/1

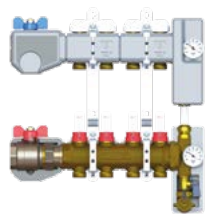

3877RBYD

Colector de distribuție izolat de 1" 1/4 cu by-pass diferential și debitmetre

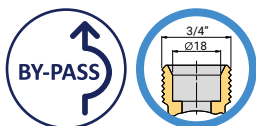

Cu by-pass diferential

Cod	Dimensiune	Cai	Pret €	Ambalare
557 0582	1" 1/4G	2		1/1
557 0583	1" 1/4G	3		1/1
557 0584	1" 1/4G	4		1/1
557 0585	1" 1/4G	5		1/1
557 0586	1" 1/4G	6		1/1
557 0587	1" 1/4G	7		1/1
557 0588	1" 1/4G	8		1/1
557 0589	1" 1/4G	9		1/1
557 0590	1" 1/4G	10		1/1
557 0591	1" 1/4G	11		1/1
557 0592	1" 1/4G	12		1/1

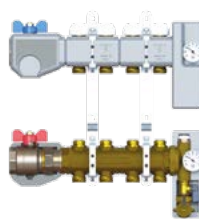

3879R

Colector de distribuție izolat de 1" 1/4 cu memorie mecanică

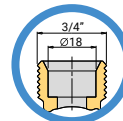

Cod	Dimensiune	Cai	Pret €	Ambalare
557 0561	1" 1/4G	2		1/1
557 0562	1" 1/4G	3		1/1
557 0563	1" 1/4G	4		1/1
557 0564	1" 1/4G	5		1/1
557 0565	1" 1/4G	6		1/1

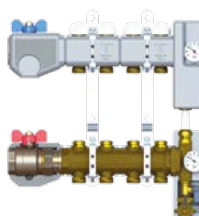

3879RBYD

Colector de distribuție izolat de 1" 1/4 cu by-pass diferential și memorie mecanică



Cu by-pass diferential

Cod	Dimensiune	Cai	Pret €	Ambalare
557 0566	1" 1/4G	2		1/1
557 0567	1" 1/4G	3		1/1
557 0568	1" 1/4G	4		1/1
557 0569	1" 1/4G	5		1/1
557 0570	1" 1/4G	6		1/1



13_B SET COLECTOARE "FLOOR" DIN ALAMA STANTATA CU FILET FAZAT 1"

Pentru utilizare cu caseta 1939 (pag. 287)



3049

Colector de distributie cu filet fazat de 1" cu iesiri 3/4"x18 (Eurocono) si indicatoare de debit

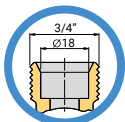

Cod	Dimensiune	Cai	Pret €	Ambalare
385 0047	1"G	2		1/1
385 0039	1"G	3		1/1
385 0032	1"G	4		1/1
385 0016	1"G	5		1/1
385 0003	1"G	6		1/1
385 0012	1"G	7		1/1
385 0019	1"G	8		1/1
385 0025	1"G	9		1/1
385 0037	1"G	10		1/1
385 0053	1"G	11		1/1
385 0046	1"G	12		1/1
385 0070	1"G	13		1/1
385 0071	1"G	14		1/1



3050

Colector de distributie cu filet fazat de 1" cu iesiri 3/4"x18 (Eurocono) si vane cu memorie mecanica

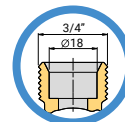

Cod	Dimensiune	Cai	Pret €	Ambalare
385 0059	1"G	2		1/1
385 0054	1"G	3		1/1
385 0034	1"G	4		1/1
385 0038	1"G	5		1/1
385 0017	1"G	6		1/1
385 0018	1"G	7		1/1
385 0023	1"G	8		1/1
385 0024	1"G	9		1/1
385 0027	1"G	10		1/1
385 0048	1"G	11		1/1
385 0049	1"G	12		1/1
385 0072	1"G	13		1/1
385 0073	1"G	14		1/1



3049I

Colector de distributie cu filet fazat de 1" cu iesiri 3/4"x18 (Eurocono) si indicatoare de debit

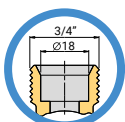

i Debitmetre instalate pe partea superioară a kitului

Cod	Dimensiune	Cai	Pret €	Ambalare
385 0084	1"G	2		1/1
385 0085	1"G	3		1/1
385 0086	1"G	4		1/1
385 0087	1"G	5		1/1
385 0088	1"G	6		1/1
385 0089	1"G	7		1/1
385 0090	1"G	8		1/1
385 0091	1"G	9		1/1
385 0092	1"G	10		1/1
385 0093	1"G	11		1/1
385 0094	1"G	12		1/1



3050I

Colector de distributie cu filet fazat de 1" cu iesiri 3/4"x18 (Eurocono) si vane cu memorie mecanica

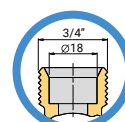

i Ventilele cu memorie mecanica instalate pe partea superioară a kitului

Cod	Dimensiune	Cai	Pret €	Ambalare
385 0095	1"G	2		1/1
385 0096	1"G	3		1/1
385 0097	1"G	4		1/1
385 0098	1"G	5		1/1
385 0099	1"G	6		1/1
385 0100	1"G	7		1/1
385 0101	1"G	8		1/1
385 0102	1"G	9		1/1
385 0103	1"G	10		1/1
385 0104	1"G	11		1/1
385 0105	1"G	12		1/1



3049KIT01
Kit terminal pentru colectoare
"FLOOR"

Cod	Dimensiune	Pret €	Ambalare
385 0005	1"		1/5
385 0266	1"1/4		1/5



3049KIT01J
Kit terminal pentru colectoare
"FLOOR"

Cod	Dimensiune	Pret €	Ambalare
385 0117	1"		1/5
385 0281	1"1/4		1/5

NOU TATI!



3049KIT02D
Kit terminal cu by-pass
diferential pentru colectoare
"FLOOR"

Cu by-pass diferential

Cod	Dimensiune	Pret €	Ambalare
385 0285	1"		1/8
385 0286	1"1/4		1/5



3049KIT02JD
Kit terminal cu by-pass
diferential pentru colectoare
"FLOOR"

Cu by-pass diferential

Cod	Dimensiune	Pret €	Ambalare
385 0282	1"		1/8

EXEMPLU DE INSTALARE

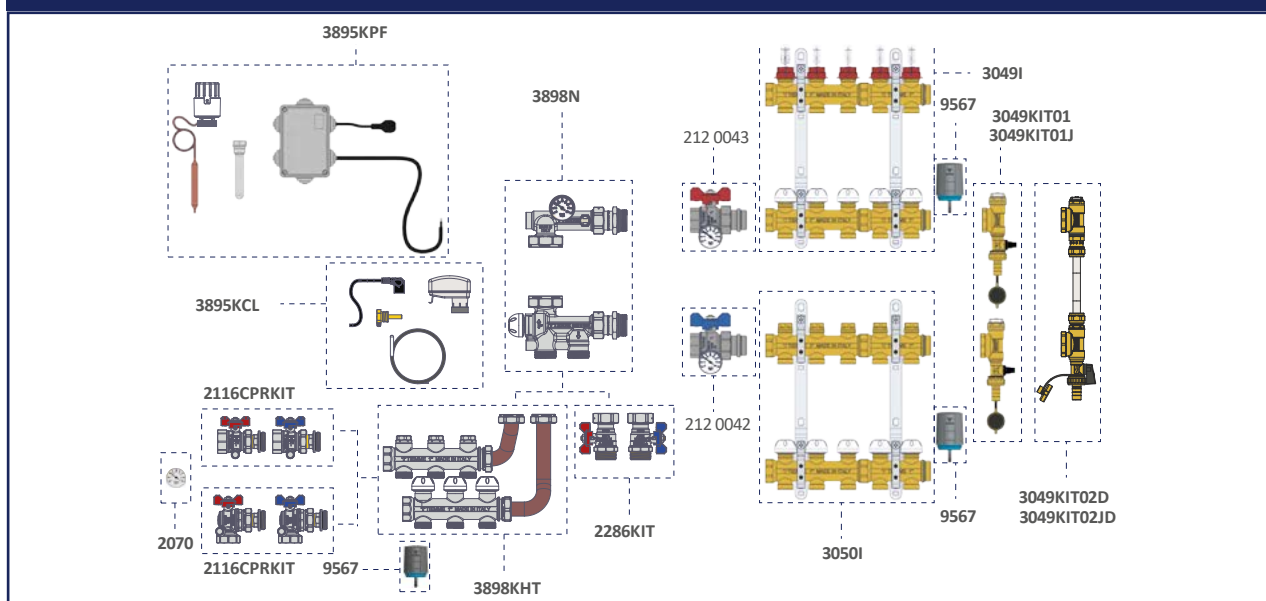

13_B SET COLECTOARE BARA DIN ALAMA - 1"

Pentru utilizare cu caseta 1939 (pag. 287)

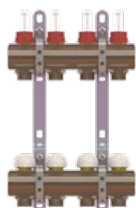

3856N

Colector de distribuție de 1" cu debitmetre

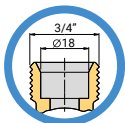

Cod	Dimensiune	Cai	Pret €	Ambalare
387 0309	1"G	3		1/1
387 0202	1"G	4		1/1
387 0311	1"G	5		1/1
387 0307	1"G	6		1/1
387 0312	1"G	7		1/1
387 0308	1"G	8		1/1
387 0313	1"G	9		1/1
387 0314	1"G	10		1/1
387 0315	1"G	11		1/1
387 0310	1"G	12		1/1



3866N

Colector de distribuție de 1" cu memorie mecanică

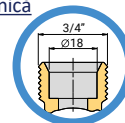

Cod	Dimensiune	Cai	Pret €	Ambalare
387 0271	1"G	3		1/1
387 0303	1"G	4		1/1
387 0263	1"G	5		1/1
387 0264	1"G	6		1/1
387 0265	1"G	7		1/1
387 0266	1"G	8		1/1
387 0267	1"G	9		1/1
387 0268	1"G	10		1/1
387 0269	1"G	11		1/1
387 0270	1"G	12		1/1

13_B SET COLECTOARE BARA DIN ALAMA - 1"



3891N
Kit terminal pentru colectoare
3856X - 3866X - 3856N - 3866N

Cod	Dimensiune	Pret €	Ambalare
450 0441	1"		1/10



3891NBY
Kit terminal cu by-pass pentru
colectoare 3856X - 3866X -
3856N - 3866N

Cod	Dimensiune	Pret €	Ambalare
450 0442	1"		1/10



3891NJ
Kit terminal pentru colectoare

Cod	Dimensiune	Pret €	Ambalare
450 0484	1"		1/5



3891NBYJ
Kit terminal cu by-pass pentru
colectoare

Cod	Dimensiune	Pret €	Ambalare
450 0485	1"		1/8

GHID DE ACCESORII

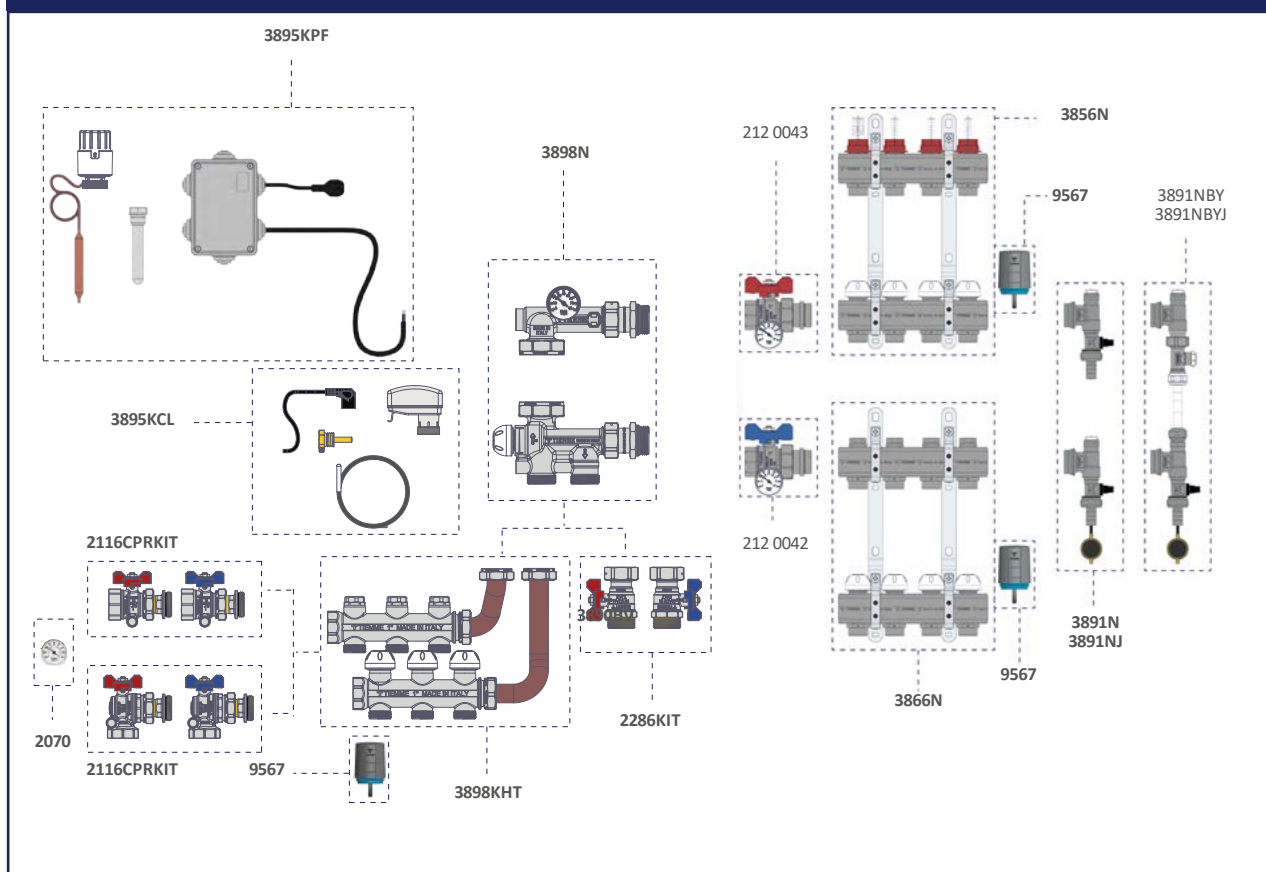

13_B SET COLECTOARE DIN OTEL-INOX AISI 304L - 1"

Pentru utilizare cu caseta 1939 (pag. 287)

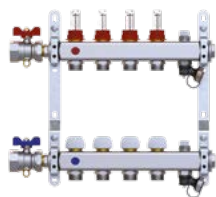

3871XT

Colector de distributie de 1" din otel inox AISI 304L cu iesiri 3/4"x18 (Eurocono) si indicatoare de debit.

Cod	Dimensiune	Cai	Pret €	Ambalare
387 0349	1"G	2		1/1
387 0350	1"G	3		1/1
387 0351	1"G	4		1/1
387 0352	1"G	5		1/1
387 0353	1"G	6		1/1
387 0354	1"G	7		1/1
387 0355	1"G	8		1/1
387 0356	1"G	9		1/1
387 0357	1"G	10		1/1
387 0358	1"G	11		1/1
387 0359	1"G	12		1/1

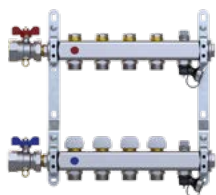

3875XT

Colector de distributie de 1" din otel inox AISI 304L cu iesiri 3/4"x18 (Eurocono) si vane cu memorie mecanica.

Cod	Dimensiune	Cai	Pret €	Ambalare
387 0360	1"G	2		1/1
387 0361	1"G	3		1/1
387 0362	1"G	4		1/1
387 0363	1"G	5		1/1
387 0364	1"G	6		1/1
387 0365	1"G	7		1/1
387 0366	1"G	8		1/1
387 0367	1"G	9		1/1
387 0368	1"G	10		1/1
387 0369	1"G	11		1/1
387 0370	1"G	12		1/1



2070

Termometru Ø 40 L=30 mm
scara 0 ÷ 80°C

Cod	Dimensiune	Pret €	Ambalare
179 0006	-		10/50

13_B SET COLECTOARE DIN OTEL-INOX AISI 304L - 1"

Pentru utilizare cu caseta 1939 (pag. 287)



3856X

Colector de distributie de 1" din otel inox AISI 304L cu iesiri 3/4"x18 (Eurocono) si indicatoare de debit.

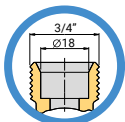

Cod	Dimensiune	Cai	Pret €	Ambalare
392 0059	1"G	2		1/1
392 0060	1"G	3		1/1
392 0061	1"G	4		1/1
392 0062	1"G	5		1/1
392 0063	1"G	6		1/1
392 0064	1"G	7		1/1
392 0065	1"G	8		1/1
392 0066	1"G	9		1/1
392 0067	1"G	10		1/1
392 0068	1"G	11		1/1
392 0069	1"G	12		1/1

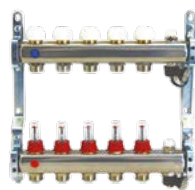

3855X

Colector de distributie de 1" din otel inox AISI 304L, iesiri 3/4"x18 (Eurocono), indicatoare de debit, supape de aerisire si robineti de golire

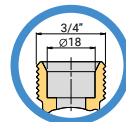

Cod	Dimensiune	Cai	Pret €	Ambalare
392 0081	1"G	2		1/1
392 0082	1"G	3		1/1
392 0083	1"G	4		1/1
392 0084	1"G	5		1/1
392 0085	1"G	6		1/1
392 0086	1"G	7		1/1
392 0087	1"G	8		1/1
392 0088	1"G	9		1/1
392 0089	1"G	10		1/1
392 0090	1"G	11		1/1
392 0091	1"G	12		1/1



3866X

Colector de distributie de 1" din otel inox AISI 304L cu iesiri 3/4"x18 (Eurocono) si vane cu memorie mecanica.

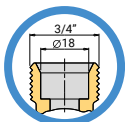

Cod	Dimensiune	Cai	Pret €	Ambalare
392 0070	1"G	2		1/1
392 0071	1"G	3		1/1
392 0072	1"G	4		1/1
392 0073	1"G	5		1/1
392 0074	1"G	6		1/1
392 0075	1"G	7		1/1
392 0076	1"G	8		1/1
392 0077	1"G	9		1/1
392 0078	1"G	10		1/1
392 0079	1"G	11		1/1
392 0080	1"G	12		1/1



3865X

Colector de distributie de 1" din otel inox AISI 304L, iesiri 3/4"x18 (Eurocono), vane cu memorie mecanica, supape de aerisire si robineti de golire

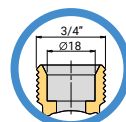

Cod	Dimensiune	Cai	Pret €	Ambalare
392 0092	1"G	2		1/1
392 0093	1"G	3		1/1
392 0094	1"G	4		1/1
392 0095	1"G	5		1/1
392 0096	1"G	6		1/1
392 0097	1"G	7		1/1
392 0098	1"G	8		1/1
392 0099	1"G	9		1/1
392 0100	1"G	10		1/1
392 0101	1"G	11		1/1
392 0102	1"G	12		1/1



13_B SET COLECTOARE DIN OTEL-INOX AISI 304L - 1"

Pentru utilizare cu caseta 1939 (pag. 287)



3891N
Kit terminal pentru colectoare
3856X - 3866X - 3856N - 3866N

Cod	Dimensiune	Pret €	Ambalare
450 0441	1"		1/10



3891NBY
Kit terminal cu by-pass pentru
colectoare 3856X - 3866X -
3856N - 3866N

Cod	Dimensiune	Pret €	Ambalare
450 0442	1"		1/10



3891NJ
Kit terminal pentru colectoare

Cod	Dimensiune	Pret €	Ambalare
450 0484	1"		1/5



3891NBYJ
Kit terminal cu by-pass pentru
colectoare

Cod	Dimensiune	Pret €	Ambalare
450 0485	1"		1/8

GHID DE ACCESORII

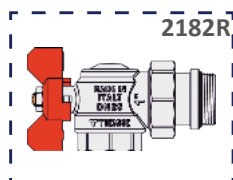

2182R



9567

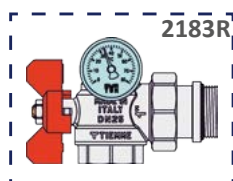

2183R

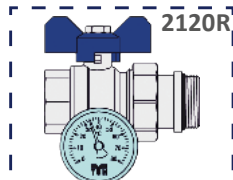

2120R

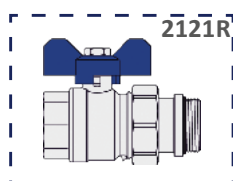

2121R

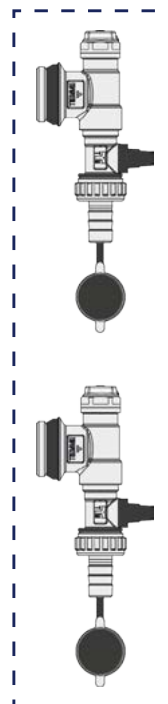
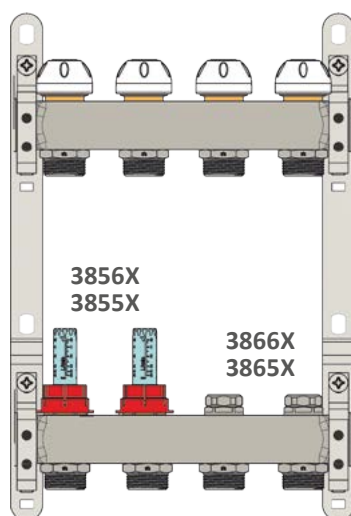

3891N
3891NJ

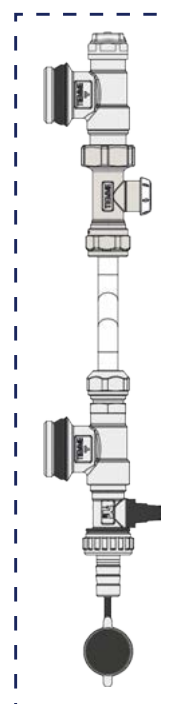



3891NBY
3891NBYJ

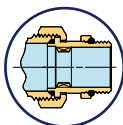

2121R

Set robineti drepti drept cu olandez si O-RING, cu pre-etansare



Cod	Dimensiune	Pret €	Ambalare
 maneta tip fluture rosie			
212 0013	1"		9/36
 maneta tip fluture albastra			
212 0014	1"		9/36



2121RSAC

Set robinet drept cu maneta tip fluture de culoare rosie si albastra cu olandez si garnitura O-RING, cu pre-etansare

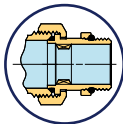

Cod	Dimensiune	Pret €	Ambalare
386 0035	1"		1/10



Nr 1 cu maneta tip fluture de culoare albastra + Nr 1 cu maneta tip fluture de culoare rosie

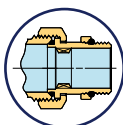

2182R

Robinet de colt cu olandez si garnitura O-RING, cu pre-etansare



Cod	Dimensiune	Pret €	Ambalare
 maneta tip fluture rosie			
212 0048	1"		5/20
 maneta tip fluture albastra			
212 0044	1"		5/20



2182RSAC

Set robineti M/F de colt ISO 228 cu maneta tip fluture de culoare rosie si albastra pentru colectoare, cu etansare si prindere pe O-RING, cu pre-etansare

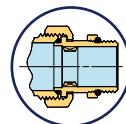

Cod	Dimensiune	Pret €	Ambalare
386 0032	1"		1/10

Nr 1 cu maneta tip fluture de culoare albastra + Nr 1 cu maneta tip fluture de culoare rosie



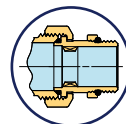

2120R

Robinet drept cu olandez, garnitura O-RING si termometru cu prindere reversibila, cu pre-etansare



BREVETAT

Cod	Dimensiune	Pret €	Ambalare
 maneta tip fluture rosie			
212 0043	1"		5/20
 maneta tip fluture albastra			
212 0042	1"		5/20



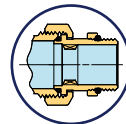

2183R

Robinet M/F de colt ISO 228 cu maneta tip fluture de culoare rosie sau albastra, cu pre-etansare, garnitura O-RING si termometru cu prindere reversibila, cu pre-etansare



BREVETAT

Cod	Dimensiune	Pret €	Ambalare
 maneta tip fluture rosie			
212 0031	1"		5/20
 maneta tip fluture albastra			
212 0032	1"		5/20

 Pentru gama completă de supape cu bilă, vezi capitolul 1 A



2114CPRKIT

Set robineti sfera cu olandez garnitura plata model drept compact, cu maneta tip fluture culoare rosie si albastra si termometre ce au conexiune reversibila

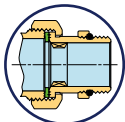

 BREVETAT

Cod	Dimensiune	Pret €	Ambalare
212 0195	1"		1/10



2184CPRKIT

Set robineti sfera cu olandez garnitura plata model coltar compact, cu maneta tip fluture culoare rosie si albastra si termometre ce au conexiune reversibila

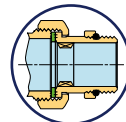

 BREVETAT

Cod	Dimensiune	Pret €	Ambalare
212 0197	1"		1/10



2116CPRKIT

Set robineti sfera cu olandez garnitura plata model drept compact, cu maneta tip fluture culoare rosie si albastra fara termometre

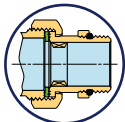

 BREVETAT

Cod	Dimensiune	Pret €	Ambalare
212 0196	1"		1/10



2186CPRKIT

Set robineti sfera cu olandez garnitura plata model coltar compact, cu maneta tip fluture culoare rosie si albastra fara termometre

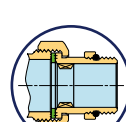

 BREVETAT

Cod	Dimensiune	Pret €	Ambalare
212 0198	1"		1/10



9567

Servocomanda electrotermica pentru robinet termostaticabil de inchidere cu indicator de cursa.

NORMAL INCHIS

Cod	Dimensiune	Pret €	Ambalare
450 0026	24V		1/20
450 0012	230V		1/20
450 0045	24V		1/20
450 0006	230V		1/20

Versiuni cu microinterruptor auxiliar



H9709

Indicatoare de debit pentru Colector de distributie FLOOR

Cod	Dimensiune	Pret €	Ambalare
040 0196	-		5/100



H9708

Ventil termostaticabil pentru colector de distributie FLOOR

Cod	Dimensiune	Pret €	Ambalare
040 0241	-		10/50



2070

Termometru Ø 40 L=30 mm scara 0 ÷ 80°C

Cod	Dimensiune	Pret €	Ambalare
179 0006	-		10/50



3352

Supapa de aerisire pentru radiatoare

Cod	Dimensiune	Pret €	Ambalare
198 0047	3/8"		10/500
198 0018	1/2"		10/500



2990G

Robinet cu sfera pentru golire



Cod	Dimensiune	Pret €	Ambalare
295 0001	1/2"		25/100
295 0040	1/2"		10/50

Varianta cu lant metalic

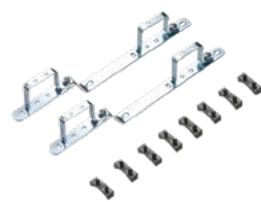

1863

Set de prindere pentru colectoare "FLOOR" pentru caseta Art. 1931-1939-1940

Cod	Dimensiune	Pret €	Ambalare
181 0032	1"		1/25
181 0203	1"1/4		1/25





1939

Caseta reglabila pe inaltime si in adancime pentru colectoare tip bara si "FLOOR". Necesita seturi de prindere art. 1865-1864 in functie de diametrul colectorului

i Adancime reglabila de la 90 mm la 140 mm

Cod	Dimensiune	Pret €	Ambalare
181 0192	400 x 660 x 90 ÷ 140		1/1
181 0193	500 x 660 x 90 ÷ 140		1/1
181 0206	600 x 660 x 90 ÷ 140		1/1
181 0194	700 x 660 x 90 ÷ 140		1/1
181 0195	1000 x 660 x 90 ÷ 140		1/1

1939

DIMENSIUNE

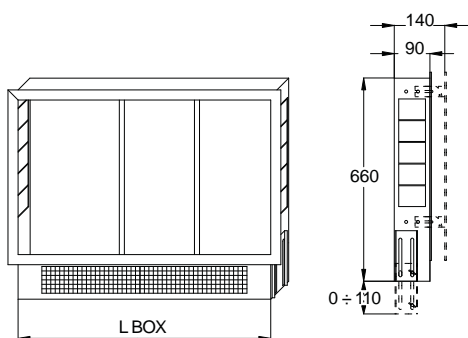

GHID DE ALEGERE A CASETELOR

COMPATIBILITATEA COLECTORULUI

3873J - 3873BYD - 3878 - 3878BYD - 3049 - 3049I - 3050 3050I - 3856N - 3866N - 3856X - 3866X - 3855X - 3865X

Nr. circuite	L* (mm)	L BOX (mm)	Cod
2	232	400	181 0192
3	282		
4	332		
5	382	500	181 0193
6	432		
7	482	600	181 0206
8	532		
9	582	700	181 0194
10	632		
11	682	1000	181 0195
12	732		
13	782		
14	832		

* Latimea colectorului



1940

Caseta reglabila pe inaltime si in adancime pentru grupuri de amestec si distributie si colectoare.

Necesita seturi de prindere

i Adancime reglabila de la 120 mm la 170 mm

Cod	Dimensiune	Pret €	Ambalare
181 0020	600 x 670 x 120 ÷ 170		1/1
181 0016	700 x 670 x 120 ÷ 170		1/1
181 0015	850 x 670 x 120 ÷ 170		1/1
181 0019	1000 x 670 x 120 ÷ 170		1/1
181 0025	1200 x 670 x 120 ÷ 170		1/1

1940

DIMENSIUNE

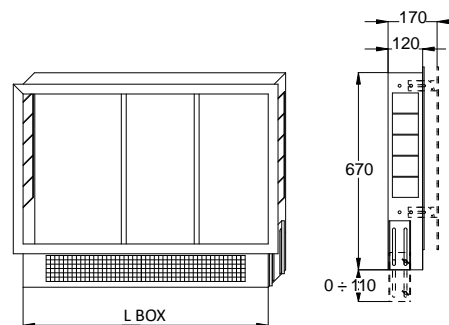

GHID DE ALEGERE A CASETELOR

COMPATIBILITATEA COLECTORULUI

3873RJ - 3873RBYDJ - 3878R - 3878RBYD - 3877 - 3877BYD - 3879 - 3879BYD - 3877R - 3877RBYD - 3879R - 3879RBYD

Nr. circuite	L* (mm)	L BOX (mm)	Cod
2	262	600	181 0020
3	312		
4	362		
5	412		
6	462	700	181 0016
7	512		
8	562		
9	612	850	181 0015
10	662		
11	712		
12	762		

* Latimea colectorului

i - Pentru produsele art. 3049 - 3049I - 3050 - 3050I - 3856N - 3866N - 3856X - 3866X - 3855X - 3865X dimensiunea L include robinetii cu sfera și seturi de terminale ca accesorii



1436

Pentru tub PEX

Adaptor pentru conexiuni
3/4"x18 (EUROCONO)

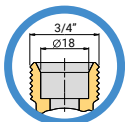

Cod	Dimensiune	Pret €	Ambalare
144 0099	16 x 2,0 - 3/4"(ø18)		10/250
144 0085	17 x 2,0 - 3/4"(ø18)		10/200
144 0089	20 x 2,0 - 3/4"(ø18)		10/200



1636

Pentru tub MULTISTRAT

Adaptor pentru conexiuni
3/4"x18 (EUROCONO)

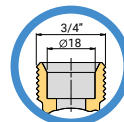

Cod	Dimensiune	Pret €	Ambalare
144 0080	16 x 2,0 - 3/4"(ø18)		10/250
144 0172	17 x 2,0 - 3/4"(ø18)		10/200
144 0100	20 x 2,0 - 3/4"(ø18)		10/200



1436N

Pentru tub PEX

Adaptor pentru conexiuni
3/4"x18 (EUROCONO)
Versiunea nichelata

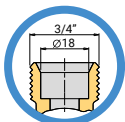

Cod	Dimensiune	Pret €	Ambalare
144 0011	16 x 2,0 - 3/4"(ø18)		10/250
144 0012	17 x 2,0 - 3/4"(ø18)		10/200
144 0019	20 x 2,0 - 3/4"(ø18)		10/200



1636N

Pentru tub MULTISTRAT

Adaptor pentru conexiuni
3/4"x18 (EUROCONO)
Versiunea nichelata

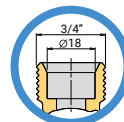

Cod	Dimensiune	Pret €	Ambalare
144 0002	16 x 2,0 - 3/4"(ø18)		10/250
144 0033	17 x 2,0 - 3/4"(ø18)		10/200
144 0003	20 x 2,0 - 3/4"(ø18)		10/200



13_B SET COLECTOARE "INDUSTRIAL FLOOR" DIN ALAMA STANTATA – 1" 1/2

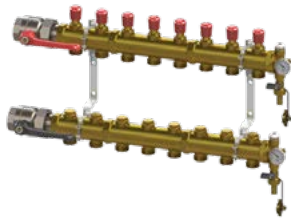

3874

Colector de distributie INDUSTRIAL FLOOR de 1"1/2 stantat din alama cu iesiri 1" M si robineti manuali

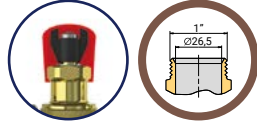

DESCRIERE:

Colector de distributie pentru incalzire in pardoseala din alama de 1"1/2 alcatuit din:

- Colector de tur si retur din alama CW617N conform normei EN12165
- Iesiri 1" cu robinet de reglare pe tur
- Robineti cu sfera 1"1/2 pe alimentare
- Termometre
- Robineti de incarcare/descarcare
- Supapa manuala de aerisire
- Set de prindere

Cod	Dim.	Cai	Iesiri	Pret €	Ambalare
385 0074	1"1/2G	5	1"G		1/1
385 0075	1"1/2G	6	1"G		1/1
385 0076	1"1/2G	7	1"G		1/1
385 0077	1"1/2G	8	1"G		1/1
385 0078	1"1/2G	9	1"G		1/1
385 0079	1"1/2G	10	1"G		1/1
385 0080	1"1/2G	11	1"G		1/1
385 0081	1"1/2G	12	1"G		1/1
385 0082	1"1/2G	13	1"G		1/1
385 0083	1"1/2G	14	1"G		1/1

3874

GHID DE CONEXIUNI

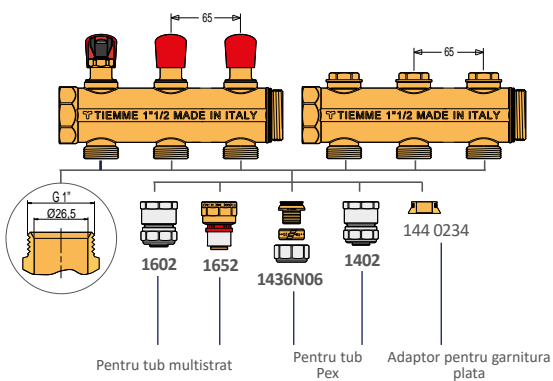

1436N06

Adaptor pentru conexiuni 1" pentru tub PEX

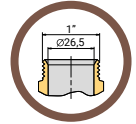

Cod	Dimensiune	Pret €	Ambalare
144 0232	20 x 2,0 - 1" G		10/200
144 0075	25 x 2,3 - 1" G		10/200



1859

Adaptor pentru conexiuni 1" G

Cod	Dimensiune	Pret €	Ambalare
144 0234	1"G		10/300



3874P

Capac de protectie

Cod	Dimensiune	Pret €	Ambalare
179 0037	-		5/50



1889TERMO

Teu feminin cu filet fazat si suport termometru

Cod	Dimensiune	Pret €	Ambalare
195 0064	1"1/2 x 1/2" x 1/2"		5/50

13_B SET COLECTOARE "INDUSTRIAL FLOOR" DIN ALAMA STANTATA - 1" 1/2



9567KIT
Adaptor INDUSTRIAL FLOOR
pentru servocomanda
electrotermica 9567

Cod	Dimensiune	Pret €	Ambalare
179 0328	-		1/100

9567-9567KIT INSTRUȚIUNI DE MONTAJ

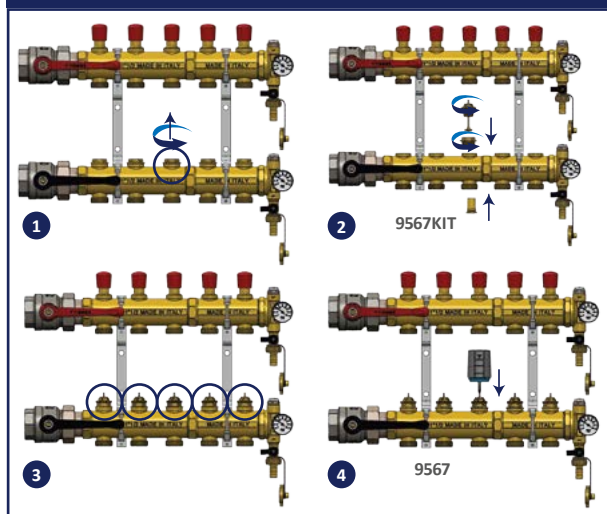

1

2

9567KIT

3

4

9567

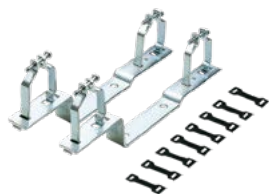

1865
Set de prindere universal pentru
colectoare stantate "INDUSTRIAL
FLOOR"

Cod	Dimensiune	Pret €	Ambalare
181 0007	1"1/2		1/25



1941
Casetă externă pentru
colectoare "INDUSTRIAL FLOOR"

Cod	Dimensiune	Pret €	Ambalare
181 0110	900 x 650 x 170		1/1
181 0111	1200 x 650 x 170		1/1

1941 DIMENSIUNE

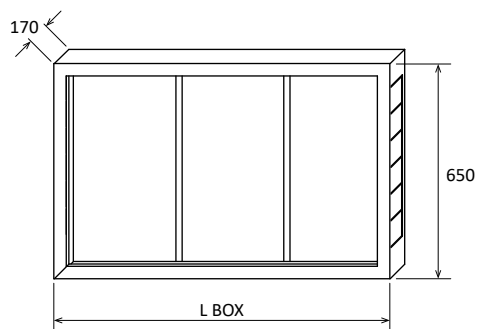

GHID DE ALEGEREA CASETELOR

COMPATIBILITATEA COLECTORULUI

Nr. circuite	L* (mm)	L BOX (mm)	Cod
5	495	900	181 0110
6	560		
7	625		
8	690		
9	755		
10	820	1200	181 0111
11	885		
12	950		
13	1015		
14	1080		

* Latimea colectorului



NOUȚĂȚI



3898N

Grup de amestec pentru instalatii radiante. Versiunea nichelata

DESCRIERE

- Termostat de siguranță temperatură fixă (55°C)
- 1 Termometru (temperatură tur)
- By-pass
- Supapă de sens

Cod	Dimensiune	Pret €	Ambalare
389 0049	Fără pompă		1/5
389 0050	Wilo PARA 25/7		1/1

ErP READY

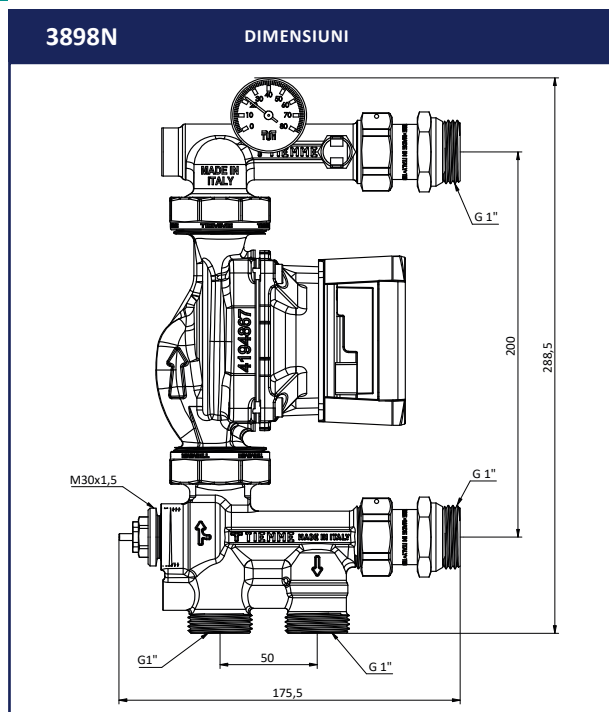

NOUȚĂȚI



3898KHT

Kit de distribuție de înaltă temperatură

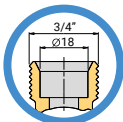

DESCRIERE:

Kit compus din:

- Colectoare de distribuție din alama 1" 3 căi cu racorduri 3/4"x18 Eurocono și robineti termostatizabili
- Colectoare de distribuție din alama 1" 3 căi cu racorduri 3/4"x18 Eurocono și vane cu memorie mecanică
- Accesorii de conectare

Cod	Dimensiune	Pret €	Ambalare
450 0715	1" 3 căi		1/2

NOUȚĂȚI



2286KIT

Set robineti drept M ISO 228 cu piulita și maneta tip fluture culoare roșie și albastră

Cod	Dimensiune	Pret €	Ambalare
226 0200	1"		1/25

NOUȚĂȚI



3898I

Izolație termică termoformată pentru grup de amestec

Cod	Dimensiune	Pret €	Ambalare
557 0698	3898N		1/1

La cerere

NOUȚĂȚI



3898IHT

Izolație termică termoformată pentru kit de distribuție de înaltă temperatură

Cod	Dimensiune	Pret €	Ambalare
557 0695	3898KHT		1/1

La cerere



1931

Caseta din metal prevăzută cu seturi pentru kit de amestec

Adâncime reglabilă de la 120 mm la 170 mm

Cod	Dimensiune	Pret €	Ambalare
181 0255	600 x 670 x 120 ÷ 170		1/1

Noutati



3895KPF

Kit de reglare cu punct fix setabil (20÷50°C)



DESCRIERE:

Kit compus din:

- Cap termostatic cu sondă la distanță și câmp de reglare 20÷50°C
- Teacă port sondă (cod.040 0180)
- Casetă legături electrice (pompa și termostat de siguranță)

Cod	Dimensiune	Pret €	Ambalare
450 0376	-		1/1



3895KCL

Kit de reglare a temperaturii pentru incalzire/racire



DESCRIERE:

Kit compus din:

- Servocomanda 0÷10V NC cu alimentare 24V
- Teacă port sondă Ø6 montaj uscat
- Cablu de legatura pentru termostatul de siguranta
- Sonda de temperatura NTC 10K@25°C, diametru 6 mm

Cod	Dimensiune	Pret €	Ambalare
450 0377	-		1/1

3898N

EXEMPLU DE UTILIZARE

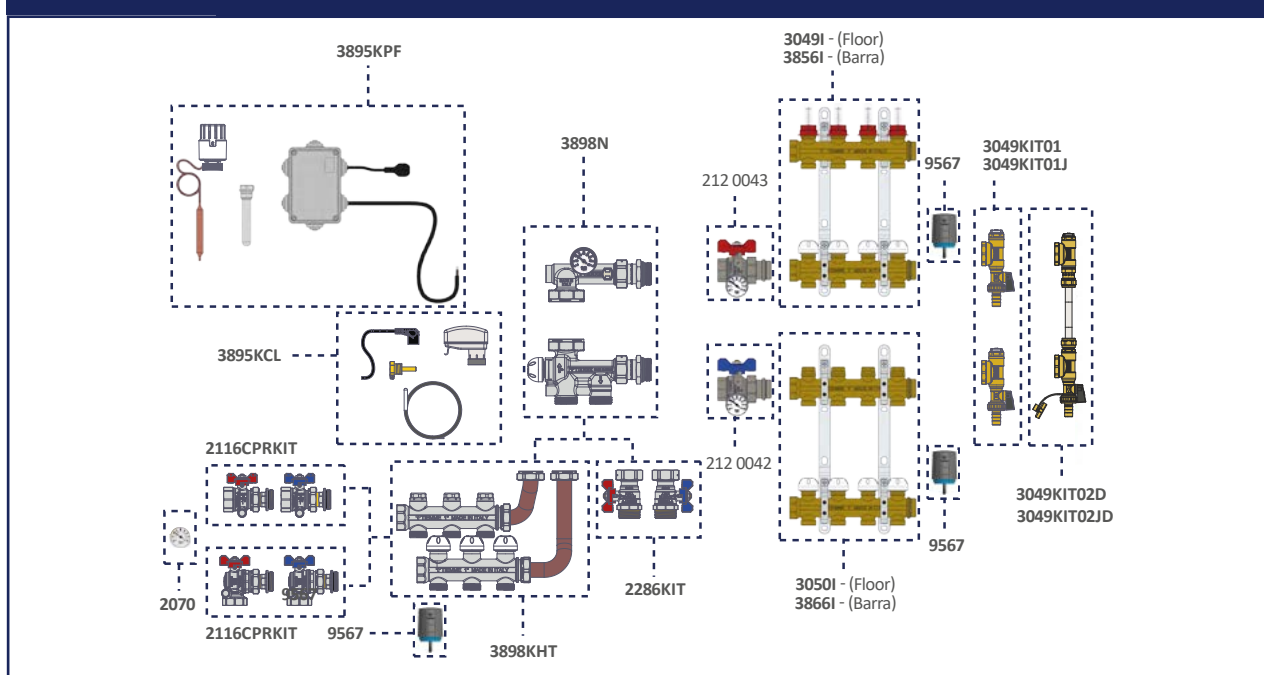

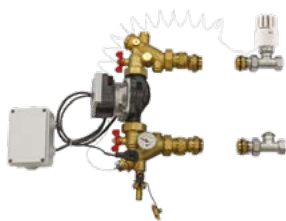

3899G3

Grup de amestec si distributie premontat cu robinet drept termostatic

DESCRIERE:

- Racorduri pentru alimentare pe 3/4" F
- Robinet termostatic drept cu comanda 20-50°C
- Pompa de circulatie
- Kit de conexiuni electrice
- Termostate de siguranta cu punct fix 55°C (EN1264)
- Termometru (inclus)
- Supapa de aerisire si robineti de incarcare/descarcare
- Racorduri cu preetansare nealiniata (30 mm) pentru colectoare de distributie premontate (art. 3856 sau 3866)

Cod	Dim.	Model pompa	Pret €	Ambalare
389 0023	1"	Fără pompă		1/1
389 0008	1"	Wilo PARA 25/7		1/1

ErP READY

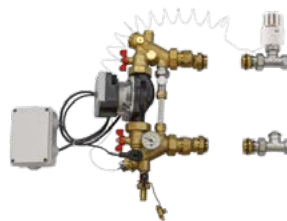

3899G3BY

Grup de amestec si distributie premontat cu robinet drept termostatic

DESCRIERE:

- Racorduri pentru alimentare pe 3/4" F
- Robinet termostatic drept cu comanda 20-50°C
- Detentor de echilibrare
- Pompa de circulatie
- Kit de conexiuni electrice
- Termostate de siguranta cu punct fix 55°C (EN1264)
- Termometru (inclus)
- Supapa de aerisire si robineti de incarcare/descarcare
- Racorduri cu preetansare nealiniata (30 mm) pentru colector de distributie premontate (art. 3049, 3050, 3856 e 3866)
- By-pass cu detentor de echilibrare

CU BY-PASS

Cod	Dim.	Model pompa	Pret €	Ambalare
389 0024	1"	Fără pompă		1/1
389 0009	1"	Wilo PARA 25/7		1/1

ErP READY



1940

Caseta reglabila în înaltime si adancime pentru grupuri de amestec si distributie

i Adancime reglabila de la 120 mm la 170 mm

Cod	Dimensiune	Pret €	Ambalare
181 0020	600 x 670 x 120 ÷ 170		1/1
181 0016	700 x 670 x 120 ÷ 170		1/1
181 0015	850 x 670 x 120 ÷ 170		1/1
181 0019	1000 x 670 x 120 ÷ 170		1/1
181 0025	1200 x 670 x 120 ÷ 170		1/1

EXEMPLU DE UTILIZARE

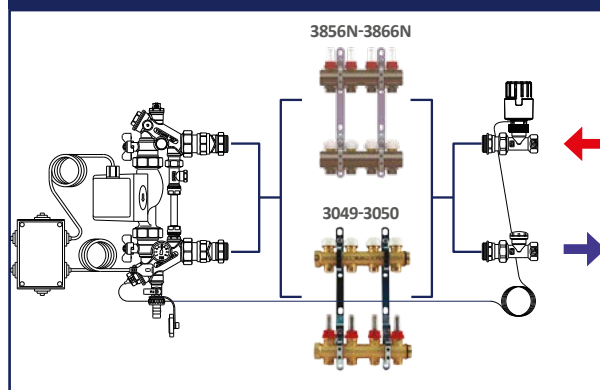

GHID DE ALEGEREA CASETELOR

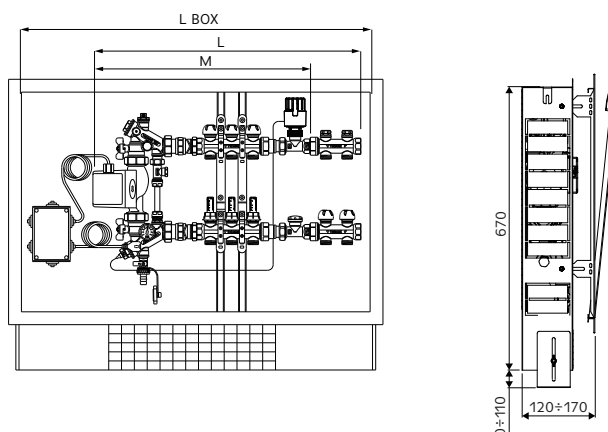

ALEGEREA CUTIEI

N. circuite	2	3	4	5	6	7	8	9	10	11	12
M (mm)	460	510	560	610	660	710	760	810	860	910	960
L BOX (mm)	600		700			850			1000		1200
Cod	181 0020		181 0016			181 0015			181 0019		181 0025

ALEGEREA CUTIEI PENTRU COLECTOARE CU 2 CIRCUITE SUPLIMENTARE DE INALTA TEMPERATURA

N. circuite	2	3	4	5	6	7	8	9	10	11	12
L (mm)	580	630	680	730	780	830	880	930	980	1030	1080
L BOX (mm)	700		850			1000			1200		
Cod	181 0016		181 0015			181 0019			181 0025		

ALEGEREA CUTIEI PENTRU COLECTOARE CU 3 CIRCUITE SUPLIMENTARE DE INALTA TEMPERATURA

N. circuite	2	3	4	5	6	7	8	9	10	11	12
L (mm)	630	680	730	780	830	880	930	980	1030	1080	1130
L BOX (mm)	700		850			1000			1200		
Cod	181 0016		181 0015			181 0019			181 0025		





3890VD

Vana termostatică cu 3 cai deviație/amestec pentru gestiunea instalațiilor de încălzire și răcire.

În funcție de poziția de montaj funcționează ca vana deviatoare sau ca vana de amestec.

Cod	Dimensiune	Pret €	Ambalare
450 0047	1"		2/20
450 0515	1"1/4		1/10
450 0516	1"1/2		1/10

3890VD

GHID DE INSTALARE

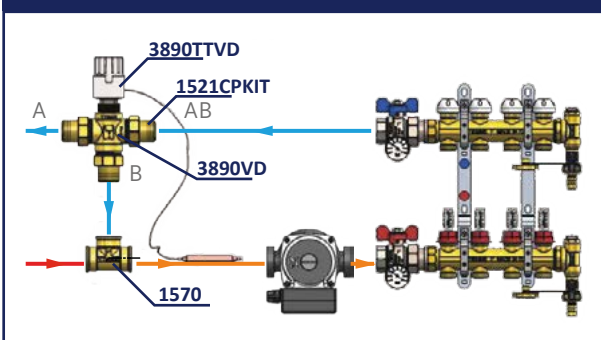

3890VDKIT

Kit olandez pentru Vana termostatică cu 3 cai deviație/amestec

i Kit-ul cuprinde: 3 stuturi filetate, 3 piulite, 3 garnituri

Cod	Dimensiune	Pret €	Ambalare
150 1017	1" F x 3/4" M		1/20
150 1013	1"1/4 F x 1" M		1/15
150 1014	1"1/2 F x 1"1/4 M		1/10



1570

Teu F

Cod	Dimensiune	Pret €	Ambalare
150 0009	3/4" x 3/4" x 3/4"		5/50
150 0005	1" x 1" x 1"		5/25
150 0029	1"1/4 x 1"1/4 x 1"1/4		5/20



3890TTVD

Cap termostatic cu sonda la distanță pentru supapa de deviere

Cod	Dimensiune	Pret €	Ambalare
450 0527	20 - 50°C		1/10
450 0556	40 - 70°C		1/10

13_B GRUP DE AMESTEC SI DISTRIBUTIE CU PUNCT FIX - 1"

3868G - 3868GHPPP2 - 3868GHPPP3

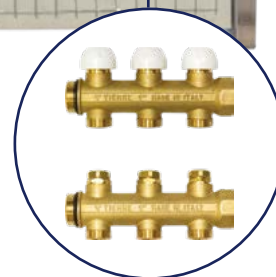
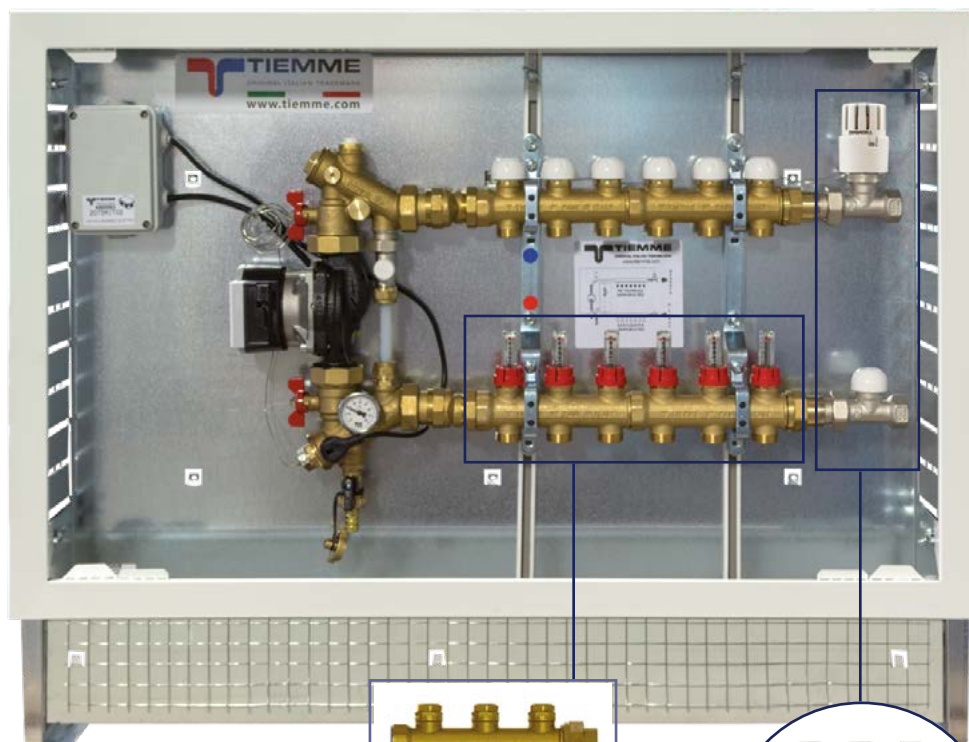

VERSIUNEA CU COLECTOR
SUPLIMENTAR DE
TEMPERATURA INALTA

DESCRIERE

Grup de amestec și distribuție pentru sisteme radiante pre-asamblat într-o cutie metalică format din:

- Kit de amestec cu reglare punct fix
- Pompă de circulație de înaltă eficiență (EEI 0.23) cu viteză variabilă și magneți permanenți.
- Distribuitor modular de tur complet cu reglare a debitului prin intermediul debitmetrelor cu ieșiri de 3/4 "x18 (Eurocon)
- Distribuitor modular de retur cu supape de închidere termostatică cu ieșiri de 3/4 "x18 (Eurocon)
- Ventil de aerisire și robinet de încărcare/descărcare
- Modele disponibile cu kit de temperatură înaltă cu 2 - 3 căi pentru calorifere
- Îveliș izolator din spumă de polietilenă termoformată

DIMENSIUNE

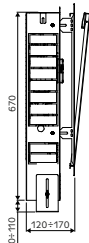
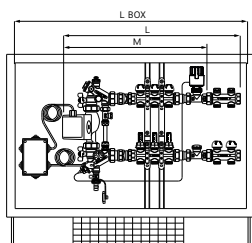

Pentru tabelul de dimensiuni vezi pagina anterioară



13_B GRUP DE AMESTEC SI DISTRIBUTIE CU PUNCT FIX - 1"

3868G - 3868GHTPP2 - 3868GHTPP3



3868G

Grup de amestec și distribuție cu punct fix și by-pass

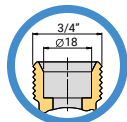

Cod	Dimensiune	Cai	Pret €	Ambalare
391 0103	1"G	2		1/1
391 0110	1"G	3		1/1
391 0101	1"G	4		1/1
391 0098	1"G	5		1/1
391 0028	1"G	6		1/1
391 0077	1"G	7		1/1
391 0064	1"G	8		1/1
391 0111	1"G	9		1/1
391 0071	1"G	10		1/1
391 0059	1"G	11		1/1
391 0062	1"G	12		1/1
Versiunea cu vane cu memorie mecanica				
391 0112	1"G	2		1/1
391 0113	1"G	3		1/1
391 0102	1"G	4		1/1
391 0114	1"G	5		1/1
391 0079	1"G	6		1/1
391 0099	1"G	7		1/1
391 0115	1"G	8		1/1
391 0093	1"G	9		1/1
391 0116	1"G	10		1/1
391 0092	1"G	11		1/1
391 0117	1"G	12		1/1

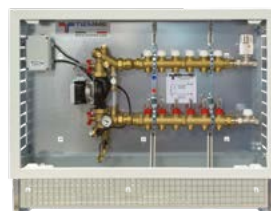

3868GHTPP2

Grup de amestec și distribuție cu reglare punct fix, by-pass și kit de temperatură înaltă în 2 cai

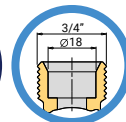

Cod	Dimensiune	Cai	Pret €	Ambalare
391 0118	1"G	2		1/1
391 0097	1"G	3		1/1
391 0074	1"G	4		1/1
391 0036	1"G	5		1/1
391 0047	1"G	6		1/1
391 0029	1"G	7		1/1
391 0058	1"G	8		1/1
391 0052	1"G	9		1/1
391 0051	1"G	10		1/1
391 0061	1"G	11		1/1
391 0128	1"G	12		1/1
Versiunea cu vane cu memorie mecanica				
391 0130	1"G	2		1/1
391 0132	1"G	3		1/1
391 0053	1"G	4		1/1
391 0010	1"G	5		1/1
391 0024	1"G	6		1/1
391 0067	1"G	7		1/1
391 0044	1"G	8		1/1
391 0022	1"G	9		1/1
391 0040	1"G	10		1/1
391 0089	1"G	11		1/1
391 0054	1"G	12		1/1

13_B GRUP DE AMESTEC SI DISTRIBUTIE CU PUNCT FIX - 1"

3868G - 3868GHTPP2 - 3868GHTPP3

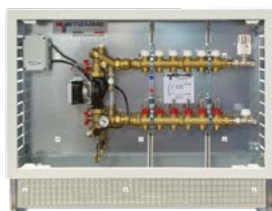

3868GHTPP3

Grup de amestec si distributie
cu punct fix cu iesiri 3/4"x18
(Euro-con), by-pass si colector
de temperatura inalta 3 cai

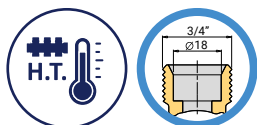

Cod	Dimensiune	Cai	Pret €	Ambalare
391 0119	1"G	2		1/1
391 0120	1"G	3		1/1
391 0121	1"G	4		1/1
391 0122	1"G	5		1/1
391 0123	1"G	6		1/1
391 0124	1"G	7		1/1
391 0125	1"G	8		1/1
391 0126	1"G	9		1/1
391 0085	1"G	10		1/1
391 0127	1"G	11		1/1
391 0129	1"G	12		1/1
Versiunea cu vane cu memorie mecanica				
391 0131	1"G	2		1/1
391 0133	1"G	3		1/1
391 0134	1"G	4		1/1
391 0135	1"G	5		1/1
391 0136	1"G	6		1/1
391 0088	1"G	7		1/1
391 0137	1"G	8		1/1
391 0084	1"G	9		1/1
391 0087	1"G	10		1/1
391 0073	1"G	11		1/1
391 0138	1"G	12		1/1



13_B GRUP DE AMESTEC SI DISTRIBUTIE CU PUNCT FIX - 1"

3896PF - 3896PFBYD - 3896PFHT - 3896PFHTBYD



PÂNĂ LA TERMINAREA STOCULUI

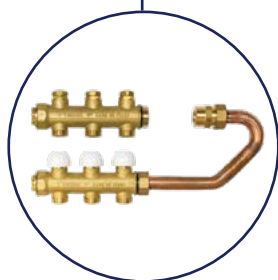
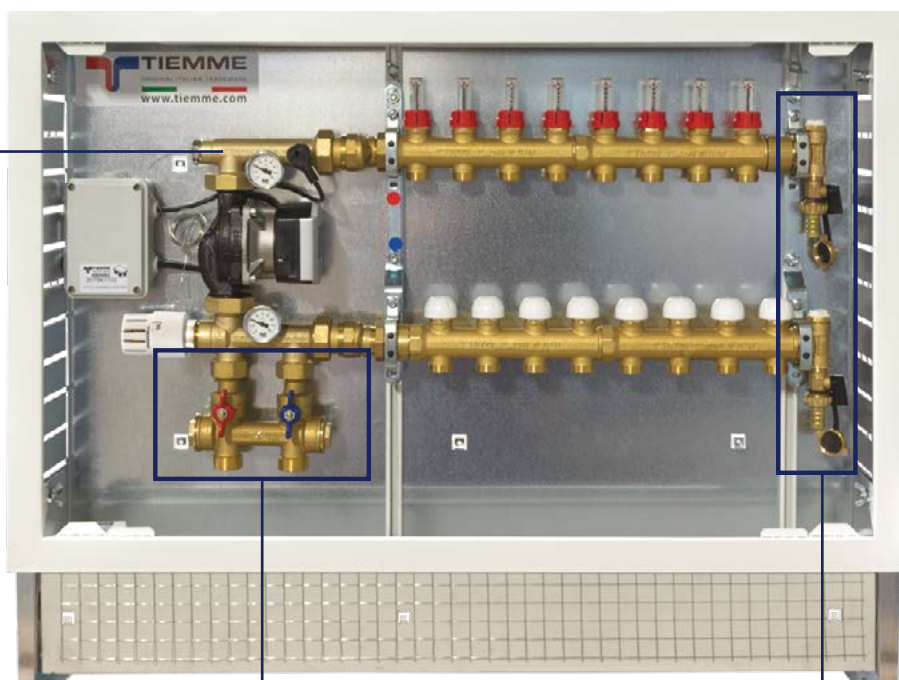

VERSIUNEA CU COLECTOR SUPPLEMENTAR DE TEMPERATURA INALTA



VERSIUNE CU BY-PASS DIFERENTIAL

DESCRIERE

Grup de amestec și distribuție pentru sisteme radiante pre-asamblat într-o cutie metalica format din:

- Kit de amestec cu reglare punct fix
- Pompă de circulație de înaltă eficiență (EEI 0.23) cu viteză variabilă și magneți permanenți.
- Distribuitor modular de tur complet cu reglare a debitului prin intermediul debitmetrelor cu ieșiri de 3/4 "x18 (Eurocon)
- Distribuitor modular de retur cu supape de închidere termostatică cu ieșiri de 3/4 "x18 (Eurocon)
- Ventil de aerisire și robinet de încărcare/descărcare
- Sunt disponibile modelele cu by-pass și kit cu 3 căi de înaltă temperatură pentru radiatoare

DIMENSIUNE

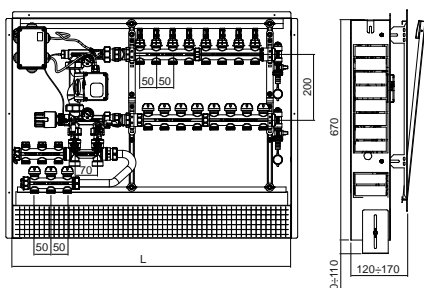

N. circuite	2	3	4	5	6	7	8	9	10	11	12
L (mm)	600	700	850	1000	1200						

13_B GRUP DE AMESTEC SI DISTRIBUTIE CU PUNCT FIX - 1"

3896PF - 3896PFBYD - 3896PFHT - 3896PFHTBYD

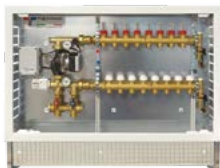

3896PF

Grup de amestec și distribuție cu reglare cu punct fix

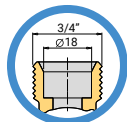

Cod	Dimensiune	Cai	Pret €	Ambalare
390 0444	1"G	2		1/1
390 0445	1"G	3		1/1
390 0446	1"G	4		1/1
390 0447	1"G	5		1/1
390 0448	1"G	6		1/1
390 0449	1"G	7		1/1
390 0450	1"G	8		1/1
390 0451	1"G	9		1/1
390 0452	1"G	10		1/1
390 0453	1"G	11		1/1
390 0454	1"G	12		1/1



3896PFHT

Grup de amestec și distribuție cu reglare punct fix și kit de temperatură înaltă

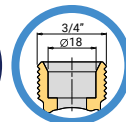

Cod	Dimensiune	Cai	Pret €	Ambalare
390 0488	1"G	2		1/1
390 0489	1"G	3		1/1
390 0490	1"G	4		1/1
390 0491	1"G	5		1/1
390 0492	1"G	6		1/1
390 0493	1"G	7		1/1
390 0494	1"G	8		1/1
390 0495	1"G	9		1/1
390 0496	1"G	10		1/1
390 0497	1"G	11		1/1
390 0498	1"G	12		1/1



3896PFBYD

Grup de amestec și distribuție cu punct fix și by-pass diferential



Cu by-pass diferential

Cod	Dimensiune	Cai	Pret €	Ambalare
390 0466	1"G	2		1/1
390 0467	1"G	3		1/1
390 0468	1"G	4		1/1
390 0469	1"G	5		1/1
390 0470	1"G	6		1/1
390 0471	1"G	7		1/1
390 0472	1"G	8		1/1
390 0473	1"G	9		1/1
390 0474	1"G	10		1/1
390 0475	1"G	11		1/1
390 0476	1"G	12		1/1



3896PFHTBYD

Grup de amestec și distribuție cu reglare punct fix, by-pass diferential și kit de temperatură înaltă

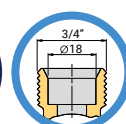

Cu by-pass diferential

Cod	Dimensiune	Cai	Pret €	Ambalare
390 0510	1"G	2		1/1
390 0511	1"G	3		1/1
390 0512	1"G	4		1/1
390 0513	1"G	5		1/1
390 0514	1"G	6		1/1
390 0515	1"G	7		1/1
390 0516	1"G	8		1/1
390 0517	1"G	9		1/1
390 0518	1"G	10		1/1
390 0519	1"G	11		1/1
390 0520	1"G	12		1/1





9567

Servocomanda electrotermica pentru robinet termostaticabil de inchidere cu indicator de cursa.

NORMAL INCHIS

Cod	Dimensiune	Pret €	Ambalare
450 0026	24V		1/20
450 0012	230V		1/20
450 0045	24V		1/20
450 0006	230V		1/20

Versiuni cu microintrerupator auxiliar



9561KIT01

Cap termostatic cu sonda la distanta si teaca cu racord 1/2". Domeniu de reglare 20-50°C

Cod	Dimensiune	Pret €	Ambalare
450 0032	20-50°C		1/10



2075KIT02

Set de conexiuni electrice pentru grupul de mixare, gestionarea pompei de circulație, contact auxiliar pentru boilerul sau supapa de zonă, intrare pentru termostat ambiental și termostat de siguranță, cutie de borne detașabilă pentru facilitarea activității instalatorului

i Regleta detasabila pentru a facilita munca instalatorului

i Se livreaza complet cu cabluri pentru conectarea pompei de circulatie si a termostatului de siguranta

Cod	Dimensiune	Pret €	Ambalare
450 0063	120 x 80 x H60 mm		1/1



2075KIT01

Termostat de siguranta bimetalic cu pastila si surub de fixare M4. Temperatura de interventie 55°C. Tip contact (normal inchis) 10 A 250 Vac. Furnizat impreuna cu cablul de conexiune

Cod	Dimensiune	Pret €	Ambalare
450 0051	55°C		1/50



3049SKIT

Kit de fixare a colectoarelor FLOOR

Cod	Dimensiune	Pret €	Ambalare
385 0063	1"		1/5



3890SKIT

Kit de fixare a colectoarelor bara

Cod	Dimensiune	Pret €	Ambalare
181 0043	1"		1/5

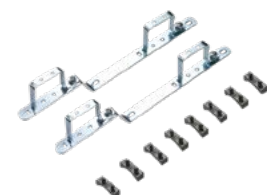

1863

Set de prindere pentru colectoare "FLOOR" pentru caseta Art. 1931-1939-1940

Cod	Dimensiune	Pret €	Ambalare
181 0032	1"		1/25
181 0203	1"1/4		1/25



1864P

Suport pentru fixarea direct pe perete a colectorei bară de 1"-1"1/4

Cod	Dimensiune	Pret €	Ambalare
181 0041	1"		1/25
181 0042	1"1/4		1/25



3891G0001
Kit terminal cu by-pass pentru grupuri de amestec si distributie 3899

Cod	Dimensiune	Pret €	Ambalare
450 0065	unica		1/6



3887
Robinet cu sfera multifunctional pentru grupuri de amestec si distributie

Cod	Dimensiune	Pret €	Ambalare
450 0050	1"		2/6



3890PW2
Pompa de circulatie de inalta eficienta Wilo PARA 25/7 cu interaxă 130 mm. Iesire 1" 1/2 corp de fontă

+ POMPA DE MARE EFICIENTA

Cod	Dimensiune	Pret €	Ambalare
450 0358	Wilo PARA 25/7		1/1



3890P
Pompa de circulație cu trei viteze. Iesiri de 1"1/2 interaxă 130 mm

Cod	Dimensiune	Pret €	Ambalare
450 0033	Grundfos UPS 25-55		1/1

Disponibila pentru tari non UE



3889
Olandez pompa 1"1/2 cu robinet sfera inCorprat, actionabil cu cheie hexagonala cu filet 1" interior

Cod	Dim.	Atac pompa	Pret €	Ambalare
450 0031	1"	1"1/2		2/40



3888
Olandez pompa 1"1/2 cu robinet sfera inCorprat, actionabil cu cheie hexagonala si legatura pentru teava cupru

Cod	Dim.	Atac pompa	Pret €	Ambalare
450 0041	22	1"1/2		1/50
450 0044	28	1"1/2		1/50



1555SET
Set olandez din alama pentru pompa cu racorduri M/F si garnitura plata.

i Setul include: 2 stuturi, 2 piulițe, 2 garnituri

Cod	Dim.	Atac pompa	Pret €	Ambalare
150 0825	1/2"	3/4"		1/50
150 0826	3/4"	1"		1/50
150 0827	1"	1"1/4		1/25
150 0578	1"1/4	1"1/2		1/20



1557SET
Set olandez din alama pentru pompa cu racorduri F/F si **GARNITURA PLATA**.
150 0355 pentru pompele: 35/130, 55/130, 65/130;
art.150 0440 pentru pompele: 50/180, 80/180, 110/180

i Setul include: 2 stuturi, 2 piulițe, 2 garnituri

Cod	Dim.	Atac pompa	Pret €	Ambalare
150 0906	1/2"	1"		1/50
150 0839	3/4"	1"1/4		1/25
150 0355	1"	1"1/2		1/20
150 0440	1"1/4	2"		1/10

14 TERMOREGLARE

Termostate si cronotermostate



304

Umidostate si cronoumidostate



306

Sisteme de termoreglare wireless



307

Sisteme de termoreglare Wi-Fi **TIEMME GATE >>**



309

Sisteme de termoreglare Wi-Fi **TIEMME NEXT >>**



310

Termostate de siguranta



311





9575
Termostat de ambient electromecanic

CARACTERISTICI TEHNICE:

- Iesire: contact normal deschis 16 (2,5) A/250 Vac
- Domeniu de reglare: 5 – 30°C
- Grad de precizie: ± 0,5°C

Cod	Dimensiune	Pret €	Ambalare
957 0002	electromecanic		1/40



9587
Termostat electronic digital montat pe perete pentru controlul temperaturii camerei atât la încălzire, cât și la racire. Alimentare pe baterii.

CARACTERISTICI TEHNICE:

- Alimentare: 2 baterii AAA de 1,5 V
- Durata bateriei: 1 an
- Domeniu de reglare: 2 – 35°C
- Grad de precizie: ± 0,5°C

Cod	Dimensiune	Pret €	Ambalare
957 0178	electromecanic		1/60



9581
Termostat electronic cu touchscreen

CARACTERISTICI TEHNICE:

- Display cu touchscreen
- Alimentare: 2 baterii AAA de 1,5 V
- Durata bateriei: 1 an
- 5 A (230 Vac)
- Functie VARA-IARNA-OFF
- Intrare digitala pentru modificarea setarii de referinta 3°C
- Domeniu de reglare: 2-50°C
- Grad de precizie: reglabil de la ± 0,1 la ± 1°C

Cod	Dimensiune	Pret €	Ambalare
957 0155	electronic		1/10



9580
Cronotermostat de ambient electronic cu touchscreen

CARACTERISTICI TEHNICE:

- Display cu touchscreen
- Alimentare: 2 baterii AAA de 1,5 V
- Durata bateriei: 1 an
- Iesire: in releu, liber de contact 5 A (230 Vac)
- Functie VARA-IARNA-OFF
- Programare saptamanala cu trei nivele de temperatura
- Domeniu de reglare: 2-50°C
- Grad de precizie: reglabil de la ± 0,1 la ± 1°C

Cod	Dimensiune	Pret €	Ambalare
957 0154	electronic		1/10



9567
Servomanda electrotermica pentru robinet termostaticabil de inchidere cu indicator de cursa.
NORMAL INCHIS

Cod	Dimensiune	Pret €	Ambalare
450 0026	24V		1/20
450 0012	230V		1/20
450 0045	24V		1/20
450 0006	230V		1/20

Versiuni cu microinterruptor auxiliar



9568
Servomotor termoelectric cu indicare cursa (pentru vane cu optiune termostatica si colector din poliamida art.3872POL - 3871PMON)

Cod	Dimensiune	Pret €	Ambalare
450 0543	24V		1/20
450 0539	230V		1/20
450 0545	24V		1/20
450 0541	230V		1/20

Versiuni cu microinterruptor auxiliar



14 TERMOSTATE SI CRONOTERMOSTATE



4625D

Distribuitoare electric cu 10 zone pentru conectarea termostatelor prin fir si a servomotoarelor electrice corespunzatoare, iesire in releu 5(2)A 230 Vac pentru comanda pompei

Cod	Dimensiune	Pret €	Ambalare
957 0005	230V		1/6

Echipat cu releu de comutare pentru comanda pompa

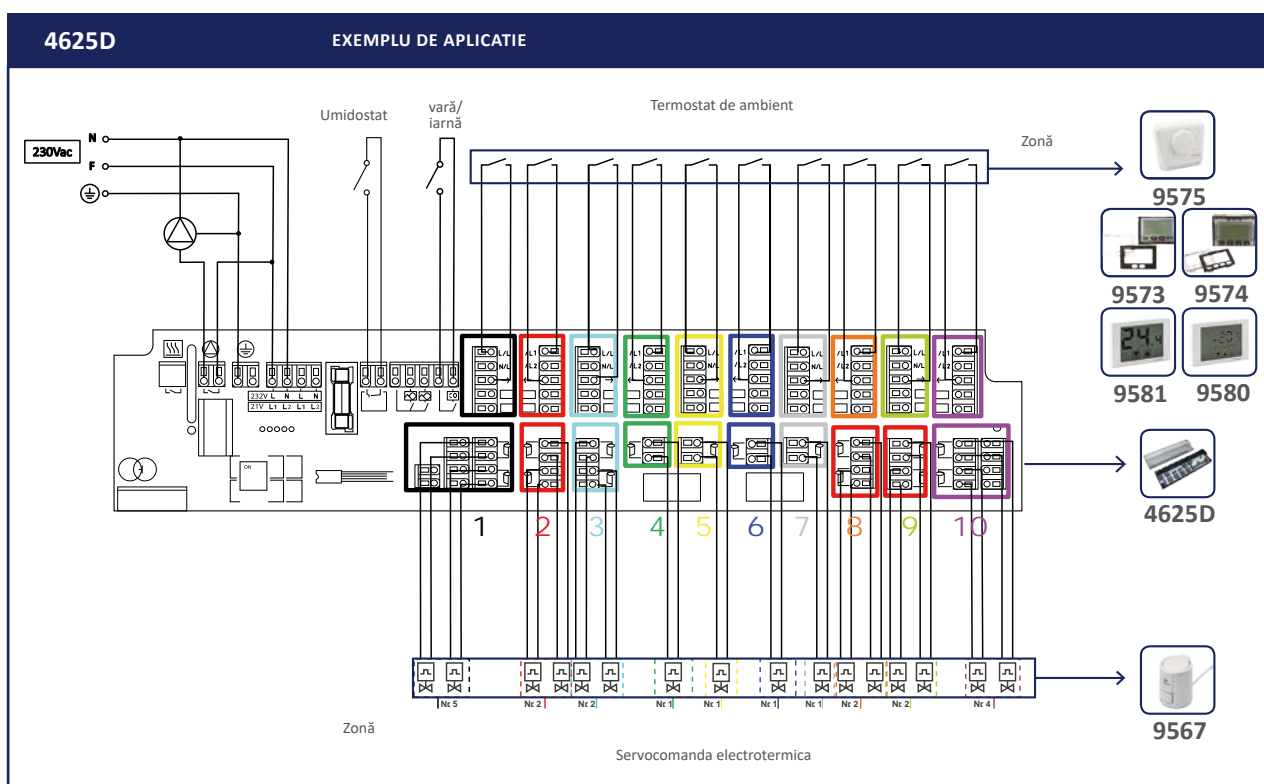



9582U

Umidostat de perete cu display cu touchscreen si alimentare de la retea electrica, pentru reglarea umiditatii in ambientul domestic

CARACTERISTICI TEHNICE:

- Alimentare: 230 Vac (-15% ÷ +10%) 50/60 Hz
- Relee de iesire monostabile 5A/250 Vac
- Tip de reglare: ON/OFF cu diferential fix ±2,5% RH
- Precizie in masurare: ± 5% RH
- Domeniu de reglare: 30% ÷ 90% RH
- Grad de protectie: IP40

Cod	Dimensiune	Pret €	Ambalare
957 0164	electronic		1/10



9583CU

Cronotermostat cu programare saptamanala, cu senzor de umiditate integrat, care regleaza temperatura si controleaza umiditatea ambientului, datorita celor doua relee independente.

CARACTERISTICI TEHNICE:

- Alimentare: 1 baterie alkalina de 1,5V (tip AA)
- Autonomie: un an
- IESIRE:
 - releu bistabil cu contact comutator 5A/ 250Vac (reglare temperatura)
 - releu normal deschis 5A/ 250Vac (reglare umiditate)
- CRONOTERMOSTAT
- Reglarea temperaturii
 - On/Off cu diferential setabil intre 0,1°C si 1°C
 - Proporzionala cu banda si perioada de reglare setate
 - Camp reglare temperatura: 2,0°C ÷ +50°C
- Functionare iarna / vara / manuala
- UMIDOSTAT

Functionia umidificare sau dezumidificare selectabila

Reglare ON/OFF cu diferential setabil intre 5% RH si 20% RH

- Precizie in masurare: ± 5% RH
- Domeniu de reglare: 30% ÷ 90% RH

Cod	Dimensiune	Pret €	Ambalare
957 0165	alba		1/6



**4601**

Termostat de ambient electronic cu transmisie via radio

CARACTERISTICI TEHNICE:

- Display cu touchscreen
- Alimentare: 2 baterii AAA de 1,5 V
- Durata bateriei: 1 an
- Frecventa de transmisie: 433,92 MHz
- Functie VARA-IARNA-OFF
- Domeniu de reglare: 2-50°C
- Grad de precizie: reglabil de la +0,1 la +1°C

Cod	Dimensiune	Pret €	Ambalare
957 0156	electronic		1/10

**9580W**

Cronotermostat de ambient electronic cu touchscreen cu transmisie via radio

CARACTERISTICI TEHNICE:

- Display cu touchscreen
- Alimentare: 2 baterii AAA de 1,5 V
- Durata bateriei: 1 an
- Frecventa de transmisie: 433,92 MHz
- Functie VARA-IARNA-OFF
- Programare saptamanala cu trei nivele de temperatura
- Domeniu de reglare: 2-50°C
- Grad de precizie: reglabil de la +0,1 la +1°C

Cod	Dimensiune	Pret €	Ambalare
957 0172	electronic		1/10

**4606**

Sistem pentru termoreglare via radio compus din termostat de ambient electronic cu touchscreen + receptor cu un canal

CARACTERISTICI TEHNICE:**TERMOSTAT**

- Vezi caracteristici tehnice art. 4601

RECEPTOR:

- Vezi caracteristici tehnice art. 4607

Cod	Dimensiune	Pret €	Ambalare
957 0157	electronic		1/4

**4607**

Receptor radio cu 1 canal cu comanda pentru centrala/pompa de caldura/pompa circulatie

CARACTERISTICI TEHNICE

- Alimentare: 230 Vac 50 Hz
- Versiune 2 module DIN
- Iesire: releu de comutare fara tensiune 8 A (230 Vac)

Cod	Dimensiune	Pret €	Ambalare
957 0183	electronic		1/25

**4612**

Receptor radio cu 6 canale cu comanda pentru capete electrotermice 9567

CARACTERISTICI TEHNICE:

- Alimentare: 230 Vac 50 Hz
- N° canale: 6
- Comanda capete electrotermice: releu de contact 5 A (230 Vac)
- Comanda pompa: releu de contact 5 A (230 Vac)
- Intarziere comanda pompa setabila de la 3 secunde la 5 minute
- Antena externa inclusa
- Versiune 4 module DIN

Cod	Dimensiune	Pret €	Ambalare
957 0158	electronic		1/4

**9556W**

Cap termostatic electronic programabil wireless. Interval de temperatura 8-28 °C

Cod	Dimensiune	Pret €	Ambalare
955 0027	M30 x 1,5		1/5

4601-4612-9567

EXEMPLU DE INSTALARE

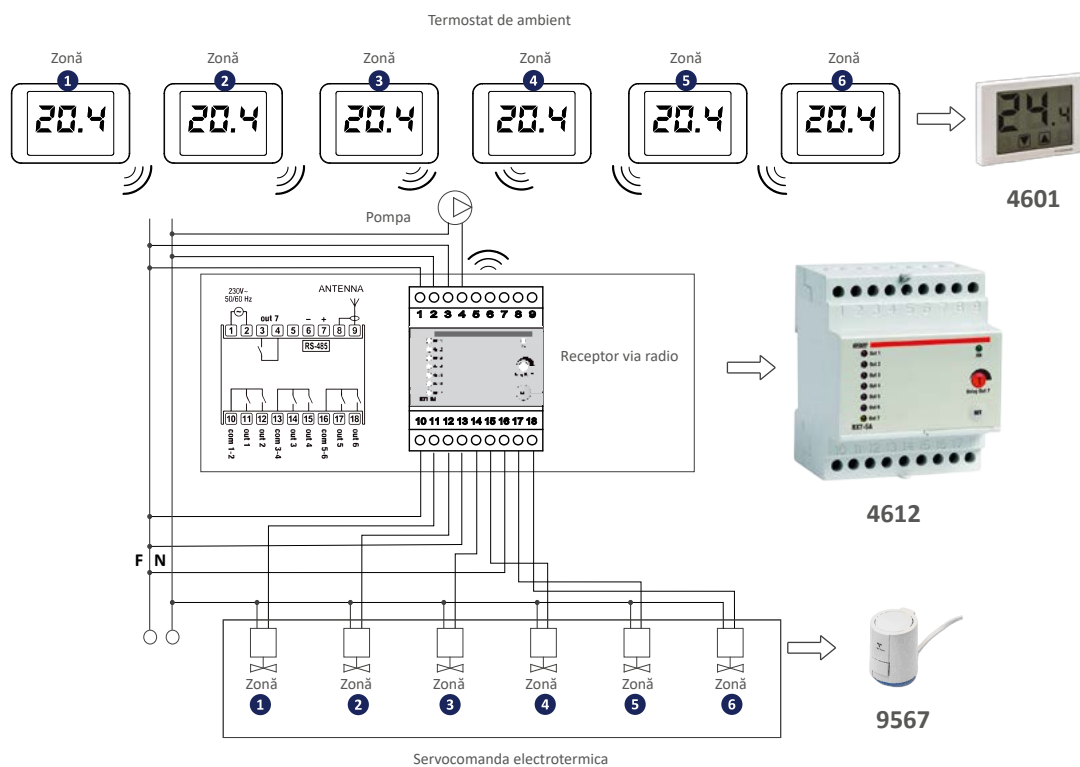

9556W-4601-9580W

EXEMPLU DE INSTALARE



14 SISTEME DE TERMOREGLARE WI-FI

TIEMME GATE

NOUȚĂȚI



9564W

Cap termostatic electronic comunicare Wi-Fi. Sistemul „TIEMME GATE”. Domeniu de temperatura 6-28o C

CARACTERISTICI TEHNICE:

- Alimentarea: nr. 2 baterii 1,5 V tip AA
- Funcționarea: ON, OFF, manuală, în regim automat
- Domeniu de reglare: +6oC÷28oC
- Tip conexiune: M30 x 1,5
- Adaptorii pentru toate tipurile de robineti uzuali prezenti pe piata
- Banda de frecvență Wi-Fi: 2,4 GHz

Cod	Dimensiune	Pret €	Ambalare
955 0052	M30 x 1,5		1/4

NOUȚĂȚI



9564ST

Sonda de temperatură cu Wi-Fi. Sistemul „TIEMME GATE”

CARACTERISTICI TEHNICE:

- Alimentarea: nr. 2 baterii 1,5 V tip AA
- Domeniu de reglare: 0 °C ÷ +50 °C
- Banda de frecvență Wi-Fi: 2,4 GHz

Cod	Dimensiune	Pret €	Ambalare
955 0053	0 °C ÷ + 50 °C		1/10

NOUȚĂȚI



9564RS

Releu cu Wi-Fi. Sistemul „TIEMME GATE”

CARACTERISTICI TEHNICE:

- Alimentarea: 85 ÷ 230 Vac 50/60 Hz
- Iesire releu de contact: 5 A 230 V
- Control tip “OpenTherm” catre centrala termica
- Banda de frecvență cu Wi-Fi: 2,4 GHz

Cod	Dimensiune	Pret €	Ambalare
955 0054	-		1/10



Disponibil pentru



9564W-9564ST-9564RS EXEMPLU DE INSTALARE

SISTEM CENTRALIZAT

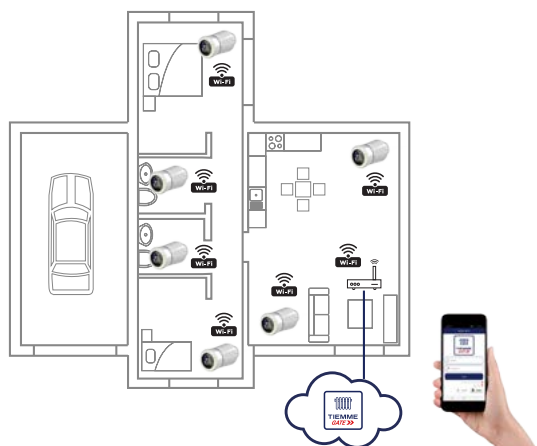

SISTEM AUTONOM

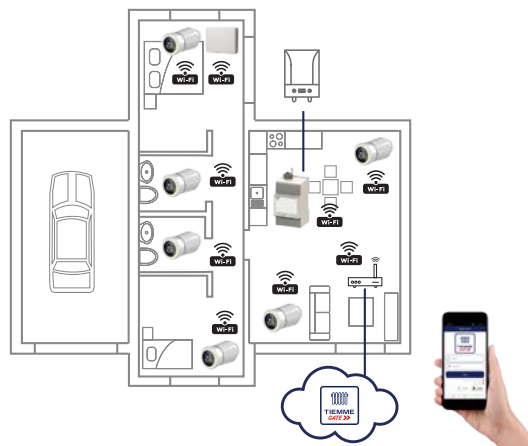



9589

Cronotermostat de perete săptămânal **TIEMME NEXT** culoare alb. Comunicare prin Wi-Fi.

CARACTERISTICI TEHNICE

- Alimentare: 230Vac ± 10% 50/60 Hz / 4 baterii de 1,5V (tip AA)
- Ieșire: releu de comutare fără tensiune de 5 A (250 Vac)
- Funcție iarnă / vara / oprit
- Programare: Săptămânal cu 3 niveluri de temperatură (T1 - T2 - T3)
- Domeniu de reglare: 2,0 ÷ 50,0 °C
- Reglarea temperaturii: ON/OFF cu diferențial reglabil (0,1 ÷ 1,0 °C) sau proporțional cu banda reglabila
- Modul Wi-Fi pentru conectarea cu aplicația TIEMME NEXT
- Montaj: Pe perete 130 x 85 grosime 28 mm

Cod	Dimensiune	Pret €	Ambalare
957 0201	230 Vac		1/10
957 0211	4 x 1,5 V AA		1/10



9590

Cronotermostat săptămânal de perete cu senzor de umiditate **TIEMME NEXT RF** de culoare albă. Comunicare prin Wi-Fi și RF (frecvență radio).

CARACTERISTICI TEHNICE

- Alimentare: 230Vac ± 10% 50/60 Hz
- Funcție iarnă / vara / oprit
- Programare: Săptămânal cu 3 niveluri de temperatură (T1 - T2 - T3)
- Domeniu de reglare: 2,0 ÷ 50,0 °C
- Reglarea temperaturii: ON / OFF cu diferențial reglabil (0,1 ÷ 1,0 °C) sau proporțional cu bandă reglabila
- Modul Wi-Fi pentru conectarea cu aplicația TIEMME NEXT
- Modul de radiofrecvență pentru gestionarea a 3 comenzi (Temperatura/Umiditate/VMC)
- Banda de frecvență: 433,92 MHz
- Montaj: Pe perete 130 x 85 grosime 28 mm

Cu senzor de umiditate

Cu modul de radiofrecvență integrat pentru comunicare cu receptorul radio art. 4607 - 4612 sau cap termostatic art. 9556W

Cod	Dimensiune	Pret €	Ambalare
957 0203	230 Vac		1/10



9591

Cronotermostat săptămânal pentru montaj încastrat (cutie dreptunghiulară) **TIEMME NEXT IN**. Comunicare Wi-Fi

CARACTERISTICI TEHNICE

- Alimentare: 230Vac ± 10% 50/60 Hz
- Ieșire: releu de comutare fără tensiune de 5 A (250 Vac)
- Funcție iarnă / vara / oprit
- Programare: Săptămânal cu 3 niveluri de temperatură (T1 - T2 - T3)
- Domeniu de reglare: 2,0 ÷ 50,0 °C
- Reglarea temperaturii: ON / OFF cu diferențial reglabil (0,1 ÷ 1,0 °C) sau proporțional cu bandă reglabila
- Modul Wi-Fi pentru conectarea cu aplicația TIEMME NEXT
- Instalare: încastrat (2 module) în seria principală casnică (Bticino, Vimar, Ave, Gewiss)

Cod	Dimensiune	Pret €	Ambalare
957 0205	230 Vac		1/5



9592

Cronotermostat săptămânal încastrat (cutie rotundă) **TIEMME NEXT RD**. Comunicare Wi-Fi

CARACTERISTICI TEHNICE

- Alimentare: 230Vac ± 10% 50/60 Hz
- Ieșire: releu de comutare fără tensiune de 5 A (250 Vac)
- Funcție iarnă / vara / oprit
- Programare: Săptămânal cu 3 niveluri de temperatură (T1 - T2 - T3)
- Domeniu de reglare: 2,0 ÷ 50,0 °C
- Reglarea temperaturii: ON / OFF cu diferențial reglabil (0,1 ÷ 1,0 °C) sau proporțional cu bandă reglabila
- Modul Wi-Fi pentru conectarea cu aplicația TIEMME NEXT
- Instalare: încastrat (distanța centrală a cutiei rotunde 60 mm)

Cod	Dimensiune	Pret €	Ambalare
957 0207	230 Vac		1/5



Disponibil pentru



LISTA DE PREȚURI



2075
Termostat cu contact reglabil

CARACTERISTICI TEHNICE

- Domeniu de reglare: 0-90°C
- Ieșire: contact liber de tensiune 16(4) A/250 Vac-6(1) A/400 Vacc
- Grad de protecție: IP40
- Diferențial: $6 \pm 2^\circ\text{C}$
- Arc de fixare inclus

Cod	Dimensiune	Pret €	Ambalare
957 0001	0/90°C		1/20



2076
Termostat de imersie reglabil

CARACTERISTICI TEHNICE

- Contine izolatia cu prindere de 1/2"
- Domeniu de reglare: 0-90°C
- Ieșire: contact liber de tensiune 16(4) A/250 Vac-6(1) A/400 Vac
- Grad de protecție: IP40
- Diferențial: $6 \pm 2^\circ\text{C}$

Cod	Dimensiune	Pret €	Ambalare
957 0003	0/90°C - 1/2"		1/10



2077
Termostat de imersie cu reglare fixa

CARACTERISTICI TEHNICE

- Inclusiv stut cu racord de 1/2"
- Temperatura de intervenție: $96 \pm 3^\circ\text{C}$
- Ieșire: contact de întrerupere 16 (2,5) A / 250 Vac
- Grad de protecție: IP40
- Diferențial: $4 \pm 2^\circ\text{C}$
- Rearmare manuală

Cod	Dimensiune	Pret €	Ambalare
957 0016	96°C - 1/2"		1/10



2078
Termostat de imersie cu actiune dubla: reglare fixa si posibilitate de reglare

CARACTERISTICI TEHNICE

- Inclusiv stut cu racord de 1/2"
- Interval de reglare: 30-90 ° C
- Temperatura de intervenție: $96 \pm 3^\circ\text{C}$
- Ieșire de reglare: contacte comutatoare fără tensiune 16 (4) A / 250 Vac
- Ieșire de calibrare fixă: contact de întrerupere 16 (2,5) A / 250 Vac
- Grad de protecție: IP40
- Diferențial: $4 \pm 2^\circ\text{C}$
- Rearmare manuală

Cod	Dimensiune	Pret €	Ambalare
957 0010	30/90°C - 96°C 1/2"		1/5

15 COMPONENTE PENTRU CENTRALE TERMICE/INCALZIRE



















INAIL



TSU

EAC



Supape de siguranta		314
Grup de siguranta		316
Manometru si termomanometru		317
Supape limitare presiune		318
Distribuitor preasamblat cu elemente de masura si control INAIL		319
Presostate și termostate de siguranță		320
Supape de siguranta pentru boiler		320
Grupuri de incarcare		321
Colectori de distributie si separatoare de otel din centrala termica		322
Colectoare de distributie din alama pentru centrala termica		323
Accesorii pentru colectoare de distributie din alama pentru centrala termica		330
Grupuri de pompare		331
Accesorii pentru grupuri de pompare		334
Filtre magnetice de separare a murdăriei		336
Dozator proportional al cristalelor de polifosfati		338
Supape de aerisire		338
Modul hidronic		341
Vana deviatie/amestec		342
Ventil termic amestec anticondens		343
Robinete de echilibrare		343
Filtre cu autocuratare		351
Filtre Y		353
Reductoare de presiune		354
Vane de amestec termostactice		356
Kit termostatic anti-oparire cu recirculare		357
Amortizor lovitura de berbec		358
Vana anti-retur		359



**1917
1927**
Supapa de siguranta F/F

CARACTERISTICI TEHNICE:

- Temperatura minima de exercitiu: -5°C
- Temperatura maxima de exercitiu: 120°C
- Presiune nominala: PN10
- Corp: din alama CW 617N
- Marja de deschidere: 10%
- Filete interioare: F ISO 228

Cod	Dimensiune	Tarare	Pret €	Ambalare
192 0013	1/2" x 1/2"	1,5 bar		1/40
192 0033	1/2" x 1/2"	1,8 bar		1/40
192 0025	1/2" x 1/2"	2 bar		1/40
192 0008	1/2" x 1/2"	2,5 bar		1/40
192 0001	1/2" x 1/2"	3 bar		1/40
192 0060	1/2" x 1/2"	3,5 bar		1/40
192 0010	1/2" x 1/2"	4 bar		1/40
192 0053	1/2" x 1/2"	5 bar		1/40
192 0006	1/2" x 1/2"	6 bar		1/40
192 0022	1/2" x 1/2"	7 bar		1/40
192 0035	1/2" x 1/2"	8 bar		1/40
192 0011	1/2" x 1/2"	9 bar		1/40
192 0018	1/2" x 1/2"	10 bar		1/40
192 0014	3/4" x 3/4"	1,5 bar		1/40
192 0027	3/4" x 3/4"	1,8 bar		1/40
192 0034	3/4" x 3/4"	2 bar		1/40
192 0012	3/4" x 3/4"	2,5 bar		1/40
192 0003	3/4" x 3/4"	3 bar		1/40
192 0054	3/4" x 3/4"	3,5 bar		1/40
192 0015	3/4" x 3/4"	4 bar		1/40
192 0071	3/4" x 3/4"	5 bar		1/40
192 0007	3/4" x 3/4"	6 bar		1/40
192 0036	3/4" x 3/4"	7 bar		1/40
192 0030	3/4" x 3/4"	8 bar		1/40
192 0043	3/4" x 3/4"	9 bar		1/40
192 0031	3/4" x 3/4"	10 bar		1/40
192 0072	1" x 1"	1,5 bar		1/25
192 0073	1" x 1"	1,8 bar		1/25
192 0074	1" x 1"	2 bar		1/25
192 0075	1" x 1"	2,5 bar		1/25
192 0004	1" x 1"	3 bar		1/25
192 0076	1" x 1"	3,5 bar		1/25

1917-1927 - Supapa de siguranta F/F

Cod	Dimensiune	Tarare	Pret €	Ambalare
192 0023	1" x 1"	4 bar		1/25
192 0077	1" x 1"	5 bar		1/25
192 0009	1" x 1"	6 bar		1/25
192 0016	1" x 1"	7 bar		1/25
192 0026	1" x 1"	8 bar		1/25



**1918
1928**
Supapa de siguranta M/F

CARACTERISTICI TEHNICE:

- Temperatura minima de exercitiu: -5°C
- Temperatura maxima de exercitiu: 120°C
- Presiune nominala: PN10
- Corp: din alama CW 617N
- Marja de deschidere: 10%
- Filete interioare: F ISO 228

Cod	Dimensiune	Tarare	Pret €	Ambalare
192 0052	1/2" x 1/2"	1,5 bar		1/40
192 0078	1/2" x 1/2"	1,8 bar		1/40
192 0045	1/2" x 1/2"	2 bar		1/40
192 0041	1/2" x 1/2"	2,5 bar		1/40
192 0002	1/2" x 1/2"	3 bar		1/40
192 0055	1/2" x 1/2"	3,5 bar		1/40
192 0020	1/2" x 1/2"	4 bar		1/40
192 0059	1/2" x 1/2"	5 bar		1/40
192 0005	1/2" x 1/2"	6 bar		1/40
192 0029	1/2" x 1/2"	7 bar		1/40
192 0037	1/2" x 1/2"	8 bar		1/40
192 0050	1/2" x 1/2"	9 bar		1/40
192 0038	1/2" x 1/2"	10 bar		1/40
192 0086	1" x 1"	1,5 bar		1/25
192 0087	1" x 1"	1,8 bar		1/25
192 0088	1" x 1"	2 bar		1/25
192 0089	1" x 1"	2,5 bar		1/25
192 0090	1" x 1"	3 bar		1/25
192 0091	1" x 1"	3,5 bar		1/25
192 0092	1" x 1"	4 bar		1/25
192 0093	1" x 1"	5 bar		1/25
192 0102	1" x 1"	6 bar		1/25
192 0019	1" x 1"	7 bar		1/25
192 0024	1" x 1"	8 bar		1/25





1917M 1927M

Supapa de siguranta F/F ISO 7

CARACTERISTICI TEHNICE:

- Temperatura minima de exercitiu: -5°C
- Temperatura maxima de exercitiu: 120°C
- Presiune nominala: PN10
- Corp: din alama CW 617N
- Marja de deschidere: 10%
- Filete interioare: F ISO 7

+ IESIRE MARITA

Cod	Dimensiune	Tarare	Pret €	Ambalare
192 0066	1/2" x 3/4"	1,5 bar		1/40
192 0067	1/2" x 3/4"	1,8 bar		1/40
192 0048	1/2" x 3/4"	2 bar		1/40
192 0042	1/2" x 3/4"	2,5 bar		1/40
192 0040	1/2" x 3/4"	3 bar		1/40
192 0068	1/2" x 3/4"	3,5 bar		1/40
192 0069	1/2" x 3/4"	4 bar		1/40
192 0070	1/2" x 3/4"	5 bar		1/40
192 0039	1/2" x 3/4"	6 bar		1/40
192 0057	1/2" x 3/4"	7 bar		1/40
192 0096	1/2" x 3/4"	8 bar		1/40
192 0097	1/2" x 3/4"	9 bar		1/40
192 0098	1/2" x 3/4"	10 bar		1/40



1917MAN 1927MAN

Supapa de siguranta F/F cu iesire manometru

CARACTERISTICI TEHNICE:

- Temperatura minima de exercitiu: -5°C
- Temperatura maxima de exercitiu: 120°C
- Presiune nominala: PN10
- Corp: din alama CW 617N
- Marja de deschidere: 10%
- Filete interioare: F ISO 228

+ CU RACORD MANOMETRU

i Accesorii: Termometru art. 2080POST pag.317

Cod	Dimensiune	Tarare	Pret €	Ambalare
192 0061	1/2" x 1/2"	1,5 bar		1/40
192 0062	1/2" x 1/2"	1,8 bar		1/40
192 0063	1/2" x 1/2"	2 bar		1/40
192 0046	1/2" x 1/2"	2,5 bar		1/40
192 0028	1/2" x 1/2"	3 bar		1/40
192 0064	1/2" x 1/2"	3,5 bar		1/40
192 0044	1/2" x 1/2"	4 bar		1/40
192 0065	1/2" x 1/2"	5 bar		1/40
192 0058	1/2" x 1/2"	6 bar		1/40
192 0051	1/2" x 1/2"	7 bar		1/40
192 0094	1/2" x 1/2"	8 bar		1/40
192 0095	1/2" x 1/2"	9 bar		1/40
192 0056	1/2" x 1/2"	10 bar		1/40



**1918MAN
1928MAN**
Supapa de siguranta M/F cu
iesire manometru

CARACTERISTICI TEHNICE:

- Temperatura minima de exercitiu: -5°C
- Temperatura maxima de exercitiu: 120°C
- Presiune nominala: PN10
- Corp: din alama CW 617N
- Marja de deschidere: 10%
- Filete interioare: F ISO 228

CU RACORD MANOMETRU

Accesorii: Manometru art. 2080POST pag. 317

Cod	Dimensiune	Tarare	Pret €	Ambalare
192 0079	1/2" x 1/2"	1,5 bar		1/40
192 0080	1/2" x 1/2"	1,8 bar		1/40
192 0081	1/2" x 1/2"	2 bar		1/40
192 0082	1/2" x 1/2"	2,5 bar		1/40
192 0032	1/2" x 1/2"	3 bar		1/40
192 0083	1/2" x 1/2"	3,5 bar		1/40
192 0084	1/2" x 1/2"	4 bar		1/40
192 0085	1/2" x 1/2"	5 bar		1/40
192 0049	1/2" x 1/2"	6 bar		1/40
192 0047	1/2" x 1/2"	7 bar		1/40
192 0099	1/2" x 1/2"	8 bar		1/40
192 0100	1/2" x 1/2"	9 bar		1/40
192 0101	1/2" x 1/2"	10 bar		1/40



1916
Supapa de siguranta M de
temperatura si presiune pentru
teava cupru

CARACTERISTICI TEHNICE:

- Temperatura de exercitiu: între 90 și 95°C
- Presiune de exercitiu: 3-4-6-7 bar
- Presiune nominala PN 10
- Fluid: apa
- Material corp: alama CW 617N UNI EN 12165
- Conform Normei europene EN 1490 si Directivei 97/23/CE (PED)

CONTROL TEMPERATURA-PRESIUNE

Cod	Dimensiune	Tarare	Pret €	Ambalare
192 0106	1/2" x 15	3 bar		1/10
192 0107	1/2" x 15	4 bar		1/10
192 0108	1/2" x 15	6 bar		1/10
192 0109	1/2" x 15	7 bar		1/10
192 0111	3/4" x 15	3 bar		1/10
192 0112	3/4" x 15	4 bar		1/10
192 0113	3/4" x 15	6 bar		1/10
192 0114	3/4" x 15	7 bar		1/10
192 0116	3/4" x 22	3 bar		1/10
192 0117	3/4" x 22	4 bar		1/10
192 0118	3/4" x 22	6 bar		1/10
192 0119	3/4" x 22	7 bar		1/10

Pentru încălzitorul de apă

NOUȚATI



**3177
3177X**
Grup de siguranta pentru boiler
si acumulator acm

Cod	Dimensiune	Tarare	Pret €	Ambalare
319 0013	3/4" x 3/4"	7 bar		1/20
319 0014	3/4" x 3/4"	7 bar		1/20

Scaun (supapă de siguranță) alamă

Scaun (supapă de siguranță) din oțel inoxidabil



15 GRUP DE SIGURANTA

Pentru centrale (cazane) pe lemne



3175CT
Grup de siguranta izolat pt. centrale pe lemne

Cod	Dimensiune	Pret €	Ambalare
319 0010	1" - 1,5 bar		1/5
319 0021	1" - 2,5 bar		1/5
319 0009	1" - 3 bar		1/5

Noutati

TUTORIAL VIDEO



Grup de siguranta cu izolatie pentru cazane pe lemne - Principiu de functionare



3175ISOL
Grup de siguranta izolat pentru centrale pe lemne

Cod	Dimensiune	Pret €	Ambalare
319 0003	1" - 1,5 bar		1/5
319 0001	1" - 3 bar		1/5

15 MANOMETRU SI TERMOMANOMETRU



2080POST
Manometru cu atac posterior



Cod	Dimensiune	Scara	Pret €	Ambalare
192 0021	1/4"	0 - 4 bar		1/40
192 0017	1/4"	0 - 10 bar		1/40

Pentru supape tarate pana la 3 bar



2080
Manometru cu prindere radiala DN50

Cod	Dimensiune	Scara	Pret €	Ambalare
318 0007	1/4"	0 - 6 bar		5/25
318 0025	1/4"	0 - 16 bar		5/25



2081
Termomanometru 0-120°C/0-6 bar

Cod	Dimensiune	Pret €	Ambalare
208 0001	1/4" (1/2")		1/30



19210M

Supapa limitare presiune unghiulara cu racord cu filet interior/interior si evacuare directionata, care poate fi calibrata la 0÷16 bar, cu obturator din metal

CARACTERISTICI TEHNICE:

- Temperatura minima de exercitiu: 5°C
- Temperatura maxima de exercitiu: 200°C
- Presiune nominala: PN16 (de 3/8" a 2")- PN10 (de 2"½ a 3")
- Corp: CW 617N brass
- Marja de deschidere: 20%
- Filete interioare: F ISO 228

Cod	Dimensiune	Pret €	Ambalare
196 0001	3/8"		12/48
196 0002	1/2"		10/40
196 0003	3/4"		7/28
196 0004	1"		4/16
196 0005	1"1/4		2/8
196 0006	1"1/2		1/4
196 0007	2"		1/4
196 0008	2"1/2		1/1
196 0009	3"		1/1



19210G

Supapa limitare presiune unghiulara cu racord cu filet interior/interior si evacuare directionata, care poate fi calibrata la 0÷16 bar, cu obturator din cauciuc (SBR)

CARACTERISTICI TEHNICE:

- Temperatura minima de exercitiu: 5°C
- Temperatura maxima de exercitiu: 70°C
- Presiune nominala: PN16 (de 3/8" a 2")- PN10 (de 2"½ a 3")
- Corp: CW 617N brass
- Marja de deschidere: 20%
- Filete interioare: F ISO 228

Cod	Dimensiune	Pret €	Ambalare
196 0019	3/8"		12/48
196 0020	1/2"		10/40
196 0021	3/4"		7/28
196 0022	1"		4/16
196 0023	1"1/4		2/8
196 0024	1"1/2		1/4
196 0025	2"		1/4
196 0026	2"1/2		1/1
196 0027	3"		1/1



19210P

Supapa limitare presiune unghiulara cu racord cu filet interior/interior si evacuare directionata, care poate fi calibrata la 0÷16 bar, cu obturator din PTFE

CARACTERISTICI TEHNICE:

- Temperatura minima de exercitiu: 5°C
- Temperatura maxima de exercitiu: 180°C
- Presiune nominala: PN16 (de 3/8" a 2")- PN10 (de 2"½ a 3")
- Corp: CW 617N brass
- Marja de deschidere: 20%
- Filete interioare: F ISO 228

Cod	Dimensiune	Pret €	Ambalare
196 0037	3/8"		12/48
196 0038	1/2"		10/40
196 0039	3/4"		7/28
196 0040	1"		4/16
196 0041	1"1/4		2/8
196 0042	1"1/2		1/4
196 0043	2"		1/4
196 0044	2"1/2		1/1
196 0045	3"		1/1



LISTA DE PRETURI

**7169**

Distribuitor cu preasamblat cu elemente de masura si control

CARACTERISTICI TEHNICE:

- Corp colector: oțel ST195 vopsit
- Racorduri principale: filetat cu olandezi 1"1/4, 1"1/2, 2" și flansa (PN16) DN50, DN65 și DN80
- Fluid utilizat: apă și glicol (procentaj maxim 30%)
- Pmax de exercitiu: 10 bar
- Gama de temperatura: 0 ÷ 110°C

Cod	Dimensiune	Pret €	Ambalare
321 0001	1"1/4		1/1
321 0002	1"1/2		1/1
321 0003	2"		1/1
321 0004	DN50		1/1
321 0005	DN65		1/1
321 0006	DN80		1/1

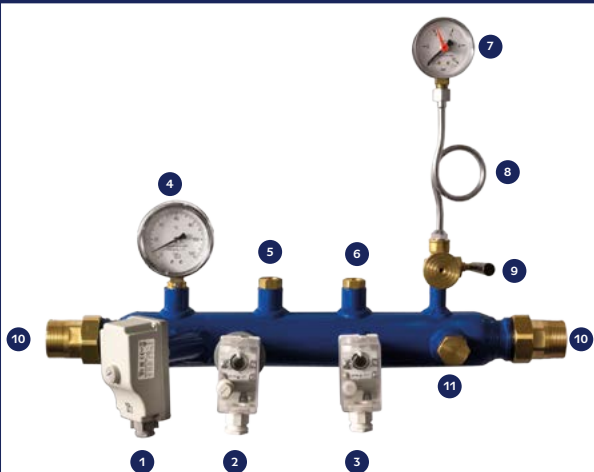
7169**CONFIGURATIE**

1. Termostat de imersie
2. Presostat de siguranta cu re-armare manula
3. Presostat de minim cu re-armare manuala
4. Termometru
5. Stut pentru vana de control a alimentarii cu combustibil
6. Stut pentru control
7. Manometru
8. Sifon de amortizare pentru temperaturi inalte
9. Robinet pentru manometru
10. Racorduri
11. Racord disponibil pentru conectarea supapei de siguranta INAIL

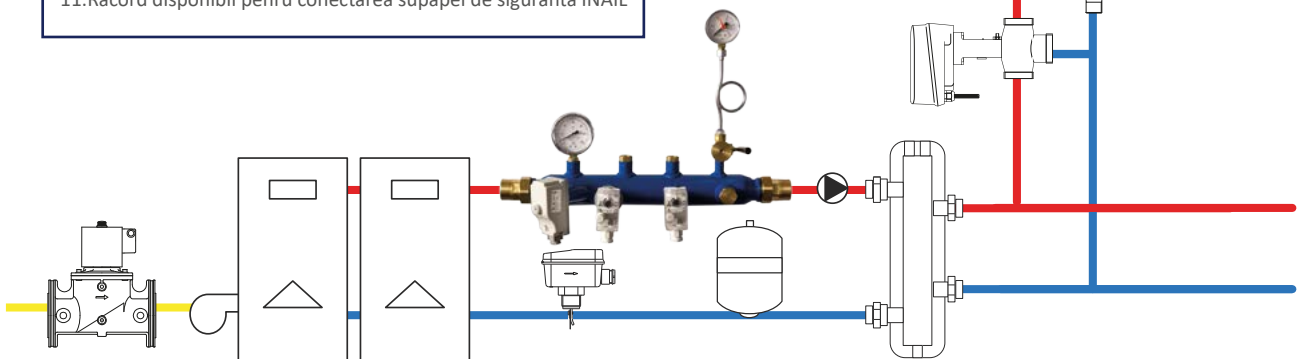
**1923**

Robinet pentru manometru cu racord cu filet exterior/interior cu presetupa și dren. Mâner din rasina termoplastica

Cod	Dimensiune	Pret €	Ambalare
199 0007	1/4"		15/60
199 0008	3/8"		10/40
199 0009	1/2"		5/20

**1923FL**

Robinet pentru manometru cu racord cu filet exterior/interior cu blocare de siguranta, flansa și capac flansa. Mâner din rasina termoplastica

Cod	Dimensiune	Pret €	Ambalare
199 0001	1/4"		15/60
199 0002	3/8"		10/40
199 0003	1/2"		5/20

**1924**

Serpentina pentru manometru cu racord cu filet exterior fix, capac rotativ și teava de cupru Ø 8 mm

Cod	Dimensiune	Pret €	Ambalare
178 0001	1/4"		10/40
178 0002	3/8"		10/40
178 0003	1/2"		10/40

**2074MIN**

Comutator al presiunii minime
cu resetare manuala, IP44

Cod	Dimensiune	Pret €	Ambalare
075 0069	0,5 ÷ 2,5 Bar		1/18

**2074MAX**

Comutator al presiunii maxime
cu resetare manuala, IP44

Cod	Dimensiune	Pret €	Ambalare
075 0068	2 ÷ 5,5 Bar		1/18

**2079**

Presostat pentru instalatii
hidro-sanitare

Cod	Dimensiune	Pret €	Ambalare
075 0022	1 - 5 Bar		1/50
075 0041	3 - 12 Bar		1/15

**2079-3V**

Presostat monofazat Racord cu 3
căi Manometru apă

Cod	Dimensiune	Pret €	Ambalare
075 0001	1 - 5 Bar		1/30

**2079INV**

Presostat de protectie inversa
pentru sisteme hidraulice si
pneumatice

Cod	Dimensiune	Pret €	Ambalare
075 0070	1 - 5 Bar		1/50

**1919**

Supapa de siguranta pentru
boiler

CARACTERISTICI TEHNICE:

- Temperatura maxima de exercitiu: 120°C
- Presiune nominala: PN10
- Corp: din alama CW 617N
- Filete interioare: M/F ISO 228

Cod	Dimensiune	Taratura	Pret €	Ambalare
193 0002	1/2"	8,5 bar		5/50

**1929**

Supapa de siguranta pentru
boiler cu "maneta"

CARACTERISTICI TEHNICE:

- Temperatura maxima de exercitiu: 120°C
- Presiune nominala: PN10
- Corp: din alama CW 617N
- Filete interioare: M/F ISO 228

Cod	Dimensiune	Taratura	Pret €	Ambalare
193 0001	1/2"	8,5 bar		5/50





3160GN
Grup de incarcare automat

CARACTERISTICI TEHNICE:

- Domeniu de reglare: 1-6 bar (Setare din fabrică 1,5 bar)
- Presiune maxima in amonte: 16 bar
- Temperatura maxima de exercitiu: 65°C
- Corp: din alama CW 617N
- Intrare: olandez 1/2" M ISO 228
- Iesire: 1/2" F ISO 228
- Iesire manometru: 1/4" F
- Livrat cu manometru

Cod	Dimensiune	Pret €	Ambalare
317 0030	1/2"		1/10



3161
Grup de incarcare automat cu 2 robineti de izolare si manometru pentru instalatiile de incalzire cu circuit inchis

CARACTERISTICI TEHNICE:

- Interval de reglare: 1-6 bar (setare din fabrică 1,5 bar)
- Presiune maximă de intrare: 16 bar
- Temperatura maxima de lucru: 65°C
- Material corp: alama CW617N
- Racord manometru: 1/4" F
- Se livreaza cu manometru

Cod	Dimensiune	Pret €	Ambalare
317 0007	1/2"		1/8
317 0008	3/4"		1/8



3180C
Cartus de înlocuire pentru reductor de presiune Art. 3180 si grup de incarcare automat Art. 3160GN - 3161

Cod	Dimensiune	Pret €	Ambalare
318 0053	3180/ 3160GN/3161		1/40



3170
Grup de alimentare cu antigel

CARACTERISTICI TEHNICE:

- Temperatura minima de exercitiu: -20°C
- Temperatura maxima de exercitiu: +100°C
- Presiune maxima de exercitiu: 10 bar
- Corp: din alama CW 617N
- Legaturi linie principala: 1" M ISO 228
- Legaturi pentru antigel: 3/4" M ISO 228
- Contine filtre de 350 µm
- Livrat cu izolatie in polistiren expandat (EPS)

Cod	Dimensiune	Pret €	Ambalare
317 0002	1"		1/2

3170 FUNCTIONARE

FUNCTIONARE NORMALA

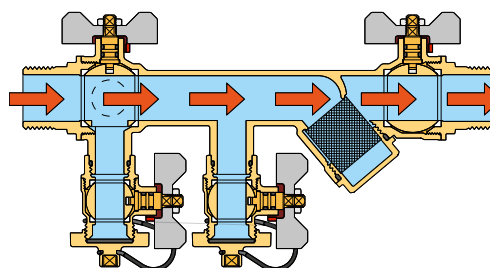

FUNCTIONARE IN CONTINUU

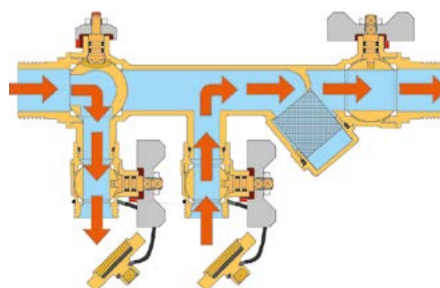

**3165**

Butelie de egalizare

CARACTERISTICI TEHNICE:

- Material corp: oțel Fe 360 vopsit cu pulberi epoxidice
- Presiune maximă de lucru: 10 bar
- Temperatura maxima de lucru: 110°C

i Transformabil in varianta magnetica cu ajutorul accesoriului 3144MAG

Cod	Dimensiune	Debit max	Pret €	Ambalare
316 0006	1"	2,5 (m³/h)		1/1
316 0003	1"1/4	4,0 (m³/h)		1/1
316 0004	1"1/2	6,0 (m³/h)		1/1
316 0005	2"	9,0 (m³/h)		1/1

**3165ISOL**

Butelie de egalizare cu izolație în polistiren expandat

CARACTERISTICI TEHNICE:

- Material corp: oțel Fe 360 vopsit cu pulberi epoxidice
- Material izolație: PE-X expandat cu celule închise
- Presiune maximă de lucru: 10 bar
- Temperatura maxima de lucru: 100°C

i Transformabil in varianta magnetica cu ajutorul accesoriului 3144MAG.

Cod	Dimensiune	Debit max	Pret €	Ambalare
316 0001	1"	2,5 (m³/h)		1/1
316 0002	1"1/4	4,0 (m³/h)		1/1
316 0008	1"1/2	6,0 (m³/h)		1/1
316 0007	2"	9,0 (m³/h)		1/1

**3144**

Butelie de egalizare echipata cu kit magnetic

**CARACTERISTICI TEHNICE:**

- Material corp: oțel Fe 360 vopsit cu pulberi epoxidice
- Presiune maximă de lucru: 10 bar
- Temperatura maxima de lucru: 110°C

Cod	Dimensiune	Debit max	Pret €	Ambalare
314 0001	1"	2,5 (m³/h)		1/1
314 0002	1"1/4	4,0 (m³/h)		1/1
314 0003	1"1/2	6,0 (m³/h)		1/1
314 0004	2"	9,0 (m³/h)		1/1

**3144ISOL**

Butelie de egalizare echipata cu kit magnetic și izolație polistiren expandat

**CARACTERISTICI TEHNICE:**

- Material corp: oțel Fe 360 vopsit cu pulberi epoxidice
- Material izolație: PE-X expandat cu celule închise
- Presiune maximă de lucru: 10 bar
- Temperatura maxima de lucru: 100°C

Cod	Dimensiune	Debit max	Pret €	Ambalare
314 0005	1"	2,5 (m³/h)		1/1
314 0006	1"1/4	4,0 (m³/h)		1/1
314 0007	1"1/2	6,0 (m³/h)		1/1
314 0008	2"	9,0 (m³/h)		1/1

**3165 - 3165ISOL
3144 - 3144ISOL**

EXEMPLU DE INSTALARE

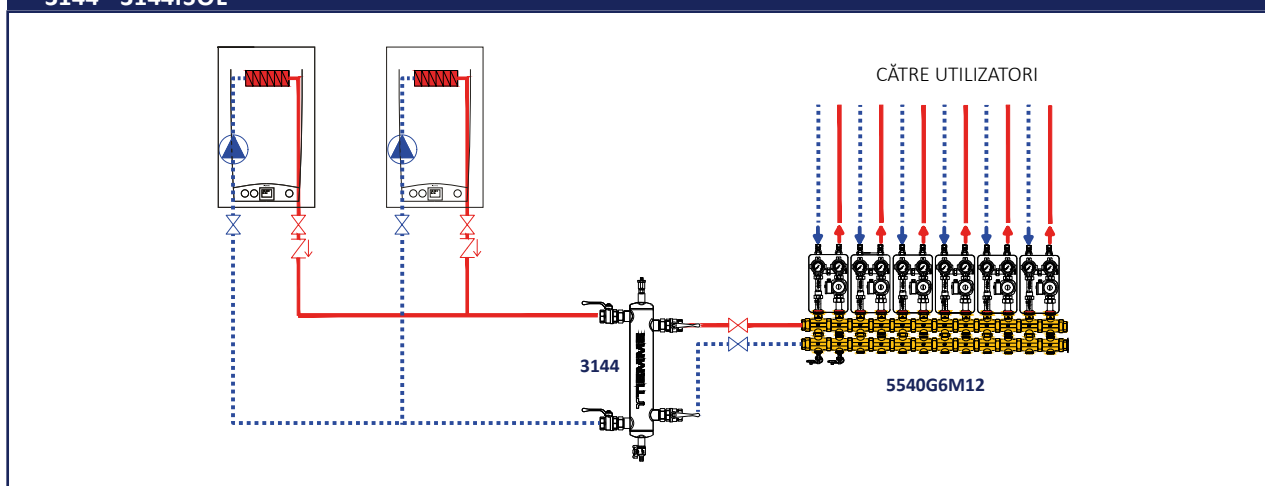

**3144MAG**

Kit magnetic



Cod	Dimensiune	Pret €	Ambalare
316 0105	1/2"		1/25

**3167ISOL**

Butelie de egalizare cu flanse si izolatie

CARACTERISTICI TEHNICE

- Material corp: oțel Fe 360
- Material izolator: PPE
- Presiune maximă de lucru: 10 bar
- Temperatura maxima de lucru: 100°C

Cod	Dimensiune	Debit max	Pret €	Ambalare
316 0106	DN50	9 (m³/h)		1/1
316 0107	DN65	20 (m³/h)		1/1
316 0108	DN80	25 (m³/h)		1/1
316 0109	DN100	40 (m³/h)		1/1
316 0110	DN125	65 (m³/h)		1/1
316 0111	DN150	95 (m³/h)		1/1

Prevazut cu baza suport pentru podea

**5539X**

Compensator hidraulic (butelie de egalizare)/colector din oțel cu izolatie si seturi de prindere, interaxa 125 mm, racorduri cu garnitura plata si semiolandez 1"1/2

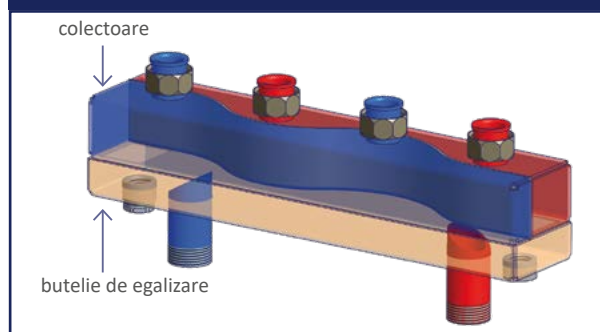

Cod	Dimens.	Nr. circuite	Debit max	Pret €	Ambalare
557 0001	80 x 80	2	3,0 (m³/h)		1/1
557 0002	80 x 80	3	3,0 (m³/h)		1/1
557 0003	120 x 120	2	7,0 (m³/h)		1/1
557 0004	120 x 120	3	7,0 (m³/h)		1/1
557 0005	120 x 120	4	7,0 (m³/h)		1/1

5539X**FUNCTIONARE****5538X
5540X**

Colector din oțel cu izolatie si seturi de prindere, interaxa 125 mm, racorduri cu garnitura plata si semiolandez 1"1/2



Cod	Dimens.	Nr. circuite	Debit max	Pret €	Ambalare
557 0006	80 x 60	2	3,0 (m³/h)		1/1
557 0007	80 x 60	3	3,0 (m³/h)		1/1
557 0008	120 x 80	3	6,5 (m³/h)		1/1
557 0009	120 x 80	4	6,5 (m³/h)		1/1
557 0010	120 x 80	5	6,5 (m³/h)		1/1
557 0366	120 x 80	6	6,5 (m³/h)		1/1

**5540X**

Set suporti pentru pardoseala izolati fonic si zincati

i Accesorii pentru colector de 120x80

Cod	Dimensiune	Pret €	Ambalare
557 0011	h= 405-600 mm		1/1

**7166**

Separator hidraulic cu filet si izolatie

Cod	Dimens.	Debit max	Pret €	Ambalare
316 0050	1"	2,5 (m³/h)		1/1

**7167**

Separator hidraulic cu filet, izolatie si supape

Cod	Dimens.	Debit max	Pret €	Ambalare
316 0065	1"	2,5 (m³/h)		1/1

7166 - 7167

EXEMPLE DE INSTALARE

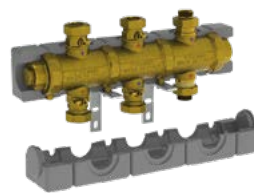
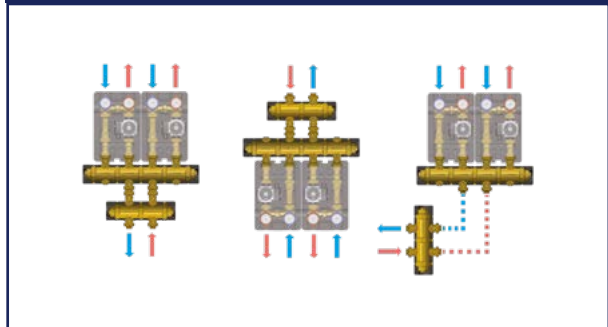
**5538G2M3**

Colector modular din alama pentru centrala termica cu robineti cu sfera, izolatie si cleme de fixare. Interaxa 125 mm, racorduri cu fata plana si piulita de 1"1/2

Cod	Dimens.	Nr. circuite	Debit max	Pret €	Ambalare
557 0368	2"1/2	2	2,2 (m³/h)		1/1
557 0483	2" 1/2	2	2,2 (m³/h)		1/1

5538G2M3

EXEMPLE DE INSTALARE

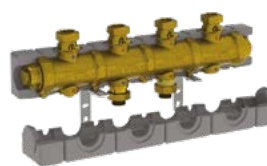
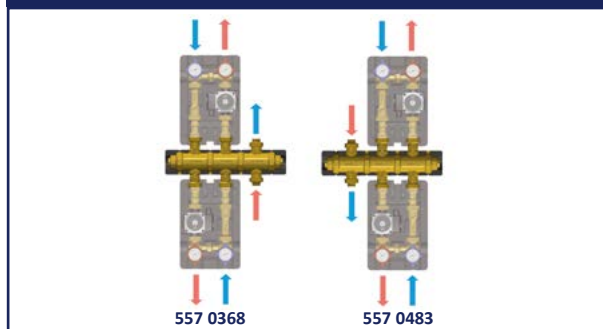
**5538G2M4**

Colector modular din alama pentru centrala termica cu robineti cu sfera, izolatie si cleme de fixare. Interaxa 125 mm, racorduri cu fata plana si piulita de 1"1/2

Cod	Dimens.	Nr. circuite	Debit max	Pret €	Ambalare
557 0369	2"1/2	2	2,2 (m³/h)		1/1
557 0484	2" 1/2	2	2,2 (m³/h)		1/1
557 0485	2" 1/2	2	2,2 (m³/h)		1/1

5538G2M4

EXEMPLE DE INSTALARE

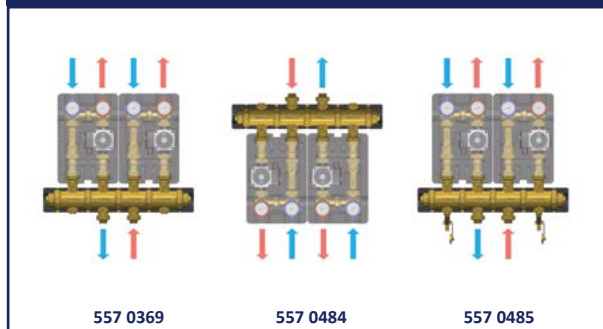

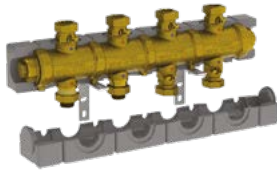
**5538G3M4**

Colector modular din alama pentru centrala termica cu robineti cu sfera, izolatie si cleme de fixare. Interaxa 125 mm, racorduri cu fata plana si piulita de 1"1/2

Cod	Dimens.	Nr. circuite	Debit max	Pret €	Ambalare
557 0370	2"1/2	3	2,2 (m ³ /h)		1/1
557 0486	2" 1/2	3	2,2 (m ³ /h)		1/1

5538G3M4

EXEMPLE DE INSTALARE

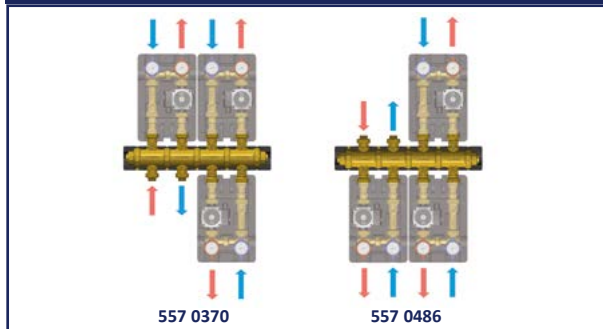

557 0370

557 0486

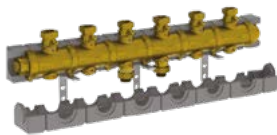
**5538G3M6**

Colector modular din alama pentru centrala termica cu robineti cu sfera, izolatie si cleme de fixare. Interaxa 125 mm, racorduri cu fata plana si piulita de 1"1/2

Cod	Dimens.	Nr. circuite	Debit max	Pret €	Ambalare
557 0371	2"1/2	3	2,2 (m ³ /h)		1/1
557 0487	2" 1/2	3	2,2 (m ³ /h)		1/1
557 0488	2" 1/2	3	2,2 (m ³ /h)		1/1

5538G3M6

EXEMPLE DE INSTALARE

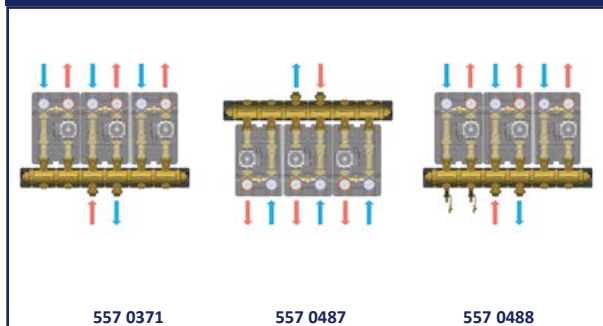

557 0371

557 0487

557 0488

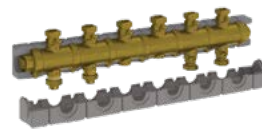
**5538G4M6**

Colector modular din alama pentru centrala termica cu robineti cu sfera, izolatie si cleme de fixare. Interaxa 125 mm, racorduri cu fata plana si piulita de 1"1/2

Cod	Dimens.	Nr. circuite	Debit max	Pret €	Ambalare
557 0477	2"1/2	4	2,2 (m ³ /h)		1/1
557 0478	2" 1/2	4	2,2 (m ³ /h)		1/1
557 0479	2" 1/2	4	2,2 (m ³ /h)		1/1

5538G4M6

EXEMPLE DE INSTALARE

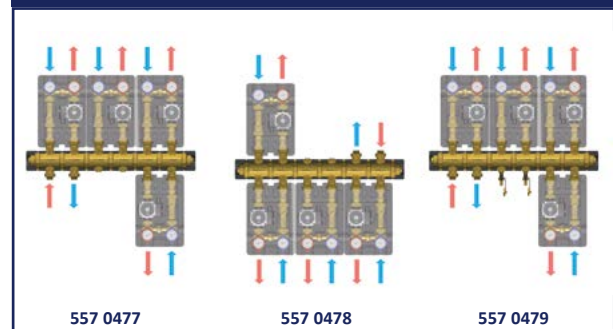

557 0477

557 0478

557 0479

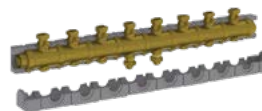
**5538G4M8**

Colector modular din alama pentru centrala termica cu robineti cu sfera, izolatie si cleme de fixare. Interaxa 125 mm, racorduri cu fata plana si piulita de 1"1/2

Cod	Dimens.	Nr. circuite	Debit max	Pret €	Ambalare
557 0480	2"1/2	4	2,2 (m ³ /h)		1/1
557 0481	2" 1/2	4	2,2 (m ³ /h)		1/1
557 0482	2" 1/2	4	2,2 (m ³ /h)		1/1

5538G4M8

EXEMPLE DE INSTALARE

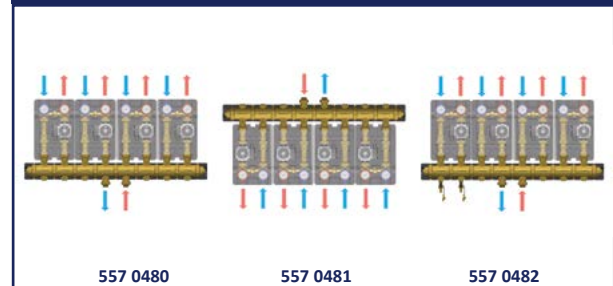

557 0480

557 0481

557 0482

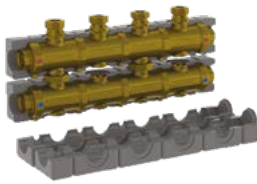
**5540G2M4**

Colector modular din alama pentru centrala termica cu robineti cu sfera, izolatie si cleme de fixare. Interaxa 125 mm, racorduri cu fata plana si piulita de 1"1/2

Cod	Dimens.	Nr. circuite	Debit max	Pret €	Ambalare
557 0372	2"1/2	2	6,5 (m³/h)		1/1
557 0489	2"1/2	2	6,5 (m³/h)		1/1
557 0490	2"1/2	2	6,5 (m³/h)		1/1

5540G2M4

EXEMPLE DE INSTALARE

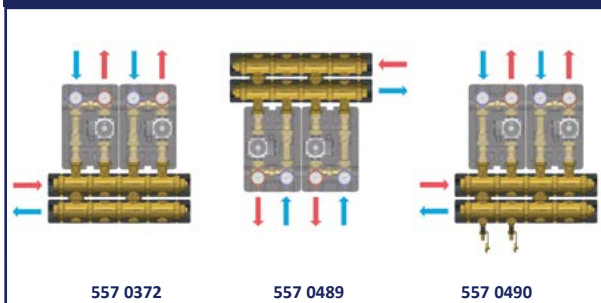

557 0372

557 0489

557 0490

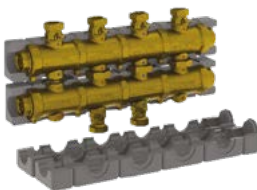
**5540G3M4**

Colector modular din alama pentru centrala termica cu robineti cu sfera, izolatie si cleme de fixare. Interaxa 125 mm, racorduri cu fata plana si piulita de 1"1/2

Cod	Dimens.	Nr. circuite	Debit max	Pret €	Ambalare
557 0373	2"1/2	3	6,5 (m³/h)		1/1
557 0491	2"1/2	3	6,5 (m³/h)		1/1
557 0492	2"1/2	3	6,5 (m³/h)		1/1

5540G3M4

EXEMPLE DE INSTALARE

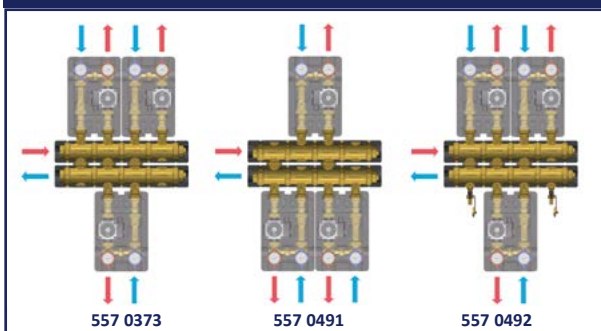

557 0373

557 0491

557 0492

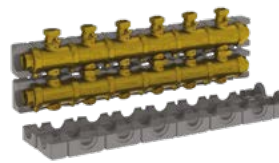
**5540G3M6**

Colector modular din alama pentru centrala termica cu robineti cu sfera, izolatie si cleme de fixare. Interaxa 125 mm, racorduri cu fata plana si piulita de 1"1/2

Cod	Dimens.	Nr. circuite	Debit max	Pret €	Ambalare
557 0374	2"1/2	3	6,5 (m³/h)		1/1
557 0493	2"1/2	3	6,5 (m³/h)		1/1
557 0494	2"1/2	3	6,5 (m³/h)		1/1

5540G3M6

EXEMPLE DE INSTALARE

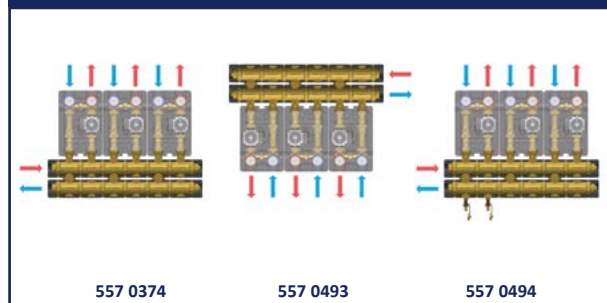

557 0374

557 0493

557 0494

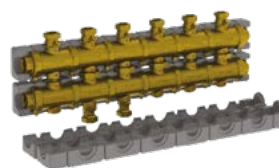
**5540G4M6**

Colector modular din alama pentru centrala termica cu robineti cu sfera, izolatie si cleme de fixare. Interaxa 125 mm, racorduri cu fata plana si piulita de 1"1/2

Cod	Dimens.	Nr. circuite	Debit max	Pret €	Ambalare
557 0375	2"1/2	4	6,5 (m³/h)		1/1
557 0495	2"1/2	4	6,5 (m³/h)		1/1
557 0496	2"1/2	4	6,5 (m³/h)		1/1

5540G4M6

EXEMPLE DE INSTALARE

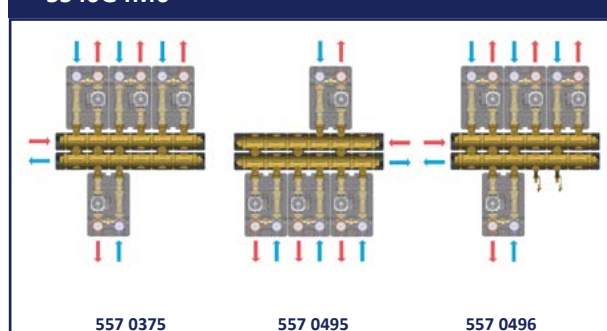

557 0375

557 0495

557 0496

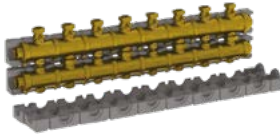
**5540G4M8**

Colector modular din alama pentru centrala termica cu robineti cu sfera, izolatie si cleme de fixare. Interaxa 125 mm, racorduri cu fata plana si piulita de 1"1/2

Cod	Dimens.	Nr. circuite	Debit max	Pret €	Ambalare
557 0376	2"1/2	4	6,5 (m ³ /h)		1/1
557 0497	2"1/2	4	6,5 (m ³ /h)		1/1
557 0498	2"1/2	4	6,5 (m ³ /h)		1/1

5540G4M8

EXEMPLE DE INSTALARE

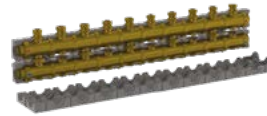
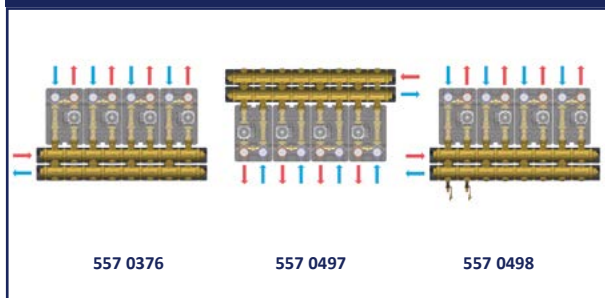
**5540G5M10**

Colector modular din alama pentru centrala termica cu robineti cu sfera, izolatie si cleme de fixare. Interaxa 125 mm, racorduri cu fata plana si piulita de 1"1/2

Cod	Dimens.	Nr. circuite	Debit max	Pret €	Ambalare
557 0476	2"1/2	5	6,5 (m ³ /h)		1/1
557 0501	2"1/2	5	6,5 (m ³ /h)		1/1
557 0502	2"1/2	5	6,5 (m ³ /h)		1/1

5540G5M10

EXEMPLE DE INSTALARE

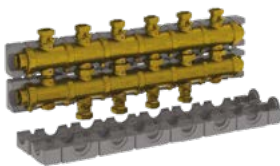
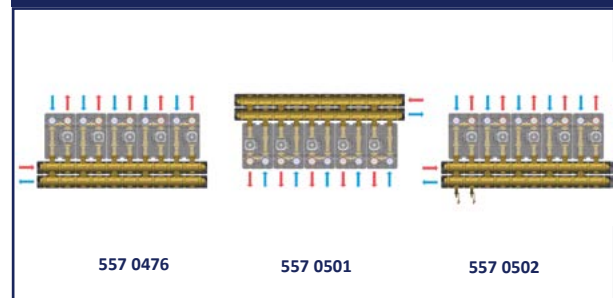
**5540G5M6**

Colector modular din alama pentru centrala termica cu robineti cu sfera, izolatie si cleme de fixare. Interaxa 125 mm, racorduri cu fata plana si piulita de 1"1/2

Cod	Dimens.	Nr. circuite	Debit max	Pret €	Ambalare
557 0377	2"1/2	5	6,5 (m ³ /h)		1/1
557 0499	2"1/2	5	6,5 (m ³ /h)		1/1
557 0500	2"1/2	5	6,5 (m ³ /h)		1/1

5540G5M6

EXEMPLE DE INSTALARE

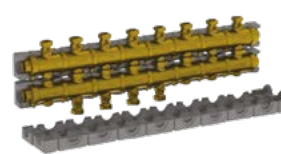
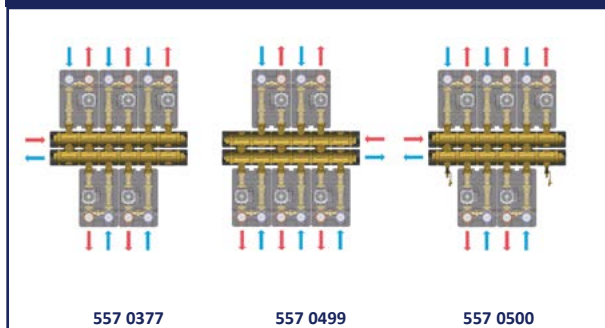
**5540G6M8**

Colector modular din alama pentru centrala termica cu robineti cu sfera, izolatie si cleme de fixare. Interaxa 125 mm, racorduri cu fata plana si piulita de 1"1/2

Cod	Dimens.	Nr. circuite	Debit max	Pret €	Ambalare
557 0378	2"1/2	6	6,5 (m ³ /h)		1/1
557 0503	2"1/2	6	6,5 (m ³ /h)		1/1
557 0504	2"1/2	6	6,5 (m ³ /h)		1/1

5540G6M8

EXEMPLE DE INSTALARE

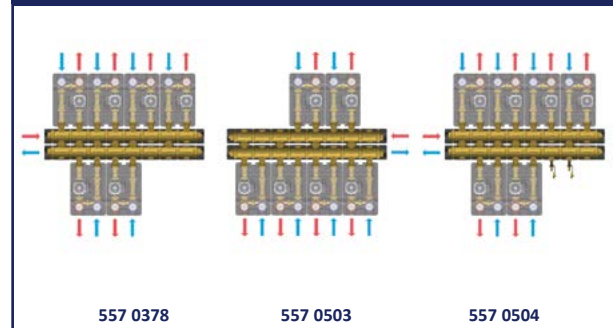

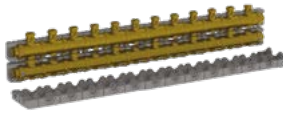

5540G6M12

Colector modular din alama pentru centrala termica cu robineti cu sfera, izolatie si cleme de fixare. Interaxa 125 mm, racorduri cu fata plana si piulita de 1"1/2

Cod	Dimens.	Nr. circuite	Debit max	Pret €	Ambalare
557 0505	2"1/2	6	6,5 (m³/h)		1/1
557 0506	2"1/2	6	6,5 (m³/h)		1/1
557 0507	2"1/2	6	6,5 (m³/h)		1/1

5540G6M12

EXEMPLE DE INSTALARE

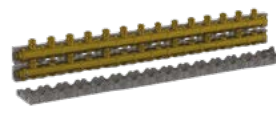
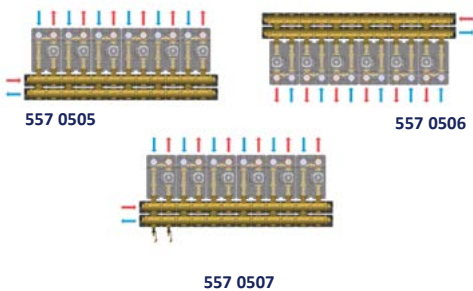

5540G7M14

Colector modular din alama pentru centrala termica cu robineti cu sfera, izolatie si cleme de fixare. Interaxa 125 mm, racorduri cu fata plana si piulita de 1"1/2

Cod	Dimens.	Nr. circuite	Debit max	Pret €	Ambalare
557 0472	2"1/2	7	6,5 (m³/h)		1/1
557 0511	2"1/2	7	6,5 (m³/h)		1/1
557 0512	2"1/2	7	6,5 (m³/h)		1/1

5540G7M14

EXEMPLE DE INSTALARE

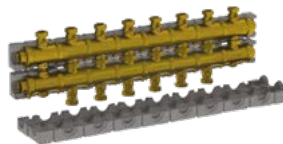
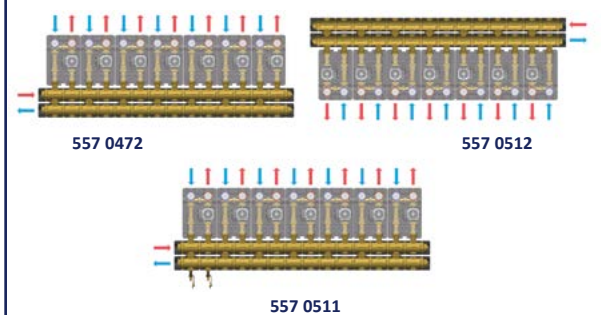

5540G7M8

Colector modular din alama pentru centrala termica cu robineti cu sfera, izolatie si cleme de fixare. Interaxa 125 mm, racorduri cu fata plana si piulita de 1"1/2

Cod	Dimens.	Nr. circuite	Debit max	Pret €	Ambalare
557 0508	2"1/2	7	6,5 (m³/h)		1/1
557 0509	2"1/2	7	6,5 (m³/h)		1/1
557 0510	2"1/2	7	6,5 (m³/h)		1/1

5540G7M8

EXEMPLE DE INSTALARE

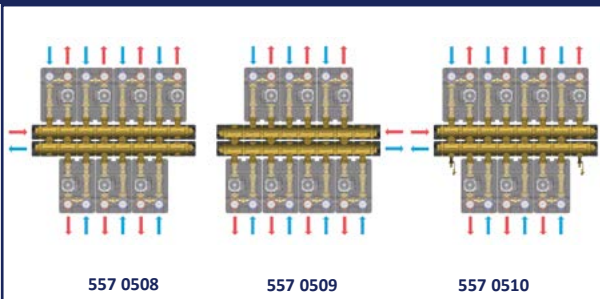

IMPORTANT

Se pot crea configuratii speciale, in functie de cerintele clientului



5538G

FUNCTIONARE

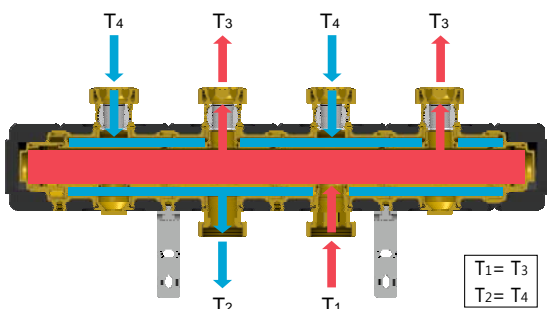

5540G

FUNCTIONARE

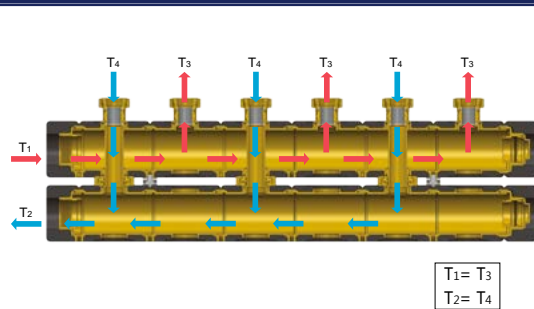

5538G - 5540G

INSTALARE

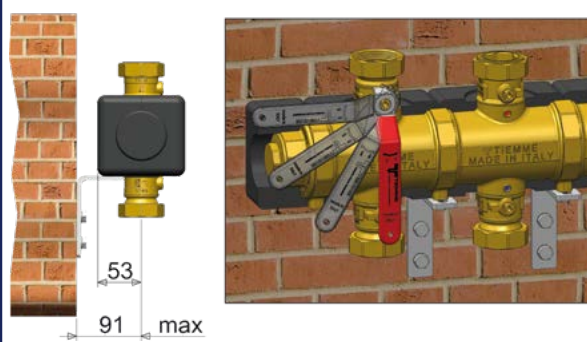

Instalarea pe perete este rapidă și ușoară datorită suportului special reglabil care poate fi fixat pe perete și pe colector cu ajutorul șuruburilor.

Scaunele pentru șuruburi au fost realizate direct pe colector. Cu robinetul cu bilă instalat direct pe colector, este posibil să se efectueze intervenții de întreținere întrerupând numai linia în cauză fără a opri restul instalației care va rămâne în funcțiune.

5538G - 5540G

GHID DE CONECTARE

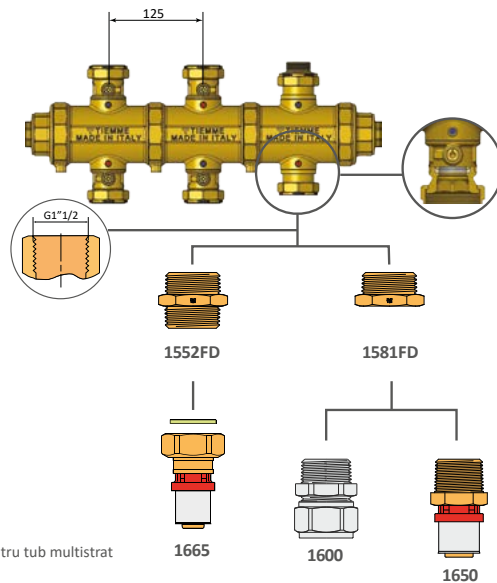
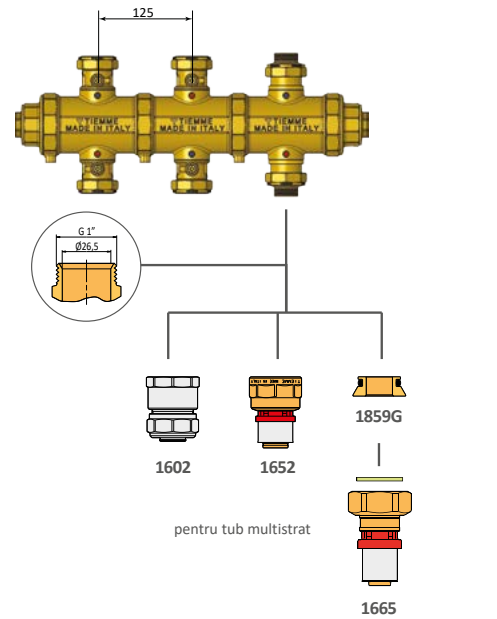

5540G

GHID DE CONECTARE

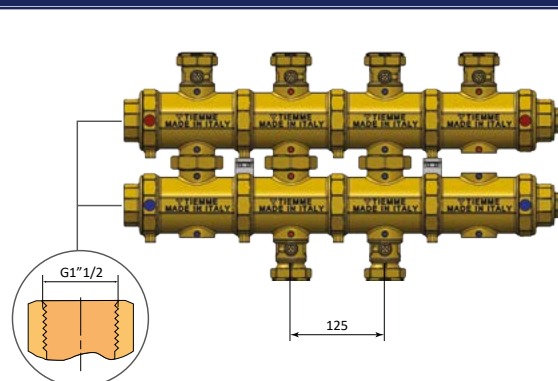

**1602**

Racord drept F
Pentru tub din polietilena reticulata cu insertie de aluminiu

Cod	Dimensiune	Pret €	Ambalare
160 0112	25 x 2,5 - 1"		5/50
160 0029	26 x 3,0 - 1"		5/100
160 0039	32 x 3,0 - 1"		5/50

**1652**

Racord drept F
Pentru tub din polietilena reticulata cu insertie de aluminiu

Cod	Dimensiune	Pret €	Ambalare
165 0268	25 x 2,5 - 1"		5/25
165 0053	26 x 3,0 - 1"		5/25
165 0050	32 x 3,0 - 1"		5/25

**1665**

Racord drept cu piulita si garnitura plata
Pentru tub din polietilena reticulata cu insertie de aluminiu

Cod	Dimensiune	Pret €	Ambalare
165 0233	25 x 2,5 - 1"		2/50
165 0071	26 x 3,0 - 1"		2/50
165 0134	32 x 3,0 - 1"		2/100
165 0239	40 x 3,5 - 1"1/2		1/25

Se utilizeaza cu 1859

Se utilizeaza cu 1552FD

**1859**

Adaptor pentru a transforma un filet conexiuni 1" G in filet cu fata planat

Cod	Dimensiune	Pret €	Ambalare
144 0234	1"G		10/300

**1552FD**

Niplu fata dreapta si garnitura plata

Cod	Dimensiune	Pret €	Ambalare
471 0086	1"1/2 x 1"1/2		2/30

**1881**

Reductie M/F cu garnitura O-ring pentru colectoare

Cod	Dimensiune	Pret €	Ambalare
195 0066	1" 1/2 x 3/4"		5/70

**1828Z**

Consola cu suruburi pentru colectoare pentru centrala termica

Cod	Dimensiune	Pret €	Ambalare
179 0323	unica		1/25

**2095R**

Maneta plata rosie din otel plastifiat

Cod	Dimensiune	Pret €	Ambalare
209 0069	unica		1/10

**2121CP**

Robinet M/F ISO 228 cu maneta de culoare rosie si albastra pentru colectoare si GARNITURA PLATA

Cod	Dimensiune	Pret €	Ambalare
 maneta tip levier rosie			
212 0122	1"1/2		3/12

Cod	Dimensiune	Pret €	Ambalare
 maneta tip levier neagra			
212 0124	1"1/2		3/12



5535G
Grup de pompare



CARACTERISTICI TEHNICE:

- Material corp: Alama CW 617 N
- Garnituri: EPDM
- Material izolat: EPP
- Dimensiune: DN 25 (1")
- Conexiuni:
 - Intrare: 1"1/2 etansare mecanica plana
 - Iesire: 1"1/2 etansare mecanica plana
- Presiunea maxima: 8 bar
- Temp. maxima de intrare: 110°C
- Pompe:
 - Grundfos UPM3 HYBRID 25/70
 - Grundfos UPS 25-65
 - Wilo PARA 25/7
 - Wilo PARA 25/9

Cod	Dimensiune	Pret €	Ambalare
316 0017	Fara pompa		1/1
316 0043	Wilo PARA 25/7		1/1
316 0042	UPM3 HYBRID 25/70		1/1
316 0090	Wilo PARA 25/9		1/1
316 0018	Grundfos UPS 25-65		1/1

ErP READY

Disponibila pentru tari non UE



5535GPF
Grup de amestec cu punct fix



CARACTERISTICI TEHNICE:

- Material corp: Alama CW 617 N
- Garnituri: EPDM
- Material izolat: EPP
- Dimensiune: DN 25 (1")
- Conexiuni:
 - Intrare: 1"1/2 etansare mecanica plana
 - Iesire: 1"1/2 etansare mecanica plana
- Presiunea maxima: 8 bar
- Temp. maxima de intrare: 110°C
- Domeniul de reglare: 20÷50°C
- Termostat de siguranta: 55°C
- Pompe:
 - Grundfos UPM3 HYBRID 25/70
 - Grundfos UPS 25-65
 - Wilo PARA 25/7
 - Wilo PARA 25/9

Cod	Dimensiune	Pret €	Ambalare
316 0020	Fara pompa		1/1
316 0046	Wilo PARA 25/7		1/1
316 0045	Grundfos UPM3 HYBRID 25/70		1/1
316 0091	Wilo PARA 25/9		1/1
316 0021	Grundfos UPS 25-65		1/1

ErP READY

Disponibila pentru tari non UE

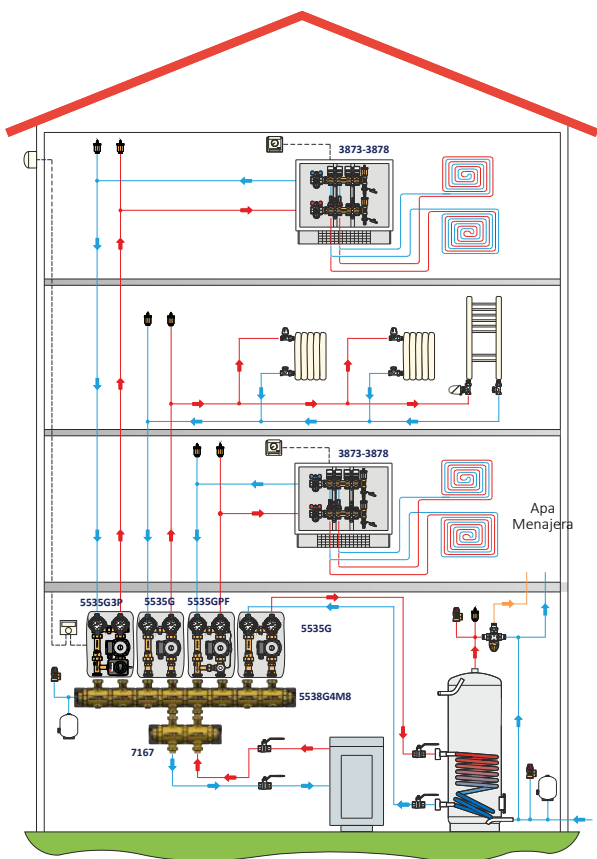

TUTORIAL VIDEO



Grupuri de pompare



5535G3P
Grup de amestec modulant



CARACTERISTICI TEHNICE:

- Material corp: Alama CW 617 N
- Garnituri: EPDM
- Material izolatie: EPP
- Dimensiune: DN 25 (1")
- Conexiuni:
 - Intrare: 1"1/2 etansare mecanica plana
 - Iesire: 1"1/2 etansare mecanica plana
- Presiunea maxima: 8 bar
- Temp. maxima de intrare: 110°C
- Pompe:
 - Grundfos UPM3 HYBRID 25/70
 - Grundfos UPS 25-65
 - Wilo PARA 25/7
 - Wilo PARA 25/9

SERVOMOTOR

- Alimentare: 230Vac comanda SPDT (3 puncte)
- Durata rotatiei: 120 secunde (unghi de 90°)
- Cuplu nominal: 7 Nm

Cod	Dimensiune	Pret €	Ambalare
316 0023	Fara pompa		1/1
316 0049	Wilo PARA 25/7		1/1
316 0048	Grundfos UPM3 HYBRID 25/70		1/1
316 0092	Wilo PARA 25/9		1/1

ErP READY



5536G
Grup de pompare cu izolatie pentru racire



CARACTERISTICI TEHNICE:

- Material corp: Alama CW 617 N
 - Garnituri: EPDM
 - Material izolatie: PE-X expandat cu celule inchise
 - Dimensiune: DN 25 (1")
 - Intrare: 1"1/2 etansare mecanica plana
 - Iesire: 1"1/2 etansare mecanica plana
 - 8 bar
 - 110°C
 - Wilo PARA 25/7
 - Wilo PARA 25/9
- Presiunea maxima:
Temp. maxima de intrare:
Pompe:

Cod	Dimensiune	Pret €	Ambalare
557 0383	Fara pompa		1/1
557 0386	Wilo PARA 25/7		1/1
557 0559	Wilo PARA 25/9		1/1

ErP READY





5536GS

Grup de amestec modulant si izolatie pentru racire



CARACTERISTICI TEHNICE:

- Material corp: Alama CW 617 N
- Garnituri: EPDM
- Material izolatie: PE-X expandat cu celule inchise
- Dimensiune: DN 25 (1")
- Conexiuni:
 - Intrare: 1"1/2 etansare mecanica plana
 - Iesire: 1"1/2 etansare mecanica plana
- Presiunea maxima: 8 bar
- Temp. maxima de intrare: 110°C
- Pompe:
 - Wilo PARA 25/7
 - Wilo PARA 25/9

SERVOMOTOR

- Alimentare: 24Vac comanda 0-10Vdc
- Durata rotatiei: 120 secunde (unghi de 90°)
- Cuplu nominal: 7 Nm

Cod	Dimensiune	Pret €	Ambalare
557 0388	Fara pompa		1/1
557 0391	Wilo PARA 25/7		1/1
557 0560	Wilo PARA 25/9		1/1

ErP READY



5534G

Grup de pompare



CARACTERISTICI TEHNICE:

- Material corp: alama CW 617 N
- Material garnituri: EPDM
- Material carcasă izolatoare: EPP
- Dimensiune: DN32 (1"1 / 4)
- Distanța interax 125 mm:
 - Intrare: 1"1/2 fata plana
 - Iesire: 1"1/4 feminin
- Pmax de utilizare: 8 bar
- Tmax de utilizare: 110 ° C

Cod	Dimensiune	Pret €	Ambalare
316 0093	Fara pompa		1/1
316 0095	Grundfos UPML 32-105 AUTO		1/1

ErP READY



5534G3P

Grup de amestec pentru servomotor (nu este inclus)



CARACTERISTICI TEHNICE:

- Material caroserie: alama CW 617 N
- Material garnituri: EPDM
- Material carcasă izolatoare: EPP
- Dimensiune: DN 32
- Distanța interax 125 mm:
 - Intrare: 1"1/2 fata plana
 - Iesire: 1"1/4 feminin
- Pmax de utilizare: 8 bar
- Tmax de utilizare: 110 ° C

Pentru a fi utilizat cu servomotorul 9562SERV

Cod	Dimensiune	Pret €	Ambalare
316 0097	Fara pompa		1/1
316 0099	Grundfos UPML 32-105 AUTO		1/1

ErP READY

**5535DIFF**

By-pass diferential cu camp de reglare 50-400 mbar. Racord masculin 25x1,5 (utilizabil cu toate grupurile hidraulice)

Cod	Dimensiune	Pret €	Ambalare
316 0029	50-400 mbar		1/50

**2075KIT03**

Termostat de siguranta tip pastila cu cablu si conector drept

Cod	Dimensiune	Pret €	Ambalare
557 0024	55 °C		1/50

**3880GPF**

Vana de amestec pentru reglare cu punct fix

i Se cupleaza la kitul termostatic 9561KIT02

Cod	Dimensiune	Pret €	Ambalare
316 0030	-		1/4

**9561KIT02**

Kit niplu + tub + cap termostatic 20-50°C cu sonda la distant Ø 9 mm. Racord masculin M30x1,5

i Se utilizeaza cu grupul de amestec cu punct fix 5535GPF

Cod	Dimensiune	Pret €	Ambalare
450 0150	20-50 °C		1/10

**3880GSM**

Vana de amestec zona pentru comanda servomotor (nu este furnizat)

i Pentru a fi utilizat cu servomotorul 9562SERV

Cod	Dimensiune	Pret €	Ambalare
316 0031	-		1/4

**9562SERV**

Servomotor complet cu kit pentru conectarea vanei de amestec art. 3880GSM

CARACTERISTICI TEHNICE:

- Material corp: Nylon FV ignifug
- Timp de rotatie: 120 sec
- Unghi de rotatie: 90°
- Cuplu nominal: 7 Nm
- Grad de protectie: IP 40
- Alimentare:
 - 230 Vac SPDT (3 puncte)
 - 24 Vac SPDT (3 puncte)
 - 24 Vac (0-10 Vdc)

Cod	Dimensiune	Pret €	Ambalare
557 0023	230 Vac comanda SPDT (3 puncte)		1/8
557 0306	24 Vac comanda SPDT (3 puncte)		1/8
557 0307	24 Vac comanda 0-10 Vdc		1/8

**4745MANOP**

Maner cu termometru de imersie pentru grupuri hidraulice

Cod	Dimensiune	Pret €	Ambalare
470 0183	Albastru		10/40
470 0184	Rosie		10/40

**5537KIT**

Kit niplu + tub pentru sonda Ø 6 mm. Racord masculin 25x1,5

i Se utilizeaza cu grupul de amestec cu servomotor 5535G3P

Cod	Dimensiune	Pret €	Ambalare
557 0022	-		1/25



**1665**

Racord drept cu piulita și garnitura plată
Pentru tub din polietilena reticulată cu insertie de aluminiu

Cod	Dimensiune	Pret €	Ambalare
165 0240	32 x 1"1/2		1/50
165 0239	40 x 1"1/2		1/25

**1557SET**

Set olandez din alama pentru pompa cu racord F/F și garnitura plată

i Setul include: 2 stuturi, 2 piulițe, 2 garnituri

Cod	Dimensiune	Atac pompa	Pret €	Ambalare
150 0355	1"	1"1/2		1/20

**3890PW2**

Pompa de circulație de înaltă eficiență Wilo PARA 25/7 cu interaxa 130 mm. Iesire 1"1/2 corp de fontă.

+ POMPE DE INALTA EFICIENTA

Cod	Dimensiune	Pret €	Ambalare
450 0358	Wilo PARA 25/7		1/1

**3890PW5**

Pompa de circulație de înaltă eficiență Wilo PARA 25/9 cu interaxa 130 mm. Iesire 1"1/2 corp de fontă.

+ POMPE DE INALTA EFICIENTA

Cod	Dimensiune	Pret €	Ambalare
450 0557	Wilo PARA 25/9		1/1

**3890PV**

Pompa de circulație cu flux variabil clasa A. Iesiri de 1"1/2 interaxa 130 mm

+ POMPE DE INALTA EFICIENTA

Cod	Dimensiune	Pret €	Ambalare
450 0091	Grundfos UPM3 HYBRID 25/70		1/1

**3890P**

Pompa de circulație cu trei viteze. Iesiri de 1"1/2 interaxa 130 mm.

Cod	Dimensiune	Pret €	Ambalare
450 0033	Grundfos UPS 25-55		1/1

Disponibila pentru tari non UE

**3890PU**

Pompă de circulație de înaltă eficiență. Conexiuni de 2", distanță interax 180 mm

+ POMPE DE INALTA EFICIENTA

Cod	Dimensiune	Pret €	Ambalare
450 0637	Grundfos UPML 32-105		1/1

**3150**

TM-MAG MINI Filtru impuritati magnetice compact pentru centrala murala

**CARACTERISTICI TEHNICE:**

- Gradul de filtrare: 800 µm
- Material corp: alamă CW617N / PA6.6 30% F.V.
- Temperatura maxima de lucru: 90°C

Cod	Dimensiune	Pret €	Ambalare
315 0039	3/4"		1/10

**3146KIT**

Kit TM-MAG pentru centrala murala

**CARACTERISTICI TEHNICE:**

- Grad de filtrare: 800 µm
- Materialul paharului colector: policarbonat
- Corp: din alama CW 617N nichelat
- Temperatura maxima de exercitiu: 95°C
- Livrat cu robinet de golire

i Setul include: 1 filtru TM-MAG 3/4", 1 robinet cu bilă F cu piuliță 3/4" cu fluture roșu, 1 robinet cu bilă F cu piuliță de 1/2" cu fluture roșu, 1 robinet cu bilă F cu 3/4" robinet cu fluture albastru și filtru Y de 1/2"

Cod	Dimensiune	Pret €	Ambalare
315 0016	3/4"		1/4

**3142**

TM-MAG Filtru magnetic sub centrala cu robinet cu sfera si pahar colector alama CW617N

**CARACTERISTICI TEHNICE:**

- Grad de filtrare: 800 µm
- Materialul paharului colector: din alama CW 617N nichelat
- Corp: din alama CW 617N nichelat
- Temperatura maxima de exercitiu: 95°C
- Livrat cu robinet de golire

Cod	Dimensiune	Pret €	Ambalare
315 0030	3/4"		1/8

**3154**

TM-MAG EVO Filtru magnetic de separare a murdăriei situat sub centrala termica cu „by-pass” si surub.

**CARACTERISTICI TEHNICE:**

- Gradul de filtrare: 800 µm
- Material corp: alamă CW617N nichelat
- Temperatura maxima de lucru: 95°C

CU BY-PASS

Cod	Dimensiune	Pret €	Ambalare
315 0071	3/4"		1/10

TUTORIAL VIDEO

TM-MAG EVO Filtru magnetic cu separator impuritati

MORE INFO

**3154C**

Set (robinet + garnitura) pentru filtru magnetic situat sub centrala termica cu „bypass” si surub (Art. 3154)

Cod	Dimensiune	Pret €	Ambalare
313 0135	1/2"		1/50

La cerere

**3148**

Filtru magnetic linear cu separator de impuritati, cu pahar colector alama CW617N si set de prindere, racorduri exterioare tip olandez M/M

**CARACTERISTICI TEHNICE:**

- Materialul paharului colector: alama CW 617N
- Corp: din alama CW 617N
- Presiune maxima de exercitiu: 10 bar
- Temperatura maxima de exercitiu: 95°C
- Filete interioare: M/M ISO 228
- Livrat cu si robinet de golire

Cod	Dimensiune	Pret €	Ambalare
315 0005	1/2"		1/14
315 0006	3/4"		1/14
315 0007	1"		1/14
315 0008	1"1/4		1/14



LISTA DE PREȚURI

**3149**

Filtru magnetic linear cu separator de impuritati, cu pahar colector alama CW617N si set de prindere, cu iesiri M/F

**CARACTERISTICI TEHNICE:**

- Materialul paharului colector: alama CW 617N
- Corp: din alama CW 617
- Presiune maxima de exercitiu: 10 bar
- Temperatura maxima de exercitiu: 95°C
- Filete interioare: F/M ISO 228
- Livrat cu si robinet de golire

Cod	Dimensiune F M	Pret €	Ambalare
315 0009	1/2" x 3/4"		1/14
315 0010	3/4" x 1"		1/14
315 0011	1" x 1"1/4		1/14
315 0012	1"1/4 x 1"1/2		1/14

**3141**

TM-MAG PLUS Filtru magnetic cu separator de impuritati

**CARATTERISTICHE TECNICHE**

- Gradul de filtrare: 800 µm
- Material corp: PA66 + FV 30%
- Temperatura maxima de lucru: 95°C

ORIENTABIL

Cod	Dimensiune	Pret €	Ambalare
315 0032	3/4"		1/4
315 0038	1"		1/4

**1525N**

Racord drept M nichelat cu piulita si garnitura plata

Cod	Dimensiune	Pret €	Ambalare
150 0891	1/2" x 1/2"		5/100

**1524**

Racord drept F-F cu olandez si garnitura plata

Cod	Dimensiune	Pret €	Ambalare
150 0858	3/4"		1/100

**3146X**

Cartuş de schimb pentru filtrul magnetic sub centrala

Cod	Dimensiune	Pret €	Ambalare
313 0090	-		1/50

**3148A**

Inel cu magneţi

Cod	Dimensiune	Pret €	Ambalare
313 0105	-		1/14

**3146OR**

O-ring pentru filtru magnetic sub centrala

Cod	Dimensiune	Pret €	Ambalare
040 0118	-		10/1000

**3142T**

Pahar de alamă de schimb pentru filtrul magnetic sub centrala

Cod	Dimensiune	Pret €	Ambalare
313 0128	-		1/15

**3155**

ULISSE Dozator proportional cu cristale de polifosfati, cu supapa de blocare si cartus, livrat cu un cartus de schimb

Cod	Dimensiune	Pret €	Ambalare
310 0001	1/2"		1/6

**3155POL**

Cartus de schimb cu cristale de polifosfati pentru dozatorul proportional (2 seturi)

Cod	Dimensiune	Pret €	Ambalare
310 0003	pentru art. 3155		1/10

**1896**

Supapa automata de aerisire nichelata

Cod	Dimensiune	Pret €	Ambalare
198 0068	1/2"		1/20
198 0074	3/4"		1/20

Conexiune masculin cu etanșare O-ring

**1896GG**

Ansamblu Flotor pentru supapele de aerisire automate art 1896

Cod	Dimensiune	Pret €	Ambalare
198 0070	-		1/20

**1914**

Supapă de aerisire automată nichelată, racord lateral

Cod	Dimensiune	∅	Pret €	Ambalare
198 0126	3/8"	39		1/50
198 0127	1/2"	39		1/50

**1913**

Supapa automata de aerisire nichelata

Cod	Dimensiune	∅	Pret €	Ambalare
198 0128	3/8"	39		1/50
198 0129	1/2"	39		1/50



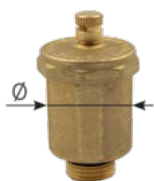

1913G
Supapa automata de aerisire

Cod	Dimensiune	Ø	Pret €	Ambalare
198 0130	3/8"	39		1/50
198 0131	1/2"	39		1/50



1898
Supapa automata de aerisire laterala

Cod	Dimensiune	Ø	Pret €	Ambalare
198 0005	3/8"	39		1/50
198 0004	1/2"	39		1/50



1898G34
Supapa automata de aerisire laterala cu corp de 34 mm

Cod	Dimensiune	Ø	Pret €	Ambalare
198 0114	3/8"	34		1/70
198 0092	1/2"	34		1/70



1898KIT34
Set Supapa automata de aerisire + Supapa de blocare

 Kit format din 1898G34 + 1901P

Cod	Dimensiune	Ø	Pret €	Ambalare
198 0112	3/8"	34		1/70
198 0113	1/2"	34		1/70



1899
Supapa automata de aerisire cu racord laterala

Cod	Dimensiune	Ø	Pret €	Ambalare
198 0011	3/8"	39		1/50
198 0003	1/2"	39		1/50

Până la terminarea stocului



1900
Supapa automata de aerisire

Cod	Dimensiune	Ø	Pret €	Ambalare
198 0002	3/8"	39		1/50
198 0001	1/2"	39		1/50
198 0013	3/4"	45,5		1/25
198 0022	1"	45,5		1/25

Până la terminarea stocului

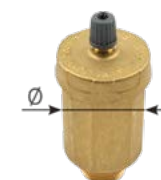

1900G
Supapa automata de aerisire

Cod	Dimensiune	Ø	Pret €	Ambalare
198 0014	3/8"	39		1/50
198 0007	1/2"	39		1/50

Până la terminarea stocului



1900N34
Supapa automata de aerisire

Cod	Dimensiune	Ø	Pret €	Ambalare
198 0024	3/8"	34		1/40
198 0029	1/2"	34		1/40



1900G34
Supapa automata de aerisire

Cod	Dimensiune	Ø	Pret €	Ambalare
198 0017	3/8"	34		1/40
198 0019	1/2"	34		1/40



3350
Supapa de aerisire pentru radiatoare

Cod	Dimensiune	Pret €	Ambalare
198 0021	1/8"		10/500
198 0020	1/4"		10/500
198 0015	3/8"		10/500
198 0016	1/2"		10/500



3351
Supapa de aerisire pentru radiatoare, cu garnitura de etansare

Cod	Dimensiune	Pret €	Ambalare
198 0010	1/4"		10/500
198 0008	3/8"		10/500
198 0006	1/2"		10/500



3352
Supapa de aerisire pentru radiatoare

Cod	Dimensiune	Pret €	Ambalare
198 0049	1/4"		10/500
198 0047	3/8"		10/500
198 0018	1/2"		10/500



1901
Supapa de blocare cu garnitura de etansare si obturator din alama

Cod	Dimensiune	Pret €	Ambalare
198 0012	3/8"		10/300
198 0009	1/2"		10/100
198 0023	M 1/2" - F 3/8"		10/300



1901P
Supapa de blocare cu garnitura de etansare si obturator din plastic

Cod	Dimensiune	Pret €	Ambalare
198 0106	3/8"		10/300
198 0108	1/2"		10/300
198 0110	M 1/2" - F 3/8"		10/300



1901PN
Supapa de blocare nichelata cu garnitura de etansare si obturator din plastic

Cod	Dimensiune	Pret €	Ambalare
198 0107	3/8"		10/300
198 0109	1/2"		10/300
198 0111	M 1/2" - F 3/8"		10/300

La cerere





5532PDC
Modul hidronic de coordonare
PDC-ACM

Cod	Dimensiune	Pret €	Ambalare
556 0272	1"		1/1

5532PDC GHID DE INSTALARE

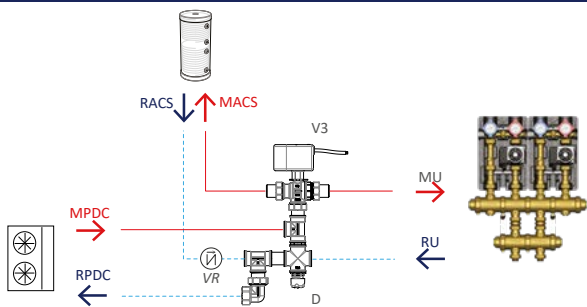

LEGENDĂ

- MU: tur alimentare
- RU: retur alimentare
- MACS: tur apă caldă menajeră
- RACS: retur apă caldă menajeră
- MPDC: tur pompă de căldură
- RPDC: retur pompă de căldură
- V3: supapă cu 3 căi motorizată
- VR: Supapă de reținere
- D: By-pass diferențial



5532HYBRID
Modul hidronic de coordonare
sursa dubla

Cod	Dimensiune	Pret €	Ambalare
556 0273	1"		1/1

5532HYBRID GHID DE INSTALARE

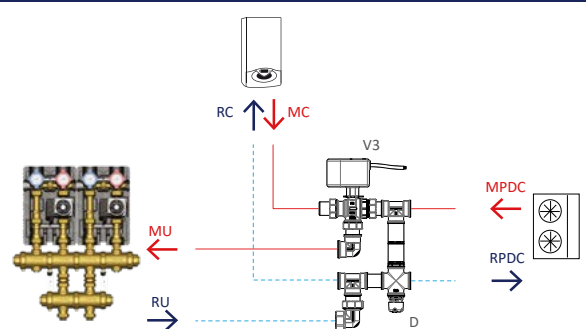

LEGENDĂ

- MC: tur centrală
- RC: retur centrală
- MU: tur alimentare
- RU: retur alimentare
- MPDC: tur pompă de căldură
- RPDC: retur pompă de căldură
- V3: supapă cu 3 căi motorizată
- D: By-pass diferențial

NOUȚĂȚI



1926
Supapa anti-înghet pentru
pompa de caldura

Cod	Dimensiune	Pret €	Ambalare
192 0157	1"		1/10
192 0158	1"1/4		1/10



3890VD

Vana termostatică cu 3 cai deviație/amestec pentru gestiunea instalațiilor de încălzire și răcire.

În funcție de poziția de montaj funcționează ca vana deviatoare sau ca vana de amestec.

Cod	Dimensiune	Pret €	Ambalare
450 0047	1"		2/20
450 0515	1"1/4		1/10
450 0516	1"1/2		1/10

3890VD

GHID DE INSTALARE

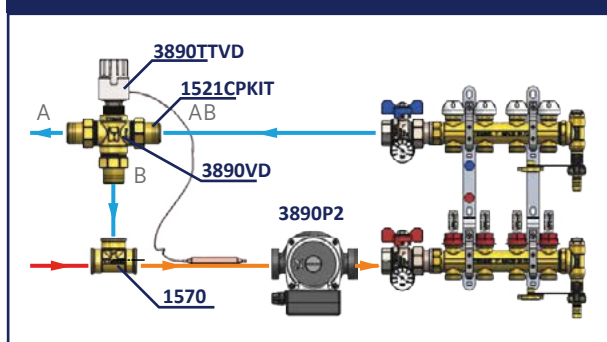

1521CPKIT

Kit olandez pentru Vana termostatică cu 3 cai deviație/amestec

i Setul include: 3 stuturi, 3 piulițe, 3 garnituri

Cod	Dimensiune	Pret €	Ambalare
150 1017	1" F x 3/4" M		1/20
150 1013	1"1/4 F x 1" M		1/15
150 1014	1"1/2 F x 1"1/4 M		1/10



1570

Teu F

Cod	Dimensiune	Pret €	Ambalare
150 0009	3/4" x 3/4" x 3/4"		5/50
150 0005	1" x 1" x 1"		5/25
150 0029	1"1/4 x 1"1/4 x 1"1/4		5/20



3890TTVD

Cap termostatic cu sonda la distanță pentru supapa de deviere

Cod	Dimensiune	Pret €	Ambalare
450 0527	20 - 50°C		1/10
450 0556	40 - 70°C		1/10



**4732**

Supapa de siguranta anti-condensare

i Alte calibrari disponibile la cerere

Cod	Dimensiune	Pret €	Ambalare
324 0017	1" 60°C		1/8
324 0018	1"1/4 60°C		1/4
324 0019	1"1/2 60°C		1/4

**1521CPKIT**

Kit olandez

i Setul include: 3 stuturi, 3 piulițe pivotante, 3 garnituri

Cod	Dimensiune	Pret €	Ambalare
150 1017	1" F x 3/4" M		1/20
150 1013	1"1/4 F x 1" M		1/15
150 1014	1"1/2 F x 1"1/4 M		1/10

4737

GHID DE INSTALARE

Funcție de amestecare anti-condens

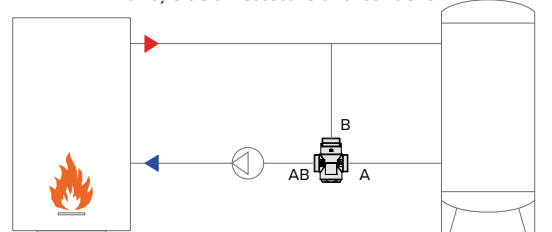

Funcția de deviere

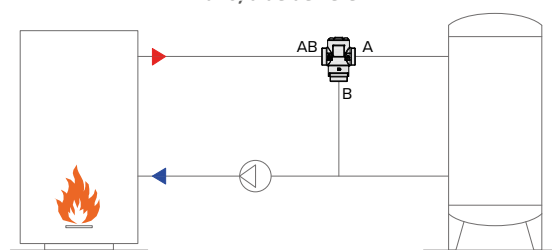
**6535G**

Robinet de echilibrare din alama pentru circuite hidraulice cu cititor de presiune

i Accesorii: 6535ISOL - 6535ET - 6536
Piese de schimb: 6535PP
Pentru coduri vezi pagina 349

Cod	Dimensiune	Pret €	Ambalare
651 0008	1/2"		1/5
651 0009	3/4"		1/5
651 0010	1"		1/5
651 0011	1"1/4		1/5
651 0012	1"1/2		1/4
651 0013	2"		1/4

**6535DN**

Robinet de echilibrare din fonta pentru circuite hidraulice, cu cititor de presiune

i Accesorii: 6535DNISOL - 6535ET - 6536
Piese de schimb: 6535PP - 6535DNMANOP
Pentru coduri vezi pagina 349

Cod	Dimensiune	Pret €	Ambalare
651 0269	DN65		1/1
651 0270	DN80		1/1
651 0271	DN100		1/1
651 0272	DN125		1/1
651 0273	DN150		1/1
651 0274	DN200		1/1

La cerere



6541CC

Robinet de echilibrare dinamică TIEMME-BASIC F/F cu cartuș reglabil intern și conexiuni prize de presiune (opțional)

i Accesorii: 6542PP - 6535ET
Pentru coduri vezi pagina 349

Cod	Corpul supapei	Dimensiunea cartusului	Gama ΔP	Culoare cartus	Debit l/h	Pret €	Ambalare
651 0753	1/2" (DN15)	DN20	20 - 130 kPa	Grey	29 - 155		1/10
651 0754			20 - 130 kPa	Red	207 - 430		1/10
651 0755			20 - 130 kPa	Blue	223 - 526		1/10
651 0756			20 - 130 kPa	Black	162 - 695		1/10
651 0757			20 - 130 kPa	Green	112 - 984		1/10
651 0758			40 - 400 kPa	Grey	42 - 250		1/10
651 0760			40 - 400 kPa	Red	281 - 653		1/10
651 0762			40 - 400 kPa	Blue	203 - 792		1/10
651 0764			40 - 400 kPa	Black	215 - 998		1/10
651 0765			40 - 400 kPa	Green	529 - 1470		1/10
651 0766	3/4" (DN20)	DN20	20 - 130 kPa	Grey	29 - 155		1/10
651 0767			20 - 130 kPa	Red	207 - 430		1/10
651 0768			20 - 130 kPa	Blue	223 - 526		1/10
651 0769			20 - 130 kPa	Black	162 - 695		1/10
651 0770			20 - 130 kPa	Green	112 - 984		1/10
651 0771			40 - 400 kPa	Grey	42 - 250		1/10
651 0772			40 - 400 kPa	Red	281 - 653		1/10
651 0773			40 - 400 kPa	Blue	203 - 792		1/10
651 0774			40 - 400 kPa	Black	215 - 998		1/10
651 0775			40 - 400 kPa	Green	529 - 1470		1/10
651 0776	1" (DN25 small)	DN20	20 - 130 kPa	Grey	29 - 155		1/10
651 0777			20 - 130 kPa	Red	207 - 430		1/10
651 0778			20 - 130 kPa	Blue	223 - 526		1/10
651 0779			20 - 130 kPa	Black	162 - 695		1/10
651 0780			20 - 130 kPa	Green	112 - 984		1/10
651 0781			40 - 400 kPa	Grey	42 - 250		1/10
651 0782			40 - 400 kPa	Red	281 - 653		1/10
651 0783			40 - 400 kPa	Blue	203 - 792		1/10
651 0784			40 - 400 kPa	Black	215 - 998		1/10
651 0785			40 - 400 kPa	Green	529 - 1470		1/10

La cerere





6542CC

Robinet de echilibrare dinamică TIEMME-EASY F/F cu cartuș reglabil extern

i Accesorii: 6543CH - 6535ET
 Piese de schimb: 6542PP
 Pentru coduri vezi pagina 349

Cod	Corpul supapei	Dimensiunea cartusului	Gama ΔP	Culoare cartus	Debit l/h	Pret €	Ambalare
651 0786	1/2" (DN15)	DN20	17 - 210 kPa	■ Black	100 - 412		1/10
651 0787			17 - 210 kPa	■ Green	157 - 609		1/10
651 0788			35 - 400 kPa	■ Black	138 - 615		1/10
651 0789			35 - 400 kPa	■ Green	238 - 896		1/10
651 0790			17 - 200 kPa	■ Red - □ White	276 - 825		1/10
651 0791	3/4" (DN20)	DN20	30 - 400 kPa	■ Red - ■ Grey	406 - 1270		1/10
651 0792			17 - 210 kPa	■ Black	100 - 412		1/10
651 0793			17 - 210 kPa	■ Green	157 - 609		1/10
651 0794			35 - 400 kPa	■ Black	138 - 615		1/10
651 0795			35 - 400 kPa	■ Green	238 - 896		1/10
651 0796	1" (DN25 small)	DN20	17 - 200 kPa	■ Red - □ White	276 - 825		1/10
651 0797			30 - 400 kPa	■ Red - ■ Grey	406 - 1270		1/10
651 0798			17 - 210 kPa	■ Black	100 - 412		1/10
651 0799			17 - 210 kPa	■ Green	157 - 609		1/10
651 0800			35 - 400 kPa	■ Black	138 - 615		1/10
651 0801	1" (DN25 large)	DN40	35 - 400 kPa	■ Green	238 - 896		1/10
651 0802			17 - 200 kPa	■ Red - □ White	276 - 825		1/10
651 0803			30 - 400 kPa	■ Red - ■ Grey	406 - 1270		1/10
651 0804	1"1/4 (DN32)	DN40	17 - 400 kPa	■ Black	535 - 5830		1/4
651 0805	1"1/2 (DN40)	DN50	20 - 400 kPa	□ White	3180 - 16100		1/3
651 0807	2" (DN50)	DN50	20 - 400 kPa	□ White	3180 - 16100		1/3

La cerere

**6542CCS**Robinet de echilibrare dinamică TIEMME-AUTO F/F cu cartuș reglabil extern pregătit pentru servomotor

i Accesorii: 6543CH (Per Green 0, Green 1, Green 2) - 6545CH (Per Green 3) - 6542SERV (Per Green 0, Green 1, Green 2)
 - 6542SERV2 (Per Green 3) - 6542ATT (Per Green 0, Green 1, Green 2) - 6535ET
 Piese de schimb: 6542PP
 Pentru coduri vezi pagina 349

Cod	Corpul supapei	Dimensiunea cartusului	Gama ΔP	Culoare cartus	Debit l/h	Pret €	Ambalare
651 0808	1/2" (DN15)	DN20	16 - 200 kPa	Green 0 grey o-ring	37 - 575		1/10
651 0809		DN20	30 - 800 kPa	Green 1 black o-ring	64 - 1110		1/10
651 0810	3/4" (DN20)	DN20	16 - 200 kPa	Green 0 grey o-ring	37 - 575		1/10
651 0811		DN20	30 - 800 kPa	Green 1 black o-ring	64 - 1110		1/10
651 0812	1" (DN25 small)	DN20	16 - 200 kPa	Green 0 grey o-ring	37 - 575		1/10
651 0813		DN20	30 - 800 kPa	Green 1 black o-ring	64 - 1110		1/10
651 0820	1" (DN25 large)	DN40	16 - 800 kPa	Green 2 black o-ring	865 - 4630		1/8
651 0821	1"1/4 (DN32)	DN40	16 - 800 kPa	Green 2 black o-ring	865 - 4630		1/10
651 0822	1"1/2 (DN40)	-	16 - 400 kPa	Green 3	1900 - 13647		1/1
651 0823	2" (DN50)	-	16 - 400 kPa	Green 3	1900 - 13647		1/1

La cerere





6538

Robinet de echilibrare cu reglaj la presiune diferentia

i Accesorii: 6543CH - 6539 - 6535ET
 Piese de schimb: 6542PP
 Pentru coduri vezi pagina 349

Cod	Corpul supapei	Dimensiunea cartusului	Gama ΔP	Debit l/h	Pret €	Ambalare
651 0626	1/2" (DN15)	DN20	5 - 50 kPa	15 - 2000		1/10
651 0627	3/4" (DN20)	DN20	5 - 50 kPa	15 - 2000		1/10
651 0628	1" (DN25 Small)	DN20	5 - 50 kPa	15 - 2000		1/10
651 0898	1" (DN25 Large)	DN40	5 - 60 kPa	15 - 5980		1/10
651 0629	1"1/4 (DN32)	DN40	5 - 60 kPa	15 - 5980		1/10
651 0630	1"1/2 (DN40)	DN50	5 - 100 kPa	200 - 14000		1/3
651 0631	2" (DN50)	DN50	5 - 100 kPa	200 - 14000		1/3

La cerere



6539

Robinet de echilibrare cu racorduri pentru citirea presiunii

i Accesorii: 6535ET
 Piese de schimb: 6535PP
 Pentru coduri vezi pagina 349

Cod	Dimensiune	Pret €	Ambalare
651 0632	1/2"		1/5
651 0633	3/4"		1/5
651 0634	1"		1/5
651 0635	1"1/4		1/5
651 0636	1"1/2		1/4
651 0637	2"		1/4

6538 - 6539

GHID DE INSTALARE

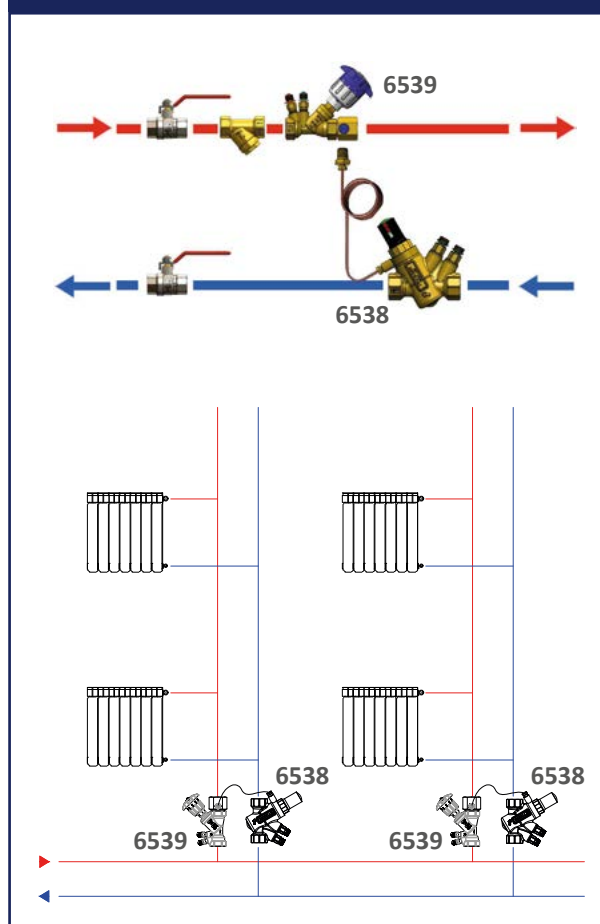



6540

Robinet de echilibrare cu reglaj la presiune diferentia si actuator on/off

i Accesorii: 6543CH - 6542ATT - 6535ET
 Piese de schimb: 6542PP
 Pentru coduri vezi pagina 349

Cod	Dimensiune	Gama ΔP	Debit l/h	Pret €	Ambalare
651 0920	1/2"	3 - 17 kPa	9 - 680		1/10
651 0921	3/4"	3 - 17 kPa	9 - 680		1/10
651 0922	1"	3 - 17 kPa	9 - 680		1/10

6540

GHID DE INSTALARE

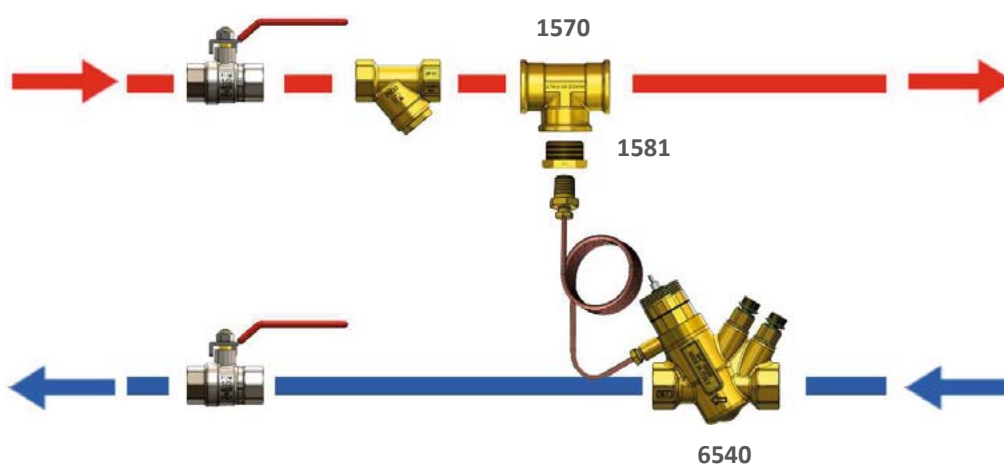



6535ISOL

Izolatie din polistiren expandat pentru robinet de echilibrare filetat

i Pentru robinet 6535G

Cod	Dimensiune	Pret €	Ambalare
651 0229	1/2"		1/10
651 0230	3/4"		1/10
651 0231	1"		1/10
651 0232	1"1/4		1/10
651 0233	1"1/2		1/10
651 0234	2"		1/10



6535DNISOL

Izolatie din polistiren expandat cu celule inchise pentru robinet de echilibrare art. 6535DN

i Pentru robinet 6535DN

Cod	Dimensiune	Pret €	Ambalare
651 0275	DN65		1/1
651 0276	DN80		1/1
651 0277	DN100		1/1
651 0278	DN125		1/1
651 0279	DN150		1/1
651 0280	DN200		1/1

La cerere



6535DNMANOP

Maneta tip rozeta pentru robinetii de echilibrare Art. 6535DN

i Pentru robinet 6535DN

Cod	Dimensiune	Pret €	Ambalare
651 0281	DN65 - DN150		1/1
651 0282	DN200		1/1

La cerere



6535PP

Set prize de citit presiunea rosu si albastru

i Pentru robinet 6535G - 6535DN - 6539

Cod	Dimensiune	Pret €	Ambalare
651 0235	1/4"		10/60



6542PP

Priză presiune/temperatură pentru robinetii de echilibrare dinamică

i Pentru robinet 6541CC - 6542CC - 6542CCS - 6538 - 6540

Cod	Dimensiune	Pret €	Ambalare
651 0706	1/4"		20/120



6543CH

Cheie de reglare pentru cartușe cu reglare externă

i Pentru robinet 6542CC - 6542CCS (Green 0 - Green 1 - Green 2) - 6541DN - 6538 - 6540

Cod	Dimensiune	Pret €	Ambalare
651 0708	-		1/10



6545CH

Cheia reglare pentru robinet de echilibrare TM-AUTO DN40-DN50

i Pentru robinet 6542CCS (Green 3)

Cod	Dimensiune	Pret €	Ambalare
651 0870	-		1/10



6542ATT

Servomotor electrotermic pentru robinet de echilibrare TIEMME-AUTO. Conexiune M30x1.5

i Pentru robinet 6542CCS (Green 0 - Green 1 - Green 2) - 6540

Cod	Dimensiune	Pret €	Ambalare
651 0814	NC; on/off (230 Vac)		1/10
651 0815	NC; on/off (24 Vac)		1/10
651 0816	NC; 0÷10V (24 Vac)		1/10

La cerere



6542SERV

Servomotor electric pentru robinet de echilibrare TIEMME-AUTO. Conexiune M30 x 1,5

i Pentru robinet 6542CCS (Green 0 - Green 1 - Green 2)

Cod	Dimensiune	Pret €	Ambalare
651 0817	2 pozitii, reglare în 3 puncte (230 V AC)		1/10
651 0819	0-10 V (24V AC)		1/10



6542SERV2

Servomotor electric pentru supapa de echilibrare TIEMME-AUTO DN40 - DN50. Conexiune M30 x 1,5

i Pentru robinet 6542CCS (Green 3)

Cod	Dimensiune	Pret €	Ambalare
651 0818	Reglare 0-10 V în 2 pozitii, în 3 puncte (24 V AC)		1/10



6536

Manometru diferential digital T550 pentru masurarea presiunii diferentiale și calcularea debitului

Cod	Dimensiune	Pret €	Ambalare
651 0237	-		1/5

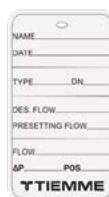

6535ET

Eticheta pentru înregistrarea datelor de setare a robinetului

i Furnizata cu inelul metalic de prindere

Cod	Dimensiune	Pret €	Ambalare
651 0236	-		10/100





3135N

Filtru cu autocuratare cu set de prindere, racorduri exterioare tip olandez M/M

CARACTERISTICI TEHNICE:

- Grad de filtrare: 100 µm
- Materialul paharului colector: policarbonat transparent
- Corp: din alama CW 617N nichelat
- Presiune maxima de exercitiu: 16 bar
- Temperatura maxima de exercitiu: 65°C
- Filete interioare: M/M ISO 228
- Livrat cu manometru si robinet de golire

Cod	Dimensiune	Pret €	Ambalare
313 0002	1/2"		1/14
313 0006	3/4"		1/14
313 0005	1"		1/14
313 0011	1"1/4		1/14



3130N

Filtru cu autocuratare cu set de prindere, racorduri exterioare tip olandez M/M

CARACTERISTICI TEHNICE:

- Grad de filtrare: 100 µm
- Materialul paharului colector: alama CW 617N
- Corp: din alama CW 617N nichelat sau galben
- Presiune maxima de exercitiu: 25 bar
- Temperatura maxima de exercitiu: 95°C
- Filete interioare: M/M ISO 228
- Livrat cu manometru si robinet de golire

 Disponibil si in varianta galbena

Cod	Dimensiune	Pret €	Ambalare
313 0001	1/2"		1/14
313 0003	3/4"		1/14
313 0004	1"		1/14
313 0009	1"1/4		1/14



3136N

Filtru cu autocuratare cu iesiri F/M

CARACTERISTICI TEHNICE:

- Grad de filtrare: 100 µm
- Materialul paharului colector: policarbonat transparent
- Corp: din alama CW 617N nichelat
- Presiune maxima de exercitiu: 16 bar
- Temperatura maxima de exercitiu: 65°C
- Filete interioare: F/M ISO 228
- Livrat cu manometru si robinet de golire

Cod	Dimensiune F M	Pret €	Ambalare
313 0017	1/2" x 3/4"		1/14
313 0012	3/4" x 1"		1/14
313 0015	1" x 1"1/4		1/14
313 0020	1"1/4 x 1"1/2		1/14



3131N

Filtru cu autocuratare cu iesiri F/M

CARACTERISTICI TEHNICE:

- Grad de filtrare: 100 µm
- Materialul paharului colector: alama CW 617N
- Corp: din alama CW 617N nichelat sau galben
- Presiune maxima de exercitiu: 25 bar
- Temperatura maxima de exercitiu: 95°C
- Filete interioare: F/M ISO 228
- Livrat cu manometru si robinet de golire

 Disponibil si in varianta galbena

Cod	Dimensiune F M	Pret €	Ambalare
313 0007	1/2" x 3/4"		1/14
313 0008	3/4" x 1"		1/14
313 0010	1" x 1"1/4		1/14
313 0014	1"1/4 x 1"1/2		1/14



3120N
Filtru cu autocuratare cu iesiri F/F

CARACTERISTICI TEHNICE:

- Grad de filtrare: 100 µm
- Materialul paharului colector: alama CW 617N
- Corp: din alama CW 617N nichelat
- Presiune maxima de exercitiu: 16 bar
- Temperatura maxima de exercitiu: 95°C
- Filete interioare: F/F ISO 228
- Livrat cu 2 manometre si robineti de golire

Cod	Dimensiune	Pret €	Ambalare
313 0018	1"1/2		1/6
313 0016	2"		1/8



3145
Kit olandezi pentru filtre cu autocuratare art. 3131-3136

Cod	Dimensiune	Pret €	Ambalare
313 0024	1/2" - 3/4"		1/50
313 0021	3/4" - 1"		1/40
313 0023	1" - 1"1/4		1/30
313 0025	1"1/4 - 1"1/2		1/20



3140
Cartus de schimb pentru filtre cu autocuratare

Cod	Dimensiune	Pret €	Ambalare
313 0013	1/2" - 3/4"		1/50
313 0019	1" - 1"1/4		1/50

3135N - 3130N

OPTIUNI DE ASAMBLARE

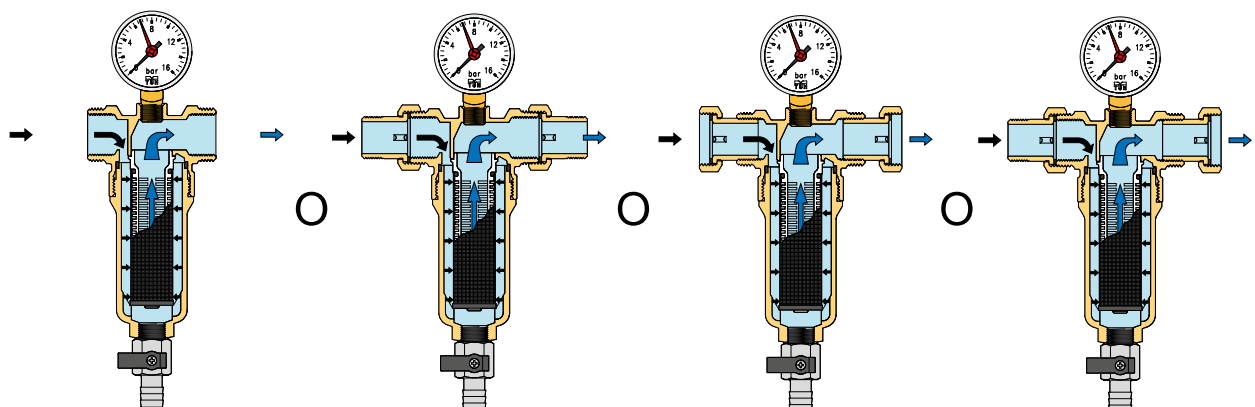

Fara semiolandez si piulita libera

Cu olandez si piulita libera M/M

Cu olandez si piulita libera F/F

Cu olandez si piulita libera M/F





3670
Filtru de impuritati tip "Y"

CARACTERISTICI TEHNICE:

- Grad de filtrare: de la 350 µm la 600 µm in functie de diametru
- Corp: din alama CW 617N
- Presiune maxima de exercitiu: 20 bar pana la 2"; peste 2" 16 bar cealalate
- Temperatura maxima de exercitiu: 100°C
- Filete interioare: F/F ISO 228

Cod	Dimensiune	Pret €	Ambalare
367 0003	1/2"		20/80
367 0001	3/4"		18/54
367 0002	1"		10/30
367 0005	1"1/4		4/16
367 0009	1"1/2		3/12
367 0004	2"		2/8
367 0011	2"1/2		1/8
367 0014	3"		1/5
367 0015	4"		1/1

Capac cu orificiu pentru etansare



3100N

Reductor de presiune cu iesiri F/F

CARACTERISTICI TEHNICE:

- Domeniu de reglare: 1-4 bar (presetat 3 bar)
- Presiune maxima in amonte: 15 bar
- Temperatura maxima de exercitiu: 80°C
- Corp: din alama CW 617N nichelat
- Filete interioare: F/F ISO 228
- Racord pentru manometru: 1/4"F

Cod	Dimensiune	Pret €	Ambalare
318 0021	3/8"		1/50
318 0057	1/2"		1/25
318 0058	3/4"		1/25

Până la terminarea stocului



3110N

Reductor de presiune cu piston si iesiri F/F

CARACTERISTICI TEHNICE:

- Domeniu de reglare: 1-6 bar (presetat 3 bar)
- Presiune maxima in amonte: 25 bar
- Temperatura maxima de exercitiu: 80°C
- Corp: din alama CW 617N nichelat
- Filete interioare: F/F ISO 228
- Racord pentru manometru: 1/4"F

Cod	Dimensiune	Pret €	Ambalare
318 0008	1/2"		1/10
318 0010	3/4"		1/10
318 0003	1"		1/8
318 0012	1"1/4		1/8
318 0014	1"1/2		1/8
318 0009	2"		1/8
318 0016	2"1/2		1/2
318 0015	3"		1/1
318 0006	4"		1/1



3108N

Reductor de presiune cu piston si racorduri olandez M/M (Presiune maxima in amonte 25bar, domeniu de reglare 1-6 bar si presetat 3 bar)

CARACTERISTICI TEHNICE:

- Domeniu de reglare: 1-6 bar (presetat 3 bar)
- Presiune maxima in amonte: 25 bar
- Temperatura maxima de exercitiu: 80°C
- Corp: din alama CW 617N nichelat
- Filete interioare: M/M ISO 228
- Racord pentru manometru: 1/4"M

Cod	Dimensiune	Pret €	Ambalare
318 0068	1/2"		1/10
318 0069	3/4"		1/10
318 0070	1"		1/8
318 0071	1"1/4		1/8
318 0072	1"1/2		1/4
318 0075	2"		1/4



3107N

Reductor de presiune cu piston si racorduri olandez F/F

CARACTERISTICI TEHNICE:

- Domeniu de reglare: 1-6 bar (presetat 3 bar)
- Presiune maxima in amonte: 25 bar
- Temperatura maxima de exercitiu: 80°C
- Corp: din alama CW 617N nichelat
- Filete interioare: F/F ISO 228
- Racord pentru manometru: 1/4"F

Cod	Dimensiune	Pret €	Ambalare
318 0002	1/2"		1/10
318 0004	3/4"		1/10
318 0011	1"		1/8
318 0019	1"1/4		1/8
318 0020	1"1/2		1/4
318 0018	2"		1/4





3180

Reductor de presiune cu iesiri F/F

CARACTERISTICI TEHNICE:

- Domeniu de reglare: 1-6 bar (presetat 3 bar)
- Presiune maxima in amonte: 16 bar
- Temperatura maxima de exercitiu: 65°C
- Corp: din alama CW 617N nichelat
- Filete interioare: F/F ISO 7/EN 10226
- Racord pentru manometru: 1/4"F

i Pentru cartus de înlocuire vezi 3180C

Cod	Dimensiune	Pret €	Ambalare
318 0017	1/2"		1/10
318 0013	3/4"		1/10



2080

Manometru cu prindere radiala DN50

Cod	Dimensiune	Scara	Pret €	Ambalare
318 0007	1/4"	0 - 6 bar		5/25
318 0025	1/4"	0 - 16 bar		5/25



2080POST

Manometru cu atac posterior



Cod	Dimensiune	Scara	Pret €	Ambalare
192 0017	1/4"	0 - 10 bar		1/40

**4737**

Vana termostatica cromata F pentru apa calda

CARACTERISTICI TEHNICE:

- Conform cu: UNI EN 1111
- Interval de temperatură: 30÷55°C
- Presiune maximă de lucru: 10 bar
- Temperatura maximă de intrare: 90°C
- Material corp: alamă CW617N
- Material capac: PA
- Debit la 3 bar: 30 l/min

Cod	Dimensiune	Pret €	Ambalare
320 0038	1/2"		1/10
320 0037	3/4"		1/10

**4739**

Vana termostatica cromata, racorduri exterioare tip olandez M/M, pentru apa calda

CARACTERISTICI TEHNICE:

- Conform cu: UNI EN 1111
- Interval de temperatură: 30÷55°C
- Presiune maximă de lucru: 10 bar
- Temperatura maximă de intrare: 90°C
- Material corp: alamă CW617N
- Material capac: PA
- Debit la 3 bar: 30 l/min

Cod	Dimensiune	Pret €	Ambalare
320 0039	1/2"		1/10
320 0040	1/2" cu supapă de reținere		1/10

**4738**

Vana de amestec 1" M pentru centrale termice

CARACTERISTICI TEHNICE:

- In conformitate cu Norma Europeana EN 1111
- Corp: din alama CW 602N cromat
- Câmp de reglare a temperaturii: 30 - 55°C
- Temperatura maxima de exercitiu: 10 bar
- Temperatura maxima apa calda: 90°C
- Debit la 3 bar: 72 l/min

Cod	Dimensiune	Pret €	Ambalare
320 0036	3/4"		1/10
320 0001	1"		1/10

**4738KIT01**

Kit semiolandezi pentru vana de amestec 4738

i Setul include: 3 stuturi, 3 piulițe, 3 garnituri

Cod	Dimensiune	Pret €	Ambalare
Pentru 4738 (3/4")			
470 0454	3/4" x 1/2"		1/10
470 0455	3/4" x 1/2" cu supapă de reținere		1/10
470 0475	3/4" x 3/4"		1/10
470 0474	3/4" x 3/4" cu supapă de reținere		1/10
Pentru 4738 (1")			
470 0190	1" x 3/4"		1/10
470 0191	1" x 3/4" cu supapă de reținere		1/10
470 0192	racord din cupru Ø22 compresie		1/10

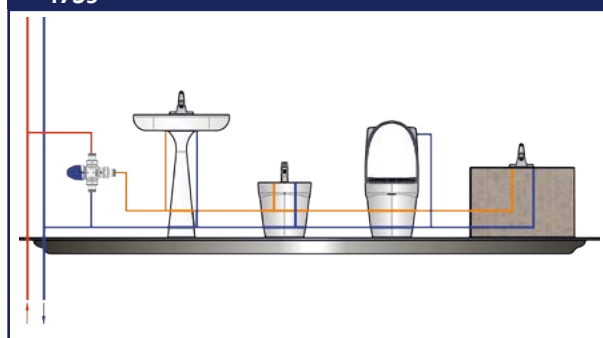
**4737-4738
4739****EXEMPLE DE INSTALARE**

**4738KR**

Kit termostatic anti-oparire cu pompa de recirculare

CARACTERISTICI TEHNICE:

- Vana amestec in conformitate cu: UNI EN 1111
- Câmp temperatura: 30÷55°C
- Temperatura maxima de functionare: 90°C
- Presiune maxima de functionare: 10bar

Cod	Dimensiune	Pret €	Ambalare
320 0002	30÷55°C		1/1

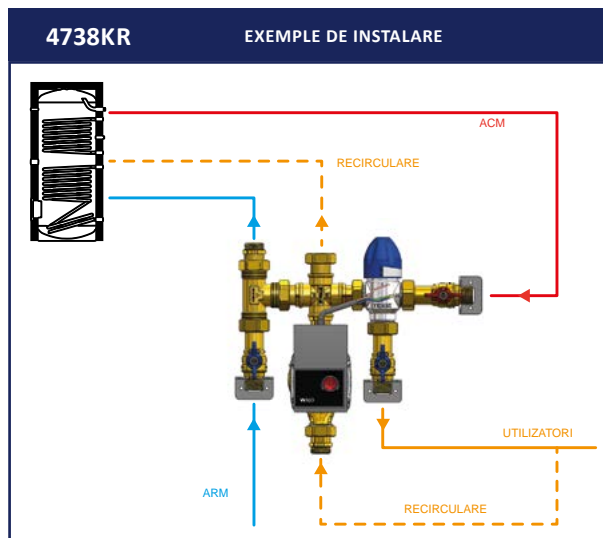



1935
Amortizor lovitura de berbec

CARACTERISTICI TEHNICE:

- Corp: alama CW617N cromata
- Amortizor: polimer cu rezistenta ridicata
- Arc: otel
- Garnituri: EPDM
- Fluidul utilizat: apa
- Presiune max de exercitiu: 10 bar
- Temperatura max a fluidului: 110°C
- Presiune max lovitura de berbec: 50 bar
- Pornire interventie activa: 3 bar
- Racorduri: 1/2" M cu garnitura EPDM

Cod	Dimensiune	Pret €	Ambalare
194 0001	1/2"		1/25

1935

EXEMPLE DE INSTALARE

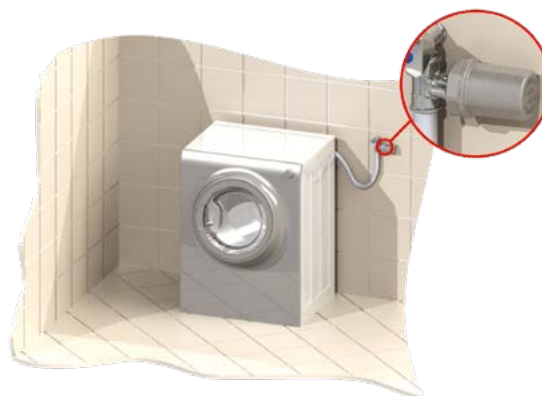



3501

Vana anti-retur cu camera de joasa presiune controlata tip BA

CARACTERISTICI TEHNICE:

- Filet ISO 228
- Material corp: alama CW602N (1/2" - 3/4"); Bronz (> 1")
- Tip BA conform standardului EN 1717
- Împotriva riscurilor de contaminare cu apă până la categoria 4

Cod	Dimensiune	Pret €	Ambalare
350 0296	1/2"		1/1
350 0297	3/4"		1/1
350 0298	1"		1/1
350 0299	1"1/4		1/1
350 0300	1"1/2		1/1
350 0301	2"		1/1

3501

GHID DE INSTALARE

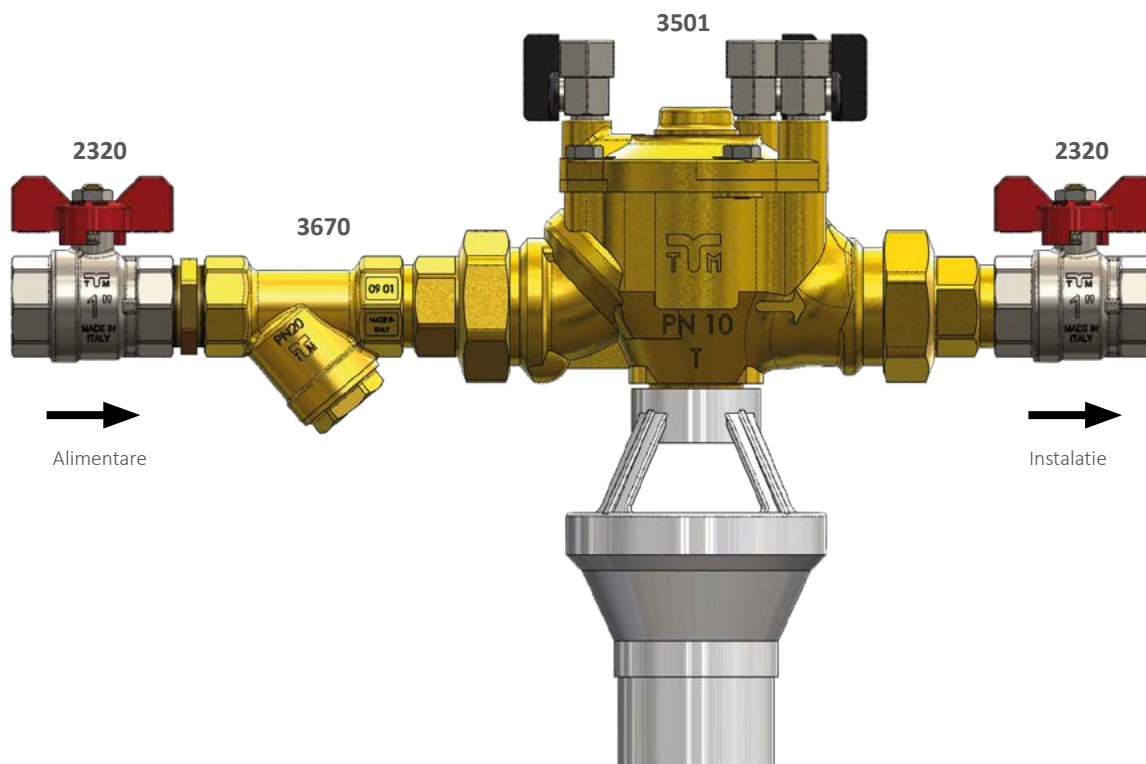

16 SISTEM SOLAR TERMIC CU CIRCULATIE FORTATA PENTRU PRODUCEREA APEI CALDE MENAJERE

Grupuri hidraulice pentru sistemele solare termice  362

Accesorii pentru sistemele solare termice  364

Componente pentru sisteme solare termice  366

Fitinguri cu cuplare rapida "COBRASUN" pentru teava ondulata din otel inoxidabil  371

Racorduri cu prindere rapida "EASYSOLAR"  374

Racorduri pentru teava de cupru si tubul ondulat de otel inox  376

Tub ondulat din otel inox preizolat si accesorii pentru instalare  383



ERC

CE

TSU



**4745**

Grup hidraulic dublu pentru sisteme solare termice cu izolatie inclusa. Versiune cu degazator, robinet cu sfera cu termometru incorporat, grup de siguranta 6 bar si debitmetru mecanic

CARACTERISTICI TEHNICE:

- Dimensiune: DN 25 - 1"
- Conexiuni: 3/4" F
- Presiune maxima: 10 bar
- Temperatura max: 160°C
- Material parti metalice: alama CW 617N
- Material garnituri: EPDM Perox; cauciuc fluorurat
- Material izolatie: polipropilena expandata

TUR

- Masurator / regulator de debit special pentru temperaturi ridicate
- Grup de incarcare / descarcare
- Pompa de circulatie
- Vana de amestec cu filet pentru supapa de siguranta, supapă de sens si termometru
- Supapa de siguranta 6 bar cu manometru

RETUR

- Vana de amestec cu supapa de sens si termometru
- Supapa de aerisire (degazator)

Cod	Pompa de circulatie	Debitmetru	Pret €	Ambalare
470 0315	Fara pompa	1÷10 l/min		1/1
470 0319		8÷30 l/min		1/1
470 0408	Grundfos solar UPM3 15/75	1÷10 l/min		1/1
470 0409		8÷30 l/min		1/1
470 0379	Wilo Para ST 15/7.0	1÷10 l/min		1/1
470 0380		8÷30 l/min		1/1
470 0232	Grundfos solar 15/65	1÷10 l/min		1/1
470 0233		8÷30 l/min		1/1

ErP READY

Disponibila pentru tari non UE

**4745E**

Grup hidraulic dublu pentru sisteme solare termice cu izolatie inclusa. Versiune cu degazator, robinet cu sfera cu termometru incorporat, grup de siguranta 6 bar si debitmetru electronic (Vortex)

**CARACTERISTICI TEHNICE:**

- Dimensiune: DN 25 - 1"
- Conexiuni: 3/4" F
- Presiune maxima: 10 bar
- Temperatura max: 160°C
- Material parti metalice: alama CW 617N
- Material garnituri: EPDM Perox; cauciuc fluorurat
- Material izolatie: polipropilena expandata

TUR

- Masurator / regulator de debit special pentru temperaturi ridicate
- Grup de incarcare / descarcare
- Pompa de circulatie
- Vana de amestec cu filet pentru supapa de siguranta, supapă de sens si termometru
- Supapa de siguranta 6 bar cu manometru

RETUR

- Vana de amestec cu supapa de sens si termometru
- Supapa de aerisire (degazator)

+ DEBITMETRU ELECTRONIC

Cod	Pompa de circulatie	Debitmetru	Pret €	Ambalare
470 0536	Fara pompa	2÷40 l/min		1/1
470 0410	Grundfos solar UPM3 15/75	2÷40 l/min		1/1
470 0381	Wilo Para ST 15/7.0	2÷40 l/min		1/1

ErP READY



**4745R**

Grup hidraulic pentru sisteme solar termice. Izolatie proiectata pentru a proteja controlerul art. 4735E

CARACTERISTICI TEHNICE:

- Dimensiune: DN 25 - 1"
- Conexiuni: 3/4" F
- Presiune maxima: 10 bar
- Temperatura max: 160°C
- Material parti metalice: alama CW 617N
- Material garnituri: EPDM Perox; cauciuc fluorurat
- Material izolatie: polipropilena expandata

Cod	Pompa de circulatie	Debitmetru	Pret €	Ambalare
470 0539	Fara pompa	1÷10 l/min		1/1
470 0540		8÷30 l/min		1/1
470 0416	Wilo Para ST 15/7.0	1÷10 l/min		1/1
470 0417		8÷30 l/min		1/1
470 0275	Grundfos solar 15/65	1÷10 l/min		1/1
470 0276		8÷30 l/min		1/1

ErP READY

Disponibila pentru tari non UE

**4745TRMF**

Grup solar cu pompa Grundfos, debitmetru cu grup de incarcare 1-10 l/min, cu robineti de sectionare cu termometru, grup de siguranta cu manometru si supapa de siguranta 6 bar, fara degazator, iesiri 3/4" feminin

CARACTERISTICI TEHNICE:

- Dimensiune: DN 25 - 1"
- Conexiuni: 3/4" F
- Presiune maxima: 10 bar
- Temperatura max: 160°C
- Material parti metalice: alama CW 617N
- Material garnituri: EPDM Perox; cauciuc fluorurat
- Material izolatie: polipropilena expandata

TUR

- Masurator / regulator de debit special pentru temperaturi ridicate
- Grup de incarcare / descarcare
- Pompa de circulatie
- Vana de amestec cu filet pentru supapa de siguranta, supapă de sens si termometru
- Supapa de siguranta 6 bar cu manometru

RETUR

- Vana de amestec cu supapa de sens si termometru

Cod	Pompa de circulatie	Debitmetru	Pret €	Ambalare
470 0209	Grundfos solar UPM3 15/65	1÷10 l/min		1/1

ErP READY

**4744**

Grup hidraulic mono braț pentru sisteme solare termice cu izolatie inclusa. Versiune cu robinet cu sfera cu termometru incorporat, grup de siguranta 6 bar si debitmetru mecanic

CARACTERISTICI TEHNICE:

- Dimensiune: DN 25 - 1"
- Conexiuni: 3/4" F
- Presiune maxima: 10 bar
- Temperatura max: 160°C
- Material parti metalice: alama CW 617N
- Material garnituri: EPDM Perox; cauciuc fluorurat
- Material izolatie: polipropilena expandata

TUR

- Masurator / regulator de debit special pentru temperaturi ridicate
- Grup de incarcare / descarcare
- Pompa de circulatie
- Vana de amestec cu filet pentru supapa de siguranta, supapă de sens si termometru
- Supapa de siguranta 6 bar cu manometru

Cod	Pompa de circulatie	Debitmetru	Pret €	Ambalare
470 0437	Fara pompa	1÷10 l/min		1/1
470 0411	Grundfos solar UPM3 15/75	1÷10 l/min		1/1
470 0382	Wilo Para ST 15/7.0	1÷10 l/min		1/1
470 0257	Grundfos solar 15/65	1÷10 l/min		1/1

ErP READY

Disponibila pentru tari non UE

**4735E**

Controler electronic diferential programabil pentru sistemele solare, dotat cu display LCD

Cod	Intrari	Sonde	Iesiri	Pret €	Ambalare
470 0516	3	1	2		1/4
470 0517	4	2	3		1/4
470 0518	6	3	4		1/4

Cu intrare pentru debitmetru electronic art. 4749E - 4749FLOWE

**4745C**

Cadru din PPE pentru reglatoarele electronice

Cod	Dimensiune	Pret €	Ambalare
470 0533	Pentru 470 0516		1/10
470 0286	Pentru 470 0517 - 470 0518		1/10
470 0321	ORB		1/10

4745C

CONFIGURAȚII



470 0533



470 0286



470 0321

**4736SONDA**

Sonda de temperatura PT1000, cablu de 2 m siliconat, sonda din oțel 6x25 mm

Cod	Dimensiune	Pret €	Ambalare
470 0027	-		1/50

**4747**

Supapa de aerisire (degazator) pentru grup hidraulic racorduri 3/4" M/M cu O-ring

Cod	Dimensiune	Pret €	Ambalare
470 0057	3/4"		1/20

**4748D**

Grup de siguranta cu manometru 1-10 bar, supapa de siguranta 6 bar

Cod	Dimensiune	Pret €	Ambalare
470 0227	-		1/10

**4749FLOW**

Grup de incarcare / descarcare cu debitmetru mecanic integrat pentru sistemele solare termice

Cod	Dimensiune	Pret €	Ambalare
470 0267	1" F x 3/4" F - 1÷10 l/min		1/5
470 0268	1" F x 3/4" F - 8÷30 l/min		1/5

**4749FLOWE**

Grup de incarcare / descarcare cu debitmetru electronic (Vortex) integrat pentru sistemele solare termice

Cod	Dimensiune	Pret €	Ambalare
470 0269	1" F x 3/4" F - 2÷40 l/min		1/5

+ DEBITMETRU ELECTRONIC

**4749E**

Senzor pentru debitmetru electronic

Cod	Dimensiune	Pret €	Ambalare
470 0272	2÷40 l/min		1/5

**4745MANOP**

Maneta cu termometru de imersie pentru grup hidraulic pentru sistemele solare termice

Cod	Dimensiune	Pret €	Ambalare
470 0183	albastru		10/40
470 0184	rosie		10/40

**4712LPS**

Colector solar plan selectiv pentru montare verticala

**CARACTERISTICI TEHNICE:**

- 2 Suprafata totala a colectorului 2,09 m²
- 2 Suprafata de absorbtie 1,92 m²
- Putere maxima 1.325 W
- Temperatura de stagnare 193 °C
- Absorber ALANOD MIROTHERM

Cod	Dimensiune	Pret €	Ambalare
470 0404	2,09 m ²		1/1

**4722KITFX**

Kit pentru montarea a 1 sau 2 colectoare 4712LPS pe acoperisuri plane sau cu inclinare

Cod	Colectoare	Model	Pret €	Ambalare
470 0405	1 (vert.)	4712LPS		10/40
470 0406	2 (vert.)			10/40

**3890PG4**

Pompa de înalta eficienta GRUNDFOS UPM3 SOLAR PM 15/75 cu comanda PWM si interaxa 130 mm

+ POMPE DE INALTA EFICIENTA

Cod	Dimensiune	Pret €	Ambalare
470 0407	Grundfos Solar UPM3 15/75-130		1/1

**3890PW4**

Pompa Wilo Para ST 15/7.0 cu randament mare si comanda PWM. Racorduri 1" si interaxa 130 mm

+ POMPE DE INALTA EFICIENTA

Cod	Dimensiune	Pret €	Ambalare
470 0378	Wilo Para ST 15/7.0		1/1

**3890PG3**

Pompa cu 3 viteze pentru instalatii solare Grundfos Solar 15/65

Cod	Dimensiune	Pret €	Ambalare
470 0224	Grundfos solar 15/65		1/1

Disponibila pentru tari non UE

**2330SUN**

Robinet cu sfera F/F cu maneta de culoare portocalie. Temperatura maxima 180 °C

Cod	Dimensiune	Pret €	Ambalare
472 0012	1/2"		25/100
472 0008	3/4"		15/60
472 0015	1"		10/40

**2162SUN**

Robinet cu capete cupru cu maneta de culoare portocalie. Temperatura maxima 180°C

Cod	Dimensiune	Pret €	Ambalare
472 0074	15		15/60
472 0075	18		15/60
472 0076	22		10/40
472 0077	28		7/28

**2331SUN**

Robinet cu sfera M/F cu maneta de culoare portocalie. Temperatura maxima 180 °C

Cod	Dimensiune	Pret €	Ambalare
472 0018	1/2"		25/100
472 0010	3/4"		15/60
472 0014	1"		10/40

**2371SUN**

Robinet cu sfera M/F cu maneta tip fluture de culoare portocalie. Temperatura maxima 180 °C

Cod	Dimensiune	Pret €	Ambalare
472 0007	1/2"		25/100

**2991SUN**

Robinet cu sfera incarcare/descarcare pentru temperaturi inalte. Racord 1/2" cu O-ring

Cod	Dimensiune	Pret €	Ambalare
472 0019	1/2"		25/100

**3506SUN**

Supapa de sens EUROSTOP F/F ISO228 cu obturator metalic pentru temperaturi inalte

Cod	Dimensiune	Pret €	Ambalare
472 0082	1/2"		15/60
472 0083	3/4"		10/40
472 0084	1"		6/24
472 0085	1"1/4		5/20
472 0086	1"1/2		2/8
472 0087	2"		2/8

**1900SUN**

Supapa automata de aerisire cu O-RING. Temperatura maxima 180°C

Cod	Dimensiune	Pret €	Ambalare
472 0001	1/2"		1/50

**1900KITSUN**

Supapa automata de aerisire cu robinet cu sfera. Temperatura maxima 180°C

Cod	Dimensiune	Pret €	Ambalare
472 0004	1/2"		2/20



1917SUN 1927SUN

Supapa de siguranta pentru sistemele solare termice. Temperatura maxima 160°C. Presiune maxima 10 bar (100KPa). Filet feminin ISO 7

Cod	Dimensiune	Tarare	Pret €	Ambalare
472 0089	1/2" x 1/2"	2,5 bar		1/40
472 0080	1/2" x 3/4"	2,5 bar		1/40
472 0011	1/2" 3/4"	3 bar		1/40
472 0006	1/2" 3/4"	6 bar		1/40



3177XSUN

Grup de siguranta pentru boiler si acumulator pentru sisteme solare termice.

Cod	Dimensiune	Tarare	Pret €	Ambalare
319 0018	3/4" x 3/4"	10 bar		1/20

3177XSUN

EXEMPLU DE APLICARE

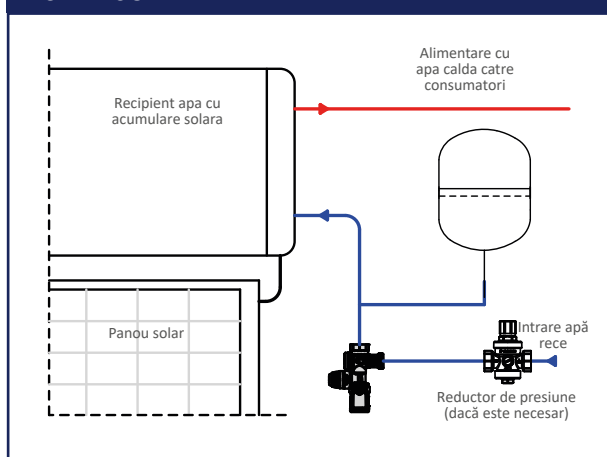

1916SUN

Supapa de siguranta M de temperatura si presiune pentru teava cupru pentru sisteme solare termice.

+ CONTROL TEMPERATURA-PRESIUNE

Cod	Dimensiune	Tarare	Pret €	Ambalare
472 0088	3/4" x 22	10 bar		1/10

**4737SUN**

Vana termostatica cromata F
pentru sistemele solare termice

CARACTERISTICI TEHNICE:

- Conform cu: UNI EN 1111
- Interval de temperatură: 30÷55°C
- Presiune maximă de lucru: 10 bar
- Temperatura maximă de intrare: 100°C
- Material corp: alamă CW617N
- Material capac: PA
- Debit la 3 bar: 30 l/min

Cod	Dimensiune	Pret €	Ambalare
470 0456	1/2"		1/10
470 0457	3/4"		1/10

**4739SUN**

Vana termostatica cromata,
racorduri exterioare tip olandeze
M/M, pentru sistemele solare
termice

CARACTERISTICI TEHNICE:

- Conform cu: UNI EN 1111
- Interval de temperatură: 30÷55°C
- Presiune maximă de lucru: 10 bar
- Temperatura maximă de intrare: 100°C
- Material corp: alamă CW617N
- Material capac: PA
- Debit la 3 bar: 30 l/min

Cod	Dimensiune	Pret €	Ambalare
470 0459	1/2"		1/10
470 0460	1/2" cu supapă de reținere		1/10
470 0476	3/4"		1/10
470 0477	3/4" cu supapă de reținere		1/10

**4738SUN**

Vana termostatica cromata M
pentru sistemele solare termice

CARACTERISTICI TEHNICE:

- Conform cu: UNI EN 1111
- Interval de temperatură: 30÷55°C
- Presiune maximă de lucru: 10 bar
- Temperatura maximă de intrare: 100°C
- Material corp: alamă CW617N
- Material capac: PA
- Debit la 3 bar: 30 l/min (3/4") - 72 l/min (1")

Cod	Dimensiune	Pret €	Ambalare
470 0458	3/4"		1/10
470 0188	1"		1/10

**4738KIT**

Kit semiolandezi pentru vana
termostatica 4738

i Setul include: 3 stuturi, 3 piulițe, 3 garnituri

Cod	Dimensiune	Pret €	Ambalare
Pentru 4738SUN (3/4")			
470 0454	3/4" x 1/2"		1/10
470 0455	3/4" x 1/2" cu supapă de reținere		1/10
470 0475	3/4" x 3/4"		1/10
470 0474	3/4" x 3/4" cu supapă de reținere		1/10
Pentru 4738SUN (1")			
470 0190	1" x 3/4"		1/10
470 0191	1" x 3/4" cu supapă de reținere		1/10
470 0192	racord din cupru Ø22 compresie		1/10



**475KIT**

Kit solar deviator/amestec pentru acumulare apa calda menajera

CARACTERISTICI CONSTRUCTIVE

- Corp: CW617N alamă cromată
- Capace de reglare PA

CARACTERISTICI TEHNICE:**SUPAPA DEVIATOR TERMOSTATIC**

- Temperatura maximă de intrare: +100 ° C
- Presiune maximă de lucru: 10 bar
- Presiune diferențială maximă: 2 bar
- Interval de reglare a temperaturii: +30 ÷ +55 ° C
- Setare din fabrică: +45 ° C
- Precizie: ± 2 ° C
- Compatibilitate cu fluide: apă potabilă

MIXER TERMOSTATIC ANTI-OPARIRE

- Temperatura maximă de intrare: +100 ° C
- Presiune maximă de lucru: 10 bar
- Presiune diferențială maximă: 2 bar
- Interval de reglare a temperaturii: +30 ÷ +55 ° C
- Setare din fabrică: +38 ° C
- Precizie: ± 2 ° C
- Compatibilitate cu fluide: apă potabilă
- Debit la 3 bar: 30 l/min.
- Conformitate: UNI EN 1111

Cod	Dimensiune	Pret €	Ambalare
475 0050	3/4"		1/8

**475KITISOL**

Izolatie pentru kit solar 5 cai deviator si vana termostatica de amestec

Cod	Dimensiune	Pret €	Ambalare
470 0463	475KIT		1/8

475KIT**OPERATIUNE**

DIAGRAMA 1: T < Valoare de setare a abaterii



DIAGRAMA 2: T > Valoare de setare a abaterii



**3894VDSUN**

Supapa termostatică de deviere pentru sisteme solare termice.

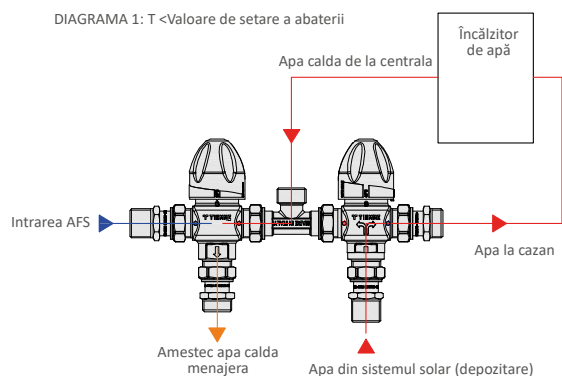
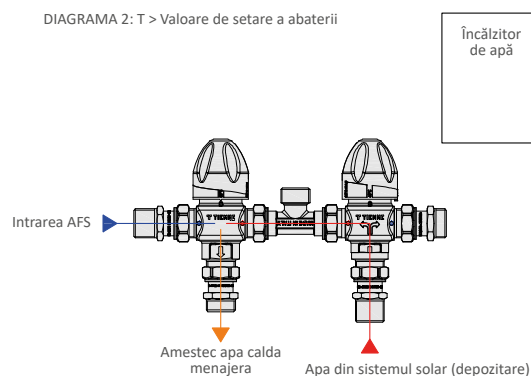
CARACTERISTICI TEHNICE:

- Interval de temperatură: 30 ÷ 55 ° C
- Presiune maximă de lucru: 10 bar
- Presiune diferențială maximă: 2 bar
- Temperatura maximă de intrare: 100 ° C
- Material corp: alamă CW 617N
- Material buton: PA

Cod	Dimensiune	Pret €	Ambalare
470 0453	3/4"		1/10

**2134SUN**

Robinet cu sfera motorizat cu 3 cai – racorduri cu 3 iesiri

Cod	Dimensiune	Aliment.	Pret €	Ambalare
472 0009	3/4"	230 Vac		1/4
472 0013	1"	230 Vac		1/4

**4730V**

Vas de expansiune presetat la 3 bar

Cod	Dimensiune	Pret €	Ambalare
470 0031	18 l		1/1
470 0045	24 l		1/1
470 0066	35 l		1/1
470 0055	50 l		1/1

**4746KIT**

Kit pentru conectarea vasului de expansiune

Cod	Dimensiune	Pret €	Ambalare
470 0041	3/4"		1/10

**4746**

Racord in unghi drept din trei bucati cu supapa dubla de blocare si izolare pentru vasul de expansiune.

Cod	Dimensiune	Pret €	Ambalare
470 0028	3/4" M - 3/4" F		5/50

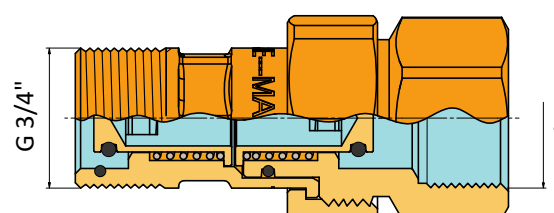
4746 SECȚIUNE**4731ANTIG**

Antigel concentrat pentru sistemele solare

Cod	Litri	Pret €	Ambalare
470 0026	10		1/1





3000X
Racord drept M

 BREVETAT

Cod	Dimensiune	Pret €	Ambalare
071 0102	DN12 x 1/2" M		4/40
071 0082	DN12 x 3/4" M		4/40
071 0036	DN16 x 1/2" M		4/40
071 0037	DN16 x 3/4" M		4/40
071 0038	DN16 x 1" M		4/40
071 0039	DN20 x 3/4" M		4/40
071 0040	DN20 x 1" M		4/40
071 0041	DN25 x 1" M		4/40
071 0042	DN25 x 1"1/4 M		4/40
071 0083	DN32 x 1"1/4 M		4/40
071 0084	DN40 x 1"1/2 M		4/40
071 0085	DN40 x 2" M		4/40



3002X
Racord drept F

 BREVETAT

Cod	Dimensiune	Pret €	Ambalare
071 0103	DN12 x 1/2" F		4/40
071 0087	DN12 x 3/4" F		4/40
071 0050	DN16 x 1/2" F		4/40
071 0051	DN16 x 3/4" F		4/40
071 0052	DN16 x 1" F		4/40
071 0053	DN20 x 3/4" F		4/40
071 0054	DN20 x 1" F		4/40
071 0055	DN25 x 1" F		4/40
071 0088	DN32 x 1"1/4 F		4/40
071 0089	DN40 x 1"1/2 F		4/40
071 0090	DN40 x 2" F		4/40



3001X
Racord drept dublu

 BREVETAT

Cod	Dimensiune	Pret €	Ambalare
071 0086	DN12 x DN12		4/40
071 0043	DN16 x DN16		4/40
071 0044	DN20 x DN20		4/40
071 0045	DN25 x DN25		4/40
071 0165	DN32 x DN32		4/40

 Noutati



3001KB
Racord drept dublu INOX/
CUPRU

 BREVETAT

Cod	Dimensiune	Pret €	Ambalare
071 0130	DN12x12 (Cu)		4/40
071 0166	DN12x16 (Cu)		4/40
071 0046	DN16 x 15 (Cu)		4/40
071 0047	DN16 x 22/18 (Cu)		4/40
071 0048	DN20 x 22/18 (Cu)		4/40
071 0049	DN25 x 22/18 (Cu)		4/40

 Furnizati cu ștuț reducție 22-18

 Noutati



3011X
Racord drept INOX/CUPRU

 BREVETAT

Cod	Dimensiune	Pret €	Ambalare
071 0091	DN16 x Ø 18		4/40
071 0056	DN16 x Ø 22		4/40
071 0092	DN20 x Ø 18		4/40
071 0093	DN20 x Ø 22		4/40
071 0094	DN25 x Ø 18		4/40
071 0095	DN25 x Ø 22		4/40

3004X
Cot M

BREVETAT

Cod	Dimensiune	Pret €	Ambalare
071 0129	DN16 x 3/4" M		4/40

3005X
Cot F

BREVETAT

Cod	Dimensiune	Pret €	Ambalare
071 0078	DN16 x 3/4" F		4/40

3003KB
Cot dublu INOX/CUPRU

BREVETAT

Cod	Dimensiune	Pret €	Ambalare
071 0159	DN12 x 15 (Cu)		4/40
071 0160	DN12 x 18 (Cu)		4/40
071 0133	DN16 x 18 (Cu)		4/40
071 0079	DN16 x 22 (Cu)		4/40

La cerere

3007KB
Teu CUPRU/INOX/CUPRU

BREVETAT

Cod	Dimensiune	Pret €	Ambalare
071 0080	22 (Cu) x DN16 x 22 (Cu)		4/40

3015
Inel

BREVETAT

Cod	Dimensiune	Pret €	Ambalare
071 0104	DN12		50/1000
071 0105	DN16		50/1000
071 0106	DN20		50/1000
071 0107	DN25		50/1000
071 0155	DN32		50/1000

TABEL DE COMPATIBILITATE TUB ONDULAT DIN OTEL INOXIDABIL

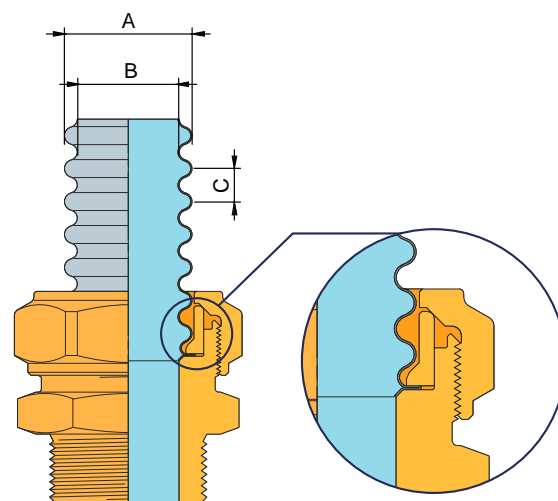

IN TABELUL DE MAI JOS SUNT TRECUTE DIMENSIUNILE DE TEAVA RECOMANDATE:

DN*	A	B	C
12	16,5 ± 0,10	12,5 ± 0,50	4 ± 0,50
16	21,4 ± 0,20	16,8 ± 0,50	5 ± 0,50
20	26,4 ± 0,20	20,8 ± 0,50	5 ± 0,50
25	31,7 ± 0,25	25,5 ± 0,50	5 ± 0,50
32	40,7 ± 0,35	35 ± 0,50	5 ± 0,70
40	49 ± 0,45	40,5 ± 0,50	6,5 ± 0,70

*Pentru alte diametre, contactati departamentul nostru tehnic.

TUTORIAL VIDEO



GHID DE INSTALARE



LISTA DE PRETURI

GHID DE INSTALARE

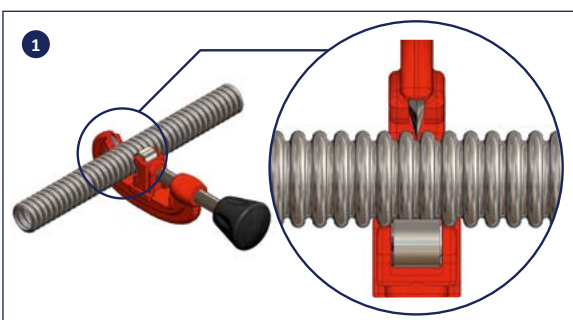

1
 Pozitionati lama in onduleu, perpendicular pe tub.
 Tăietura trebuie să fie curată, fără bavuri

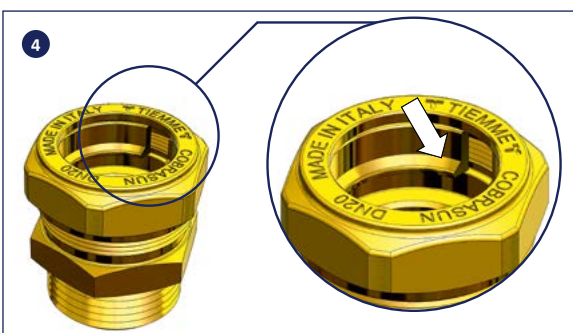

3
 4
 Nu demontati racordul. In cazul dezasamblarii accidentale, trebuie avut grija ca, in momentul reasamblarii șaiba sa fie pozitionata cu fata plana in interiorul niplului.

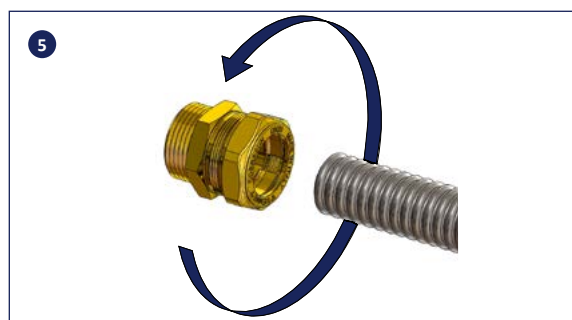

5
 Slabiti manual piulita cu o jumatate de rotatie, in cazul in care nu este deja slabita (fig.5)

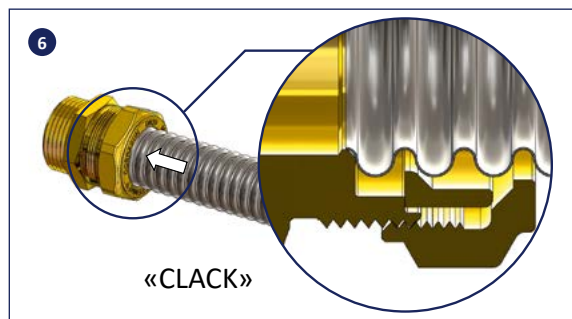

6
 Impingeti tubul in racord pana se aude "CLACK" (fig. 6)

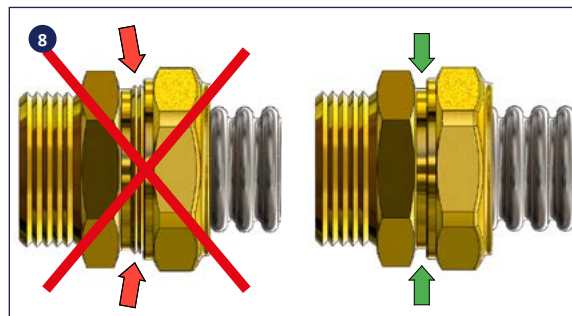
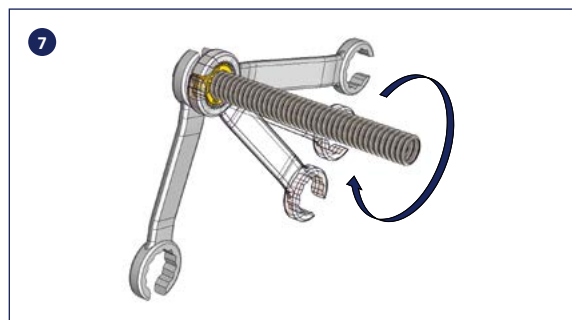

8



3200X
Racord drept M

Cod	Dimensiune	Pret €	Ambalare
071 0057	DN16 x 1/2" M		4/40
071 0058	DN16 x 3/4" M		4/40
071 0059	DN16 x 1" M		4/40
071 0060	DN20 x 3/4" M		4/40
071 0061	DN20 x 1" M		4/40
071 0062	DN25 x 1" M		4/40
071 0063	DN25 x 1"1/4 M		4/40



3202X
Racord drept F

Cod	Dimensiune	Pret €	Ambalare
071 0071	DN16 x 1/2" F		4/40
071 0072	DN16 x 3/4" F		4/40
071 0073	DN16 x 1" F		4/40
071 0074	DN20 x 3/4" F		4/40
071 0075	DN20 x 1" F		4/40
071 0096	DN25 x 3/4" F		4/40
071 0076	DN25 x 1" F		4/40



3201X
Racord drept dublu

Cod	Dimensiune	Pret €	Ambalare
071 0064	DN16 x DN16		4/40
071 0065	DN20 x DN20		4/40
071 0066	DN25 x DN25		4/40



3201KB
Racord drept dublu INOX/
CUPRU

Cod	Dimensiune	Pret €	Ambalare
071 0067	DN16 x 15 (Cu)		4/40
071 0068	DN16 x 22/18 (Cu)		4/40
071 0069	DN20 x 22/18 (Cu)		4/40
071 0070	DN25 x 22/18 (Cu)		4/40

Furnizati cu ștuț reducție 22-18



3211X
Racord drept INOX/tub cilindric

Cod	Dimensiune	Pret €	Ambalare
071 0097	DN16 x Ø 18		4/40
071 0077	DN16 x Ø 22		4/40
071 0098	DN20 x Ø 18		4/40
071 0081	DN20 x Ø 22		4/40
071 0100	DN25 x Ø 18		4/40
071 0101	DN25 x Ø 22		4/40



3204X
Cot M

Cod	Dimensiune	Pret €	Ambalare
071 0035	DN16 x 1/2" M		5/75



3205X
Cot F

Cod	Dimensiune	Pret €	Ambalare
071 0148	DN16 x 1/2" F		5/75
071 0033	DN16 x 3/4" F		5/75



**3203KB**

Cot dublu INOX/CUPRU

Cod	Dimensiune	Pret €	Ambalare
071 0032	DN16 x 22 (Cu)		5/75

TABEL DE COMPATIBILITATE TUB ONDULAT DIN OTEL INOXIDABIL

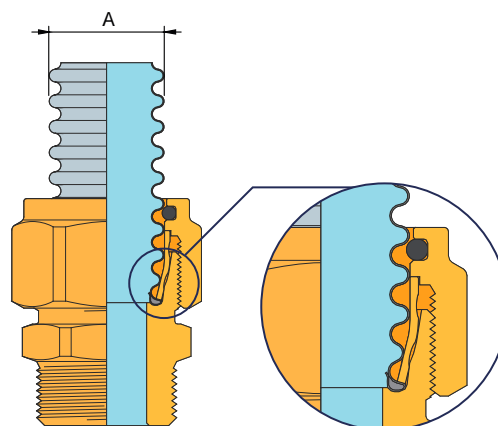

IN TABELUL DE MAI JOS SUNT TRECUTE DIMENSIUNILE DE TEAVA RECOMANDATE:

DN*	A
16	21,4 ± 0,2
20	26,4 ± 0,2
25	31,7 ± 0,25

*Pentru alte diametre, contactati departamentul nostru tehnic.

GHID DE INSTALARE

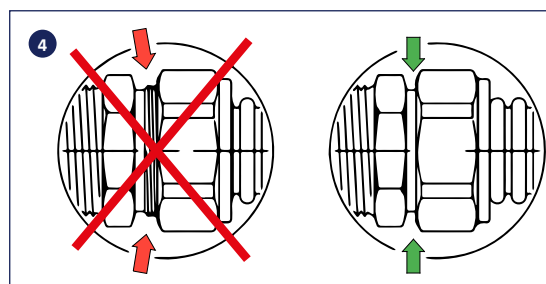
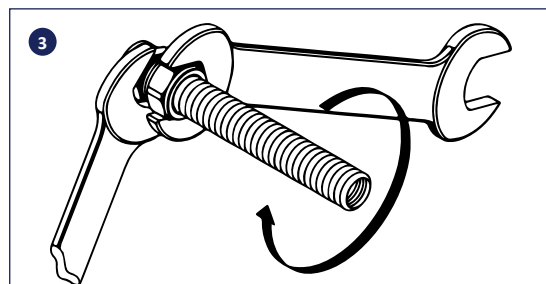
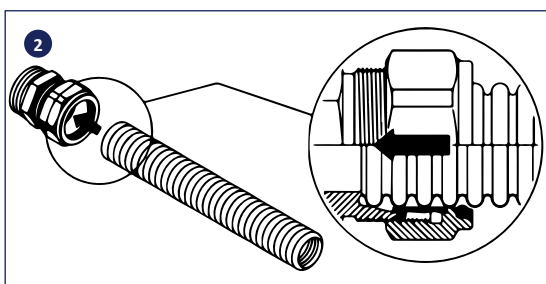
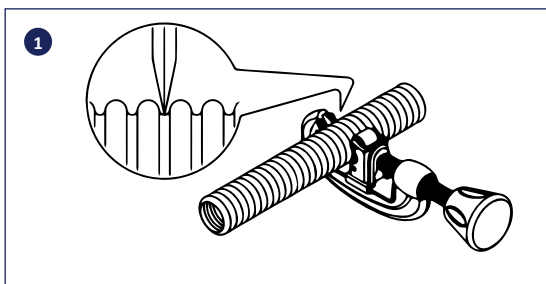

KIT PENTRU CONECTAREA TEVII ONDULATE DE OTEL INOX LA ARMATURI CU FILET MASCULIN FATA PLANA

DESCRIERE

Seturile de conectare art. 1552SET și 8930SET permit o conectare ușoară și rapidă a țevii ondulate din oțel inoxidabil la fittingurile cu filet masculin cu fata plana. Vedeți gama de fittinguri compatibile (marcate cu nota FATA PLANA) prezentată în paginile următoare.

Fittingurile pentru țevi din cupru din seria 1100FD, prin utilizarea kit-ului corespunzător, permit conectarea directă a țevii de cupru/țevă ondulată din oțel inoxidabil, asigurând versatilitate și flexibilitate maximă de instalare.

INSTRUCȚIUNI PENTRU ETANSAREA TUBULUI



1 Introduceți piulița și inelul pe țeva ondulată și înșurubați piulița mamă pe fittingul cu filet masculin pe scaunul plat.

2 Deșurubați piulița de la fittingul cu filet exterior. Verificați locașul plat de pe țeva ondulată.

3 Introduceți garnitura plată și cuplați piulița.

COMPATIBILITATE PENTRU CUPLAREA TUB-RACORD



Teava de oțel corugat	Măsurile racord
DN12	1/2"
DN16	3/4"
DN20	1"
DN25	1" 1/4



1552SET

Set conectare tuburi din oțel, compus din: 4 piulite, 4 garnituri plate, 4 inele pentru prinderea piulitei pe tub, 2 niple

Cod	Dimensiune	Filet	Pret €	Ambalare
071 0128	DN12	1/2"		1/50
071 0001	DN16	3/4"		1/50
071 0003	DN20	1"		1/25
071 0005	DN25	1" 1/4		1/20



8930IM

Piulita de strangere pentru tuburi ondulate de oțel

Cod	Dimensiune	Pret €	Ambalare
071 0109	1/2"		10/500
071 0007	3/4"		10/300
071 0012	1"		10/200
071 0014	1" 1/4		10/100



8930SET

Set pentru instalarea tuburilor din oțel ondulat, compus din: 4 piulite, 4 garnituri plate, 4 inele pentru strangerea piulitei pe tub

Cod	Dimensiune	Filet	Pret €	Ambalare
071 0126	DN12	1/2"		1/150
071 0002	DN16	3/4"		1/150
071 0004	DN20	1"		1/100
071 0011	DN25	1" 1/4		1/50



9341SET

Set garnitura plata si inel pentru tuburi ondulate din oțel

Cod	Dimensiune	Pret €	Ambalare
071 0108	DN12		10/500
071 0008	DN16		10/500
071 0009	DN20		10/500
071 0013	DN25		10/500

**1100FD**

Racord drept piulita si inel pentru teava de cupru, filet masculin, fata dreapta pentru tubul ondulat din otel si garnitura plata

GARNITURA PLATA

Cod	Dimensiune	Pret €	Ambalare
471 0023	15 x 1/2"		10/100
471 0010	15 x 3/4"		5/100
471 0048	16 x 1/2"		10/100
471 0026	18 x 1/2"		10/100
471 0009	18 x 3/4"		5/100
471 0065	18 x 1"		5/100
471 0066	22 x 1/2"		5/100
471 0001	22 x 3/4"		5/100
471 0007	22 x 1"		5/75
471 0042	28 x 1" 1/4		1/50

**1102FD**

Racord drept piulita si inel pentru teava de cupru, filet feminin, fata dreapta

Cod	Dimensiune	Pret €	Ambalare
471 0054	18 x 1/2"		10/100
471 0044	22 x 1/2"		5/100
471 0062	22 x 3/4"		5/100
471 0055	22 x 1"		5/50

**1001
1101**

Conector pentru teava de cupru

Cod	Dimensiune	Pret €	Ambalare
100 0004	15 x 15		10/100
110 0116	16 x 16		10/100
110 0005	18 x 18		10/100
100 0001	22 x 22		5/75
100 0032	28 x 28		5/50

**1552FD**

Niplu fata dreapta si garnitura plata pentru tubul ondulat din otel inox

GARNITURA PLATA

Cod	Dimensiune	Pret €	Ambalare
471 0052	3/8" x 3/8"		25/100
471 0030	1/2" x 1/2"		10/100
471 0003	3/4" x 3/4"		10/100
471 0017	1" x 1"		5/100
471 0085	1" 1/4 x 1" 1/4		5/50
471 0086	1" 1/2 x 1" 1/2		2/30
471 0019	3/4" x 1/2"		10/100
471 0005	1" x 3/4"		5/100
471 0035	1" 1/4 x 1"		5/50
471 0039	1" 1/2 x 1" 1/4		5/50
471 0056	2" x 1" 1/2		2/30

**1552FDR**

Niplu cu fata dreapta la un capat si O-ring la celalalt

GARNITURA PLATA

Cod	Dimensiune	Pret €	Ambalare
471 0004	3/4" x 3/4"		10/100
471 0046	1" x 3/4"		5/100

**1551FD**

Racord drept M/F cu fata dreapta pentru tubul ondulat din otel si garnitura plata

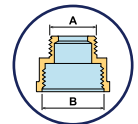

GARNITURA PLATA

Cod	Dimensiune		Pret €	Ambalare
	A	B		
471 0078	3/4" - 1"			10/100

**1581FD**

Reductie M/F cu garnitura plata

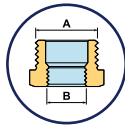

+ GARNITURA PLATA

Cod	Dimensiune		Pret €	Ambalare
	A	B		
471 0050	1/2"	3/8"		25/100
471 0022	3/4"	1/2"		10/100
471 0079	1"	1/2"		10/100
471 0012	1"	3/4"		10/100
471 0038	1"	1/4 x 1"		5/50
471 0043	1"1/2	1" 1/4		5/50
471 0072	2"	1"1/2		2/40

**1553FD**

Racord drept de legatura teava cupru / tub ondulat din otel

+ GARNITURA PLATA

Cod	Dimensiune	Pret €	Ambalare
471 0057	Ø 15 - 3/4"		5/100
471 0016	Ø 22 - 3/4"		5/100
471 0036	Ø 22 - 1"		5/100

**1104FD**

Cot piulita si inel pentru teava de cupru, filet masculin, fata dreapta pentru tubul ondulat din otel si garnitura plata

+ GARNITURA PLATA

Cod	Dimensiune	Pret €	Ambalare
471 0021	15 x 3/4"		5/75
471 0059	16 x 3/4"		5/75
471 0006	18 x 3/4"		5/75
471 0002	22 x 3/4"		5/75
471 0032	22 x 1"		5/50

**1005
1105**

Cot feminin piulita si inel pentru teava de cupru

Cod	Dimensiune	Pret €	Ambalare
100 0016	15 x 1/2"		10/100
100 0067	15 x 3/4"		5/75
110 0138	16 x 1/2"		10/100
110 0018	18 x 3/4"		5/75
100 0017	22 x 3/4"		5/75
100 0053	22 x 1"		5/50

**1003
1103**

Cot conector pentru teava de cupru

Cod	Dimensiune	Pret €	Ambalare
100 0002	15 x 15		10/100
110 0144	16 x 16		10/100
110 0003	18 x 18		10/100
100 0054	22 x 15		5/100
110 0056	22 x 18		5/75
100 0003	22 x 22		5/75
100 0148	28 x 22		5/50
100 0015	28 x 28		5/25

**1133**

Cot dublu tub din cupru/tub pex

Cod	Dimensiune	Pret €	Ambalare
471 0103	18 (Cu)/18 x 2,5 (Pex)		5/100
471 0067	22 (Cu)/18 x 2,0 (Pex)		5/100
471 0027	22 (Cu)/18 x 2,5 (Pex)		5/100
471 0008	22 (Cu)/22 x 3,0 (Pex)		5/100



**1564FD**

Cot M cu piulita libera si garnitura plata

 GARNITURA PLATA

Cod	Dimensiune	Pret €	Ambalare
150 0520	3/4" x 3/4"		5/50

**1039****1139**

Teu F

Cod	Dimensiune	Pret €	Ambalare
100 0062	15 x 15 x 1/2"		10/100
110 0115	18 x 18 x 1/2"		5/70
100 0022	22 x 22 x 1/2"		5/60

**1007****1107**

Teu pentru tub din cupru

Cod	Dimensiune			Pret €	Ambalare
	1	2	3		
100 0005	15	15	15		10/100
100 0133	15	22	15		5/50
110 0166	16	16	16		10/80
110 0032	18	18	18		5/50
100 0086	22	15	15		5/50
100 0020	22	15	22		5/50
100 0056	22	22	15		5/50
100 0013	22	22	22		5/50
100 0212	22	28	22		5/25
100 0108	28	15	28		5/25
100 0174	28	22	22		5/25
100 0103	28	22	28		5/25
100 0189	28	28	15		5/25
100 0183	28	28	22		5/25
100 0060	28	28	28		5/25

**1138**

Teu tub din cupru/tub Pex/tub din cupru

Cod	Dimensiune	Pret €	Ambalare
471 0037	22 (Cu)/18 x 2,5 (Pex)/22(Cu)		5/50
471 0025	22 (Cu)/22 x 3,0 (Pex)/22(Cu)		5/50

**1572FD**

Teu masculin cu fata dreapta pentru tubul ondulat de otel si garnitura plata

 GARNITURA PLATA

Cod	Dimensiune			Pret €	Ambalare
	1	2	3		
471 0020	1/2"	1/2"	1/2"		10/100
471 0040	3/4"	1/2"	1/2"		5/75
471 0041	3/4"	1/2"	3/4"		5/75
471 0060	3/4"	3/4"	1/2"		5/75
471 0011	3/4"	3/4"	3/4"		5/75
471 0049	1"	3/4"	1"		5/50
471 0084	1"	1"	1"		5/50



1878
Dop M

Cod	Dimensiune	Pret €	Ambalare
150 0273	3/8"		25/200
150 0040	1/2"		25/300
150 0019	3/4"		10/150
150 0077	1"		10/100
150 0222	1" 1/4		5/100
150 0865	1" 1/2		5/50
150 0866	2"		2/40



1035
1135
Dop pentru tub din cupru

Cod	Dimensiune	Pret €	Ambalare
100 0028	15		10/350
110 0027	18		10/220
100 0012	22		5/150
100 0098	28		5/100



1116
Stut de ranforsare pentru tub din cupru

Cod	Dimensiune	Pret €	Ambalare
110 0014	15 x 1,0		50/1300
110 0013	18 x 1,0		100/800
110 0006	22 x 1,0		50/500



1147
1147CZ
Stut reductie

Cod	Dimensiune	Pret €	Ambalare
113 0062	15 x 10		25/900
113 0026	15 x 12		25/900
113 0079	18 x 12		25/750
110 0243	18 x 14		25/750
113 0018	18 x 15		25/750
110 0025	18 x 16		25/750
113 0083	22 x 12		25/500
113 0028	22 x 15		25/500
113 0022	22 x 18		25/500
113 0152	28 x 15		25/300
113 0067	28 x 22		10/300



1014
1114
Piulita pentru racord de compresiune pentru tub din cupru

Cod	Dimensiune	Pret €	Ambalare
100 0034	15		50/700
110 0055	18		50/600
100 0035	22		25/400
100 0055	28		25/250



1015
1115
Inel pentru racord de compresiune pentru teava de cupru

Cod	Dimensiune	Pret €	Ambalare
100 0026	15		50/2000
110 0077	18		50/2000
100 0039	22		50/1200
100 0097	28		50/800



**1039S**

Teu cu tub portsonda (sonda \varnothing 6 mm), piulita si inel pentru teava de cupru

Cod	Dimensiune	Lung. sonda	Pret €	Ambalare
471 0064	15 x 15	123 mm		2/10
471 0034	18 x 18	123 mm		2/10
471 0073	18 x 18	164 mm		2/10
471 0024	22 x 22	123 mm		2/10

**1040S**

Teu cu stut portsonda (sonda \varnothing 6 mm), M/M

Cod	Dimensiune	Lung. sonda	Pret €	Ambalare
471 0095	1" x 1"	123 mm		2/10
471 0080	1" x 1"	164 mm		2/10

**1039J**

Teu cu piulita si inel pentru teava de cupru si supapa manuala de aerisire

Cod	Dimensiune	Pret €	Ambalare
471 0063	15 x 15		10/100
471 0047	18 x 18		5/50
471 0013	22 x 22		5/50

**1113KB**

Racord în cruce cu piulită si inel de compresie Pentru tub din cupru, racord cu prindere rapida COBRASUN cu stut port-sondă (sondă \varnothing 6 mm) si supapa de aerisire manual

Cod	Dimensiune	Lung. sonda	Pret €	Ambalare
471 0097	22 x DN16	123 mm		2/10

**1040T**

Teu cu capac M/M

Cod	Dimensiune	Pret €	Ambalare
471 0081	1" x 1"		5/50

**1119FD**

Racord cruce cu filet masculin, fata dreapta pentru tubul ondulat din otel si garnitura plata

 GARNITURA PLATA

Cod	Dimensiune	Pret €	Ambalare
471 0045	3/4" x 3/4"		5/50

**1117FD**

Racord cruce cu piulita si inel pentru teava de cupru, filet masculin, fata dreapta pentru tubul ondulat din otel si garnitura plata

 GARNITURA PLATA

Cod	Dimensiune	Pret €	Ambalare
471 0033	18 x 3/4"		5/50
471 0014	22 x 3/4"		5/50

**1118**

Cruce cu piulita si inel pentru tub din cupru

Cod	Dimensiune	Pret €	Ambalare
471 0053	18 x 18		5/50
471 0029	22 x 22		5/50

**9561T**

Tub pentru sonda (∅ 6 mm) racord 1/2" cu piulita pentru cupru

Cod	Dimensiune	Pret €	Ambalare
472 0002	123 mm		5/15
472 0005	164 mm		5/15

**3353G**

Supapa manuala de aerisire cu garnitura de cupru

Cod	Dimensiune	Pret €	Ambalare
472 0003	1/2"		10/500

**1900KITSUN**

Supapa automata de aerisire cu robinet cu sfera. Temperatura maxima 180°C

Cod	Dimensiune	Pret €	Ambalare
472 0004	1/2"		2/20

**1117FD-1118
1119FD**

OPTIUNI DE ASAMBLARE

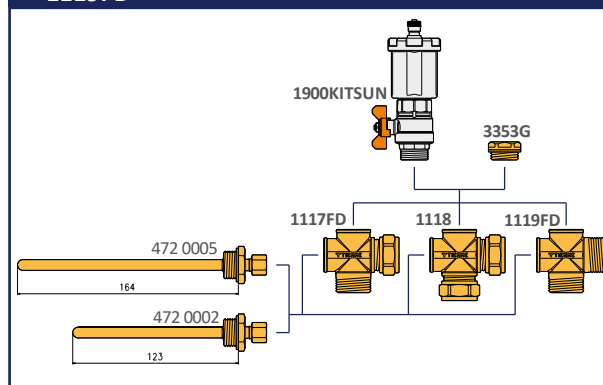

**0700X**

Pereche de tuburi ondulate din oțel inoxid preizolate cu cablu electric pentru conectarea sondei de temperatură la controlerul electronic

Cod	Dimensiune	Pret €/m	Ambalare (m)
070 0008	DN16		10/10
070 0002	DN16		15/15
070 0001	DN16		20/20
070 0004	DN16		25/125
070 0005	DN20		15/15
070 0003	DN20		20/20
070 0007	DN20		25/125
070 0006	DN25		20/20

**0720X**

Tub oțel inoxid ondulat

Cod	Dimensiune	Pret €/m	Ambalare (m)
070 0017	DN12 (sp. 0,15)		100/1000
070 0013	DN16 (sp. 0,18)		100/1000
070 0014	DN20 (sp. 0,18)		100/1000
070 0015	DN25 (sp. 0,22)		50/500
070 0018	DN32 (sp. 0,22)		25/375

**0721X**

Tub ondulat din oțel inoxid în izolație termică

Cod	Dimensiune	Pret €/m	Ambalare (m)
070 0016	DN16		50/250

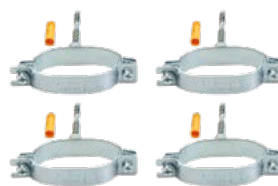
**0705COL**

Set 4 coliere ovale pentru fixarea pe perete a perechii de tuburi ondulate din oțel inoxid

Cod	Dimensiune	Pret €	Ambalare
071 0006	DN16		1/20
071 0010	DN20		1/20
071 0015	DN25		1/20



CERTIFICAT DE CALITATE

TIEMME RACCORDERIE S.p.A.

Producator al sistemelor de incalzire in pardoseala,
instalatii sanitare si de gaz, cu sediul in Castegnato (BS)

Via Cavallera 6/A,

in conformitate cu Legea 46/1990 "Norme pentru siguranta instalatiilor"
si cu D.P.R. 447 din 6 decembrie 1991

"Norme de aplicare a Legii 46/1990, privind siguranta instalatiilor"

CERTIFICA

faptul ca toate produsele livrate clientilor sunt proiectate si produse
in conformitate cu normele tehnice si standardele
internationale de calitate
cuprinse in EN ISO 9000.

Calitatea produselor TIEMME a fost recunoscuta de catre prin ISO 9001,
care atesta seriozitatea companiei in perfectionarea,
producerea si comercializarea articolelor din catalog.

Reprezentant Legal

COPIE FACSIMIL

Documentul in original si textul integral al normelor enuntate sunt disponibile la sediul
TIEMME RACCORDERIE S.p.A., Via Cavallera 6/A (loc. Barco) - 25045 - Castegnato (BS)



MINISTERUL DEZVOLTĂRII, LUCRĂRILOR PUBLICE ȘI ADMINISTRAȚIEI
CONSILIUL TEHNIC PERMANENT PENTRU CONSTRUCȚII



Agrement Tehnic
017-05/3951-2023

TEVI PE-X, ȘI FITINGURI CU ÎMBINARE PRIN PRESARE PENTRU INSTALAȚII
TUYAUX PE-X, ET RACCORDS AVEC SERRAGE POUR INSTALLATIONS
PE-X, PIPES AND CRIMP FITTINGS FOR NETWORKS
PE-X, ROHRE UND MESSINGSFITTINGS FÜR NETZE
Cod categorie 28 și 29

PRODUCĂTOR: TIEMME RACCORDERIE S.P.A.
Via Cavallera 6/A, 25043 Castagnato (BS)
ITALIA
tel: 0039030-2142211; fax: 0039030-2142206

TITULAR AGREMENT TEHNIC: S.C. TIEMME SYSTEMS S.R.L.
Str. Rădăniului, nr. 7, Bălinița Deal, Județ Giurgiu
tel: 004021-3115160; fax: 004021-3119150

ELABORATOR AGREMENT TEHNIC: INSTITUTUL EUROPEAN PENTRU ȘTIINȚE TERMICE
str. Matei Velevod, nr. 29, sector 2, București
ROMÂNIA
tel/fax: 004021-2521157

Grupa specializată nr. 5 - „Producse, procedee și echipamente pentru instalații aferente construcțiilor”

Prezentul agrement tehnic este valabil până la data de 28 octombrie 2026 numai însoțit de AVIZUL TEHNIC al Consiliului Tehnic Permanent pentru Construcții și nu pune loc de certificat de calitate.



MINISTERUL DEZVOLTĂRII, LUCRĂRILOR PUBLICE ȘI ADMINISTRAȚIEI
CONSILIUL TEHNIC PERMANENT PENTRU CONSTRUCȚII



Agrement Tehnic
017-05/3952-2023

FITINGURI METALICE PENTRU INSTALAȚII
METAL FITTINGS FOR INSTALLATIONS
RACCORDS METALLIQUES POUR INSTALLATIONS
METALS FITTINGS FOR NETZE
Cod categorie 28 și 29

PRODUCĂTOR: TIEMME RACCORDERIE S.P.A.
25043 Castagnato (BS), Via Cavallera 6/A
ITALIA
tel: 0039030-2142211; fax: 0039030-2142206

TITULAR AGREMENT TEHNIC: S.C. TIEMME SYSTEMS S.R.L.
Str. Rădăniului, nr. 7, Bălinița Deal, Județ Giurgiu
tel: 004021-3115160; fax: 004021-3119150

ELABORATOR AGREMENT TEHNIC: INSTITUTUL EUROPEAN PENTRU ȘTIINȚE TERMICE
str. Matei Velevod, nr. 29, sector 2, București
ROMÂNIA
tel/fax: 004021-2521157

Grupa specializată nr. 5 - „Producse, procedee și echipamente pentru instalații aferente construcțiilor”

Prezentul agrement tehnic este valabil până la data de 28 iulie 2026 numai însoțit de AVIZUL TEHNIC al Consiliului Tehnic Permanent pentru Construcții și nu pune loc de certificat de calitate.



MINISTERUL DEZVOLTĂRII, LUCRĂRILOR PUBLICE ȘI ADMINISTRAȚIEI
CONSILIUL TEHNIC PERMANENT PENTRU CONSTRUCȚII



Agrement Tehnic
017-05/3953-2023

ARMATURI DIN ALAMĂ PENTRU INSTALAȚII DE ÎNCĂLZIRE ȘI RĂCIRE
BRASS VALVES FOR HEATING AND COOLING INSTALLATIONS
TARMATURES EN LAITON POUR INSTALLATIONS
DE CHAUFFAGE ET REFRIGEREMENT
MESSING ARMATUREN FÜR HEIZUNG UND NETZE
Cod categorie 28 și 29

PRODUCĂTOR: TIEMME RACCORDERIE S.P.A.
25043 Castagnato (BS), Via Cavallera 6/A
ITALIA
tel: 0039030-2142211; fax: 0039030-2142206

TITULAR AGREMENT TEHNIC: S.C. TIEMME SYSTEMS S.R.L.
Str. Rădăniului, nr. 7, Bălinița Deal, Județ Giurgiu
tel: 004021-3115160; fax: 004021-3119150

ELABORATOR AGREMENT TEHNIC: INSTITUTUL EUROPEAN PENTRU ȘTIINȚE TERMICE
str. Matei Velevod, nr. 29, sector 2, București
ROMÂNIA
tel/fax: 004021-2521157

Grupa specializată nr. 5 - „Producse, procedee și echipamente pentru instalații aferente construcțiilor”

Prezentul agrement tehnic este valabil până la data de 28 noiembrie 2026 numai însoțit de AVIZUL TEHNIC al Consiliului Tehnic Permanent pentru Construcții și nu pune loc de certificat de calitate.



MINISTERUL DEZVOLTĂRII, LUCRĂRILOR PUBLICE ȘI ADMINISTRAȚIEI
CONSILIUL TEHNIC PERMANENT PENTRU CONSTRUCȚII



Agrement Tehnic
017-05/3999-2023

TEVI MULTISTRAT ȘI FITINGURI CU ÎMBINARE PRIN PRESARE PENTRU INSTALAȚII DE APĂ ȘI AER
TUYAUX MULTICOUCHEES ET RACCORDS AVEC SERRAGE POUR INSTALLATIONS D'EAU ET AIR
MULTILAYER PIPES AND CRIMP FITTINGS FOR WATER AND AIR NETWORKS
MEHRLAGIG ROHRE UND MESSINGSFITTINGS FÜR WASSER UND LUFT NETZE
Cod categorie 28 și 29

PRODUCĂTOR: TIEMME RACCORDERIE S.P.A.
Via Cavallera 6/A, 25043 Castagnato (BS)
ITALIA
tel: 0039030-2142211; fax: 0039030-2142206

TITULAR AGREMENT TEHNIC: S.C. TIEMME SYSTEMS S.R.L.
Str. Rădăniului, nr. 7, Bălinița Deal, Județ Giurgiu
tel: 004021-3115160; fax: 004021-3119150

ELABORATOR AGREMENT TEHNIC: INSTITUTUL EUROPEAN PENTRU ȘTIINȚE TERMICE
str. Matei Velevod, nr. 29, sector 2, București
ROMÂNIA
tel/fax: 004021-2521157

Grupa specializată nr. 5 - „Producse, procedee și echipamente pentru instalații aferente construcțiilor”

Prezentul agrement tehnic este valabil până la data de 28 octombrie 2026 numai însoțit de AVIZUL TEHNIC al Consiliului Tehnic Permanent pentru Construcții și nu pune loc de certificat de calitate.



Produsele fabricate de TIEMME Raccorderie S.p.A. (denumita in continuare: Companie) sunt garantate pentru doi ani de la data vanzarii. Aceasta garantie se alatura si nu prejudiciaza drepturile cumparatorului prevazute in Directiva Europeana 99/44/CE si in legislatia nationala de punere in aplicare, cu exceptia cazurilor în care se menționează altfel.

Nu beneficiaza de garantie produsele defecte sau eventualele pagube cauzate de:

- transportul ce nu a fost efectuat in mod direct de catre Companie;
- nerespectarea instructiunilor si avertizarilor prevazute de catre producator in manuale, instructiuni si/sau cataloage de produse;
- nerespectarea normelor si/sau dispozitiilor prevazute in legislatia si/sau regulamentele in vigoare;
- absenta sau neconformitatea lucrarilor de intretinerea periodica, dezinteresul in folosire, incapacitatea de utilizare, interventiile neautorizate;
- instalarea necorespunzatoare si/sau disfunctionalitati de orice fel in alimentarea instalatiilor sanitare, electrice, de alimentare cu combustibil si/sau de evacuare;
- tratarea in mod neadecvat a apei ce alimenteaza instalatia, tratamente de detartrare efectuate in mod eronat;
- corozivitatea cauzata de agresivitatea apei sau a condensului;
- inghet, curenti paraziti si/sau efecte nocive ale descarcarilor electrice atmosferice;
- inlocuiri preventive;
- situatii de forta majora independente de vointa sau controlul Companiei producatoare.

Eventualele defecte ale materialelor, existenta viciilor ascunse, precum si erorile, diferentele de dimensiune ce depasesc tolerantele de fabricatie, vor angaja Compania sa inlocuiasca piesele defecte.

Eventualele returnuri de produse neconforme vor fi acceptate numai dupa autorizarea prelabila in scris (autorizare de retur) din partea Companiei. In orice caz produsele vor fi returnate la sediul Companiei in conditii porto franco, pe cheltuiala clientului. In caz contrar marfa va fi refuzata si returnata expeditorului.

Orice eventual retur de produse conforme va fi autorizat in prelabil de Companie. In acest caz costurile de transport vor fi suportate de catre client. Acoperirea prin polita de asigurare are o durata de 10 ani de la data livrării din fabricile Companiei.

Numai in cazul in care montarea de produse neconforme ale Companiei cauzeaza pagube materiale sau accidente umane, Tiemme va contacta Compania de Asigurari pentru remedierea acestor situatii conform normelor din polita de asigurare. Pentru a demara procedura de despagubire cu Compania de Asigurari, Tiemme trebuie sa primeasca de la clientul respectiv o informare despre incident, in scris, in termen de 10 zile de la aparitia evenimentului. De asemenea trebuie transmise toate informatiile solicitate in chestionarul dosarului de asigurare, informatii referitoare la detaliile producerii evenimentului, atasand toate documentele si probele necesare pentru a se putea gestiona procedura de despagubire, totul in termen de 30 zile.

Nu va fi recunoscuta nicio despagubire clientului inainte ca Tiemme sa verifice cauza reclamatiei si/sau a daunelor.

In cazul in care sunt necesare sau solicitate teste de laborator pentru a verifica, cerceta, defini neconformitatea unui retur/reclamatie/daune, si responsabilitatea nu poate fi atribuita Companiei Tiemme, cheltuielile vor fi suportate de catre solicitant. Instalatorii trebuie sa efectueze si sa documenteze verificarile instalatiilor in conformitate cu reglementarile internationale in vigoare.

S.C. TIEMME SYSTEMS S.R.L.

lesire Autostrada Bucuresti-Pitesti, Km 23, Com. Bolintin Deal, Str. Rasaritului, Nr. 7, Cod Postal 087015, Jud. Giurgiu
Cod Fiscal RO 16557181, Nr. Ord. Reg. Com. J52/16/2015

Vanzarea marfii se face in urma incheierii unui contract de vanzare-cumparare incheiat intre S.C. TIEMME SYSTEMS S.R.L. in calitate de Vanzator si fiecare client in parte, in calitate de Cumparator.

La livrare, marfa va fi insotita de urmatoarele documente:

- instructiuni privind instalarea, punerea in functiune, exploatarea si intretinerea (acolo unde este cazul);
- declaratie de conformitate;
- certificat de garantie pentru produs;
- factura fiscala;
- aviz de insotire a marfii.

Documentele sus-mentionate vor fi redactate in limba romana.

Producele vandute se vor factura la cursul de schimb euro/leu al BNR din ziua emiterii facturii.

Conditiiile de vanzare sunt cele stabilite prin contract.

Daca cumparatorul nu respecta conditiile de vanzare si plata, S.C. TIEMME SYSTEMS S.R.L. isi rezerva dreptul de a suspenda viitoarele livrari.

COMENZI

Comenzile de marfa duc la rezervarea marfii doar in momentul confirmarii de catre client a facturii proforme si nu implica obligativitatea din partea Vanzatorului de a face livrari partiale.

PRETURI

La preturile de lista se pot stabili de comun acord o serie de reduceri pentru fiecare categorie de produse in parte, preturi ce vor fi valabile pana la momentul in care intervin modificari acceptate de ambele parti. Daca nu exista acorduri diverse confirmate in scris de ambele parti, livrarile se vor face la preturile valabile la data livrarii. Preturile de vanzare sunt pentru conditia de livrare FRANCO DEPOZIT VANZATOR.

LIVRARI

Marfa se livreaza in mod normal prin curierat rapid, daca nu exista acorduri diverse intre parti. Marfa va fi transportata sub raspunderea transportatorului chiar si in situatia in care conditia de livrare este FRANCO DESTINATAR.

PLATI

Conditiiile de plata sunt cele inscrise in factura si sunt obligatorii. Orice intarziere in ce priveste termenul de plata se va penaliza fara preaviz cu procentul stipulat in contractul de vanzare cumparare pe fiecare zi de intarziere din suma restanta, pana la data achitarii integrale. Comisioanele bancare de plata intra in totalitate in sarcina clientului.

RECLAMATII

Nu se accepta reclamatii la mai mult de 5 zile lucratoare de la data primirii marfii. Orice reclamatie catre TIEMME se va face in scris si va fi transmisa la sediul nostru.

RETURURI

Nu se accepta returul de marfa fara acordul in prealabil al TIEMME SYSTEMS. Atat cererea de acceptare a returului de marfa cat si acceptul returului se vor face in scris. Marfa returnata se va expedia pe adresa depozitului TIEMME SYSTEMS pe cheltuiala clientului.

SUSPENDAREA COMENZILOR SI FORTA MAJORA

In cazul in care cumparatorul nu a respectat conditiile comerciale concordate, chiar si partial, societatea noastra poate suspenda livrarile ulterioare. Societatea noastra este exonerata de raspunderea contractuala in caz de aparitie a unei situatii de forta majora.

MODIFICARI

TIEMME isi rezerva dreptul de a face, fara notificare, in orice moment si din orice motiv, orice modificari necesare de natura tehnica.

LITIGII

Orice litigii vor fi supuse spre solutionare instantelor judecatoresti competente.

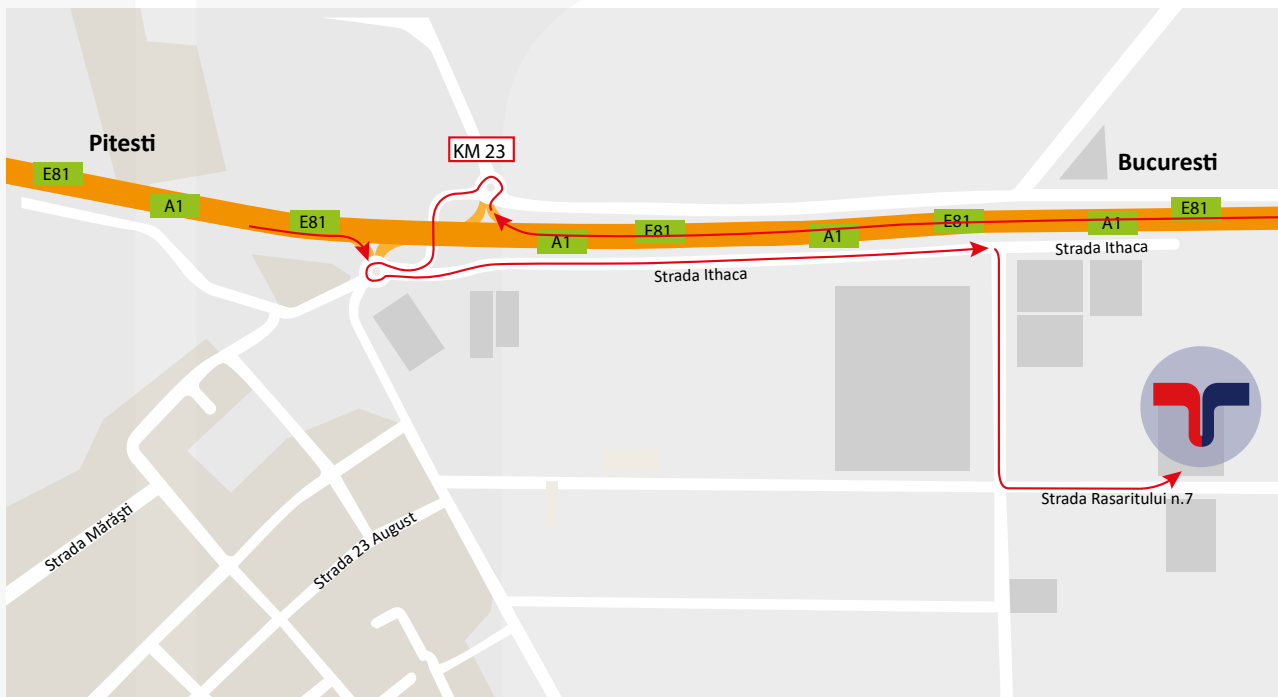

TIEMME SYSTEMS S.R.L.

ieșire Autostrada Bucuresti-Pitesti KM 23
Str. Rasaritului nr. 7 Bolintin-Deal
087015, Jud. Giurgiu

GPS 44°.27'.45" N
25°.50'.43" E

Tel. +40 021-311.51.60 - Fax +40 021-311.91.50

tiemmesystems@tiemme.com
www.tiemme.com

COMPONENTE SI SISTEME INTEGRATE PENTRU INSTALATII HIDRO-TERMO-SANITARE



COMPONENTE HIDRAULICE



CAMERA TEHNICA - CONTORIZARE



SISTEME RADIANTE



BATERII

