



CATALOG - LISTA DE PREȚURI

1146 / RO

Scanați codul QR pentru a consulta lista de prețuri



1	ROBINETI CU SFERA DIN ALAMA APĂ ȘI GAZ	
2	RACORDURI DE COMPRESIE PENTRU TUB MULTISTRAT "AL-COBRAPEX" - SERIA 1600	
3	RACORDURI DE PRESARE PENTRU TUB MULTISTRAT "AL-COBRAPEX" - SERIA 1650	
4	RACORDURI DE COMPRESIE PENTRU TUB "COBRAPEX" - SERIA 1400	
5	RACORDURI DE PRESARE PENTRU TUB "COBRAPEX" - SERIA 1700	
6	RACORDURI DE COMPRESIE PENTRU TUB DIN CUPRU CU INEL DIN ALAMĂ - SERIA 1000/1100	
7	RACORDURI UNIVERSALE PENTRU CUPRU, PEX SI TUB MULTISTRAT - SERIA WATERBLOCK	
8	TUB MULTISTRAT "AL-COBRAPEX" SI POLIETILENA "COBRAPEX" SI "COBRAPERT"	
9	RACORDURI DE COMPRESIE CU O-RING DIN ALAMĂ PENTRU TUBURI DIN PE/PEHD/PEX - SERIA 3460	
10	RACORDURI GENERALE DIN ALAMA - SERIA 1500	
11	COLECTOARE DE DISTRIBUTIE	
12	ROBINETI PENTRU RADIATOARE	
13	SISTEME DE INCALZIRE PRIN PARDOSEALA	
14	TERMOREGLARE	
15	COMPONENTE PENTRU CENTRALE TERMICE/INCALZIRE	
16	SISTEM SOLAR TERMIC CU CIRCULATIE FORTATA PENTRU PRODUCEREA APEI CALDE MENAJERE	
17	CONTORIZARE DIRECTA MODULE TERMICE	

“Oamenii noștri, competențele și experiența lor
au fost întotdeauna principalul atu al companiei noastre.
Aceasta este valoarea cheie care ne permite să înțelegem nevoile
clienților noștri italieni, precum și ale clienților noștri
din întreaga lume, furnizându-le servicii și produse
care sunt întotdeauna specifice și inovatoare”.

Președintele

Giuliano Gnutti

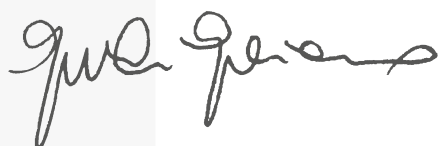



Gruppo Gnutti este una dintre principalele realitati ale antreprenoriatului din Brescia inca din anii '50, cu o activitate bine inradacinata in teritoriu. Un grup de firme care detine intregul lant tehnico-productiv si transforma materia prima intr-un produs finit. Un acord perfect intre Traditie, Profesionalism, Calitate, Tehnologie si Know-How pentru a putea oferi cel mai bun serviciu in fiecare zi. Gruppo Gnutti s-a nascut din dezvoltarea si cresterea Gnutti Cirillo S.p.A.



Tiemme Raccorderie a fost înființată în anii '80 ca o companie care produce și distribuie fittinguri, supape din alama și tevi. În 1994 s-a alăturat „Gruppo Gnutti”, anul în care compania a cunoscut o schimbare radicală. Anii 2000 reprezintă o fază de creștere și evoluție ulterioară a companiei prin dezvoltarea sistemelor integrate în domeniul încălzirii. În 2012, la sediul din Castegnato a luat naștere “Tiemme Lab”, laboratorul termotehnic inovator al Tiemme. Filialele din Spania, Grecia și România doresc să răspundă unei piețe din ce în ce mai extinse și mai exigente, îndreptând privirea companiei către o perspectivă de internaționalizare.



Societatea „**Valvosanitaria Bugatti**” este creată în anul 1948 în localitatea Lumezzane (BS) bazându-și propria activitate în producerea robinetelor. În timp activitatea societății se specializează în producerea robinetelor cu sfera, iar în anul 1984 societatea își schimbă sediul în localitatea Castegnato. Societatea este dotată cu un depozit ce pune la dispoziție o gamă amplă de produse asigurând organizarea eficientă a livrărilor și completarea stocurilor. În anul 2023 societatea „Valvosanitaria Bugatti” intră în componența „Gruppo Gnutti”. La ora actuală este o societate ce își are locul său pe piața internațională în producerea robinetelor cu sfera pentru apă și gaz, a racordurilor, a bateriilor sanitare și a componentelor pentru instalațiile de încălzire.



Gnutti Cirillo S.p.A. fondată în 1951 de Cirillo Gnutti ca firmă mecanică pentru construcția de scule și matrite, și astăzi este lider mondial în domeniul stantării la cald și a prelucrării mecanice a alamei și a altor metale neferoase. Gnutti Cirillo S.p.A. a atins un nivel înalt de competență tehnică ce îi permite să satisfacă orice solicitare datorită autosuficienței în lanțul de producție. Începând de la proiectare, trecând prin construcția sculelor și uneltelor, stantarea la cald a alamei, prelucrări, tratamente de suprafață, montaje automate până la ambalarea produsului finit; toate realizate în cadrul grupului cu posibilitatea de personalizare în conformitate cu specificațiile clientului. Uzina Odolo (BS) a fost adăugată sediului istoric din Lumezzane (BS) în 2000.



De-a lungul anilor, procesul de internaționalizare a grupului a continuat odată cu înființarea **Metal Forming Technology Inc.** Situată în statul Michigan (SUA), MFT a atins standarde înalte de eficiență în producția de articole din alama stantată la cald și prelucrate conform specificațiilor clientului. Compania acționează, de asemenea, ca și centru logistic și de asistență pentru clienții Gnutti Cirillo S.p.A. din piața nord-americană și canadiană.



EMC Component este o companie fondată în 2011, specializată în proiectarea, producerea și comercializarea de accesorii pentru transformatoare electrice de distribuție și putere. Toate produsele „EMC” au la bază o idee și o necesitate specifică a pieței de desfacere. În interiorul „EMC” aceste produse sunt proiectate, devin prototipuri, sunt testate și în cele din urmă realizate; prin urmare sunt fabricate 100% “Made in Italy”, ce constituie o garanție de maximă calitate și fiabilitate.



 **TIEMME**
ORIGINAL ITALIAN TRADEMARK 



nr. 13738-A



Tiemme Raccorderie® S.p.A. este astazi o societate lider in sectorul producerii si comercializarii de articole hidro-termo-sanitare; capacitatea sa de dezvoltare se observa, cu precadere, dupa intrarea sa in Grupul Gnutti, din anul 1994.

Societatea isi are sediul in Castegnato, in provincia Brescia si isi desfasoara activitatea in doua cladiri: una cu o suprafata de 7.000 mp. acoperiti, in care se afla birourile si unde se desfasoara o parte din activitatea de productie si una de 15.000 mp.in care se afla depozitele si productia pentru tubul din polietilena reticulata PEX.

Sistemul de Calitate Tiemme Raccorderie S.p.A. este instrumentul ce garanteaza clientilor sai produse si servicii care sa satisfaca expectativele acestora, atat in ceea ce priveste calitatea produselor, cat si in ceea ce priveste punctualitatea in onorarea comenzilor; societatea este in plina si continua imbunatatire a calitatii serviciilor, avand in vedere si respectul pentru siguranta mediului ambiant.

In anul 1999, Tiemme Raccorderie S.p.A. a obtinut certificarea ISO 9002 pentru propriul sistem de calitate, iar in anul 2003 a obtinut certificarea ISO 9001, ca o consecinta naturala a politicii firmei pentru calitate totala si de atingere a excelentei in domeniu.

Produsele Tiemme Raccorderie S.p.A. sunt controlate si recunoscute in intreaga lume de peste 70 din cele mai prestigioase organizatii de omologare.

O intreaga echipa de tehnicieni cu o formare profesionala deosebita, sta permanent la dispozitia clientilor.

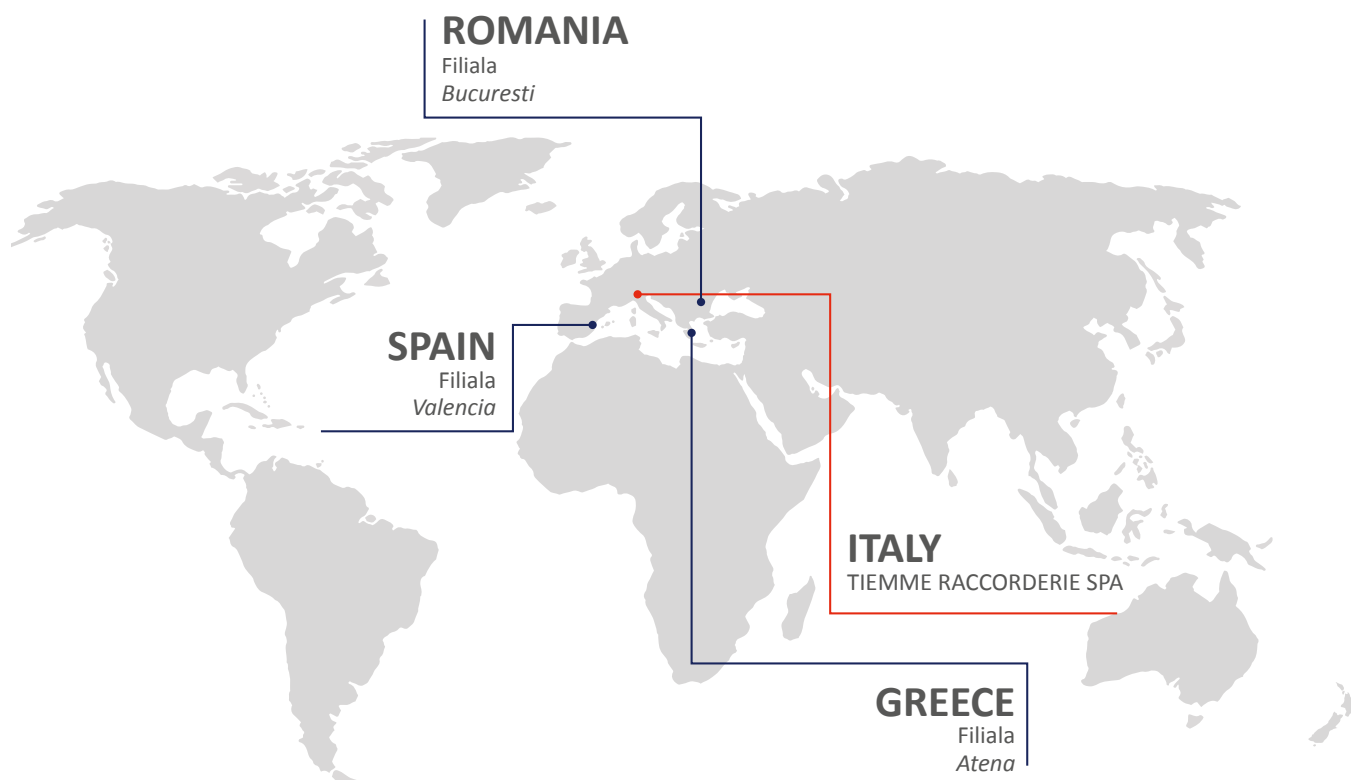



TIEMME
ORIGINAL ITALIAN TRADEMARK

CERTIFICARI

		ITALY TTR INSTITUTE		ARGB KVBG	BELGIUM UNIVERSITE LIBRE DE BRUXELLES
		ITALY RINA REGISTRO NAVALE ITALIANO			UKRAINE ORGANO DI CERTIFICAZIONE CCV "TECKO"
		ITALY ISTITUTO GIORDANO			SLOVAKIA TECHNICKÝ SKÚŠOBNÝ ÚSTAV PIEŠŤANY, Š.P.
		ITALY ICIM			CZECH REPUBLIC VYZKUMNY USTAV POZEMNICH STAVEB – CERTIFIKACNI SPOLECNOST S.R.O.
		ITALY ICIM CERTIFICATO SECONDO DM N. 174/2004			CZECH REPUBLIC STROJÍRENSKÝ ZKUŠEBNÍ ÚSTAV
		ITALY ISTITUTO NAZIONALE ASSICURAZIONE INFORTUNI SUL LAVORO			RUSSIA GOST CERTIFICATION
		GERMANY DEUTSCHER VEREIN DES GAS-UND WASSERFACHES			RUSSIA HYGIENE CERTIFICATE
		AUSTRIA ÜA HYGIENE CERTIFICATE			RUSSIA EAC CERTIFICATE
		DENMARK ETA - DANISH BOARD OF EUROPEAN TECHNICAL APPROVAL FOR CONSTRUCTION PRODUCTS			POLAND PANSTWOWY ZAKLAD HYGIENY NATIONAL INSTITUTE OF HYGIENE
		DENMARK GODKENDT TIL DRIKKEVAND			POLAND INSTYTUT TECHNIKI BUDOWLANES
		DENMARK DTI ENERGY DANSK TEKNOLOGISK INSTITUT			HUNGARY ÉPÍTÉSÜGYI MINŐSÉGELLENŐRZŐ INNOVÁCIÓS NONPROFIT KFT.
		NORWAY SINTEF CERTIFICATION			UNITED KINGDOM BRITISH GAS TECHNOLOGY
		SWEDEN RI.SE RESEARCH INSTITUTES OF SWEDEN			UNITED KINGDOM WATER REGULATION ADVISORY SCHEME
		FINLAND YMPÄRISTÖMINISTERIÖN TYYPPIHYVÄKSYNTAPÄÄTÖS THE FINNISH MINISTRY OF ENVIRONMENT			UNITED KINGDOM KUKREG4
		SPAIN AENOR			FRANCE LABORATOIRE SANTÉ ENVIRONNEMENT HYGIÈNE DE LYON
		HOLLAND CENTRUM VOOR GASTECHNOLOGIE			FRANCE CENTRE SCIENTIFIQUE ET TECHNIQUE DU BÂTIMENT
		HOLLAND CERTIFICATIE EN KEURINGEN			FRANCE CERTIFICATION NF
		PORTUGAL CERTIF ASSOCIAÇÃO PARA A CERTIFICAÇÃO			BELARUS STROYTECHNORM
		ROMANIA AGREMENT TEHNIC ÎN CONSTRUCTII ROMÂNIA			SERBIA UNIVERSITY OF NIŠ FACULTY OF MECHANICAL ENGINEERING
		BULGARIA TUV RHEINLAND BULGARIA LTD.			EUROPE MARCHIO CE DI PRODOTTO
		AUSTRALIA IAPMO WATERMARK LICENCE			VIETNAM TESTING CENTER 3
		AUSTRALIA IAPMO OCEANA MARK			SOUTH AFRICA AENOR
		AUSTRALIA AGA CERTIFIED PRODUCT			



2300 - 2301
2302 - 2304
2305 - 2306
2303 - 2307
 Robineti cu sfera "ODIN" cu trecere totala și presetupa reglabila

PAG. 7



2277B
 Robinet cu sfera pentru tub PE cu tija de manevra 28 mm (Cu stut de ranforsare)

PAG. 31



2272LAFSP4
 Robinet coltar cu sfera pentru tub PE anti-frauda cu 4 stuturi de drenaj

PAG. 31



2135
 Robinet cu sfera, motorizat cu 3 cai deviator, cu 3 intrari

PAG. 41



2135ISOL
 Izolatie pentru robinet de zona cu by-pass (art. 2136) si pentru robinet deviator (art. 2135)

PAG. 41



2218G
 Robinet de colt pentru gaz M/F ISO 7/EN 10226 cu maneta tip fluture de culoare galbena

PAG. 60



2219G
 Robinet de colt pentru gaz F/M ISO 7/EN 10226 cu maneta tip fluture de culoare galbena

PAG. 60



1108FD
 Teu M fata dreapta

PAG. 128



155217 - 153017
155517 - 156517
187817
 Racorduri generale din alama - Filetare conică ISO7 / EN 10226-1

PAG. 190



4500N
 NEW CLASSIC panoul izolant din polistiren expandat sinterizat respecta normele UNI EN 13163.

PAG. 271



4729
 Supapa de sens termostatica

PAG. 293



4626D
 Distributor electric cu 6 zone pentru conectarea termostatelor prin fir si a servomotoarelor electrice corespunzatoare

PAG. 313



3149HF
 TM-MAG MAXI Filtru magnetic linear cu separator de impuritati, cu iesiri F - cu debit ridicat

PAG. 345



HEAT-EVO5

Modul termic HEAT-EVO5 cu 1 schimbator de caldura

PAG. **395**



HEAT-DUAL1

Modul termic HEAT-DUAL1 cu 2 schimbatoare de caldura

PAG. **398**



HEAT-EVO1 HEAT-EVO2 HEAT-EVO3 HEAT-EVO4 HEAT-EVO1DYN

Modul termic HEAT-EVO cu 1 schimbator de caldura

PAG. **400**

INDICE

ART	PAG	ART	PAG	ART	PAG	ART	PAG	ART	PAG	ART	PAG
0191X	70	1000	122	1115	132	1420K	103	1495	149	1550CT	172
0200B	157	1001	122	1115	388	1420K	138	1495	159	1551	175
0200B	276	1001	385	1116	130	1420K (PEX)	104	1495	278	1551C	176
0200R	157	1002	122	1116	388	1420P	104	1495R63	159	1551FD	176
0200R	276	1003	123	1117FD	390	1420P	111	1496	149	1551FD	385
0210R	158	1003	386	1118	390	1420P	138	1496	159	1552	173
0210R	276	1004	122	1119FD	390	1420Z	104	1496R42	159	1552C	173
0230B	157	1005	123	1120	130	1420Z	111	1497	150	1552FD	338
0230R	157	1005	386	1133	127	1420Z	138	1497EST	150	1552FD	385
0300B	154	1007	124	1133	386	1428MP	102	1498MT	150	1552FD	173
0300BB	154	1007	387	1135	129	1428XL	102	1498SET	150	1552FDR	385
0300BL	155	1009	123	1135	388	1431	130	1498UM	150	1552FDR	173
0300N	155	1010	124	1138	128	1433K	231	1498US	150	1552I7	189
0300R	155	1014	132	1138	387	1435	225	1500	186	1552SET	384
0330B	154	1014	388	1139	128	1435K	225	1501	186	1552XL	173
0330R	154	1015	132	1139	387	1435N	140	1502	187	1553FD	386
331G	237	1015	388	1140	126	1435N	225	1503	187	1553FD	185
331H	237	1035	124	1141	127	1436	228	1504	187	1555	181
331HKIT	248	1035	388	1142	129	1436	295	1505C04	104	1555CP	182
331HKIT01	248	1037	124	1143	129	1436K	229	1505C04	111	1555I7	189
332G	237	1039	123	1144	129	1436N	141	1505C04	139	1555R	182
332H	237	1039	387	1145	129	1436N	228	1507	185	1555SET	184
332HKIT	248	1039J	389	1147	131	1436N	295	1508	185	1555SET	309
332HKIT01	248	1039S	389	1147	388	1436N06	206	1510	186	1555U	182
475KIT	377	1040S	389	1147CZ	131	1436N06	296	1511	186	1557	183
475KITISOL	377	1040T	389	1147CZ	388	1450	100	1513	183	1557CP	183
0600B	146	1100	125	1220	176	1460	168	1513	213	1557SET	343
0625	148	1100FD	125	1233	224	1461	168	1514	183	1557SET	184
0630B	146	1100FD	385	1233N	224	1462	168	1514	213	1557SET	309
0630R	146	1101	126	1235	224	1463	168	1516	186	1560	178
0635	147	1101	385	1235N	224	1464	168	1517	186	1560C	179
0636	147	1102	125	1240C	244	1465	168	1518	187	1560CT	172
0640B	147	1102FD	125	1240K	224	1467	169	1519	187	1561	179
0640R	147	1102FD	385	1240N	140	1468	168	1520	187	1561	189
0641	147	1103	127	1240N	224	1469	168	1521	183	1561C	179
0660	146	1103	386	1241K	228	1475	169	1521CP	183	1561CT	172
0660B	146	1104	126	1241N	142	1476	67	1521CPKIT	350	1561DIN	180
0660S	146	1104FD	126	1241N	228	1476	169	1521CPKIT	351	1562	178
0700X	391	1104FD	386	1243K	231	1480P	159	1522	184	1563	180
0705COL	391	1105	127	1400	100	1480P	276	1524	184	1564FD	184
0720X	391	1105	386	1401	100	1481	67	1524	345	1564FD	387
0721X	391	1106	127	1402	100	1481	92	1525N	184	1565	182
0800B	156	1107	128	1403	101	1481	105	1525N	345	1565CP	182
0800R	156	1107	387	1404	100	1481	117	1530	176	1565I7	189
0805B	158	1108	128	1405	101	1481	139	1530C	177	1565R	182
0805R	158	1108FD	128	1406	101	1490	103	1530I7	189	1567	179
0810B	156	1108FD	387	1407	101	1490KIT01	103	1531C	175	1570	181
0810R	156	1109	128	1408	101	1490P43	103	1540	174	1570	302
0900B	148	1110	128	1409	101	1491	103	1540C	174	1570	350
0900B	158	1113KB	389	1415	105	1492MP	103	1541	174	1570C	181
0900R	148	1114	132	1416	67	1493SET	96	1550	175	1570CT	172
0900R	158	1114	388	1416	105	1493Z	92	1550C	175	1571	181

■ Noutati

INDICE

ART	PAG	ART	PAG	ART	PAG	ART	PAG	ART	PAG	ART	PAG
1572	180	1636N	295	1663DI	85	1688	90	1716	231	1877K36	195
1572FD	180	1636N06	142	1663FL	84	1689	150	1716K	231	1877K50	196
1572FD	387	1638GN	138	1664	84	1690	25	1718	109	1877K50	196
1580	181	1640GN	136	1664CG	87	1690	94	1719CG	114	1877SKIT	218
1581	177	1641GN	136	1664CG55	87	1690U	25	1719CGXL	114	1878	185
1581C	178	1642GN	136	1664CG55XL	87	1690U	94	1720X	117	1878	212
1581FD	178	1643GN	136	1664CGXL	87	1691	24	1721U	112	1878	388
1581FD	386	1644GN	137	1664DI	85	1691	93	1722CY	111	187817	189
1582	178	1645GN	137	1664FLDX	84	1692	25	1730	111	1879	96
1583	184	1646GN	137	1664FLSX	84	1692	93	1735	115	1879	140
1584C	180	1647GN	137	1665	78	1692CK	25	1736	115	1879	142
1585C	180	1649GN	138	1665	227	1692CK	93	1740	116	1879	226
1590	190	1649YGN	137	1665	338	1693	96	1740U	116	1879	230
1591	190	1650	76	1665	343	1693PR	96	1746	116	1879K	232
1592	190	1650CT	74	1666	78	1694	77	1807	218	1880	185
1600	62	1651	76	1666	141	1695TM01	151	1810	216	1880	212
1600OR	62	1651CT	74	1666	230	1695TM01B	151	1812	216	1880C	185
1601	63	1651CY	79	1666K	232	1695TM01C	151	1812VIT	218	1881	212
1601KB	63	1651FS	78	1666K24	78	1695TM02	151	1822	192	1881	338
1602	62	1651KB	79	1667	77	1695TM02B	151	1822RCP	192	1882	213
1602	338	1652	76	1668	77	1695TM02C	151	1822RCP50	193	1883	204
1603	65	1652	338	1668	140	1695TM03	151	1828Z	338	1884	204
1604	63	1652CG	88	1668	226	1695TM03B	151	1829Z	262	1885	204
1605	64	1652CT	74	1669	80	1695TM03C	151	1832	192	1885ISOL	204
1606	64	1653	80	1670B	117	1696	25	1832RCP	192	1886	211
1607	66	1653CT	75	1670X	92	1696	94	1835C	49	1887	211
1608	65	1653KB	80	1671	77	1697	24	1836P	50	1889R	212
1609	66	1654	79	1672	90	1697	93	1837R	50	1889TERMO	296
1610	67	1654CT	74	1672CY	90	1697CK	24	1859	91	1890	212
1611	67	1654U	86	1673	90	1697CK	93	1859	141	1890ISOL	296
1612C	64	1655	79	1674	79	1699	149	1859	230	1890R	212
1613C	65	1655CT	75	1675	85	1700	108	1859	232	1892	213
1614BP	62	1656	83	1675ISOL	85	1701	109	1859	296	1895	204
1615BP	64	1656CE	83	1676	86	1701R	109	1859	338	1896	214
1616	64	1656DFCT	75	1676KB	86	1702	108	1859A16	140	1896	346
1616M	64	1656ISOL01	83	1676SM	86	1702CG	114	1859A16	226	1896GG	214
1619	65	1656ISOL02	84	1676USM	86	1703	110	1859A24	142	1896GG	346
1620	66	1656KB	84	1677	91	1704	109	1863	218	1898	214
1626	65	1656SM	83	1678	85	1704U	112	1863	292	1898	347
1631G	130	1656XL	83	1679KB	85	1705	110	1863	308	1898G34	214
1632K	197	1657	81	1680XL	84	1706	110	1864P	308	1898G34	347
1633K	231	1657CT	75	1681	118	1707	112	1865	218	1898KIT34	214
1635	225	1658	81	1681	152	1707R	112	1865	297	1898KIT34	347
1635C	244	1659	81	1681MINI	152	1709	112	1866CP	195	1899	215
1635K	226	1659CT	75	1681MINIRF	118	1710	110	1866K	194	1899	347
1635N	140	1660	80	1681MINIRF	160	1715	108	1868K	194	1900	215
1635N	225	1660	96	1681RF	118	1715	227	1868KOPPIA	194	1900	347
1636	229	1660BP	80	1681RF	160	1716	109	1870	218	1900G	215
1636	295	1661	80	1682	149	1716	140	1871K	197	1900G	347
1636K	229	1662	89	1683	149	1716	141	1872	213	1900G34	215
1636N	141	1662CG	89	1684	150	1716	226	1876K	198	1900G34	348
1636N	229	1662LG	89	1687	82	1716	230	1876K50	198	1900KITSUN	374

■ Noutati

INDICE

ART	PAG	ART	PAG	ART	PAG	ART	PAG	ART	PAG	ART	PAG
1900KITSUN	390	1940	217	2135 ■	220	2182RSAC	209	2266CK	27	2371G07	55
1900N34	215	1940	294	2135ISOL ■	41	2182RSAC	290	2266G	60	2371R07	11
1900N34	347	1940	301	2135ISOL ■	220	2183R	20	2266LAF	30	2371SUN	374
1900SUN	374	1941	217	2136	41	2183R	208	2266LP	35	2372	3
1901	215	1941	297	2136	220	2183R	290	2266OT	29	2380G07	55
1901	348	2070	211	2137	41	2184CPRKIT	21	2266OTW	29	2380R07	12
1901P	215	2070	287	2137	220	2184CPRKIT	210	2266QU	35	2381G07	55
1901P	348	2070	292	2138	40	2184CPRKIT	291	2266SP	28	2381R07	12
1901PN	215	2074MAX	328	2138	219	2186CPRKIT	21	2267AF	30	2450	9
1901PN	348	2074MIN	328	2139	40	2186CPRKIT	210	2267OT	30	2451	9
1910P	216	2075	319	2139	219	2186CPRKIT	291	2270	35	2460	9
1912	203	2075KIT01	308	2142	26	2200G	56	2271	35	2461	9
1912R	203	2075KIT02	308	2143	22	2201G	56	2271Q32	35	2471	9
1913	214	2075KIT03	342	2143	68	2210R	13	2272LAF	31	2472	9
1913	346	2076	319	2152	26	2211R	13	2272LAFSP4 ■	31	2510	36
1913G	214	2077	319	2153	22	2218G ■	60	2273AF	31	2511B	36
1913G	347	2078	319	2153	68	2219G ■	60	2277	30	2512B	36
1914	214	2079	328	2153FLR	22	2220G	56	2277B ■	31	2520	36
1914	346	2079-3V	328	2153FLR	68	2220R	13	2279AF	32	2530X316	36
1916	324	2079INV	328	2154FLR	22	2221G	56	2281	27	2535V	36
1916SUN	375	2080	325	2154FLR	68	2221R	14	2283AF	32	2584	36
1917	322	2080	363	2154R	22	2223G	60	2284SPCK	30	2585G	37
1917M	323	2080POST	325	2154R	68	2224G	60	2285	27	2588C	37
1917MAN	323	2080POST	363	2155FLR	23	2224N	28	2286KIT	298	2595	54
1917SUN	375	2081	325	2155FLR	69	2225G	60	2300 ■	7	2596	54
1918	322	2094	54	2155R	23	2228	28	2301 ■	7	2900	38
1918MAN	324	2095R	338	2155R	69	2229	28	2302 ■	7	2901	38
1919	328	2114CPRKIT	21	2156R	23	2230	14	2303 ■	8	2902	38
1920	216	2114CPRKIT	210	2156R	69	2230V	15	2304 ■	7	2931	38
1921OG	326	2114CPRKIT	291	2157R	24	2230X	14	2305 ■	7	2932	38
1921OM	326	2116CPRKIT	21	2157R	70	2231	14	2306 ■	7	2940	38
1921OP	326	2116CPRKIT	210	2158	24	2231V	15	2307 ■	8	2941	39
1922	203	2116CPRKIT	291	2158	70	2232	17	2310	4	2942	38
1923	327	2120R	20	2160	23	2233	17	2311	4	2944	39
1923FL	327	2120R	208	2160	69	2240G	57	2320	5	2944	70
1924	327	2120R	290	2161	23	2241G	57	2320AF	29	2944K	70
1926	349	2121	18	2161	69	2245	31	2321	5	2945	39
1927	322	2121CP	18	2162SUN	374	2246	31	2321AF	29	2946GR	39
1927M	323	2121CP	338	2163	68	2247CK	31	2325T	6	2947	39
1927MAN	323	2121CPT	18	2180	18	2258AF	29	2326T	6	2948	43
1927SUN	375	2121R	18	2180CP	19	2262G	60	2330SUN	374	2950	45
1928	322	2121R	207	2180CPR	19	2263	27	2331SUN	374	2953	45
1928MAN	324	2121R	290	2180CPR	208	2263AF	29	2340	35	2954	45
1929	328	2121RSAC	18	2181CPR	24	2263CK	27	2360	2	2955	43
1930	216	2121RSAC	209	2181CPR	70	2263G	60	2360R07	11	2956	43
1931	216	2121RSAC	290	2181CPR	208	2263SET	33	2361	2	2959	43
1931	298	2133	40	2182	19	2264AF	32	2361R07	11	2960	47
1935	366	2133	219	2182	209	2265AF	32	2370	2	2960PR	47
1937	399	2134	40	2182R	19	2266	27	2370AF	29	2960PR	95
1937	402	2134	219	2182R	207	2266AF	30	2370G07	55	2960PR	117
1939	217	2134SUN	378	2182R	290	2266AFCH	33	2370R07	11	2960SET	47
1939	294	2135 ■	41	2182RSAC	20	2266AFCO	33	2371	2	2960SET	95

■ Noutati

INDICE

ART	PAG	ART	PAG	ART	PAG	ART	PAG	ART	PAG	ART	PAG
2960SET	117	3054	206	3227DX	239	3338	261	3471CR	165	3879R	282
2961	48	3055	206	3227SX	239	3339	213	3472	167	3879RBYD	282
2961SET	47	3100N	362	3228DX	238	3340C	260	3472W	163	3880GPF	342
2961SET	95	3107N	362	3228SX	238	3341	213	3473	167	3880GSM	342
2961SET	117	3108N	362	3230EXCEL	255	3342	260	3473W	163	3887	309
2962	54	3110N	362	3231EXCEL	254	3345N	260	3474	163	3888	309
2963SET	47	3120N	360	3231EXPTFE	254	3350	261	3474	167	3889	309
2963SET	95	3130N	359	3233EXCEL	254	3350	348	3475	164	3890P	309
2963SET	117	3131N	359	3235EXCEL	254	3351	261	3475	167	3890P	343
2964	48	3135N	359	3236EXCEL	254	3351	348	3500	50	3890PG3	373
2964Z	48	3136N	359	3236EXPTFE	254	3352	261	3501	367	3890PG4	373
2965	48	3140	360	3260	253	3352	292	3506	50	3890PU	343
2965PROL	48	3141	345	3261	252	3352	348	3506SUN	374	3890PV	343
2966	46	3142	344	3261KIT01	255	3353G	390	3510	51	3890PW2	309
2967	48	3142T	345	3261KITRO1	255	3365N	258	3600	51	3890PW2	343
2970	48	3144	330	3263	252	3370K	258	3606	51	3890PW4	373
2971SET	47	3144ISOL	330	3265	252	3371K	258	3650	52	3890PW5	343
2971SET	95	3144MAG	331	3266	252	3375K	258	3651	52	3890SKIT	308
2971SET	117	3145	360	3266KIT01	255	3376K	258	3660	52	3890TTVD	302
2990G	49	3146KIT	344	3266KITRO1	255	3381KDX	256	3665	52	3890TTVD	350
2990G	211	3146OR	345	3266PTFE	252	3381KSX	256	3670	53	3890VD	302
2990G	292	3146X	345	3300	240	3383K	256	3670	361	3890VD	350
2991SUN	374	3148	344	3300ATTR	261	3383SOND	258	3681	51	3890VDKIT	302
3000X	379	3148A	345	3300C	243	3384K	257	3855X	288	3891G0001	309
3001KB	379	3149	345	3301	240	3386K	257	3856N	285	3891N	286
3001X	379	3149HF	345	3301C	243	3387K	257	3856X	288	3891N	289
3002X	379	3150	344	3302	241	3388K	257	3865X	288	3891NBY	286
3003KB	380	3154	344	3303	241	3390RID	259	3866N	285	3891NBY	289
3004X	380	3154C	344	3303KIT04	249	3391	259	3866X	288	3891NBYD	286
3005X	380	3155	346	3303KIT04R	249	3391BY	259	3868G	304	3891NBYJ	286
3007KB	380	3155POL	346	3305	240	3393	259	3868GHTPP2	304	3891NBYJ	289
3011X	379	3160GN	329	3305C	243	3393BY	259	3868GHTPP3	305	3891NJ	286
3015	380	3161	329	3306	240	3460CR	165	3871XT	287	3891NJ	289
3018KB	380	3165	330	3306C	243	3460W	162	3873BYD	279	3894VDSUN	378
3023	201	3165ISOL	330	3307	241	3461CR	165	3873J	279	3895KCL	299
3023RAC	201	3167ISOL	331	3308	241	3461W	162	3873RBYDJ	280	3895KPF	299
3033	201	3170	329	3308KIT04	249	3462CR	165	3873RJ	280	3896PF	307
3035	201	3175CT	325	3308KIT04R	249	3462W	162	3874	296	3896PFBYD	307
3046	205	3175ISOL	325	3312	238	3463CR	166	3874ISOL	296	3896PFHT	307
3047	205	3177	324	3313	238	3463W	162	3874P	206	3896PFHTBYD	307
3048	205	3177X	324	3320	251	3464CR	165	3874P	296	3898I	298
3049	283	3177XSUN	375	3321	251	3464W	162	3875XT	287	3898IHT	298
3049I	283	3180	363	3325	251	3465CR	166	3877	281	3898KHT	298
3049KIT01	284	3180C	329	3326	251	3465W	162	3877BYD	281	3898N	298
3049KIT01J	284	3200X	382	3330	242	3466CR	166	3877R	282	3899G3	300
3049KIT02D	284	3201KB	382	3330C	244	3467CR	167	3877RBYD	282	3899G3BY	300
3049KIT02JD	284	3201X	382	3331	242	3467W	163	3878	279	3900C	44
3049SKIT	218	3202X	382	3331C	244	3468CR	166	3878BYD	279	3901C	44
3049SKIT	308	3203KB	383	3335	242	3468W	163	3878R	280	3902C	44
3050	283	3204X	382	3335C	244	3469CR	166	3878RBYD	280	3903C	44
3050I	283	3205X	382	3336	242	3469W	163	3879	281	3905C	46
3053	206	3211X	382	3336C	244	3470CR	166	3879BYD	281	3906C	44

■ Noutati

INDICE

ART	PAG	ART	PAG	ART	PAG	ART	PAG	ART	PAG
3907C	44	4735E	372	5540G4M8	335	9536	41	H9300	92
3908C	45	4736SONDA	372	5540G5M6	335	9536	220	H9302	199
3909C	46	4737	364	5540G5M10	335	9537	40	H9602	33
3910	46	4737SUN	376	5540G6M8	335	9537	219	H9604	33
3911	46	4738	364	5540G6M12	336	9550	260	H9705	261
3912	46	4738KIT	376	5540G7M8	336	9551	245	H9706CAP	261
3916C	45	4738KIT01	364	5540G7M14	336	9552NX	260	H9706CV	261
3925C	46	4738KR	365	5540X	331	9552P06	260	H9708	211
3992	49	4738SUN	376	5540X	331	9553	245	H9708	292
3992OT	49	4739	364	5542GS	341	9553AM1	245	H9709	211
3992PAL	49	4739SUN	376	6535DN	351	9553AM2	245	H9709	292
3994	48	4744	371	6535DNISOL	357	9553C	245	HEAT-DUAL1 ■	402
3996L	49	4745	370	6535DNMANOP357		9553CHT	245	HEAT-DUAL1K	402
3996T	49	4745C	372	6535ET	358	9553INS	245	HEAT-DUAL5K	399
3997	45	4745E	370	6535G	351	9556	245	HEAT-EVO1 ■	395
4490	250	4745MANOP	343	6535ISOL	357	9556USB	245	HEAT-EVO1DYN ■	
4490C	250	4745MANOP	373	6535PP	357	9556W	247	397	
4491	250	4745R	371	6536	358	9556W	315	HEAT-EVO2 ■	395
4491C	250	4745TRMF	371	6538	355	9558	245	HEAT-EVO3 ■	396
4492	250	4746	183	6539	355	9561KIT01	308	HEAT-EVO4 ■	396
4492C	250	4746	378	6540	356	9561KIT02	342	HEAT-EVO5 ■	399
4500	271	4746KIT	378	6541CC	352	9561T	390	PCONT01	58
4500N ■	271	4747	372	6542ATT	358	9562SERV	342	PCONT01SER	58
4501PAN	275	4748D	372	6542CC	353	9564RS	246	PCONT02	58
4503	277	4749E	373	6542CCS	354	9564RS	317	PCONT02SER	58
4507	276	4749FLOW	372	6542PP	357	9564ST	246	PCONT03	58
4508	277	4749FLOWE	372	6542SERV	358	9564ST	317	PCONT03SER	58
4522	278	5532HYBRID	349	6542SERV2	358	9564W	246	PCONT04	58
4522A	278	5532PDC	349	6543CH	357	9564W	317	PCONT04SER	58
4524GRF	271	5533	293	6545CH	357	9567	211	PCONT05	59
4527	276	5533ISOL	293	6560C	400	9567	292	PCONT05SER	59
4528PANGRF	273	5534G	341	6560C	402	9567	308	PCONT06	59
4530	149	5534G3P	341	6560CUW	400	9567	312	PCONT07	59
4530	159	5535DIFF	342	6560CUW	402	9567KIT	207	PCONT07SER	59
4530	278	5535G	339	6560CW	400	9567KIT	297	PCONT08	59
4532	277	5535G3P	340	6560CW	402	9568	262	R616	188
4535	278	5535GPF	339	6561C	400	9568	312	R616NAS	188
4539	277	5536G	340	6561CR	400	9569SERV	342		
4540	276	5536GS	341	6561E	400	9575	312		
4601	247	5537KIT	343	6561HR	400	9580	312		
4601	315	5538G2M3	332	6561MM	400	9580W	247		
4606	315	5538G2M4	332	6561MR	400	9580W	315		
4607	315	5538G3M4	333	6568C	400	9581	312		
4612	315	5538G3M6	333	6568C	402	9582U	314		
4625D	313	5538G4M6	333	7166	332	9583CU	314		
4626D ■	313	5538G4M8	333	7167	332	9587	312		
4712LPS	373	5538X	331	7169	327	9589	318		
4722KITFX	373	5539X	331	8930IM	384	9590	318		
4729 ■	293	5540G2M4	334	8930SET	384	9591	318		
4730V	378	5540G3M4	334	9341SET	384	9592	318		
4731ANTIG	378	5540G3M6	334	9535	40	H8996	211		
4732	351	5540G4M6	334	9535	219	H9300	67		

■ Noutati

01 ROBINETI CU SFERA DIN ALAMA



01A Vane si robineti pentru apa

Robineti cu sfera "MISTRAL"		2
Robineti cu sfera "SCIROCCO" cu trecere totala		6
Robineti cu sfera "ODIN" cu trecere totala și presetupa reglabila		7
Robineti cu sfera "BURAN" cu trecere totala și presetupa reglabila		9
Robineti cu sfera "TORNADO" ISO 7/EN 10226		11
Robineti cu sfera "URAGANO" cu trecere totala		13
Robineti cu sfera pentru colectoare		18
Robineti cu capete de compresiune/presare		22
Robineti cu sfera pentru apa		27
Robineti "WATERWORKS"		29
Robineti cu sfera dublu serviciu "EOLO"		36
Robineti cu sertar		37
Minirobineti cu sfera cromata "SMALL"		38
Minirobineti cu sfera "SMALL"		39
Robineti cu sfera, motorizati		40
Robineti cu sfera pentru aplicatii speciale		43
Supape de sens		50
Filtre Y		53

Până la terminarea stocului

01B Vane si robineti pentru gaz

Robineti cu sfera "TORNADO" pentru gaz		55
Robineti cu sfera "URAGANO" pentru gaz - EN 331		56
Robineti de instalat dupa montarea contorului de gaz		58
Robineti cu sfera pentru gaz		60



2360



Robinet F/F ISO 228 cu maneta de aluminiu de culoare rosie și neagră

Cod	Dimensiune	Pret €	Ambalare
 maneta tip levier rosie			
236 0010	1/2"		25/100
236 0007	3/4"		15/60
236 0005	1"		12/48
236 0008	1"1/4		8/32
236 0009	1"1/2		4/16
236 0004	2"		2/8
 maneta tip levier neagră			
236 0175	1/2"		25/100
236 0176	3/4"		15/60
236 0177	1"		12/48
236 0184	1"1/4		8/32
236 0185	1"1/2		4/16
236 0186	2"		2/8



2361



Robinet M/F ISO 228 cu maneta de aluminiu de culoare rosie și neagră

Cod	Dimensiune	Pret €	Ambalare
 maneta tip levier rosie			
236 0015	1/2"		25/100
236 0019	3/4"		15/60
236 0014	1"		12/48
236 0023	1"1/4		8/32
236 0029	1"1/2		4/16
236 0026	2"		2/8
 maneta tip levier neagră			
236 0178	1/2"		25/100
236 0179	3/4"		15/60
236 0180	1"		12/48
236 0187	1"1/4		8/32
236 0188	1"1/2		4/16
236 0189	2"		2/8



2370



Robinet F/F ISO 228 cu maneta tip fluture de culoare rosie și neagră

Cod	Dimensiune	Pret €	Ambalare
 maneta tip fluture rosie			
236 0002	1/2"		25/100
236 0003	3/4"		15/60
236 0012	1"		12/48
236 0035	1"1/4		8/32
 maneta tip fluture neagră			
236 0190	1/2"		25/100
236 0191	3/4"		15/60
236 0192	1"		12/48
236 0193	1"1/4		8/32



2371

Robinet M/F ISO 228 cu maneta tip fluture de culoare rosie și neagră

Cod	Dimensiune	Pret €	Ambalare
 maneta tip fluture rosie			
236 0001	1/2"		25/100
236 0006	3/4"		15/60
236 0011	1"		12/48
236 0031	1"1/4		8/32
 maneta tip fluture neagră			
236 0182	1/2"		25/100
236 0183	3/4"		15/60
236 0181	1"		12/48
236 0194	1"1/4		8/32



2372

Robinet M/M ISO 228 cu maneta tip fluture de culoare rosie

Cod	Dimensiune	Pret €	Ambalare
 maneta tip fluture rosie			
236 0032	1/2"		25/100
236 0038	3/4"		15/60
236 0040	1"		12/48
236 0048	1"1/4		8/32

DIMENSIUNI

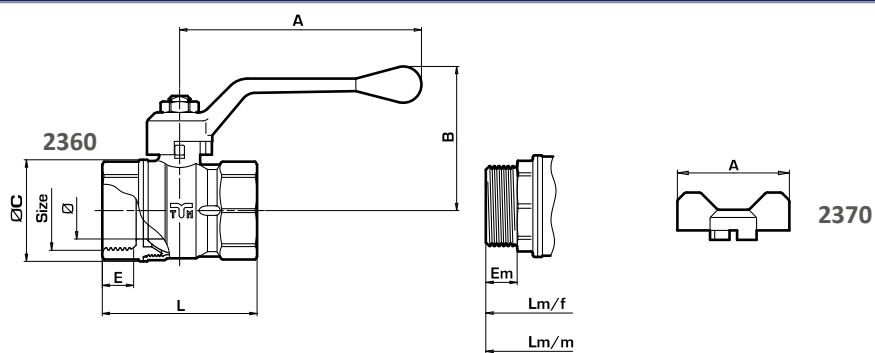



Dimensiune	1/2"	3/4"	1"	1"1/4	1"1/2	2"
Ø (DN)	14	18	23,5	30	37,5	47
A	85	85	100	100	140	140
A 2370	50	50	65	65	-	-
B	48	52,5	59,5	64,5	76	89
ØC	27,5	33,5	42	53	64	79
E	11	11	14	15	16	17,5
L	45	52,5	64	74	85	98
Em	10	10	13	14	15	16,5
Lm/f	51,5	57,5	68,5	81	92	107
Lm/m	50	55,5	66,5	79	-	-
PN	40	30	30	25	25	25

Toate dimensiunile cu exceptia PN-ului sunt exprimate in mm



2310

Robinet F/F ISO 228 cu maneta de aluminiu de culoare rosie neagră și albastra

Cod	Dimensiune	Pret €	Ambalare
 maneta tip levier rosie			
231 0045	1/4" ISO7		25/100
231 0034	3/8" ISO7		25/100
231 0002	1/2"		20/80
231 0008	3/4"		15/60
231 0001	1"		10/40
231 0005	1"1/4		4/16
231 0009	1"1/2		4/16
231 0004	2"		2/8
231 0037	2" 1/2		1/4
231 0021	3"		1/3
231 0027	4"		1/1
 maneta tip levier neagră			
231 0145	1/4" ISO7		25/100
231 0059	3/8" ISO7		25/100
231 0146	1/2"		20/80
231 0147	3/4"		15/60
231 0148	1"		10/40
231 0149	1"1/4		4/16
231 0150	1"1/2		4/16
231 0151	2"		2/8
231 0152	2" 1/2		1/4
231 0153	3"		1/3
231 0154	4"		1/1
 maneta tip levier albastra			
231 0400	1/4" ISO7		25/100
231 0377	3/8" ISO7		25/100
231 0365	1/2"		20/80
231 0366	3/4"		15/60
231 0367	1"		10/40
231 0368	1"1/4		4/16
231 0369	1"1/2		4/16
231 0370	2"		2/8
231 0384	2" 1/2		1/4
231 0385	3"		1/3
231 0386	4"		1/1

Noutati



2311

Robinet M/F ISO 228 cu maneta de aluminiu de culoare rosie neagră și albastra

Cod	Dimensiune	Pret €	Ambalare
 maneta tip levier rosie			
231 0054	1/4" ISO7		25/100
231 0041	3/8" ISO7		25/100
231 0013	1/2"		25/100
231 0014	3/4"		10/40
231 0011	1"		10/40
231 0018	1"1/4		4/16
231 0025	1"1/2		3/12
231 0023	2"		2/8
 maneta tip levier neagră			
231 0071	1/4" ISO7		25/100
231 0072	3/8" ISO7		25/100
231 0155	1/2"		25/100
231 0156	3/4"		10/40
231 0157	1"		10/40
231 0158	1"1/4		4/16
231 0159	1"1/2		3/12
231 0160	2"		2/8
 maneta tip levier albastra			
231 0371	1/2"		25/100
231 0372	3/4"		10/40
231 0373	1"		10/40
231 0374	1"1/4		4/16
231 0375	1"1/2		3/12
231 0376	2"		2/8





LISTA DE PRETURI



2320

Robinet F/F ISO 228 cu maneta tip fluture de culoare rosie neagră și albastra

Cod	Dimensiune	Pret €	Ambalare
 maneta tip fluture rosie			
231 0053	1/4" ISO7		25/100
231 0020	3/8" ISO7		25/100
231 0010	1/2"		25/100
231 0012	3/4"		20/80
231 0016	1"		10/40
 maneta tip fluture neagră			
231 0087	1/4" ISO7		25/100
231 0088	3/8" ISO7		25/100
231 0161	1/2"		25/100
231 0162	3/4"		20/80
231 0163	1"		10/40
 maneta tip fluture albastra			
231 0210	3/8" ISO7		25/100
231 0084	1/2"		25/100
231 0085	3/4"		20/80
231 0086	1"		10/40



2321

Robinet M/F ISO 228 cu maneta tip fluture de culoare rosie neagră și albastra

Cod	Dimensiune	Pret €	Ambalare
 maneta tip fluture rosie			
231 0052	1/4" ISO7		25/100
231 0022	3/8" ISO7		25/100
231 0003	1/2"		25/100
231 0006	3/4"		20/80
231 0007	1"		10/40
 maneta tip fluture neagră			
231 0164	1/4" ISO7		25/100
231 0100	3/8" ISO7		25/100
231 0165	1/2"		25/100
231 0166	3/4"		20/80
231 0167	1"		10/40
 maneta tip fluture albastra			
231 0097	1/2"		25/100
231 0098	3/4"		20/80
231 0099	1"		10/40

01A ROBINETI CU SFERA "SCIROCCO" CU TRECERE TOTALA



2325T

Robinet SCIROCCO feminin/
feminin ISO228 cu maner din
plastic in forma "T"

Cod	Dimensiune	Pret €	Ambalare
231 0344	1/2"		10/40
231 0345	3/4"		8/32
231 0346	1"		6/24



2326T

Robinet SCIROCCO masculin/
feminin ISO228 cu maner din
plastic in forma "T"

Cod	Dimensiune	Pret €	Ambalare
231 0347	1/2"		10/40
231 0348	3/4"		8/32
231 0349	1"		6/24

DIMENSIUNI

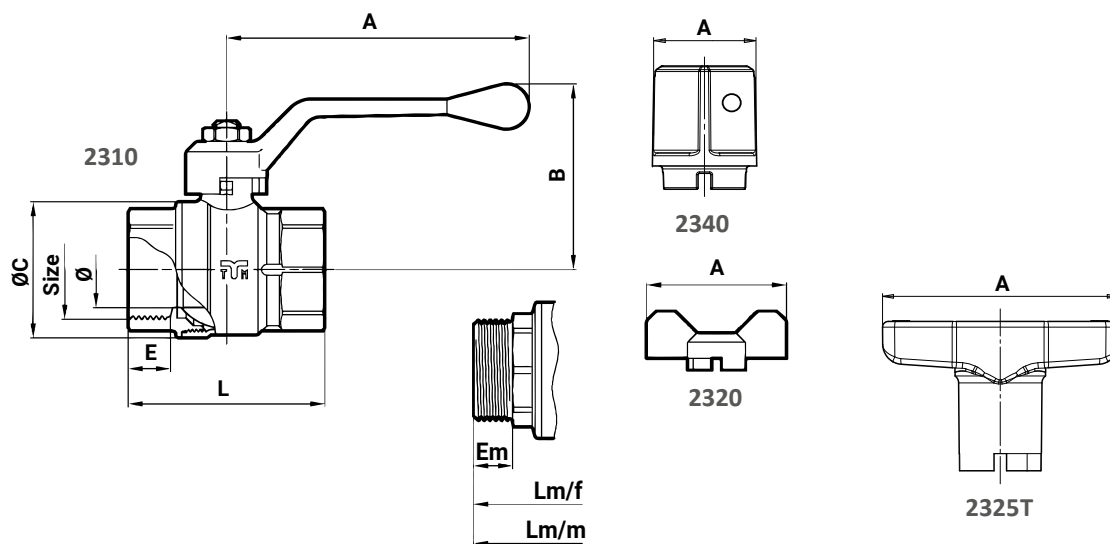

Dimensiune	1/4"	3/8"	1/2"	3/4"	1"	1 1/4"	1 1/2"	2"	2 1/2"	3"	4"
Ø (DN)	10	10	15	20	25	32	40	50	60	74	94
A	85	85	85	85	100	140	140	140	240	240	240
A 2320	50	50	50	50	65	-	-	-	-	-	-
A 2340	-	-	36	-	-	-	-	-	-	-	-
A 2325T	-	-	82	82	82	-	-	-	-	-	-
B	46	46	51,5	54,5	61,5	73	79	91,5	118	128	142
B 2325T	-	-	70	72,5	78,5	-	-	-	-	-	-
ØC	23	23	30	37	45	55	68	84	103	124	152
E	10	12	13,5	14,5	14	15	16	17,5	21,5	23,5	27
L	42	47	53	60,5	65	77,5	89	103	130	149	178
Em	11	11,5	10	12	13	14	15	16,5	-	-	-
Lm/f	43	57	56,5	64	70	85,5	96,5	114	-	-	-
Lm/m	-	56	53,5	59,5	69	84	96,5	114	-	-	-
PN	50	50	50	40	40	30	30	25	18	16	16

Toate dimensiunile cu exceptia PN-ului sunt exprimate in mm



NOUȚĂȚI



2300

Robinet ODIN F/F ISO 228 cu presetupă reglabilă și manetă de aluminiu de culoare neagră

Sigilabila

Cod	Dimensiune	Pret €	Ambalare
230 0001	1/2"		20/80
230 0002	3/4"		14/56
230 0003	1"		6/24
230 0004	1"1/4		4/16
230 0005	1"1/2		2/8
230 0006	2"		2/8
231 0152	2" 1/2		1/4
231 0153	3"		1/3
231 0154	4"		1/1

NOUȚĂȚI



2301

Robinet ODIN M/F ISO 228 cu presetupă reglabilă și manetă de aluminiu de culoare neagră

Sigilabila

Cod	Dimensiune	Pret €	Ambalare
230 0007	1/2"		20/80
230 0008	3/4"		14/56
230 0009	1"		6/24
230 0010	1"1/4		4/16
230 0011	1"1/2		2/8
230 0012	2"		1/4

NOUȚĂȚI



2302

Robinet ODIN M/M ISO 228 cu presetupă reglabilă și manetă de aluminiu de culoare neagră

Sigilabila

Cod	Dimensiune	Pret €	Ambalare
230 0013	1/2"		20/80
230 0014	3/4"		14/56
230 0015	1"		6/24

NOUȚĂȚI



2304

Robinet ODIN F/F ISO 228 cu presetupă reglabilă și manetă tip fluture de culoare neagră

Sigilabila

Cod	Dimensiune	Pret €	Ambalare
230 0021	1/2"		24/96
230 0022	3/4"		14/56
230 0023	1"		10/40
230 0024	1"1/4		5/20

NOUȚĂȚI



2305

Robinet ODIN M/F ISO 228 cu presetupă reglabilă și manetă tip fluture de culoare neagră

Sigilabila

Cod	Dimensiune	Pret €	Ambalare
230 0025	1/2"		20/80
230 0026	3/4"		14/56
230 0027	1"		8/32
230 0028	1"1/4		4/16

NOUȚĂȚI



2306

Robinet ODIN M/M ISO 228 cu presetupă reglabilă și manetă tip fluture de culoare neagră

Sigilabila

Cod	Dimensiune	Pret €	Ambalare
230 0029	1/2"		20/80
230 0030	3/4"		14/56
230 0031	1"		8/32

NOUȚĂȚI

**2303**

Robinet ODIN M/F ISO 228 cu presetupă reglabilă, manetă de aluminiu de culoare neagră și racord olandez

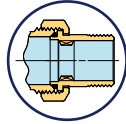

Cod	Dimensiune	Pret €	Ambalare
230 0017	1/2"		12/48
230 0018	3/4"		8/32
230 0019	1"		4/16
230 0020	1"1/4		2/8

NOUȚĂȚI

**2307**

Robinet ODIN M/F ISO 228 cu presetupă reglabilă, manetă tip fluture de culoare neagră și racord olandez

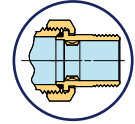

Cod	Dimensiune	Pret €	Ambalare
230 0033	1/2"		14/56
230 0034	3/4"		10/40
230 0035	1"		6/24
230 0036	1"1/4		3/12

DIMENSIUNI

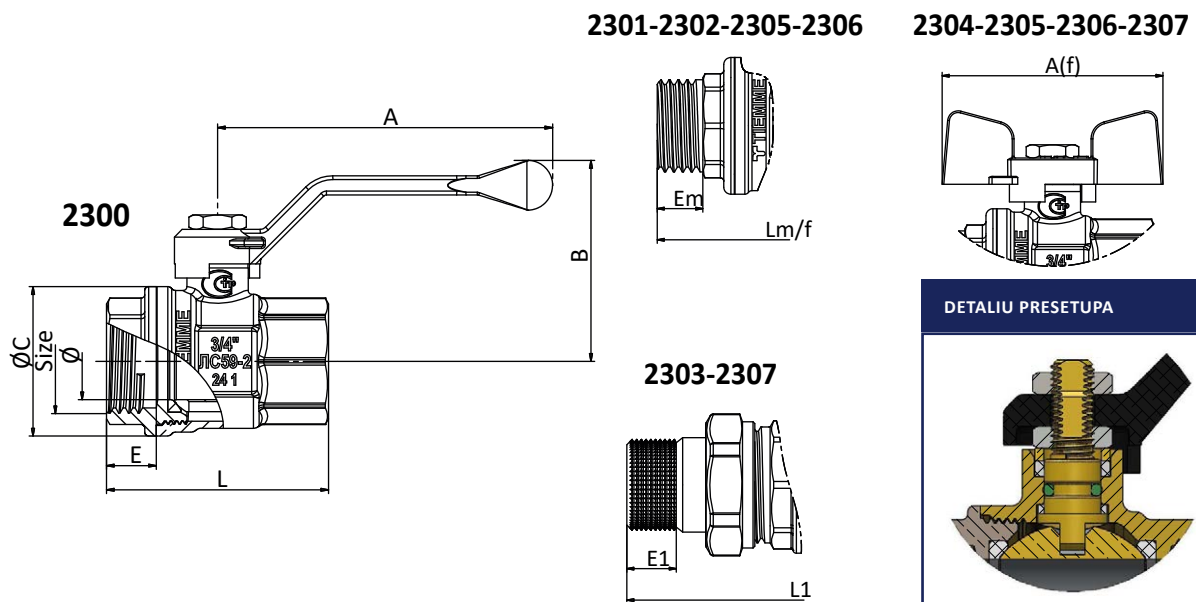

Dimensiune	1/2"	3/4"	1"	1"1/4	1"1/2	2"	2"1/2	3"	4"
Ø (DN)	15	20	25	32	40	50	60	74	94
A	88	88	131,5	131,5	154	154	240	240	240
A(f)	53	63	73	73	-	-	-	-	-
B	49	52	63	69	86	93	118	128	142
Ø C	32,5	39	47,5	59	72,5	87,5	103	124	152
E	11	13	15	17	18	20	21,5	23,5	27
E1	14,3	14	16	15	-	-	-	-	-
L	50	58	68,5	81	94	108	130	149	178
L1	84	95,5	110	127	-	-	-	-	-
Em	11	13	15	17,5	18,5	20	-	-	-
Lm/f	59	67	78	91	101	116,5	-	-	-
Lm/m	60	70	80	-	-	-	-	-	-
PN	40	40	40	25	25	25	18	16	16

Toate dimensiunile cu exceptia PN-ului sunt exprimate in mm





2450

Robinet BURAN F/F ISO 228 cu presetupă reglabilă și manetă de aluminiu de culoare neagră



Cod	Dimensiune	Pret €	Ambalare
245 0007	1/2"		20/80
245 0008	3/4"		15/60
245 0009	1"		8/32
245 0023	1"1/4		4/16
245 0024	1"1/2		3/12
245 0025	2"		2/8
231 0152	2" 1/2		1/4
231 0153	3"		1/3
231 0154	4"		1/1



2461

Robinet BURAN M/F ISO 228 cu presetupă reglabilă și manetă tip fluture de culoare neagră



Cod	Dimensiune	Pret €	Ambalare
245 0016	1/2"		25/100
245 0017	3/4"		15/60
245 0018	1"		10/40
245 0030	1"1/4		5/20



2451

Robinet BURAN M/F ISO 228 cu presetupă reglabilă și manetă de aluminiu de culoare neagră



Cod	Dimensiune	Pret €	Ambalare
245 0013	1/2"		20/80
245 0014	3/4"		15/60
245 0015	1"		8/32
245 0027	1"1/4		4/16
245 0028	1"1/2		3/12
245 0029	2"		2/8



2471

Robinet BURAN M/F ISO 228 cu presetupă reglabilă, manetă de aluminiu de culoare neagră și racord olandez

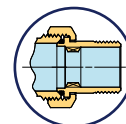

Cod	Dimensiune	Pret €	Ambalare
245 0001	1/2"		15/60
245 0002	3/4"		10/40
245 0003	1"		6/24
245 0019	1"1/4		4/16
245 0020	1" 1/2		1/4
245 0021	2"		1/2



2460

Robinet BURAN F/F ISO 228 cu presetupă reglabilă și manetă tip fluture de culoare neagră



Cod	Dimensiune	Pret €	Ambalare
245 0010	1/2"		25/100
245 0011	3/4"		15/60
245 0012	1"		10/40
245 0026	1"1/4		5/20



2472

Robinet BURAN M/F ISO 228 cu presetupă reglabilă, manetă tip fluture de culoare neagră și racord olandez

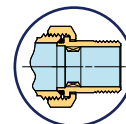

Cod	Dimensiune	Pret €	Ambalare
245 0004	1/2"		15/60
245 0005	3/4"		10/40
245 0006	1"		7/28
245 0022	1"1/4		5/20

DIMENSIUNI

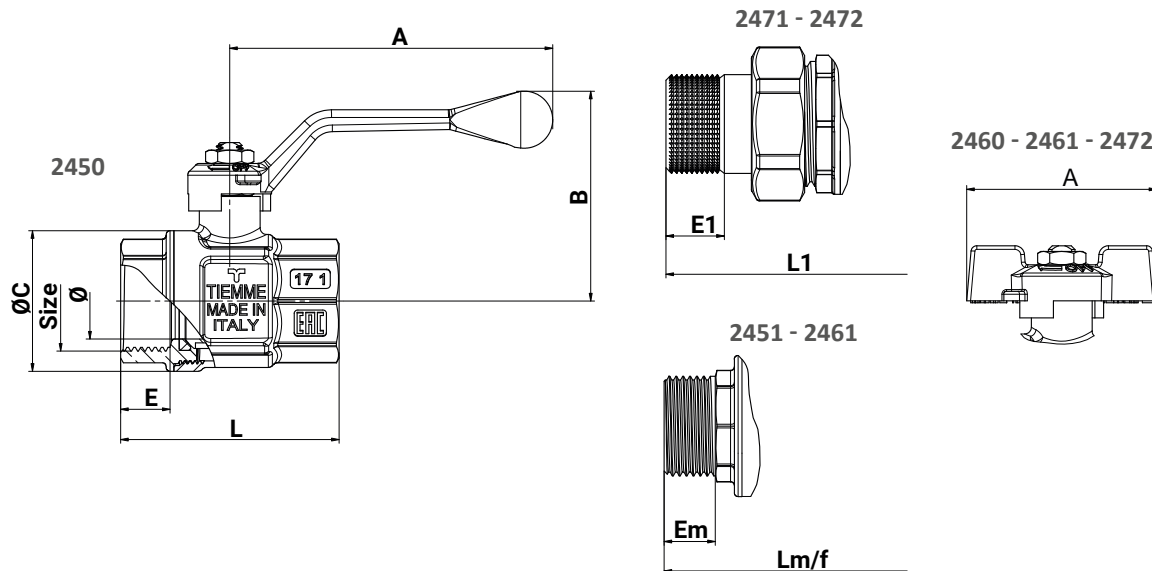

Dimensiune	1/2"	3/4"	1"	1"1/4	1"1/2	2"	2"1/2	3"	4"
Ø (DN)	15	20	25	32	40	50	60	74	94
A	85	85	100	100	160	160	240	240	240
A2460	50	50	65	65	-	-	-	-	-
B	52	55,2	62,5	68	88,5	99	118	128	142
Ø C	30	37	45	57	68	84	103	124	152
E	12	13	15	16,5	16	17,5	21,5	23,5	27
E1	12,5	14	16	15	18	18	21,5	23,5	27
L	50	57,5	68	81,5	89	103,5	130	149	178
L1	79,5	89,5	104	122	133,5	154,5	130	149	178
Em	11,5	13,5	14,5	17	15	16,5	-	-	-
Lm/f	56,5	64	76	90	96,5	114,5	-	-	-
PN	64	50	50	50	40	40	18	16	16

Toate dimensiunile cu excepția PN-ului sunt exprimate în mm

DETALIU PRESETUPA

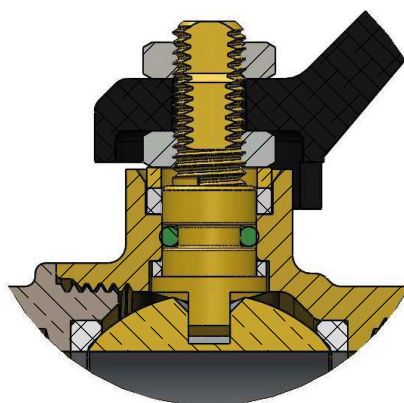



2360R07

Robinet F/F ISO 7/EN 10226 cu maneta de aluminiu de culoare rosie și neagră

Cod	Dimensiune	Pret €	Ambalare
 maneta tip levier rosie			
238 0010	1/2"		20/80
238 0008	3/4"		15/60
238 0002	1"		8/32
238 0013	1"1/4		4/16
238 0014	1"1/2		3/12
238 0003	2"		2/8
 maneta tip levier neagră			
238 0043	1/2"		20/80
238 0034	3/4"		15/60
238 0051	1"		8/32
238 0044	1"1/4		4/16
238 0035	1"1/2		3/12
238 0036	2"		2/8



2361R07



Robinet M/F ISO 7/EN 10226 cu maneta de aluminiu de culoare rosie și neagră

Cod	Dimensiune	Pret €	Ambalare
 maneta tip levier rosie			
238 0016	1/2"		20/80
238 0012	3/4"		10/40
238 0011	1"		8/32
238 0019	1"1/4		6/24
238 0022	1"1/2		3/12
238 0021	2"		2/8
 maneta tip levier neagră			
238 0037	1/2"		20/80
238 0047	3/4"		10/40
238 0038	1"		8/32
238 0048	1"1/4		6/24
238 0049	1"1/2		3/12
238 0050	2"		2/8



2370R07



Robinet F/F ISO 7/EN 10226 cu maneta tip fluture de culoare rosie și neagră

Cod	Dimensiune	Pret €	Ambalare
 maneta tip fluture rosie			
238 0015	1/2"		25/100
238 0017	3/4"		15/60
238 0024	1"		8/32
238 0028	1"1/4		5/20
 maneta tip fluture neagră			
238 0039	1/2"		25/100
238 0045	3/4"		15/60
238 0040	1"		8/32
238 0052	1"1/4		5/20



2371R07

Robinet M/F ISO 7/EN 10226 cu maneta tip fluture de culoare rosie și neagră

Cod	Dimensiune	Pret €	Ambalare
 maneta tip fluture rosie			
238 0001	1/2"		25/100
238 0004	3/4"		15/60
238 0009	1"		8/32
238 0025	1"1/4		6/24
 maneta tip fluture neagră			
238 0041	1/2"		25/100
238 0042	3/4"		15/60
238 0046	1"		8/32
238 0053	1"1/4		6/24

01A ROBINETI CU SFERA "TORNADO" ISO 7/EN 10226



2380R07

Robinet F/F ISO 7/EN 10226 cu maneta de oțel de culoare roșie



2381R07

Robinet M/F ISO 7/EN 10226 cu maneta de oțel de culoare roșie

Cod	Dimensiune	Pret €	Ambalare
238 0006	1/2"		20/80
238 0007	3/4"		14/56
238 0005	1"		10/40
238 0018	1"1/4		6/24
238 0023	1"1/2		3/12
238 0020	2"		2/8

Cod	Dimensiune	Pret €	Ambalare
238 0026	1/2"		20/80
238 0029	3/4"		14/56
238 0027	1"		8/32
238 0030	1"1/4		6/24
238 0031	1"1/2		3/12
238 0032	2"		2/8

DIMENSIUNI

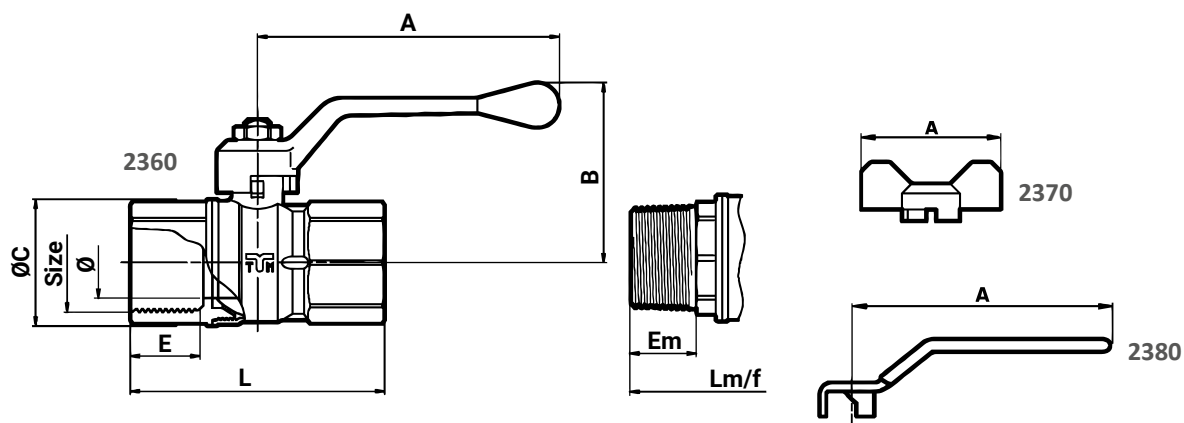

Dimensiune	Mod.	1/2"	3/4"	1"	1" 1/4	1" 1/2	2"
Ø (DN)	toate	14,0	18,0	23,5	30,0	37,5	47,0
A	2360/2361	85,0	85,0	100,0	100,0	140,0	140,0
	2370/2371	50,0	50,0	65,0	65,0	-	-
	2380/2381	85,0	85,0	113,0	113,0	141,0	141,0
B	toate	48,0	52,5	59,5	64,5	76,0	89,0
Ø C	toate	27,5	33,5	42,0	53,0	64,0	79,0
E	ISO7	17,0	18,0	21,5	24,0	24,0	28,5
Em	ISO7	16,5	18,0	21,0	23,5	23,5	28,0
L	ISO7	58,0	66,5	78,0	93,0	101,0	121,0
Lm/f	ISO7	63,5	72,0	83,0	99,1	108,0	129,0
PN		30	30	30	25	25	25

Toate dimensiunile cu excepția PN-ului sunt exprimate în mm



01A ROBINETI CU SFERA "URAGANO" CU TRECERE TOTALA



2210R

Robineti URAGANO F/F ISO7/EN 10226 cu maneta din aluminiu

Cod	Dimensiune	Pret €	Ambalare
 maneta tip levier rosie			
231 0045	1/4"		25/100
231 0034	3/8"		25/100
220 0012	1/2"		15/60
220 0015	3/4"		10/40
220 0007	1"		8/32
220 0019	1"1/4		4/16
220 0014	1"1/2		3/12
220 0009	2"		2/8
220 0073	2"1/2		1/4
220 0074	3"		1/3
220 0077	4"		1/1
 maneta tip levier neagră			
220 0027	1/2"		20/80
220 0038	3/4"		10/40
220 0017	1"		8/32
220 0032	1"1/4		4/16
220 0018	1"1/2		3/12
220 0010	2"		2/8
220 0079	2"1/2		1/4
220 0081	3"		1/3
220 0082	4"		1/1



2211R



Robineti URAGANO M/F ISO7/EN 10226 cu maneta din aluminiu

Cod	Dimensiune	Pret €	Ambalare
 maneta tip levier rosie			
220 0013	1/2"		20/80
220 0016	3/4"		10/40
220 0008	1"		8/32
220 0039	1"1/4		4/16
220 0037	1"1/2		3/12
220 0030	2"		2/8
 maneta tip levier neagră			
220 0041	1/2"		20/80
220 0051	3/4"		10/40
220 0043	1"		8/32
220 0055	1"1/4		4/16
220 0050	1"1/2		3/12
220 0044	2"		2/8



2220R



Robinet F/F ISO 7/EN10226 cu maneta tip fluture de culoare rosie și neagră

Cod	Dimensiune	Pret €	Ambalare
 maneta tip fluture rosie			
231 0053	1/4"		25/100
231 0020	3/8"		25/100
220 0004	1/2"		20/80
220 0006	3/4"		15/60
220 0023	1"		8/32
 maneta tip fluture neagră			
220 0036	1/2"		20/80
220 0048	3/4"		15/60
220 0063	1"		8/32



2221R

Robinet M/F ISO 7/EN10226 cu maneta tip fluture de culoare rosie și neagră

Cod	Dimensiune	Pret €	Ambalare
 maneta tip fluture rosie			
220 0001	1/2"		20/80
220 0005	3/4"		15/60
220 0011	1"		8/32
 maneta tip fluture neagră			
220 0028	1/2"		20/80
220 0033	3/4"		15/60
220 0059	1"		8/32



2230

Robinet F/F ISO 7/EN 10226 cu maneta de otel de culoare rosie

Cod	Dimensiune	Pret €	Ambalare
231 0051	1/4"		25/100
231 0049	3/8"		25/100
220 0026	1/2"		15/60
220 0034	3/4"		10/40
220 0022	1"		8/32
220 0031	1"1/4		4/16
220 0035	1"1/2		3/12
220 0025	2"		2/8
220 0002	2"1/2		1/4
220 0003	3"		1/3
220 0029	4"		1/1



2231

Robinet M/F ISO 7/EN 10226 cu maneta de otel de culoare rosie

Cod	Dimensiune	Pret €	Ambalare
220 0064	1/2"		20/80
220 0068	3/4"		10/40
220 0053	1"		8/32
220 0062	1"1/4		4/16
220 0066	1"1/2		3/12
220 0054	2"		2/8



2230X

Robinet F/F ISO 7/EN 10226 cu maneta de otel inox de culoare rosie

+ MANETA AISI 304

Cod	Dimensiune	Pret €	Ambalare
220 0148	1/2"		15/60
220 0149	3/4"		10/40
220 0150	1"		8/32
220 0151	1"1/4		4/16
220 0152	1"1/2		3/12
220 0153	2"		2/8
220 0154	2"1/2		1/4
220 0155	3"		1/3
220 0156	4"		1/1



2230V

Robinet F/F ISO 7/EN 10226 cu maneta de oțel de culoare verde



+ ANTI - LEGIONELA

Cod	Dimensiune	Pret €	Ambalare
220 0125	1/4"		25/100
220 0126	3/8"		25/100
220 0127	1/2"		15/60
220 0128	3/4"		10/40
220 0129	1"		8/32
220 0130	1"1/4		4/16
220 0131	1"1/2		3/12
220 0132	2"		2/8



2231V

Robinet M/F ISO 7/EN 10226 cu maneta de oțel de culoare verde



+ ANTI - LEGIONELA

Cod	Dimensiune	Pret €	Ambalare
220 0136	1/2"		20/80
220 0137	3/4"		10/40
220 0138	1"		8/32
220 0139	1"1/4		4/16
220 0140	1"1/2		3/12
220 0141	2"		2/8

2230V - 2231V FUNCTIONARE

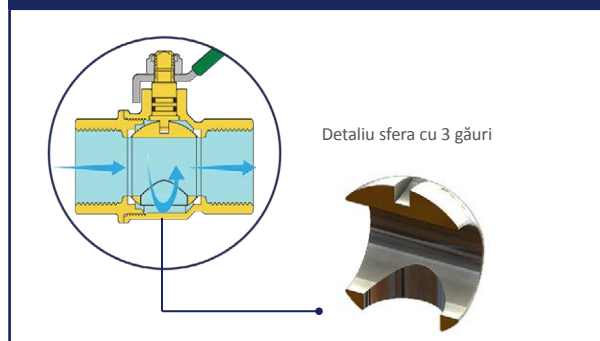

Detaliu sfera cu 3 găuri

01A ROBINETI CU SFERA "URAGANO" CU TRECERE TOTALA

DIMENSIUNI

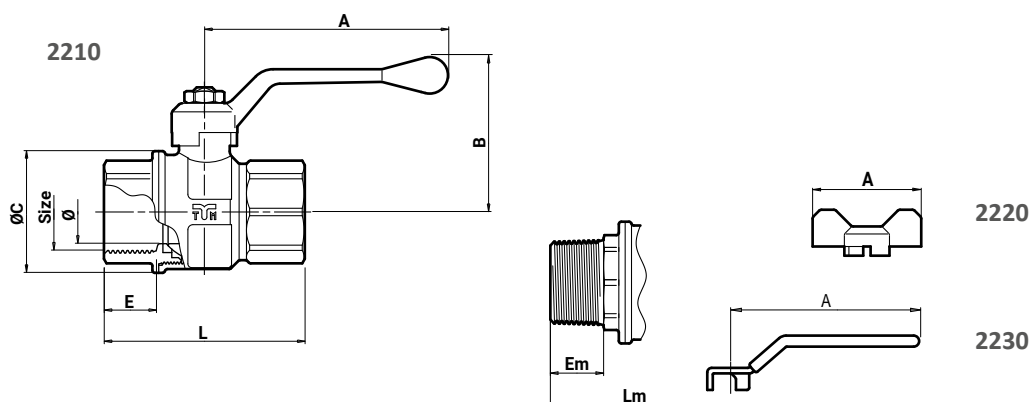

Dimensiune	1/4"	3/8"	1/2"	3/4"	1"	1"1/4	1"1/2	2"	2"1/2	3"	4"
Ø (DN)	10	10	15	20	25	32	40	50	65	80	100
A 2210	85	85	85	100	100	140	140	160	-	-	-
A 2220	50	50	50	65	65	-	-	-	-	-	-
A 2230	85	85	85	113	113	141	141	141	240	240	240
B	39	39	44,5	53,5	57,5	73,5	79,5	92	125,5	136	150,5
ØC	23	23	32,5	39	48	59	71	86	114	131	164
E	10	12	16,5	18	20,6	23,5	23,5	28	34	37	43
L	42	47	59,5	67,5	79	96	105	126	156	177	214
Em	-	-	16,5	18	21	23,5	23,5	28	-	-	-
Lm	-	-	67,5	75,5	87	106	114	136,5	-	-	-
PN	50	50	64	40	40	30	30	30	20	20	20

Toate dimensiunile cu exceptia PN-ului sunt exprimate in mm



01A ROBINETI CU SFERA "URAGANO" CU TRECERE TOTALA



2232

Robinet pentru izolatie F/F ISO 7/EN 10226 cu maneta de otel de culoare rosie



2233

Robinet pentru izolatie M /F ISO 7/EN 10226 cu maneta de otel de culoare rosie

Cod	Dimensiune	Pret €	Ambalare
220 0192	1/2"		12/48
220 0193	3/4"		8/32
220 0194	1"		6/24
220 0195	1"1/4		3/12
220 0196	1"1/2		2/8
220 0197	2"		1/4

Cod	Dimensiune	Pret €	Ambalare
220 0198	1/2"		12/48
220 0199	3/4"		8/32
220 0200	1"		6/24
220 0201	1"1/4		3/12
220 0202	1"1/2		2/8
220 0203	2"		1/4

DIMENSIUNI

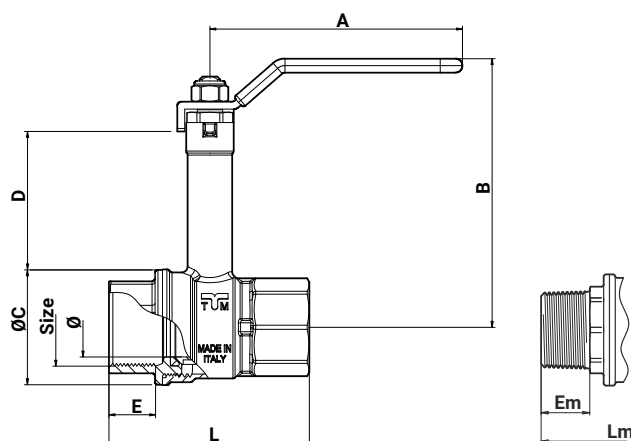

Dimensiune	1/2"	3/4"	1"	1"1/4	1"1/2	2"
Ø (DN)	15	20	25	32	40	50
A	85	85	114	140	140	140
B	88,5	90,5	105,5	131	137	157
ØC	32,5	38,7	48	59	71	86
D	47,8	46,7	47	63	63	75
E	16,5	18	20,6	23,5	23,5	28
L	59,5	67,5	79	95,3	104,5	126
Em	16,5	18	21	23,5	23,5	28
Lm	67,5	75,5	86,6	105,3	113,5	136,5
PN	50	40	40	30	30	25

Toate dimensiunile cu exceptia PN-ului sunt exprimate in mm

Trecere totala



2121

Robinet M/F ISO 228 cu maneta tip fluture de culoare rosie și albastra pentru colectoare și garnitura O-RING

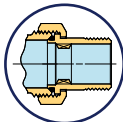

i Disponibil cu maneta tip fluture albastra

Cod	Dimensiune	Pret €	Ambalare
maneta tip fluture rosie			
212 0003	1/2"		20/80
212 0001	3/4"		10/40
212 0002	1"		7/28
212 0004	1"1/4		6/24



2121CP

Robinet M/F ISO 228 cu maneta tip fluture de culoare rosie și albastra pentru colectoare și GARNITURA PLATA

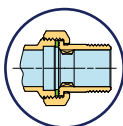

i Disponibil cu maneta tip fluture albastra

Cod	Dimensiune	Pret €	Ambalare
maneta tip fluture rosie			
212 0025	1/2"		20/80
212 0021	3/4"		10/40
212 0015	1"		9/36
212 0024	1"1/4		6/24
212 0122	1"1/2		3/12

Cu maneta aluminiu



2121CPT

Robinet M/F ISO228 cu maner din plastic in forma "T" pentru colectoare și GARNITURA PLATA

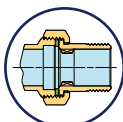

Cod	Dimensiune	Pret €	Ambalare
212 0204	1/2"		10/40
212 0205	3/4"		6/24
212 0206	1"		4/16



2121R

Robinet drept cu olandez și garnitura O-RING, cu pre-etansare

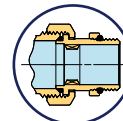

Cod	Dimensiune	Pret €	Ambalare
maneta tip fluture rosie			
212 0155	1/2"		20/80
212 0017	3/4"		10/40
212 0013	1"		9/36
212 0027	1"1/4		6/24
maneta tip fluture albastra			
212 0156	1/2"		20/80
212 0020	3/4"		10/40
212 0014	1"		9/36
212 0028	1"1/4		6/24



2121RSAC

Set robinet drept cu maneta tip fluture de culoare rosie și albastra cu olandez, cu garnitura O-RING cu pre-etansare

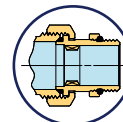

Cod	Dimensiune	Pret €	Ambalare
386 0035	1"		1/10

Nr 1 cu maneta tip fluture de culoare albastra + Nr 1 cu maneta tip fluture de culoare rosie



2180

Robinet M/F de colt ISO 228 cu maneta tip fluture de culoare rosie și albastra pentru colectoare și garnitura O-RING

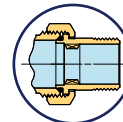

i Disponibil cu maneta tip fluture albastra

Cod	Dimensiune	Pret €	Ambalare
maneta tip fluture rosie			
212 0008	1/2"		15/60
212 0005	3/4"		10/40
212 0006	1"		5/20



LISTA DE PRETURI

Trecere totala



2180CP

Robinet M/F de colt ISO 228 cu maneta tip fluture pentru colectoare si GARNITURA PLATA

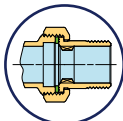

i Disponibil cu maneta tip fluture albastra



Cod	Dimensiune	Pret €	Ambalare
 maneta tip fluture rosie			
212 0035	1/2"		15/60
212 0034	3/4"		10/40
212 0016	1"		5/20

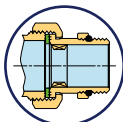

2180CPR

Robinet de colt cu olandez, cu pre-etansare si garnitura GARNITURA PLATA





Cod	Dimensiune	Pret €	Ambalare
 maneta tip fluture rosie			
212 0056	3/4"		10/40
212 0057	1"		5/20
 maneta tip fluture albastra			
212 0054	3/4"		10/40
212 0045	1"		5/20

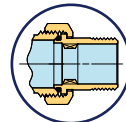

2182

Robinet M/F de colt ISO 228 cu maneta tip fluture pentru colectoare si etansare pe O-RING





Cod	Dimensiune	Pret €	Ambalare
 maneta tip fluture rosie			
212 0046	1/2"		15/60
212 0038	3/4"		10/40
212 0040	1"		5/20
 maneta tip fluture albastra			
212 0047	1/2"		15/60
212 0039	3/4"		10/40
212 0041	1"		5/20

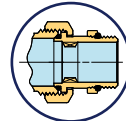

2182R

Robinet M/F de colt ISO 228 cu maneta tip fluture pentru colectoare cu pre-etansare si garnitura O-RING



Cod	Dimensiune	Pret €	Ambalare
 maneta tip fluture rosie			
212 0050	3/4"		10/40
212 0048	1"		5/20
 maneta tip fluture albastra			
212 0049	3/4"		10/40
212 0044	1"		5/20

Trecere totala



2182RSAC

Set robineti M/F de colt ISO 228 cu maneta tip fluture de culoare rosie si albastra pentru colectoare, cu pre-etansare si garnitura O-RING

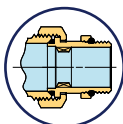

i Nr 1 cu maneta tip fluture de culoare albastra + Nr 1 cu maneta tip fluture de culoare rosie

Cod	Dimensiune	Pret €	Ambalare
386 0032	1"		1/10



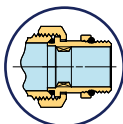

2120R

Robinet drept cu olandez, garnitura O-RING, cu pre-etansare si termometru cu prindere reversibila



BREVETAT

Cod	Dimensiune	Pret €	Ambalare
 maneta tip fluture rosie			
212 0043	1"		5/20
 maneta tip fluture albastra			
212 0042	1"		5/20



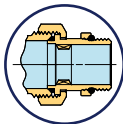

2183R

Robinet M/F de colt ISO 228 cu maneta tip fluture de culoare rosie sau albastra, cu pre-etansare, garnitura O-RING si termometru cu prindere reversibila



BREVETAT

Cod	Dimensiune	Pret €	Ambalare
 maneta tip fluture rosie			
212 0031	1"		5/20
 maneta tip fluture albastra			
212 0032	1"		5/20

TIPOLOGIE OLANDEZI TIEMME

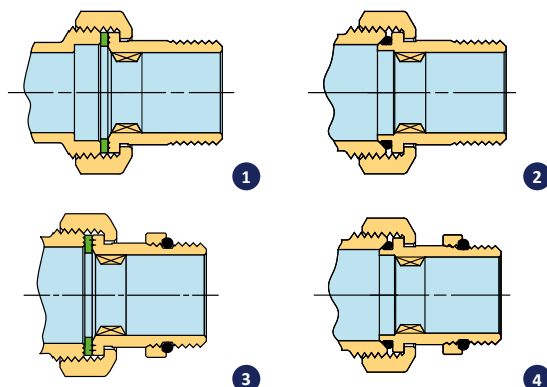

- 1 Olandez cu garnitura plata
- 2 Olandez cu O-Ring
- 3 Olandez cu garnitura plata si pre-etansare
- 4 Olandez cu O-Ring si pre-etansare





2114CPRKIT

Set robineti sfera cu olandez garnitura plata model drept compact, cu maneta tip fluture culoare rosie si albastra si termometre ce au conexiune reversibila

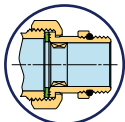

 BREVETAT

Cod	Dimensiune	Pret €	Ambalare
212 0195	1"		1/10



2184CPRKIT

Set robineti sfera cu olandez garnitura plata model coltar compact, cu maneta tip fluture culoare rosie si albastra si termometre ce au conexiune reversibila

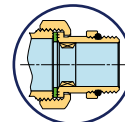

 BREVETAT

Cod	Dimensiune	Pret €	Ambalare
212 0197	1"		1/10



2116CPRKIT

Set robineti sfera cu olandez garnitura plata model drept compact, cu maneta tip fluture culoare rosie si albastra fara termometre

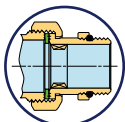

 BREVETAT

Cod	Dimensiune	Pret €	Ambalare
212 0196	1"		1/10



2186CPRKIT

Set robineti sfera cu olandez garnitura plata model coltar compact, cu maneta tip fluture culoare rosie si albastra fara termometre

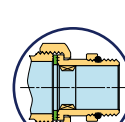

 BREVETAT

Cod	Dimensiune	Pret €	Ambalare
212 0198	1"		1/10

Pentru tub multistrat



2143

Robinet pentru tub multistrat cu maneta de aluminiu de culoare rosie

i Disponibil cu maneta de otel de culoare rosie (2163)



Cod	Dimensiune	Pret €	Ambalare
162 0022	16 x 2,0		20/80
162 0005	20 x 2,0		15/60



2153

Robinet pentru tub multistrat cu maneta tip fluture de culoare rosie și albastra



i Disponibil cu maneta tip fluture albastra

Cod	Dimensiune	Pret €	Ambalare
 maneta tip fluture rosie			
162 0020	16 x 2,0		20/80
162 0003	20 x 2,0		15/60
162 0084	26 x 3,0		10/40
 maneta tip fluture albastra			
162 0021	16 x 2,0		20/80
162 0053	20 x 2,0		15/60
162 0086	26 x 3,0		10/40



2153FLR



Robinet pentru tub multistrat cu maneta tip fluture de culoare rosie și albastra

Cod	Dimensiune	Pret €	Ambalare
 maneta tip fluture rosie			
162 0029	16 x 2,0		20/80
162 0031	20 x 2,0		15/60
 maneta tip fluture albastra			
162 0030	16 x 2,0		20/80
162 0032	20 x 2,0		15/60



2154R



Robinet M pentru tub multistrat cu maneta tip fluture de culoare rosie și albastra

Cod	Dimensiune	Pret €	Ambalare
 maneta tip fluture rosie			
162 0025	16 x 2,0 - 1/2"		20/80
162 0037	20 x 2,0 - 3/4"		15/60
162 0092	26 x 3,0 - 1"		10/40
 maneta tip fluture albastra			
162 0026	16 x 2,0 - 1/2"		20/80
162 0038	20 x 2,0 - 3/4"		15/60
162 0093	26 x 3,0 - 1"		10/40



2154FLR

Robinet M pentru tub multistrat cu maneta tip fluture de culoare rosie și albastra

Cod	Dimensiune	Pret €	Ambalare
 maneta tip fluture rosie			
162 0035	16 x 2,0 - 1/2"		20/80
162 0041	20 x 2,0 - 3/4"		15/60
 maneta tip fluture albastra			
162 0036	16 x 2,0 - 1/2"		20/80
162 0042	20 x 2,0 - 3/4"		15/60





01A ROBINETI CU CAPETE DE COMPRESIUNE/PRESARE

Pentru tub multistrat



2155R



Robinet F pentru tub multistrat cu maneta tip fluture de culoare rosie și albastra

Cod	Dimensiune	Pret €	Ambalare
 maneta tip fluture rosie			
162 0027	16 x 2,0 - 1/2"		20/80
162 0039	20 x 2,0 - 3/4"		15/60
162 0100	26 x 3,0 - 1"		10/40
 maneta tip fluture albastra			
162 0028	16 x 2,0 - 1/2"		20/80
162 0040	20 x 2,0 - 3/4"		15/60
162 0101	26 x 3,0 - 1"		10/40



2155FLR



Robinet F pentru tub multistrat cu maneta tip fluture de culoare rosie și albastra

Cod	Dimensiune	Pret €	Ambalare
 maneta tip fluture rosie			
162 0033	16 x 2,0 - 1/2"		20/80
162 0043	20 x 2,0 - 3/4"		15/60
 maneta tip fluture albastra			
162 0034	16 x 2,0 - 1/2"		20/80
162 0044	20 x 2,0 - 3/4"		15/60



2161



Robinet pentru tub multistrat cu maneta de aluminiu și piulita

Cod	Dimensiune	Pret €	Ambalare
 maneta tip levier rosie			
162 0122	26 x 3,0 - 3/4"		10/40
162 0124	26 x 3,0 - 1"		10/40
 maneta tip levier albastra			
162 0121	26 x 3,0 - 3/4"		10/40
162 0123	26 x 3,0 - 1"		10/40



2160



Robinet pentru tub multistrat cu maneta tip fluture și piulita

Cod	Dimensiune	Pret €	Ambalare
 maneta tip fluture rosie			
162 0112	16 x 2,0 - 1/2"		20/80
162 0114	16 x 2,0 - 3/4"		15/60
162 0116	20 x 2,0 - 3/4"		15/60
162 0118	26 x 3,0 - 3/4"		10/40
162 0120	26 x 3,0 - 1"		10/40
 maneta tip fluture albastra			
162 0111	16 x 2,0 - 1/2"		20/80
162 0113	16 x 2,0 - 3/4"		15/60
162 0115	20 x 2,0 - 3/4"		15/60
162 0117	26 x 3,0 - 3/4"		10/40
162 0119	26 x 3,0 - 1"		10/40



2156R

Robinet M de colt pentru tub multistrat cu maneta tip fluture de culoare rosie și albastra

Cod	Dimensiune	Pret €	Ambalare
 maneta tip fluture rosie			
162 0051	20 x 2,0 - 3/4"		15/60
 maneta tip fluture albastra			
162 0052	20 x 2,0 - 3/4"		15/60



01A ROBINETI CU CAPETE DE COMPRESIUNE/PRESARE

Pentru tub multistrat



2157R



Robinet de colt pentru tub multistrat cu maneta tip fluture de culoare rosie, albastra si piulita

Cod	Dimensiune	Pret €	Ambalare
 maneta tip fluture rosie			
162 0047	20 x 2,0 - 3/4"		10/40
162 0060	20 x 2,0 - 1"		10/40
162 0049	26 x 3,0 - 3/4"		10/40
162 0062	26 x 3,0 - 1"		10/40
 maneta tip fluture albastra			
162 0048	20 x 2,0 - 3/4"		10/40
162 0061	20 x 2,0 - 1"		10/40
162 0050	26 x 3,0 - 3/4"		10/40
162 0063	26 x 3,0 - 1"		10/40



2158

Robinet de colt pentru tub multistrat cu maneta tip fluture si piulita



Cod	Dimensiune	Pret €	Ambalare
 maneta tip fluture rosie			
162 0125	16 x 2,0 - 1/2"		10/60
 maneta tip fluture albastra			
162 0126	16 x 2,0 - 1/2"		10/60

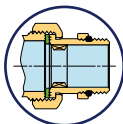

2181CPR

Robinet de colt cu olandez si GARNITURA PLATA



Cod	Dimensiune	Pret €	Ambalare
 maneta tip fluture rosie			
162 0045	20 x 3/4"		10/40
162 0014	26 x 3/4"		10/40
162 0010	26 x 1"		5/20
162 0015	32 x 1"		5/20
 maneta tip fluture albastra			
162 0046	20 x 3/4"		10/40
162 0004	26 x 3/4"		10/40
162 0009	26 x 1"		5/20
162 0013	32 x 1"		5/20



1697

Robinet presare drept cu maneta tip fluture de culoare rosie sigilabila si piulita

Cod	Dimensiune	Pret €	Ambalare
168 0021	20 x 3/4"		20/80
168 0035	25 x 3/4"		20/80
168 0030	26 x 3/4"		20/80
168 0032	32 x 1"		10/40



1697CK

Robinet presare drept cu maneta tip fluture de culoare rosie sigilabila, piulita si supapa de sens



 Directie flux

Cod	Dimensiune	Pret €	Ambalare
168 0029	20 x 3/4"		20/80
168 0027	25 x 3/4"		20/80
168 0036	26 x 3/4"		20/80
168 0037	32 x 1"		10/40



1691

Robinet presare cu sfera cu maneta tip fluture

Cod	Dimensiune	Pret €	Ambalare
168 0010	16 x 16		5/50
168 0065	18 x 18		5/50
168 0007	20 x 20		5/50
168 0025	25 x 25		5/50
168 0008	26 x 26		5/50
168 0087	32 x 32		5/30



LISTA DE PREȚURI

01A ROBINETI CU CAPETE DE COMPRESIUNE/PRESARE

Pentru tub multistrat



1692

Robinet presare de colt cu maneta tip fluture de culoare rosie, albastra si piulita

i Disponibil cu maneta tip fluture albastra

Cod	Dimensiune	Pret €	Ambalare
 maneta tip fluture rosie			
168 0077	16 x 3/4"		10/40
168 0019	20 x 3/4"		10/40
168 0028	25 x 3/4"		10/40
168 0020	26 x 3/4"		10/40
168 0034	32 x 1"		10/40



1692CK

Robinet presare de colt cu maneta tip fluture de culoare rosie, piulita si supapa de sens



i ↗ Directie flux

Cod	Dimensiune	Pret €	Ambalare
168 0026	20 x 3/4"		10/40
168 0018	25 x 3/4"		10/40
168 0031	26 x 3/4"		10/40
168 0022	32 x 1"		10/40



1690

Robinet presare cu sfera de incastrat



i Pentru accesorii vezi pag. 47

Cod	Dimensiune	Pret €	Ambalare
168 0002	16 x 16		5/50
168 0004	18 x 18		5/50
168 0001	20 x 20		5/50
168 0009	25 x 25		5/50
168 0003	26 x 26		5/50



1690U

Robinet presare cu sfera de incastrat "U"



i Pentru accesorii vezi pag. 47

Cod	Dimensiune	Pret €	Ambalare
168 0013	16 x 16		1/25
168 0011	20 x 20		1/25
168 0016	25 x 25		1/25
168 0033	26 x 26		1/25



1696

Robinet presare cu obertein de incastrat 2 cai



i Pentru accesorii vezi pag. 47

Cod	Dimensiune	Pret €	Ambalare
168 0012	16 x 16		5/50
168 0017	18 x 18		5/50
168 0014	20 x 20		5/50
168 0024	25 x 25		5/50
168 0023	26 x 26		5/50

01A ROBINETI CU CAPETE DE COMPRESIUNE

Pentru tub cupru



2142

Robinet cu capete de compresie CUPRU cu maneta rosie, de aluminiu

Cod	Dimensiune	Pret €	Ambalare
214 0004	15		15/60
214 0008	18		15/60
214 0002	22		10/40
214 0005	28		7/28



2152

Robinet cu capete de compresie CUPRU cu maneta rosie, tip fluture

Cod	Dimensiune	Pret €	Ambalare
214 0003	15		15/60
214 0006	18		15/60
214 0001	22		10/40
214 0007	28		7/28





2263
Robinet drept F ISO 228 cu piulita

Cod	Dimensiune	Pret €	Ambalare
226 0002	1/2" x 1/2"		10/60
226 0001	3/4" x 3/4"		10/60
226 0003	1" x 1"		10/40
226 0044	1/2" x 3/4"		20/80
226 0020	1/2" x 3/4"		20/80
226 0021	3/4" x 1"		10/40

Versiunea nichelata

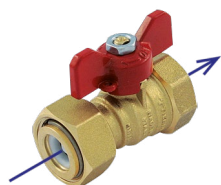

2263CK
Robinet drept F ISO 228 cu piulita si supapa de sens





i ↗ Directie flux

Cod	Dimensiune	Pret €	Ambalare
226 0004	1/2" x 1/2"		20/80
226 0005	3/4" x 3/4"		20/80
226 0006	1" x 1"		10/40
226 0022	1/2" x 3/4"		20/80
226 0023	3/4" x 1"		10/40

Versiunea nichelata





2266
Robinet drept M ISO 228 cu piulita

Cod	Dimensiune	Pret €	Ambalare
 maneta tip fluture rosie			
226 0050	1/2" M ISO7 x 1/2" F		20/80
226 0049	1/2" M ISO7 x 3/4" F		20/80
226 0010	3/4" M - 3/4" F		20/80
226 0012	3/4" M - 1" F		10/40
 maneta tip fluture neagra			
226 0048	1/2" M ISO7 - 1/2" F		20/80
226 0047	1/2" M ISO7 - 3/4" F		20/80
226 0046	3/4" M - 3/4" F		20/80



2281
Robinet drept M ISO 228 cu piulita si maneta tip fluture

Cod	Dimensiune	Pret €	Ambalare
 maneta tip fluture rosie			
226 0140	3/4" M - 3/4" F		10/60
226 0145	1" M - 3/4" F		8/48
 maneta tip fluture albastra			
226 0141	3/4" x 3/4"		10/60
226 0146	1" M - 3/4" F		8/48
 maneta tip fluture neagra			
226 0196	3/4" x 3/4"		10/60

La cerere



2285
Robinet drept F ISO 228 cu piulita si maneta tip fluture

Cod	Dimensiune	Pret €	Ambalare
226 0198	3/4" F - 1" F		8/48
226 0197	1" F - 1" F		8/48

La cerere



2266CK
Robinet drept M ISO 228 cu piulita si supapa de sens



i ↗ Directie flux

Cod	Dimensiune	Pret €	Ambalare
226 0011	3/4" M - 3/4" F		20/80
226 0013	3/4" M - 1" F		10/40



2224N



Robinet de colt M ISO7/EN 10226 cu piulita si maneta tip fluture neagra

Cod	Dimensiune	Pret €	Ambalare
226 0031	1/2" M x 1/2" F		20/80
226 0032	1/2" M x 3/4" F		20/80
226 0030	3/4" M x 3/4" F		10/40
226 0173	1" M x 1" 1/4 F		5/20



2266SP

Robinet drept M ISO 228 cu piulita, drenaj si maneta tip fluture

Cod	Dimensiune	Pret €	Ambalare
 maneta tip fluture rosie			
226 0127	3/4" x 3/4"		15/60
 maneta tip fluture albastra			
226 0128	3/4" x 3/4"		15/60



2228

Robinet de colt M cu piulita si maneta tip fluture

 Disponibil cu maneta tip fluture albastra

Cod	Dimensiune	Pret €	Ambalare
 maneta tip fluture rosie			
226 0153	1/2" x 1/2"		20/80
226 0155	3/4" x 3/4"		15/60
226 0157	3/4" x 1"		15/60
226 0159	1" x 1"		10/40



2229

Robinet de colt F cu piulita si maneta tip fluture

 Disponibil cu maneta tip fluture albastra

Cod	Dimensiune	Pret €	Ambalare
 maneta tip fluture rosie			
226 0161	1/2" x 1/2"		20/80
226 0163	3/4" x 3/4"		15/60
226 0165	3/4" x 1"		15/60
226 0167	1" x 1"		10/40



LISTA DE PRETURI



2320AF
Robinet SCIROCCO F/F ISO 228
cu maneta fluture anti-frauda

i Maneta din alamă

+ Anti-frauda

Cod	Dimensiune	Pret €	Ambalare
231 0274	1/2"		25/75
231 0425	3/4"		15/45
231 0359	1"		10/30
231 0426	1"1/4		4/16

N Noutati



2321AF
Robinet SCIROCCO M/F ISO 228
cu maneta fluture anti-frauda

i Maneta din alamă

+ Anti-frauda

Cod	Dimensiune	Pret €	Ambalare
231 0388	1"1/4		4/16
231 0389	1"1/2		3/12
231 0390	2"		2/8



2370AF
Robinet MISTRAL F/F ISO 228 cu
maneta fluture anti-frauda

i Maneta din alamă

+ Anti-frauda

Cod	Dimensiune	Pret €	Ambalare
236 0227	1/2"		25/100
236 0228	3/4"		15/60
236 0230	1"		10/30



2258AF
Robinet cu sfera filet interior
ISO 228 cu piulita semiolandez
cu filtru si maneta fluture anti-
frauda

i Maneta din alamă

+ Anti-frauda

Cod	Dimensiune	Piuliță semiolandez	Pret €	Ambalare
226 0098	3/4"	3/4"		10/40



2263AF
Robineti cu sfera filet F ISO
228 si piulita libera cu maneta
fluture anti-frauda

i Maneta din alamă

+ Anti-frauda

Cod	Dimensiune	Piuliță semiolandez	Pret €	Ambalare
226 0065	1/2"	3/4"		15/60
226 0066	3/4"	3/4"		15/60
226 0064	3/4"	1"		10/40
226 0063	1"	1"		10/40

L La cerere



22660T
Robinet cu sfera filet masculin
ISO 228 si piulita cu maneta din
alama

i Filet exterior cu fata plana

Cod	Dimensiune	Pret €	Ambalare
226 0028	3/4"		15/60



22660TW
Robinet cu sfera filet masculin
ISO 228 si piulita cu maneta din
alama

i Maneta din alamă

Cod	Dimensiune	Piuliță semiolandez	Pret €	Ambalare
226 0053	1/2"	3/4"		15/60
226 0058	3/4"	3/4"		15/60
226 0052	3/4"	1"		10/40
226 0051	1"	1"		10/40



2284SPCK

Robinet cu sfera pentru contoare, cu filet exterior conform ISO228, piulita semiolandez, cu posibilitate de purjare - Livrat cu supapa de retinere



- i ↗ Direcția fluxului
- i Maneta din alamă
- + Supapă de retinere
- + Blocabil

Cod	Dimensiune	Piuliță semiolandez	Pret €	Ambalare
226 0206	3/4"	3/4"		12/48



2266AF

Robinet cu sfera filet masculin ISO 228 si piulita libera cu maneta fluture anti-frauda

- i Maneta din alamă
- + Anti-frauda

Cod	Dimensiune	Piuliță semiolandez	Pret €	Ambalare
226 0057	1/2"	3/4"		15/60
226 0054	3/4"	3/4"		15/60
226 0056	3/4"	1"		10/40
226 0055	1"	1"		10/40



2266LAF

Robineti cu sfera filet masculin ISO 228 si piulita libera cu maneta fluture anti-frauda

- i Maneta din alamă
- + Anti-frauda

Cod	Dimensiune	Piuliță semiolandez	Pret €	Ambalare
226 0087	3/4"	3/4"		15/60
226 0205	1"	1"		6/18



2267OT

Robinet cu sfera pentru tub PE si piulita cu maneta din alamă

Cod	Tub PE	Piuliță semiolandez	Pret €	Ambalare
226 0075	Ø 25	3/4"		10/40
226 0117	Ø 25	1"		8/32
226 0132	Ø 32	3/4"		8/32
226 0133	Ø 32	1"		7/28
226 0116	Ø 40	1" 1/2		4/16
226 0126	Ø 50	2"		2/8

La cerere



2267AF

Robinet cu sfera pentru tub PE si piulita libera cu maneta fluture anti-frauda

- i Maneta din alamă
- + Anti-frauda

Cod	Tub PE	Piuliță semiolandez	Pret €	Ambalare
226 0080	Ø 25	3/4"		10/40
226 0118	Ø 32	3/4"		8/32
226 0119	Ø 32	1"		7/28
226 0120	Ø 40	1"	85,24	4/16
226 0122	Ø 50	1" 1/2	162,81	2/8
226 0121	Ø 40	1" 1/2		4/16
226 0123	Ø 50	2"		2/8

La cerere



2277

Robinet cu sfera pentru tub PE cu tija de manevra 28 mm

Cod	Tub PE	Pret €	Ambalare
226 0136	Ø 25		8/32



NOUȚĂȚI



2277B

Robinet cu sfera pentru tub PE cu tija de manevra 28 mm (Cu stut de ranforsare)

i Maneta din alamă □ 28 mm

+ Blocabil

Cod	Tub PE	Pret €	Ambalare
226 0220	Ø 63 x 5,8		1/5



2273AF

Robinet drept M ISO 228 si piulita libera cu maneta fluture anti-frauda

i Maneta din aluminiu

+ Anti-frauda

Cod	Dimensiune	Piuliță semiolandez	Pret €	Ambalare
226 0131	1/2"	3/4"		10/40



2272LAF

Robinet coltar cu sfera pentru tub PE anti-frauda

i Maneta din aluminiu

+ Anti-frauda

Cod	Tub PE	Piuliță semiolandez	Pret €	Ambalare
226 0088	Ø 25	3/4"		10/40
226 0124	Ø 32	3/4"		5/20
226 0125	Ø 32	1"		5/20

NOUȚĂȚI



2272LAFSP4

Robinet coltar cu sfera pentru tub PE anti-frauda cu 4 stuturi de drenaj

i Maneta din aluminiu

+ Anti-frauda

Cod	Tub PE	Piuliță semiolandez	Pret €	Ambalare
220 0234	Ø 25	3/4"		6/24



2246

Robinet nichelat tip coltar cu sfera pentru apa cu racord pentru PE/piulita semiolandez si maneta din plastic rosie

i Maneta din plastic

Cod	Tub PE	Piuliță semiolandez	Pret €	Ambalare
226 0105	Ø 20	3/4"		10/40
226 0106	Ø 25	3/4"		10/40



2245

Robinet cu sfera racord PE/filet exterior si maneta din plastic rosie

i Maneta din plastic

Cod	Tub PE	Dimensiune	Pret €	Ambalare
226 0103	Ø 20	1/2"		15/60
226 0104	Ø 25	3/4"		10/60

La cerere



2247CK

Robinet nichelat tip coltar cu sfera pentru apa cu filet exterior/piulita semiolandez, supapa de retinere si maneta din plastic rosie



i ↗ Direcția fluxului

i Maneta din plastic

Cod	Dimensiune	Piuliță semiolandez	Pret €	Ambalare
226 0107	3/4"	3/4"		10/40



2264AF

Robinet cu sfera filet interior ISO228 cu racord semiolandez telescopic (15mm) si maneta anti-frauda

Maneta din alamă

Anti-frauda

Cod	Dimensiune	Piuliță semiolandez	Pret €	Ambalare
226 0070	3/4"	3/4"		10/40
226 0069	1"	1"		10/40

La cerere



2265AF

Robinet cu sfera filet exterior cu racord semiolandez telescopic (15mm), conform ISO228, cu maneta anti-frauda

Maneta din alamă

Anti-frauda

Cod	Dimensiune	Piuliță semiolandez	Pret €	Ambalare
226 0074	3/4"	3/4"		10/40
226 0073	1"	1"		10/40

La cerere

2264AF - 2265AF

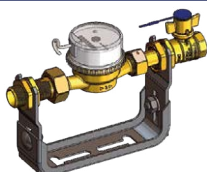

Robinetul trebuie fixat corespunzător pentru a preveni acțiunea forțelor laterale asupra manșonului extensibil



2279AF

Robinet cu sfera filet interior ISO228 cu racord semiolandez telescopic, cu maneta anti-frauda

Maneta din alamă

Anti-frauda

Cod	Dimensiune	Piuliță semiolandez	Pret €	Ambalare
226 0199	1/2"	3/4"		12/48
226 0183	3/4"	3/4"		12/48

La cerere



2283AF

Robinet cu sfera filet exterior ISO228 cu racord semiolandez telescopic, cu maneta anti-frauda

Maneta din alamă

Anti-frauda

Cod	Dimensiune	Piuliță semiolandez	Pret €	Ambalare
226 0210	1/2"	3/4"		12/48
226 0185	3/4"	3/4"		12/48



LISTA DE PREȚURI



2266AFCH
Cheie pentru maneta anti-fraudă

BREVETAT

Cod	Lungimea	Pret €	Ambalare
296 0085	60 mm		1/40
296 0148	180 mm		1/20

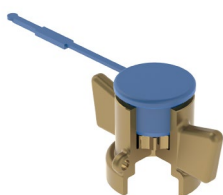

2263SET
Kit maneta fluture anti-frauda

BREVETAT

Cod	Dimensiune	Pret €	Ambalare
226 0083	-		1/25



2266AFCO
Kit colier anti-frauda pentru piulita

BREVETAT

Cod	Dimensiune	Pret €	Ambalare
296 0117	3/4"		1/40
296 0188	1"		1/30
296 0187	1"1/4		1/25
296 0189	1"1/2		1/20
296 0190	2"		1/20



H9602
Piulita pentru maneta fluture anti-frauda

Cod	Dimensiune	Pret €	Ambalare
040 0268	M7 x 1		10/1500
040 0269	M9 x 1,25		10/1500



H9604
Surub pentru colier anti-frauda (Art. 2266AFCO)

Cod	Dimensiune	Pret €	Ambalare
040 0270	M8 x 10		10/1000

La cerere

FLUXUL DE APĂ ESTE DESCHIS

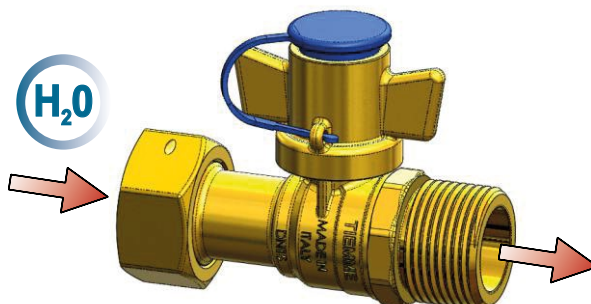

INSTRUCȚIUNI PENTRU MANETA ANTI-FRAUDĂ

1 Oprți fluxul de apă

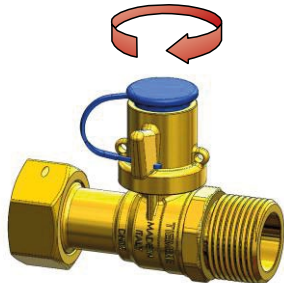

2 Îndepărtați capacul

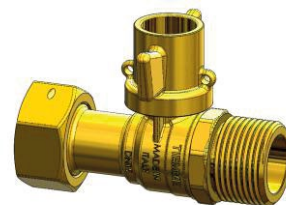

3 Introduceți cheia specială pentru a prinde piulița și a atinge pârghia cu inelul exterior al cheii

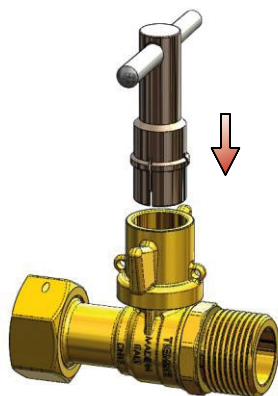

4 Deșurubați

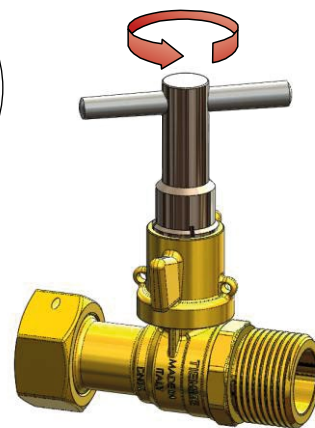
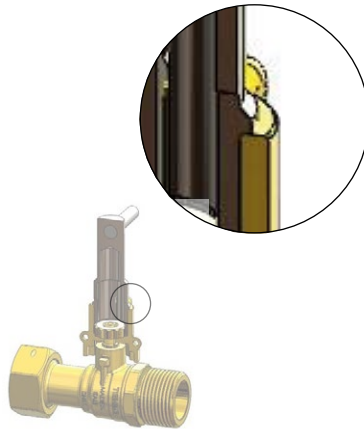

5 Extrageți piulița și maneta în formă de «T»

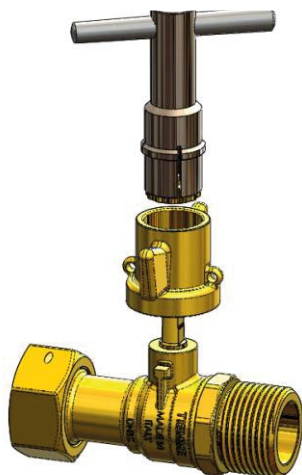

6 Introduceți maneta în formă de «T» în poziția de închidere



7 Introduceți cheia specială și fixați piulița

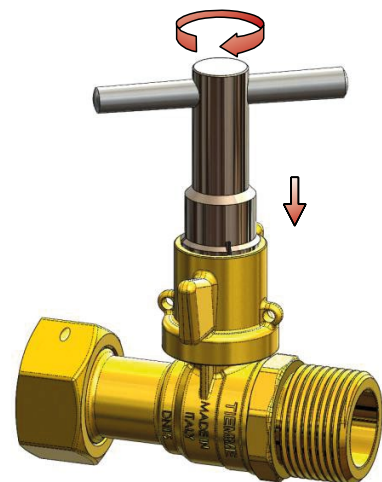

**2270**

Robinet URAGANO F/F ISO 7/EN 10226 cu tija de manevra 28 mm

Maneta din alamă de □ 28 mm

Sigilabil

Cod	Dimensiune	Pret €	Ambalare
220 0204	1/2"		15/60
220 0166	3/4"		10/40
220 0167	1"		8/32
220 0168	1" 1/4		4/16
220 0169	1" 1/2		3/12
220 0170	2"		2/8

**2271**

Robinet URAGANO M/F ISO 7/EN 10226 cu tija de manevra 28 mm

Maneta din alamă de □ 28 mm

Sigilabil

Cod	Dimensiune	Pret €	Ambalare
220 0205	1/2"		15/60
220 0177	3/4"		10/40
220 0178	1"		8/32
220 0179	1" 1/4		4/16
220 0180	1" 1/2		3/12
220 0181	2"		2/8

**2340**

Robinet SCIROCCO F/F ISO 228 cu tija de manevra 28 mm

Maneta din alamă de □ 28 mm

Sigilabil

Cod	Dimensiune	Pret €	Ambalare
231 0275	1/2"		15/60

**2266QU**

Robinet cu sfera "URAGANO" cu file exterior/piulita semiolandez cu tija de manevra 28mm

Maneta din alamă de □ 28 mm

Sigilabil

Cod	Dimensiune	Piuliță semiolandez	Pret €	Ambalare
226 0100	2"	2"		2/8

2266QU

CARACTERISTICI TEHNICE

Piuliță semiolandez

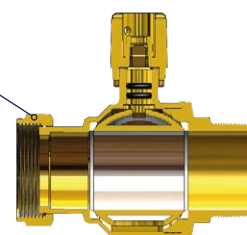
**2271Q32**

Robinet cu sfera "URAGANO" cu file exterior/interior conform ISO7/EN 10226 cu tija de manevra 32mm

Maneta din alamă de □ 32 mm

Cod	Dimensiune	Pret €	Ambalare
220 0165	1" 1/4		3/12

**2266LP**

Robinet cu sfera "URAGANO" cu file exterior/piulita semiolandez cu maneta plata rosie plastificata

Maneta de otel

Cod	Dimensiune	Piuliță semiolandez	Pret €	Ambalare
226 0099	2"	2"		2/8

2266LP

CARACTERISTICI TEHNICE

Piuliță semiolandez

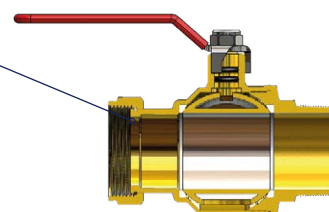



2510
Robinet portfurtun cu maneta de aluminiu de culoare rosie și neagră

Cod	Dimensiune	Pret €	Ambalare
maneta tip levier rosie			
250 0012	3/8"		12/48
250 0001	1/2"		12/48
250 0003	3/4"		7/28
250 0004	1"		4/16
maneta tip levier neagră			
250 0042	3/8"		12/48
250 0043	1/2"		12/48
250 0044	3/4"		7/28
250 0045	1"		4/16



2520
Robinet portfurtun cu maneta tip fluture de culoare rosie

i Disponibil cu maneta tip fluture albastra

Cod	Dimensiune	Pret €	Ambalare
250 0007	1/2"		12/48



2584
Robinet cu sfera cu maneta sigilabila

Cod	Dimensiune	Pret €	Ambalare
250 0009	1/2"		12/48



2530X316
Robinet cu sfera cu portfurtun și maneta din inox AISI 316 gri plata

+ MANETA AISI 316

Cod	Dimensiune	Pret €	Ambalare
250 0061	1/2"		10/40



2511B
Robinet EOLO NO FROST portfurtun cu maneta de aluminiu de culoare albastra

+ NO FROST

Cod	Dimensiune	Pret €	Ambalare
250 0075	1/2"		25/50
250 0076	3/4"		20/40



2512B
Robinet EOLO NO FROST portfurtun cu maneta de aluminiu de culoare albastra

+ NO FROST

Cod	Dimensiune	Pret €	Ambalare
250 0102	1/2"		25/50
250 0104	3/4"		20/40



2535V
Robinet EOLO DUPLEX NO FROST portfurtun cu maneta verde plata

+ NO FROST

Cod	Dimensiune	Pret €	Ambalare
250 0062	1/2"		5/20





2585G
Robinet portfurtun serie
"masiva"

Cod	Dimensiune	Pret €	Ambalare
258 0001	1/2"		1/25
258 0003	3/4"		1/20
258 0007	1"		4/16



2588C
Robinet cromat serie "masiva"

Cod	Dimensiune	Pret €	Ambalare
258 0043	1/2"		1/25
258 0049	3/4"		1/20

01A MINIROBINETI CU SFERA CROMATA "SMALL"



2900
Mini-robinet F/F cu maneta de culoare neagră

Cod	Dimensiune	Pret €	Ambalare
290 0022	1/4"		30/180
290 0016	3/8"		25/150
290 0006	1/2"		20/120



2901
Mini-robinet M/F cu maneta de culoare neagră

Cod	Dimensiune	Pret €	Ambalare
290 0011	1/4"		30/180
290 0004	3/8"		25/150
290 0001	1/2"		20/120



2902
Mini-robinet M/M cu maneta de culoare neagră

Cod	Dimensiune	Pret €	Ambalare
290 0045	1/4"		30/180
290 0031	3/8"		25/150
290 0008	1/2"		20/120



2940
Mini-robinet CU/F cu maneta de culoare neagră

Cod	Dimensiune	Pret €	Ambalare
290 0033	10 x 1/2"		20/120
290 0034	12 x 1/2"		20/120
290 0030	15 x 1/2"		15/90
290 0041	16 x 1/2"		15/90



2942
Mini-robinet CU/CU cu maneta de culoare neagră

Cod	Dimensiune	Pret €	Ambalare
290 0012	10 x 10		20/120
290 0005	12 x 12		20/120
290 0059	14 x 14		20/120
290 0007	15 x 15		15/90
290 0119	15 x 16		15/90
290 0060	16 x 16		15/90

Noutati



2931
Mini-robinet cu sfera SMALL M/F cu fanta pentru surubelnita

Cod	Dimensiune	Pret €	Ambalare
290 0019	3/8"		25/150



2932
Mini-robinet cu sfera SMALL M/M cu fanta pentru surubelnita



Cod	Dimensiune	Pret €	Ambalare
290 0056	3/8"		40/240
290 0054	1/2"		25/150





2944



Mini-robinet cu sfera pentru tub multistrat cu maneta aluminiu de culoare rosie sau albastra

Cod	Dimensiune	Pret €	Ambalare
 maneta tip fluture rosie			
294 0029	16 x 2,0 - 1/2"		25/100
 maneta tip fluture albastra			
294 0028	16 x 2,0 - 1/2"		25/100



2945



Mini-robinet cu sfera pentru tub de cupru cu maneta aluminiu de culoare rosie sau albastra

Cod	Dimensiune	Pret €	Ambalare
 maneta tip fluture rosie			
294 0020	15 - 1/2"		25/100
294 0018	16 - 1/2"		25/100
294 0035	18 - 1/2"		25/100
 maneta tip fluture albastra			
294 0019	15 - 1/2"		25/100
294 0016	16 - 1/2"		25/100
294 0034	18 - 1/2"		25/100



2947

Mini-robinet cu sfera pentru tub Pex cu maneta aluminiu de culoare rosie sau albastra

Cod	Dimensiune	Pret €	Ambalare
 maneta tip fluture rosie			
294 0002	16 x 2,0 - 1/2"		25/100
 maneta tip fluture albastra			
294 0001	16 x 2,0 - 1/2"		25/100



2941

Mini-robinet cu sfera filet M si piulita semiolandez, cu maneta din aluminiu rosie pentru colectoare



Fata dreapta (plana)

Cod	Dimensiune	Pret €	Ambalare
294 0054	1/2" x 1/2"		25/100



2946GR

Mini-robinet M/F pentru colectoare cu maneta din plastic rosie sau albastra

Cod	Dimensiune	Pret €	Ambalare
 maneta tip fluture rosie			
294 0010	1/2" - 1/2"		25/100
 maneta tip fluture albastra			
294 0009	1/2" - 1/2"		25/100



2139

Robinet cu sfera motorizat, cu trecere totala, cu 2 cai F/F, pentru actuator cu baza ISO5211

Cod	Dimensiune	Pret €	Ambalare
213 0104	1/2"		15/60
213 0107	3/4"		10/40
213 0108	1"		7/28



2138

Robinet cu sfera, motorizat cu 2 iesiri M/F



i Disponibil si cu alimentare 24 Vac

Cod	Dimensiune	Aliment.	Pret €	Ambalare
213 0020	1/2"	230 Vac		1/14
213 0003	3/4"	230 Vac		1/14
213 0007	1"	230 Vac		1/14
213 0019	1"1/4	230 Vac		1/14



2133

Robinet cu sfera, motorizat cu 2 iesiri M/M



i Disponibil si cu alimentare 24 Vac

Cod	Dimensiune	Aliment.	Pret €	Ambalare
213 0011	3/4"	230 Vac		1/14
213 0016	1"	230 Vac		1/14



9535

Servomotor pentru robinet cu 2 cai (art. 2138-2133); rotatie monodirectionala cu unghi de 90° dotat cu siguranta de protectie. Carcasa cu grad de protectie IP54

Cod	Tensiune	Timp manevra	Pret €	Ambalare
213 0024	230 Vac	30 sec		1/8
213 0072	24 Vac	30 sec		1/8



2134

Robinet cu sfera, motorizat cu 3 cai deviator, cu 3 intrari

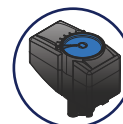

i Disponibil si cu alimentare 24 Vac

Cod	Dimensiune	Aliment.	Pret €	Ambalare
213 0009	3/4"	230 Vac		1/4
213 0018	1"	230 Vac		1/4

Până la terminarea stocului



9537

Servomotor pentru robinet deviator (art.2134); rotatie monodirectionala cu unghi de 180° dotat cu siguranta de protectie. Carcasa cu grad de protectie IP54

Cod	Tensiune	Timp manevra	Pret €	Ambalare
213 0025	230 Vac	60 sec		1/8
213 0031	24 Vac	60 sec		1/8

Până la terminarea stocului



NOU TATI



2135

Robinet cu sfera, motorizat cu 3 cai deviator, cu 3 intrari

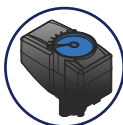

i Disponibil si cu alimentare 24 Vac

i Ideal pentru pompe de cãldurã

Cod	Dimensiune	Aliment.	Pret €	Ambalare
213 0166	3/4"	230 Vac		1/4
213 0167	1"	230 Vac		1/4
213 0168	1"-1"1/4	230 Vac		1/4

NOU TATI



2135ISOL

Izolatie pentru robinet de zona cu by-pass (art. 2136) si pentru robinet deviator (art. 2135)

Cod	Dimensiune	Pret €	Ambalare
556 0466	3/4"		1/5
556 0467	1"-1"1/4		1/5



2137

Robinet cu sfera, motorizat cu 3 cai cu by-pass, cu 3 intrari



i Disponibil si cu alimentare 24 Vac

Cod	Dimensiune	Aliment.	Pret €	Ambalare
213 0021	3/4"	230 Vac		1/4
213 0015	1"	230 Vac		1/4



2136

Robinet cu sfera, motorizat cu 3 cai cu by-pass, cu 4 intrari, distanta variabila intre axe (50-63 mm pentru robinet de 3/4" - 55-63 mm pentru robinet de 1")



i Disponibil si cu alimentare 24 Vac

Cod	Dimensiune	Aliment.	Pret €	Ambalare
213 0013	3/4"	230 Vac		1/4
213 0028	1"	230 Vac		1/4



9536

Servomotor pentru robinet de zona cu by-pass (art. 2136-2137) si pentru robinet deviator (art. 2135); rotatie bidirectionala cu unghi de 90° dotat cu siguranta de protectie. Carcasa cu grad de protectie IP54

Cod	Tensiune	Timp manevra	Pret €	Ambalare
213 0030	230 Vac	30 sec		1/8
213 0037	24 Vac	30 sec		1/8

2138 - 2133

CARACTERISTICI TEHNICE

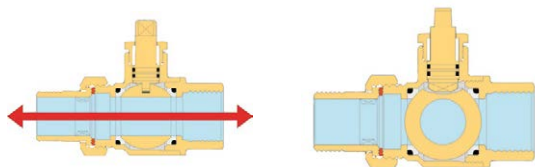

- Alimentare 230 Vac sau 24 Vac
- Contact releu 6A 250 Vac
- Grad de protectie IP 54
- Cuplu maxim de rotatie 10 Nm
- Timp rotație 30 sec.
- Siguranta 5x20 F350 mA

2135

CARACTERISTICI TEHNICE

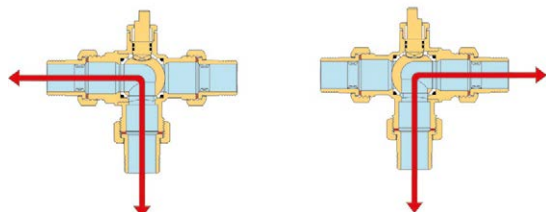

- Alimentare 230 Vac sau 24 Vac
- Contact releu 6A 250 Vac
- Grad de protectie IP 54
- Cuplu maxim de rotatie 10 Nm
- Timp rotație 30 sec.
- Siguranta 5x20 F350 mA.

2137

CARACTERISTICI TEHNICE

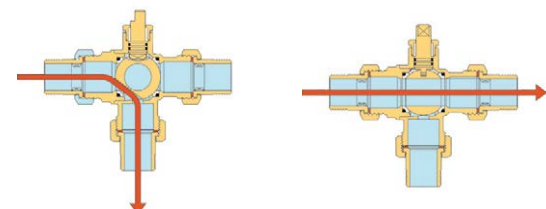

- Alimentare 230 Vac sau 24 Vac
- Contact releu 6A 250 Vac
- Grad de protectie IP 54
- Cuplu maxim de rotatie 10 Nm
- Timp rotație 30 sec.
- Siguranta 5x20 F350 mA

2136

CARACTERISTICI TEHNICE

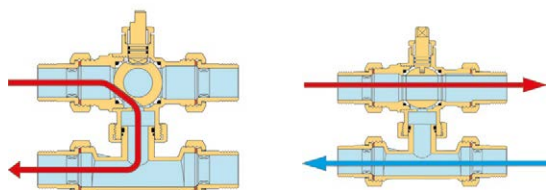

- Alimentare 230 Vac sau 24 Vac
- Contact releu 6A 250 Vac
- Grad de protectie IP 54
- Cuplu maxim de rotatie 10 Nm
- Timp rotație 30 sec.
- Siguranta 5x20 F350 mA



LISTA DE PREȚURI



2959
Robinet special sublavoar cu filtru si rozeta decorativa

Cod	Dimensiune	Pret €	Ambalare
295 0049	1/2" x 3/8"		15/60
295 0055	1/2" x 1/2"		15/60



2956
Robinet special sublavoar cu filtru si rozeta decorativa

Cod	Dimensiune	Pret €	Ambalare
295 0004	1/2" x 3/8"		15/60
295 0012	1/2" x 1/2"		15/60



2955
Robinet special sublavoar orientabil cu filtru si rozeta decorativa

Cod	Dimensiune	Pret €	Ambalare
295 0224	1/2" x 10		15/60



2948
Robinet special sublavoar orientabil 1/2"x(1/2", 3/8", Ø10) si rozeta decorativa

Cod	Dimensiune	Pret €	Ambalare
295 0007	1/2" x 10		15/60

2959 - 2956
2955 - 2948

DIMENSIUNI

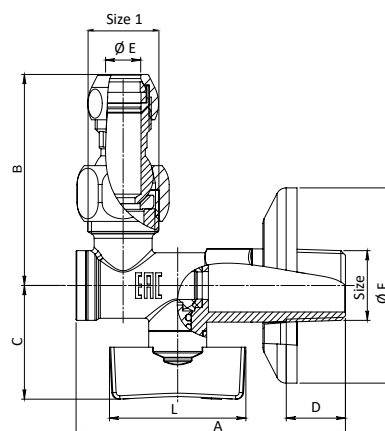

Cod	Size	Size 1 Ø	A	B	C	D	Ø E	Ø F	L
295 0049	R 1/2"	G 3/8"	72	22	32,5	16	-	56	31,5
295 0055	R 1/2"	G 1/2"	72	22	32,5	16	-	56	31,5
295 0004	R 1/2"	G 3/8"	79	22	32,5	17,5	-	56	40
295 0012	R 1/2"	G 1/2"	79	22	32,5	17,5	-	56	40
295 0224	R 1/2"	G 1/2"	70	60	32	15	10	56	31,5
295 0007	R 1/2"	G 1/2"	79	60	32,5	17,5	10	56	40



3906C

Robinet sublavoar cu obertein si rozeta decorativa

Cod	Dimensiune	Pret €	Ambalare
295 0132	1/2" x 3/8"		1/60
295 0130	1/2" x 1/2"		1/60



3907C

Robinet sublavoar cu obertein si rozeta decorativa

Cod	Dimensiune	Pret €	Ambalare
295 0133	1/2" x 10		1/60



3901C

Robinet sublavoar cu obertein si rozeta decorativa

Cod	Dimensiune	Pret €	Ambalare
295 0013	1/2" x 3/8"		10/50
295 0008	1/2" x 1/2"		10/50



3900C

Robinet sublavoar cu obertein si rozeta decorativa

Cod	Dimensiune	Pret €	Ambalare
295 0016	1/2" x 10		10/50



3903C

Robinet sublavoar inclinat M cu filtru si rozeta decorativa

Cod	Dimensiune	Pret €	Ambalare
295 0076	1/2" x 3/8"		1/50



3902C

Robinet sublavoar inclinat M/ tub de cupru cu filtru, orientabil si rozeta decorativa

Cod	Dimensiune	Pret €	Ambalare
295 0038	1/2" x 10		1/50

3901C - 3906C DIMENSIUNI

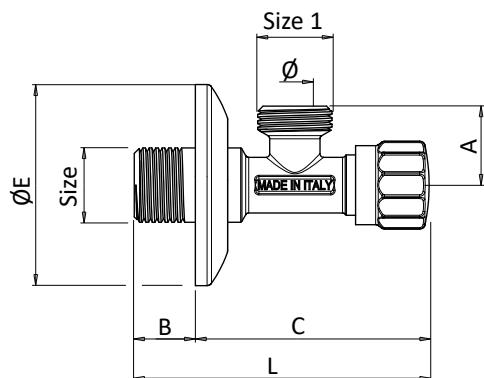

Cod	Size	Size 1	Ø (DN)	A	B	C	Ø E	L
295 0013	1/2"	3/8"	10	23	14	76	56	90
295 0008	1/2"	1/2"	10	23	14	76	56	90
295 0132	1/2"	3/8"	10	22	14	68	56	82
295 0130	1/2"	1/2"	10	22	14	68	56	82





3908C

Robinet pentru masina de spalat cu obtein si rozeta decorativa

Cod	Dimensiune	Pret €	Ambalare
295 0165	1/2" x 3/4"		1/75



3997

Robinet sublavoar cu obtein

Cod	Dimensiune	Pret €	Ambalare
295 0042	1/2" x 1/2"		20/60



2950

Robinet WASH pentru masina de spalat M/M ISO228 cu maneta cromata

Cod	Dimensiune	Pret €	Ambalare
295 0018	1/2" x 1/2"		25/100
295 0011	1/2" x 3/4"		10/50



2953

Robinet WASH pentru masina de spalat M/M ISO 228 cu rozeta decorativa

Cod	Dimensiune	Pret €	Ambalare
295 0010	1/2" x 1/2"		15/60
295 0003	1/2" x 3/4"		10/50



2954

Robinet de colt M/M ISO228 cu maneta cromata si rozeta decorativa

Cod	Dimensiune	Pret €	Ambalare
295 0002	1/2" x 1/2"		1/50
295 0019	1/2" x 3/4"		1/50

2954

DIMENSIUNI

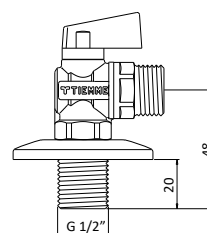

3916C

Robinet coltar mixt cu supapa sens incorporata, combina un robinet ventil coltar si un robinet pentru masina de spalat

Cod	Dimensiune	Pret €	Ambalare
295 0197	1/2" x 3/4" x 3/8"		1/12

3916C

FUNCTIONARE

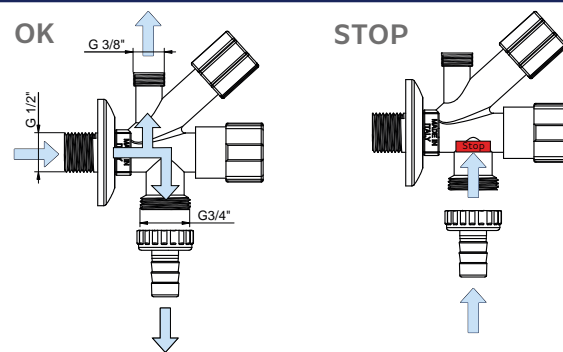



3909C
Robinet sublavoar dublu si rozeta decorativa. Ventil ceramic

Cod	Dimensiune	Pret €	Ambalare
295 0178	1/2" x (1/2" - 3/8")		1/20
295 0196	1/2" x (1/2" - 1/2")		1/20



3925C
Robinet sublavoar si rozeta decorativa. Ventil ceramic

Cod	Dimensiune	Finisare	Pret €	Ambalare
295 0241	1/2"	CROMO		1/25
295 0245	1/2"	RAL 9004		1/25



3910
Racord cromat drept, M pentru legaturi hidro-sanitare

Cod	Dimensiune	Pret €	Ambalare
295 0059	3/8" x 10		10/300
295 0033	1/2" x 10		10/250



3912
Racord drept F pentru legaturi hidro-sanitare

Cod	Dimensiune	Pret €	Ambalare
295 0062	3/8" x 10		10/350
295 0050	1/2" x 10		10/300



3911
Racord drept dublu pentru legaturi hidro-sanitare

Cod	Dimensiune	Pret €	Ambalare
295 0039	10 x 10		10/300



3905C
Cot dus cu rozeta decorativa M/M

Cod	Dimensiune	Pret €	Ambalare
295 0027	1/2"		20/60



2966
Cot sublavoar 90°

Cod	Dimensiune	Pret €	Ambalare
295 0066	1/2" x 3/8"		10/40





2960

Robinet pentru montaj ingropat, fara maneta, model INWALL

Cod	Dimensiune	Pret €	Ambalare
295 0005	1/2"		15/60
295 0020	3/4"		10/40

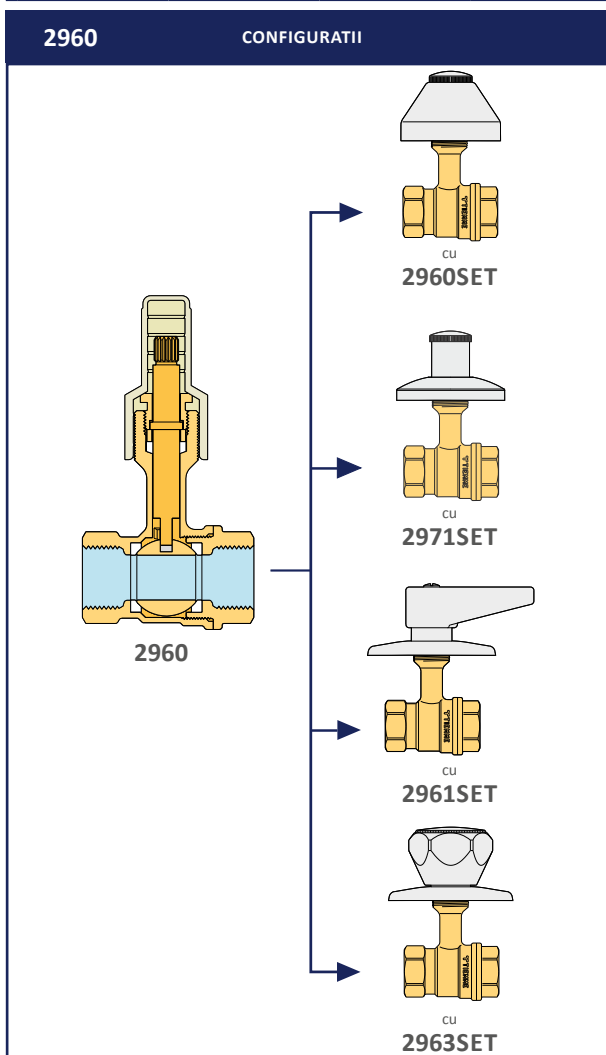

2960SET

Set format din capac si rozeta pentru robinetii de incastat art. 2960, 1690, 1690U, 1696, 1740, 1740U si 1746

Cod	Dimensiune	Pret €	Ambalare
295 0006	-		1/25



2971SET

Set format din capac si rozeta pentru robinetii de incastat Art. 2960, 1690, 1690U, 1696, 1740, 1740U si 1746

Cod	Dimensiune	Pret €	Ambalare
295 0167	-		1/25



2961SET

Set maneta si rozeta decorativa pentru robinetii de incastat art. 2960, 1690, 1690U, 1696, 1740, 1740U si 1746

Cod	Dimensiune	Pret €	Ambalare
295 0009	-		1/25



2963SET

Set maneta si rozeta decorativa pentru robinetii de incastat art. 2960, 1690, 1690U, 1696, 1740, 1740U si 1746.

Cod	Dimensiune	Pret €	Ambalare
295 0014	-		1/25



2960PR

Set de prelungire pentru robinetii de incastat Art. 2960, 1690, 1690U, 1696, 1740, 1740U si 1746

Cod	Dimensiune	Pret €	Ambalare
295 0015	-		1/100



2964

Robinet de incastat PN10 F/F cu rozeta reglabila si maneta

Cod	Dimensiune	Pret €	Ambalare
295 0079	1/2"		5/20
295 0142	3/4"		5/20



2964Z

Robinet de incastat PN10 F/F cu rozeta reglabila si maneta metalica

Cod	Dimensiune	Pret €	Ambalare
295 0134	1/2"		5/20
295 0135	3/4"		5/20
295 0136	1"		5/20

La cerere



2965

Robinet cu obertein de incastat

Cod	Dimensiune	Pret €	Ambalare
295 0026	1/2"		10/30



2965PROL

Set de prelungire pentru robineti art. 2965

Cod	Dimensiune	Pret €	Ambalare
295 0067	-		1/100



2961

INWALL robinet cu sfera pentru instalatii ingropate din cupru prin lipire

Cod	Dimensiune	Pret €	Ambalare
295 0077	15		10/40
295 0074	18		5/20
295 0078	22		5/20

Până la terminarea stocului



2967

Robinet PN 10 F/F cu obertein

Cod	Dimensiune	Pret €	Ambalare
295 0080	1/2"		20/80
295 0081	3/4"		15/60



2970

Robinet pentru hidrant de gradina

Cod	Dimensiune	Pret €	Ambalare
295 0021	1/2"		12/36
295 0028	3/4"		10/30
295 0043	1"		5/15



3994

Robinet cu sertar PN16

Cod	Dimensiune	Pret €	Ambalare
295 0061	1/2"		20/80
295 0041	3/4"		10/40
295 0048	1"		10/40
295 0047	1"1/4		5/20
295 0095	1"1/2		3/12
295 0045	2"		2/6
295 0069	2"1/2		1/5
295 0060	3"		1/5
295 0064	4"		1/2



LISTA DE PRETURI



3996L
Robinet cu 3 cai

Cod	Dimensiune	Pret €	Ambalare
295 0068	3/8"		6/30
295 0025	1/2"		5/25
295 0031	3/4"		4/20
295 0030	1"		4/16
295 0051	1"1/4		1/5
295 0057	1"1/2		1/5
295 0052	2"		1/5



3996T
Robinet cu 3 cai si cu sfera T

Cod	Dimensiune	Pret €	Ambalare
295 0063	3/8"		6/30
295 0058	1/2"		5/25
295 0053	3/4"		4/20
295 0056	1"		4/16
295 0065	1"1/4		1/5
295 0071	1"1/2		1/5
295 0072	2"		1/5



2990G
Robinet cu sfera pentru golire



Cod	Dimensiune	Pret €	Ambalare
295 0024	3/8"		25/100
295 0001	1/2"		25/100
295 0040	1/2"		10/50

Versiune cu lant metalic



3992
Robinet flotor din alama stantata cu tija din plastic

Cod	Dimensiune	Pret €	Ambalare
295 0179	1/2"		1/55
295 0188	3/4"		1/55



3992OT
Robinet flotor din alama stantata cu tija din alama

Cod	Dimensiune	Pret €	Ambalare
295 0189	1/2"		1/55
295 0180	3/4"		1/55
295 0181	1"		1/27



3992PAL
Sfera din plastic pentru robineti cu flotor

Cod	Dimensiune	Pret €	Ambalare
295 0182	Ø 120		1/55
295 0184	Ø 150		1/27



1835C
Robinet flotor

Cod	Dimensiune	Pret €	Ambalare
075 0049	3/4"		1/50
075 0050	1"		1/50
075 0051	1"1/4		1/10
075 0052	1"1/2		1/10
075 0053	2"		1/5
075 0054	2"1/2		1/4
075 0055	3"		1/4
075 0056	4"		1/2

01A ROBINETI CU SFERA PENTRU APLICATII SPECIALE



1836P

Sfera plutitor din polietilenă PEHD de înaltă densitate cu racord culisant și opritor cu șurub

Cod	∅	Pret €	Ambalare
075 0057	120		1/200
075 0058	150		1/100
075 0059	180		1/50
075 0060	220		1/30
075 0061	300		1/10



1837R

Sfera plutitor din cupru, cu racord culisant și opritor cu șurub

Cod	∅	Pret €	Ambalare
075 0062	120		1/1
075 0063	150		1/1
075 0064	180		1/1

01A SUPAPE DE SENS



3500

Supapa de sens YACHT F/F ISO228 cu obturator in nylon



Cod	Dimensiune	Pret €	Ambalare
350 0133	3/8"		20/80
350 0003	1/2"		20/80
350 0004	3/4"		12/48
350 0001	1"		8/32
350 0006	1"1/4		6/24
350 0008	1"1/2		4/16
350 0007	2"		2/8
350 0022	2"1/2		1/6
350 0018	3"		1/4
350 0034	4"		1/2

Noutati



3506

Supapa de sens EUROSTOP F/F ISO228 cu obturator metalic



Cod	Dimensiune	Pret €	Ambalare
350 0531	3/8"		15/60
350 0142	1/2"		15/60
350 0143	3/4"		10/40
350 0144	1"		6/24
350 0145	1"1/4		5/20
350 0146	1"1/2		2/8
350 0147	2"		2/8
350 0050	2"1/2 (L=93 mm)		1/6
350 0515	2"1/2 (L=122 mm)		1/6
350 0051	3" (L=103 mm)		1/4
350 0516	3" (L=141 mm)		1/4
350 0058	4" (L=116 mm)		1/2
350 0517	4" (L=158 mm)		1/2

Noutati





3600

Supapa de sens YACHT F ISO228
cu filtru inox



Cod	Dimensiune	Pret €	Ambalare
350 0352	3/8"		8/80
350 0053	1/2"		8/80
350 0037	3/4"		8/48
350 0012	1"		7/63
350 0027	1"1/4		6/24
350 0039	1"1/2		3/15
350 0040	2"		2/18
350 0057	2"1/2		1/6
350 0059	3"		1/3
350 0065	4"		1/2

Noutati



3606

Supapa de sens EUROSTOP F
ISO228 cu filtru inox



Cod	Dimensiune	Pret €	Ambalare
350 0533	3/8"		16/64
350 0348	1/2"		16/64
350 0349	3/4"		12/48
350 0350	1"		9/36
350 0351	1"1/4		4/16
350 0352	1"1/2		3/12
350 0353	2"		2/8
350 0354	2"1/2 (L=178 mm)		1/5
350 0518	2"1/2 (L=206 mm)		1/5
350 0355	3" (L=202 mm)		1/3
350 0519	3" (L=240 mm)		1/3
350 0356	4" (L=213 mm)		1/2
350 0520	4" (L=276 mm)		1/2

Noutati



3510

Filtru inox pentru supapa de
sens YACHT

Cod	Dimensiune	Pret €	Ambalare
350 0535	3/8"		1/100
350 0054	1/2"		1/100
350 0044	3/4"		1/50
350 0029	1"		1/25
350 0038	1"1/4		1/20
350 0056	1"1/2		1/10
350 0052	2"		1/5
350 0064	2"1/2		1/4
350 0063	3"		1/3
350 0046	4"		1/2



3681

Supapa de sens controlabila,
anti-poluare model EA

 Controlabil (tip EA)

Cod	Dimensiune	Pret €	Ambalare
350 0346	3/4"		10/50
350 0347	1"		10/50



3660

Supapa de sens cu clapet FULL F/F ISO228 cu obturator din alama CU GARNITURA



Cod	Dimensiune	Pret €	Ambalare
350 0015	1/2"		25/75
350 0016	3/4"		15/45
350 0009	1"		10/30
350 0017	1"1/4		5/20
350 0020	1"1/2		5/15
350 0011	2"		2/12
350 0028	2"1/2		1/5
350 0026	3"		1/3
350 0042	4"		1/2



3665

Supapa de sens cu clapet FULL F/F ISO228 cu obturator din alama FARA GARNITURA



Cod	Dimensiune	Pret €	Ambalare
350 0135	1/2"		25/75
350 0136	3/4"		15/45
350 0137	1"		10/30
350 0138	1"1/4		5/25
350 0139	1"1/2		5/15
350 0140	2"		2/12
350 0343	2"1/2		1/5
350 0344	3"		1/3
350 0345	4"		1/2

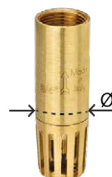

3651

Sorb alama tubular F ISO228

Cod	Dimensiune	Ø	Pret €	Ambalare
350 0047	3/4"	30		5/25
350 0024	1"	36		4/20
350 0043	1"1/4	46		3/15
350 0049	1"1/2	51		4/12
350 0055	2"	64		2/6
350 0062	2"1/2	86		1/5
350 0061	3"	97		1/3
350 0060	4"	123		1/1



3650

Sorb complet alama GLOB F ISO228

Cod	Dimensiune	Pret €	Ambalare
350 0175	1/2"		12/48
350 0033	3/4"		12/36
350 0010	1"		10/30
350 0014	1"1/4		6/18
350 0036	1"1/2		5/15
350 0032	2"		3/9
350 0048	2"1/2		1/6
350 0041	3"		1/3
350 0045	4"		1/5





3670
Filtru Y de impuritati

CARACTERISTICI TEHNICE:

- Grad de filtrare: de la 350 µm la 600 µm in functie de diametru
- Corpul: alama CW 617N
- Presiune maxima de exercitiu: 20 bar pana la 2"; 16 bar celelalte
- Temperatura maxima de exercitiu: 100°C
- Filete: F/F ISO 228

Cod	Dimensiune	Pret €	Ambalare
367 0003	1/2"		20/80
367 0001	3/4"		18/54
367 0002	1"		10/30
367 0005	1"1/4		4/16
367 0009	1"1/2		3/12
367 0004	2"		2/8
367 0011	2"1/2		1/8
367 0014	3"		1/5
367 0015	4"		1/1

Orificiu pentru sigiliu



2094

Set de prelungire pentru robineti montati pe conducte izolate

Cod	URAGANO	SCIROCCO	MISTRAL	TORNADO	Art. 2121	Pret €	Ambalare
209 0001	1/4" - 3/8" - 1/2"	1/4" - 3/8" - 1/2" - 3/4"	1/2" - 3/4"	1/2" - 3/4"	1/2" - 3/4"		40/120
209 0003	3/4"-1"	1"	1" - 1"1/4	1" - 1"1/4	1" - 1"1/4		30/90
209 0002	1"1/4 - 1"1/2 - 2"	1"1/4 - 1"1/2 - 2"	1"1/2 - 2"	1"1/2 - 2"	1"1/2		20/60
209 0006	2"1/2 - 3" - 4"	2"1/2 - 3"-4"	-	-	-		5/15



2595

Portfurtun stut pentru robinet serie EOLO

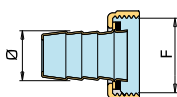

Cod	F	EOLO	Ø	Pret €	Ambalare
250 0010	3/4"	3/8" - 1/2"	14		50/300
250 0014	1"	3/4"	20		25/150
250 0016	1"1/4	1"	25		10/80



2596

Conector furtun prindere rapida cu garnitura pentru robineti EOLO

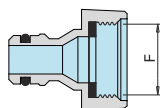

Cod	F	EOLO	Pret €	Ambalare
250 0109	3/4"	1/2"		50/300
250 0110	1"	3/4"		25/150



2962

Rozeta metalica

Cod	Dimensiune	Pret €	Ambalare
209 0005	1/2"		30/360



01_B ROBINETI CU SFERA "TORNADO" PENTRU GAZ

MOP 5



2370G07

Robinet F/F ISO 7/EN10226 cu maneta tip fluture de culoare galbena

Cod	Dimensiune	Pret €	Ambalare
239 0008	1/2"		25/100
239 0009	3/4"		15/60
239 0010	1"		8/32
239 0016	1"1/4		5/20



2371G07

Robinet M/F ISO 7/EN10226 cu maneta tip fluture de culoare galbena

Cod	Dimensiune	Pret €	Ambalare
239 0003	1/2"		25/100
239 0011	3/4"		15/60
239 0012	1"		8/32
239 0020	1"1/4		5/20



2380G07

Robinet F/F ISO 7/EN 10226 cu maneta de otel de culoare galbena

Cod	Dimensiune	Pret €	Ambalare
239 0001	1/2"		20/80
239 0006	3/4"		14/56
239 0007	1"		10/40
239 0004	1"1/4		6/24
239 0002	1"1/2		3/12
239 0005	2"		2/8



2381G07

Robinet M/F ISO 7/EN 10226 cu maneta de otel de culoare galbena

Cod	Dimensiune	Pret €	Ambalare
239 0013	1/2"		20/80
239 0014	3/4"		14/56
239 0015	1"		8/32
239 0018	1"1/4		6/24
239 0017	1"1/2		3/12
239 0019	2"		2/8

DIMENSIUNI

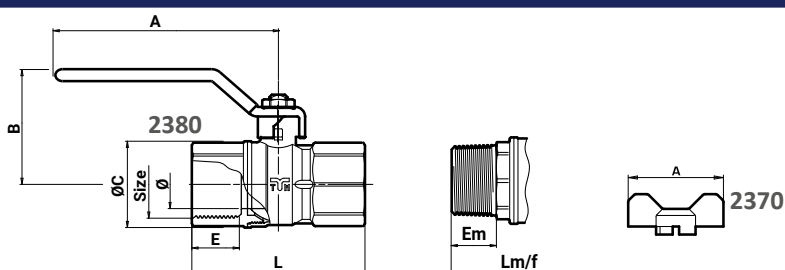

Dimensiune	Mod.	1/2"	3/4"	1"	1" 1/4	1" 1/2	2"
Ø (DN)	toate	14,0	18,0	23,5	30,0	37,5	47,0
A	2370/2371	50,0	50,0	65,0	65,0	-	-
	2380/2381	85,0	85,0	113,0	113,0	141,0	141,0
B	toate	48,0	52,5	59,5	64,5	76,0	89,0
Ø C	toate	27,5	33,5	42,0	53,0	64,0	79,0
E	ISO7	17,0	18,0	21,5	24,0	24,0	28,5
Em	ISO7	16,5	18,0	21,0	23,5	23,5	28,0
L	ISO7	58,0	66,5	78,0	93,0	101,0	121,0
Lm/f	ISO7	63,5	72,0	83,0	99,1	108,0	129,0
PN		30	30	30	25	25	25

Toate dimensiunile cu exceptia PN-ului sunt exprimate in mm



2200G

Robinet F/F ISO 7/EN 10226 cu maneta de oțel de culoare galbena



Cod	Dimensiune	Pret €	Ambalare
221 0024	1/4"		25/100
221 0018	3/8"		25/100
221 0001	1/2"		20/80
221 0003	3/4"		10/40
221 0007	1"		8/32
221 0010	1"1/4		4/16
221 0011	1"1/2		3/12
221 0005	2"		2/8
221 0013	2"1/2		1/4
221 0014	3"		1/3
221 0019	4"		1/1

MOP 5



2201G

Robinet M/F ISO 7/EN 10226 cu maneta de oțel de culoare galbena



Cod	Dimensiune	Pret €	Ambalare
221 0012	1/2"		20/80
221 0016	3/4"		10/40
221 0017	1"		8/32
221 0022	1"1/4		4/16
221 0023	1"1/2		3/12
221 0025	2"		2/8

MOP 5



2220G

Robinet F/F ISO 7/EN 10226 cu maneta tip fluture, sigilabila, de culoare galbena



Cod	Dimensiune	Pret €	Ambalare
221 0031	1/4"		25/100
221 0020	3/8"		25/100
221 0002	1/2"		20/80
221 0006	3/4"		15/60
221 0009	1"		8/32

MOP 5



2221G

Robinet M/F ISO 7/EN 10226 cu maneta tip fluture, sigilabila, de culoare galbena



Cod	Dimensiune	Pret €	Ambalare
221 0026	3/8"		25/100
221 0004	1/2"		20/80
221 0008	3/4"		15/60
221 0015	1"		8/32

MOP 5



01_B ROBINETI CU SFERA "URAGANO" PENTRU GAZ - EN 331

EN 331



2240G

Robinet F/F ISO 7/EN 10226
versiune sigilabila din alama
si capac din plastic de culoare
galbena



2241G

Robinet M/F ISO 7/EN 10226
versiune sigilabila din alama
si capac din plastic de culoare
galbena



Cod	Dimensiune	Pret €	Ambalare
221 0033	1/2"		25/100
221 0029	3/4"		15/60
221 0021	1"		8/32
221 0030	1"1/4		4/16
221 0027	1"1/2		3/12
221 0028	2"		2/8

MOP 5

Cod	Dimensiune	Pret €	Ambalare
221 0035	1/2"		25/100
221 0032	3/4"		15/60
221 0036	1"		8/32
221 0037	1"1/4		4/16
221 0038	1"1/2		3/12
221 0034	2"		2/8

MOP 5

DIMENSIUNI

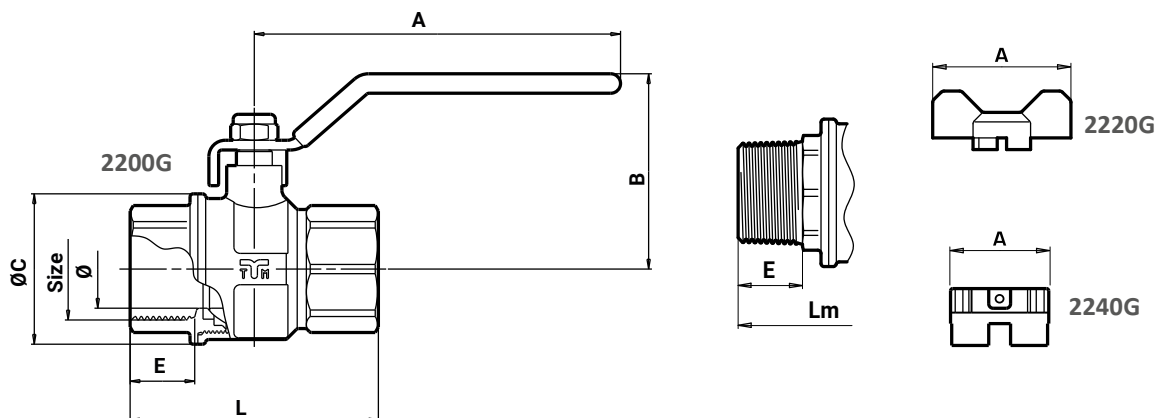

Dimensiune	1/4"	3/8"	1/2"	3/4"	1"	1"1/4	1"1/2	2"	2"1/2	3"	4"
Ø (DN)	10	10	15	20	25	32	40	50	65	80	100
A 2200G	85	85	85	113	113	141	141	141	240	240	240
A 2220G	50	50	50	65	65	-	-	-	-	-	-
A 2240G	-	-	22	27	27	32	32	32	-	-	-
B	39	39	44.5	53.5	57.5	73.5	79.5	92	125.5	136	150.5
ØC	23	23	32.5	39	48	59	71	86	114	131	164
E	10	12	16.5	18	20.6	23.5	23.5	28	34	37	43
L	42	47	59.5	67.5	79	96	105	126	156	177	214
Em	-	11.5	16.5	18	21	23.5	23.5	28	-	-	-
Lm	-	57	67.5	75.5	87	106	114	136.5	-	-	-
PN	50	50	64	40	40	30	30	30	20	20	20

Toate dimensiunile cu exceptia PN-ului sunt exprimate in mm



PCONT01

Robinet drept M/F (M ISO 228/F ISO 7) cu sfera, trecere totala si priză pentru citirea presiunii

Cod	Dimensiune	Pret €	Ambalare
221 0050	3/4" F x 1" 1/4 M		10/40
221 0066	1" F x 1" 1/4 M		6/24



PCONT01SER

Robinet drept M/F (M ISO 228/F ISO 7) cu sfera, trecere totala si priză pentru citirea presiunii, cu inchidere dubla

Cod	Dimensiune	Pret €	Ambalare
221 0052	3/4" F x 1" 1/4 M		5/20
221 0068	1" F x 1" 1/4 M		5/20



PCONT02

Robinet drept F/F cu sfera, trecere totala si priză pentru citirea presiunii

Cod	Dimensiune	Pret €	Ambalare
221 0054	3/4" F x 3/4" F		10/40
221 0070	1" F x 1" F		5/20



PCONT02SER

Robinet drept F/F ISO 7 cu sfera, trecere totala priză pentru citirea presiunii si inchidere dubla

Cod	Dimensiune	Pret €	Ambalare
221 0056	3/4" F x 3/4" F		5/20
221 0072	1" F x 1" F		5/20



PCONT03

Robinet drept cu sfera, trecere totala si priză pentru citirea presiunii, cu filet masculin (feminin) pe curba rotativa la 360° si feminin pe piulita

Se infileteaza direct pe contor

Cod	Dimensiune	Pret €	Ambalare
221 0058	1" M (3/4" F) x 1" 1/4 F		5/20



PCONT03SER

Robinet drept cu sfera, trecere totala si priză pentru citirea presiunii, cu filet masculin (feminin) ISO 7 pe cotul rotativ la 360° si feminin ISO 228 pe piulita, cu inchidere dubla

Se infileteaza direct pe contor

Cod	Dimensiune	Pret €	Ambalare
221 0060	1" M (3/4" F) x 1" 1/4 F		5/20



PCONT04

Robinet drept F/F cu trecere totala si piulita

Se infileteaza direct pe contor

Cod	Dimensiune	Pret €	Ambalare
221 0062	1" F x 1" 1/4 F		5/20



PCONT04SER

Robinet drept F/F (F ISO 7/F ISO 228) cu trecere totala, piulita, inchidere dubla

Se infileteaza direct pe contor

Cod	Dimensiune	Pret €	Ambalare
221 0064	1" F x 1" 1/4 F		5/20



PCONT05

Robinet M/F (M ISO 228/F ISO 7) de colt cu trecere totala si priză pentru citirea presiunii

Cod	Dimensiune	Pret €	Ambalare
221 0074	3/4" F x 1" 1/4 M		10/40
221 0078	1" F x 1" 1/4 M		5/20



PCONT05SER

Robinet M/F (M ISO 228/F ISO 7) de colt cu trecere totala, priză pentru citirea presiunii, inchidere dubla

Cod	Dimensiune	Pret €	Ambalare
221 0076	3/4" F x 1" 1/4 M		5/20
221 0080	1" F x 1" 1/4 M		5/20



PCONT07

Robinet F/F ISO 7 de colt cu trecere totala si priză pentru citirea presiunii

Cod	Dimensiune	Pret €	Ambalare
221 0083	3/4" F x 3/4" F		10/40
221 0084	1" F x 1" F		5/20



PCONT07SER

Robinet F/F ISO 7 de colt cu trecere totala, priză pentru citirea presiunii, inchidere dubla

Cod	Dimensiune	Pret €	Ambalare
221 0085	3/4" F x 3/4" F		5/20
221 0086	1" F x 1" F		5/20



PCONT06

Set niplu, piulita si garnitura cu filet masculin

Cod	Dimensiune	Pret €	Ambalare
221 0082	1" M x 1" 1/4 F		1/50



PCONT08

Robinet de siguranță cu priză pentru citirea presiunii

Cod	Dimensiune	Pret €	Ambalare
221 0088	1/4"		1/50

TUTORIAL VIDEO



Robineti de instalat dupa montarea contorului de gaz



2225G
Robinet de colt pentru gaz F / F ISO 7/EN 10226 cu maneta tip fluture de culoare galbena

Cod	Dimensiune	Pret €	Ambalare
222 0061	1/2"		15/60

NOU TATI



2218G
Robinet de colt pentru gaz M/F ISO 7/EN 10226 cu maneta tip fluture de culoare galbena

Cod	Dimensiune	Pret €	Ambalare
222 0073	1/2"		20/80

NOU TATI



2219G
Robinet de colt pentru gaz F/M ISO 7/EN 10226 cu maneta tip fluture de culoare galbena

Cod	Dimensiune	Pret €	Ambalare
222 0074	1/2"		20/80



2223G
Robinet de colt ISO 7/EN 10226 cu maneta tip fluture de culoare galbena

Cod	Dimensiune	Pret €	Ambalare
222 0001	1/2"		20/80
222 0016	3/4"		10/40



2262G
Robinet de colt F ISO 7/EN 10226 cu maneta tip fluture de culoare galbena cu piulita

Cod	Dimensiune	Pret €	Ambalare
222 0012	1/2"		20/80



2224G
Robinet de colt M ISO 7/EN 10226 cu maneta tip fluture de culoare galbena cu piulita

Cod	Dimensiune	Pret €	Ambalare
222 0002	1/2" M x 1/2" F		20/80
222 0005	1/2" M x 3/4" F		20/80
222 0010	3/4" M x 3/4" F		10/40



2263G
Robinet drept F ISO 228 cu maneta tip fluture, sigilabila, de culoare galbena, cu piulita

Cod	Dimensiune	Pret €	Ambalare
222 0015	1/2" x 1/2"		20/80
222 0008	3/4" x 3/4"		20/80
222 0017	1" x 1"		10/40
222 0040	1/2" x 3/4"		20/80
222 0041	3/4" x 1"		10/40

Versiunea nichelata



2266G
Robinet drept pentru gaz M cu piulita si maneta tip fluture de culoare galbena

Cod	Dimensiune	Pret €	Ambalare
222 0058	1/2" M ISO7 - 1/2" F		20/80
222 0059	1/2" M ISO7 - 3/4" F		20/80
222 0060	3/4" M - 3/4" F		20/80



LISTA DE PRETURI

02 RACORDURI DE COMPRESIE PENTRU TUB MULTISTRAT "AL-COBRAPEX"

Seria 1600

Racorduri de compresie pentru tub multistrat "AL-COBRAPEX"



62

Robineti cu capete de compresie pentru tub multistrat "AL-COBRAPEX"



68



GHID DE COMPATIBILITATE

Seria	Tub potrivit	Domeniu de aplicare	Caracteristici tehnice
1600	Multistrat "AL-COBRAPEX"	• Apa	Tmax: + 95 °C Pmax: 10 bar

Pentru detalii suplimentare consultati fisa tehnica



1600
Racord drept M

Cod	Dimensiune	Pret €	Ambalare
160 0046	16 x 3/8"		10/100
160 0001	16 x 1/2"		10/100
160 0031	16 x 3/4"		5/100
160 0007	20 x 1/2"		5/100
160 0005	20 x 3/4"		5/100
160 0187	20 x 1"		5/50
160 0075	25 x 3/4"		5/100
160 0098	25 x 1"		5/100
160 0010	26 x 3/4"		5/50
160 0015	26 x 1"		5/50
160 0020	32 x 1"		5/50
340 0028	40 x 1"		2/20
340 0004	40 x 1" 1/4		2/20
340 0186	40 x 1" 1/2		2/20
340 0009	50 x 1" 1/2		2/10
340 0007	63 x 2"		1/10
340 0079	75 x 2"		1/10
340 0036	75 x 2" 1/2		1/10
340 0078	90 x 2" 1/2		1/6
340 0038	90 x 3"		1/6

De utilizat obligatoriu cu art. 1476

Varianta galbena la cerere



1600OR
Racord drept M cu O-ring,
pentru colectoare bara

Cod	Dimensiune	Pret €	Ambalare
160 0022	16 x 1/2"		10/100
160 0072	20 x 1/2"		5/100



1602
Racord drept F

Cod	Dimensiune	Pret €	Ambalare
160 0069	16 x 3/8"		10/100
160 0004	16 x 1/2"		10/100
160 0035	16 x 3/4"		5/100
160 0016	20 x 1/2"		5/100
160 0011	20 x 3/4"		5/100
160 0188	20 x 1"		5/100
160 0092	25 x 3/4"		5/100
160 0112	25 x 1"		5/50
160 0021	26 x 3/4"		5/100
160 0029	26 x 1"		5/100
160 0039	32 x 1"		5/50
340 0013	40 x 1" 1/4		2/20
340 0187	40 x 1" 1/2		2/20
340 0034	50 x 1" 1/2		2/10
340 0189	50 x 2"		2/10
340 0026	63 x 2"		1/10
340 0054	75 x 2" 1/2		1/10
340 0061	90 x 3"		1/6

De utilizat obligatoriu cu art. 1476

Varianta galbena la cerere



1614BP
Racord drept cu piulita si
GARNITURA PLATA

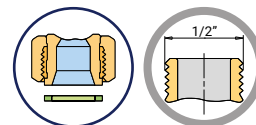

Cod	Dimensiune	Pret €	Ambalare
160 0167	16 x 3/8"		5/100
160 0156	16 x 1/2"		5/100
160 0168	16 x 3/4"		5/100
160 0169	20 x 1/2"		5/100
160 0157	20 x 3/4"		5/100
160 0435	20 x 1"		5/50
160 0170	26 x 3/4"		5/50
160 0171	26 x 1"		5/50
160 0166	32 x 1"		5/25
160 0172	32 x 1" 1/4		2/20
160 0173	32 x 1" 1/2		2/20



1601
Racord drept dublu

Cod	Dimensiune	Pret €	Ambalare
160 0012	16 x 16		10/100
160 0053	20 x 16		5/100
160 0024	20 x 20		5/100
160 0104	25 x 25		5/50
160 0160	26 x 16		5/50
160 0081	26 x 20		5/50
160 0045	26 x 26		5/50
160 0161	32 x 16		5/25
160 0159	32 x 20		5/25
160 0148	32 x 26		5/25
160 0056	32 x 32		5/25
340 0029	40 x 40		2/10
340 0025	50 x 50		2/8
340 0015	63 x 63		1/8
340 0039	75 x 75		1/6
340 0042	90 x 90		1/6

De utilizat obligatoriu cu art. 1476

Varianta galbena la cerere

Până la terminarea stocului



1601KB
Racord drept dublu de
compresie pentru tub
multistrat/cupru

i Varianta galbena la cerere

Cod	Dimensiune	Pret €	Ambalare
160 0145	16 x 2 - Ø15		10/100



1604
Cot M

Cod	Dimensiune	Pret €	Ambalare
160 0013	16 x 1/2"		10/100
160 0066	16 x 3/4"		5/100
160 0042	20 x 1/2"		10/100
160 0028	20 x 3/4"		5/100
160 0189	20 x 1"		5/50
160 0116	25 x 3/4"		5/50
160 0119	25 x 1"		5/50
160 0050	26 x 3/4"		5/50
160 0051	26 x 1"		5/50
160 0067	32 x 1"		5/25
340 0044	40 x 1" 1/4		2/10
340 0053	50 x 1" 1/2		2/8
340 0062	63 x 2"		1/4
340 0076	75 x 2" 1/2		1/5
340 0128	90 x 3"		1/4

De utilizat obligatoriu cu art. 1476

Varianta galbena la cerere



1605
Cot F

Cod	Dimensiune	Pret €	Ambalare
160 0006	16 x 1/2"		10/100
160 0061	16 x 3/4"		5/100
160 0126	16 (2,25) x 1/2"		10/100
160 0026	20 x 1/2"		5/100
160 0023	20 x 3/4"		5/50
160 0133	20 (2,5) x 3/4"		5/50
160 0190	20 x 1"		5/50
160 0093	25 x 3/4"		5/50
160 0117	25 x 1"		5/50
160 0034	26 x 3/4"		5/50
160 0052	26 x 1"		5/50
160 0060	32 x 1"		5/25
340 0035	40 x 1" 1/4		2/10
340 0051	50 x 1" 1/2		2/8
340 0048	63 x 2"		1/5
340 0074	75 x 2" 1/2		1/5
340 0129	90 x 3"		1/3

De utilizat obligatoriu cu art. 1476

Varianta galbena la cerere



1615BP
Racord cot cu piulita si
GARNITURA PLATA

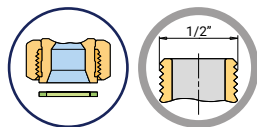

Cod	Dimensiune	Pret €	Ambalare
160 0162	16 X 3/8"		5/100
160 0151	16 x 1/2"		5/100
160 0152	16 x 3/4"		5/100
160 0153	20 x 1/2"		5/100
160 0154	20 x 3/4"		5/100
160 0434	20 x 1"		5/50
160 0155	26 x 3/4"		5/50
160 0163	26 x 1"		5/50
160 0164	32 x 1"		5/25



1606
Cot F cu flansa

Cod	Dimensiune	Pret €	Ambalare
160 0003	16 x 1/2"		10/100
160 0096	16 x 3/4"		5/50
160 0027	20 x 1/2"		5/50
160 0055	20 x 3/4"		5/50

Varianta galbena la cerere



1616
Consola cu racorduri finale

i Interaxe variabile:
100 - 110 - 150 mm

Cod	Dimensiune	Pret €	Ambalare
160 0346	16 x 2,0 - 1/2"		1/20
160 0347	20 x 2,0 - 1/2"		1/20

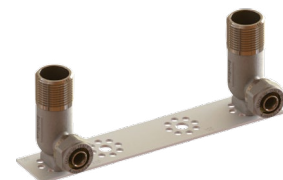

1616M
Consola cu racorduri finale

i Interaxe variabile:
100 - 110 - 150 mm

Cod	Dimensiune	Pret €	Ambalare
160 0344	16 x 2,0 - 3/4"		1/20
160 0345	20 x 2,0 - 3/4"		1/20



1612C
Cot masculin cu flanșă (cromată
lucioasă)

i Furnizat cu holsurub si diblu

Cod	Dimensiune	Pret €	Ambalare
045 0605	16 x 2,0 - 3/4"		1/100
045 0627	20 x 2,0 - 3/4"		1/100



**1613C**

Cot feminin cu flanșă (cromată lucioasă)

i FURNIZAT CU HOLSURUB SI DIBLU

Cod	Dimensiune	Pret €	Ambalare
045 0584	16 x 2,0 - 1/2"		1/100
045 0628	20 x 2,0 - 1/2"		1/100

**1603**

Cot dublu

Cod	Dimensiune	Pret €	Ambalare
160 0008	16 x 16		10/100
160 0014	20 x 20		5/50
160 0105	25 x 25		5/50
160 0019	26 x 26		5/50
160 0036	32 x 32		5/25
340 0017	40 x 40		2/10
340 0020	50 x 50		2/6
340 0024	63 x 63		1/4
340 0059	75 x 75		1/4
340 0127	90 x 90		1/3

De utilizat obligatoriu cu art. 1476

Varianta galbena la cerere

**1626**

Cot F, dublu cu flansa

Cod	Dimensiune	Pret €	Ambalare
160 0063	16 x 1/2" x 16		5/60
160 0165	16 x 3/4" x 16		5/50
160 0106	20 x 1/2" x 20		5/40

**1608**

Teu M

Cod	Dimensiune	Pret €	Ambalare
160 0038	16 x 1/2" x 16		5/100
160 0058	20 x 1/2" x 20		5/50
160 0076	20 x 3/4" x 20		5/50
160 0129	25 x 3/4" x 25		5/50
160 0132	25 x 1" x 25		5/45
160 0070	26 x 3/4" x 26		5/50
160 0087	26 x 1" x 26		5/45
160 0085	32 x 1" x 32		5/20
340 0075	40 x 1" 1/4 x 40		2/10
340 0086	50 x 1" 1/2 x 50		2/8
340 0090	63 x 2" x 63		1/5
340 0130	75 x 2" x 75		1/3
340 0131	90 x 2" x 90		1/2

De utilizat obligatoriu cu art. 1476

**1619**

Teu cu filet lateral M nichelat

Cod	Dimensiune	Pret €	Ambalare
160 0194	16 x 16 x 1/2"		5/50
160 0195	20 x 20 x 3/4"		5/50



1609
Teu F

Cod	Dimensiune	Pret €	Ambalare
160 0018	16 x 1/2" x 16		5/50
160 0049	20 x 1/2" x 20		5/50
160 0032	20 x 3/4" x 20		5/50
160 0107	25 x 3/4" x 25		5/25
160 0123	25 x 1" x 25		5/25
160 0174	26 x 1/2" x 26		5/25
160 0033	26 x 3/4" x 26		5/25
160 0079	26 x 1" x 26		5/25
160 0048	32 x 1" x 32		5/20
340 0045	40 x 1" 1/4 x 40		2/8
340 0049	50 x 1" 1/2 x 50		2/6
340 0058	63 x 2" x 63		1/3
340 0085	75 x 2" x 75		1/3
340 0084	90 x 2" 1/2 x 90		1/2

De utilizat obligatoriu cu art. 1476



1620
Teu cu filet lateral F nichelat

Cod	Dimensiune	Pret €	Ambalare
160 0192	16 x 16 x 1/2"		5/50
160 0193	20 x 20 x 3/4"		5/50



1607
Teu

Cod	Dimensiune			Pret €	Ambalare
	1	2	3		
160 0002	16	16	16		5/50
160 0009	20	20	20		5/50
160 0101	25	25	25		5/25
160 0030	26	26	26		5/25
160 0054	32	32	32		5/15
340 0050	40	40	40		2/6
340 0055	50	50	50		2/4
340 0060	63	63	63		1/2
340 0083	75	75	75		1/2
340 0081	90	90	90		1/1
Redus					
160 0078	16	20	16		5/50
160 0181	16	26	16		5/50
160 0044	20	16	16		5/50
160 0017	20	16	20		5/50
160 0057	20	20	16		5/50
160 0089	20	26	20		5/50
160 0433	25	16	20		5/50
160 0432	25	16	25		5/25
160 0431	25	20	20		5/25
160 0177	26	16	16		5/25
160 0183	26	16	20		5/50
160 0043	26	16	26		5/25
160 0184	26	20	16		5/50
160 0080	26	20	20		5/25
160 0037	26	20	26		5/25
160 0175	26	26	16		5/25
160 0090	26	26	20		5/25
160 0182	26	32	26		5/20
160 0179	32	16	32		5/25
160 0178	32	20	20		5/25
160 0185	32	20	26		5/25
160 0062	32	20	32		5/25
160 0095	32	26	26		5/20
160 0082	32	26	32		5/20
160 0176	32	32	20		5/25
160 0180	32	32	26		5/20

De utilizat obligatoriu cu art. 1476

Varianta galbena la cerere



LISTA DE PREȚURI



1610
Cruce

Cod	Dimensiune	Pret €	Ambalare
160 0071	16 x 16 x 16 x 16		5/50
160 0088	20 x 20 x 20 x 20		5/40



1611
Dop final

Cod	Dimensiune	Pret €	Ambalare
160 0083	16		10/100
160 0102	20		5/100
160 0191	25		5/50



1481
Placa pentru cot cu flansa

1606 - 1626

Cod	Dimensiune	Pret €	Ambalare
147 0005	unica		1/100



1476
Stut cu garnituri pentru tub multistrat

i Articolul obligatoriu în cazul utilizării fittingurilor din seria 1600 cu tubul multistrat cu dimensiuni de Ø 40, 50, 63, 75 și 90 mm

i "Dimensiune" se referă la dimensiunile tubului

+ CU FUNCȚIE DIELECTRICĂ

Cod	Dimensiune	Pret €	Ambalare
340 0067	40 x 3,5		10/60
340 0080	50 x 4,0		5/30
340 0087	63 x 4,5		1/25
340 0178	75 x 5,0		1/20
340 0179	90 x 7,0		1/15



H9300
O-ring

Cod	Dimensiune	Pret €	Ambalare
040 0100	16		250/1500
040 0101	20		250/1500
040 0102	25-26		250/1500
040 0103	32		250/1500



1416
Inel din alama

Cod	Dimensiune	Pret €	Ambalare
140 0159	16		50/2300
140 0204	20		50/1200
140 0225	25		50/800
140 0637	26		50/800
140 0220	32		10/400



**2143**

Robinet pentru tub multistrat cu maneta de aluminiu de culoare rosie

Cod	Dimensiune	Pret €	Ambalare
162 0022	16 x 2,0		20/80
162 0005	20 x 2,0		15/60

**2153**

Robinet pentru tub multistrat cu maneta tip fluture de culoare rosie și albastra

Cod	Dimensiune	Pret €	Ambalare
 maneta tip fluture rosie			
162 0020	16 x 2,0		20/80
162 0003	20 x 2,0		15/60
162 0084	26 x 3,0		10/40
 maneta tip fluture albastra			
162 0021	16 x 2,0		20/80
162 0053	20 x 2,0		15/60
162 0086	26 x 3,0		10/40



**2163**

Robinet pentru tub multistrat cu maneta de otel de culoare rosie

Cod	Dimensiune	Pret €	Ambalare
162 0023	16 x 2,0		20/80
162 0007	20 x 2,0		15/60
162 0087	26 x 3,0		10/40



**2153FLR**

Robinet pentru tub multistrat cu maneta tip fluture de culoare rosie și albastra

Cod	Dimensiune	Pret €	Ambalare
 maneta tip fluture rosie			
162 0029	16 x 2,0		20/80
162 0031	20 x 2,0		15/60
 maneta tip fluture albastra			
162 0030	16 x 2,0		20/80
162 0032	20 x 2,0		15/60



**2154R**

Robinet M pentru tub multistrat cu maneta tip fluture de culoare rosie și albastra

Cod	Dimensiune	Pret €	Ambalare
 maneta tip fluture rosie			
162 0025	16 x 2,0 - 1/2"		20/80
162 0037	20 x 2,0 - 3/4"		15/60
162 0092	26 x 3,0 - 1"		10/40
 maneta tip fluture albastra			
162 0026	16 x 2,0 - 1/2"		20/80
162 0038	20 x 2,0 - 3/4"		15/60
162 0093	26 x 3,0 - 1"		10/40



**2154FLR**

Robinet M pentru tub multistrat cu maneta tip fluture de culoare rosie și albastra

Cod	Dimensiune	Pret €	Ambalare
 maneta tip fluture rosie			
162 0035	16 x 2,0 - 1/2"		20/80
162 0041	20 x 2,0 - 3/4"		15/60
 maneta tip fluture albastra			
162 0036	16 x 2,0 - 1/2"		20/80
162 0042	20 x 2,0 - 3/4"		15/60



**2155R**

Robinet F pentru tub multistrat cu maneta tip fluture de culoare rosie și albastra

Cod	Dimensiune	Pret €	Ambalare
 maneta tip fluture rosie			
162 0027	16 x 2,0 - 1/2"		20/80
162 0039	20 x 2,0 - 3/4"		15/60
162 0100	26 x 3,0 - 1"		10/40
 maneta tip fluture albastra			
162 0028	16 x 2,0 - 1/2"		20/80
162 0040	20 x 2,0 - 3/4"		15/60
162 0101	26 x 3,0 - 1"		10/40



**2155FLR**

Robinet F pentru tub multistrat cu maneta tip fluture de culoare rosie și albastra

Cod	Dimensiune	Pret €	Ambalare
 maneta tip fluture rosie			
162 0033	16 x 2,0 - 1/2"		20/80
162 0043	20 x 2,0 - 3/4"		15/60
 maneta tip fluture albastra			
162 0034	16 x 2,0 - 1/2"		20/80
162 0044	20 x 2,0 - 3/4"		15/60

**2161**

Robinet pentru tub multistrat cu maneta de aluminiu si piulita

Cod	Dimensiune	Pret €	Ambalare
 maneta tip levier rosie			
162 0122	26 x 3,0 - 3/4"		10/40
162 0124	26 x 3,0 - 1"		10/40
 maneta tip levier albastra			
162 0121	26 x 3,0 - 3/4"		10/40
162 0123	26 x 3,0 - 1"		10/40



**2160**

Robinet pentru tub multistrat cu maneta tip fluture si piulita

Cod	Dimensiune	Pret €	Ambalare
 maneta tip fluture rosie			
162 0112	16 x 2,0 - 1/2"		20/80
162 0114	16 x 2,0 - 3/4"		15/60
162 0116	20 x 2,0 - 3/4"		15/60
162 0118	26 x 3,0 - 3/4"		10/40
162 0120	26 x 3,0 - 1"		10/40
 maneta tip fluture albastra			
162 0111	16 x 2,0 - 1/2"		20/80
162 0113	16 x 2,0 - 3/4"		15/60
162 0115	20 x 2,0 - 3/4"		15/60
162 0117	26 x 3,0 - 3/4"		10/40
162 0119	26 x 3,0 - 1"		10/40



**2156R**

Robinet de colt M pentru tub multistrat cu maneta tip fluture de culoare rosie și albastra

Cod	Dimensiune	Pret €	Ambalare
 maneta tip fluture rosie			
162 0051	20 x 2,0 - 3/4"		15/60
 maneta tip fluture albastra			
162 0052	20 x 2,0 - 3/4"		15/60



**2157R**

Robinet de colt pentru tub multistrat cu maneta tip fluture de culoare rosie, albastra si piulita

Cod	Dimensiune	Pret €	Ambalare
	maneta tip fluture rosie		
162 0047	20 x 2,0 - 3/4"		10/40
162 0060	20 x 2,0 - 1"		10/40
162 0049	26 x 3,0 - 3/4"		10/40
162 0062	26 x 3,0 - 1"		10/40
	maneta tip fluture albastra		
162 0048	20 x 2,0 - 3/4"		10/40
162 0061	20 x 2,0 - 1"		10/40
162 0050	26 x 3,0 - 3/4"		10/40
162 0063	26 x 3,0 - 1"		10/40

**2158**

Robinet de colt pentru tub multistrat cu maneta tip fluture si piulita

Cod	Dimensiune	Pret €	Ambalare
	maneta tip fluture rosie		
162 0125	16 x 2,0 - 1/2"		10/60
	maneta tip fluture albastra		
162 0126	16 x 2,0 - 1/2"		10/60

**0191X**



Pereche racorduri flexible din otel inox DN8 pentru tub multistrat Ø16x2,0 si M10x1

Cod	Dimensiune	Pret €	Ambalare
019 0009	L = 30 cm		1/20

**2181CPR**

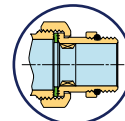

Robinet de colt pentru tub multistrat cu racord olandez, **GARNITURA PLATA** cu pre-etansare



Cod	Dimensiune	Pret €	Ambalare
	maneta tip fluture rosie		
162 0045	20 x 3/4"		10/40
162 0014	26 x 3/4"		10/40
162 0010	26 x 1"		5/20
162 0015	32 x 1"		5/20
	maneta tip fluture albastra		
162 0046	20 x 3/4"		10/40
162 0004	26 x 3/4"		10/40
162 0009	26 x 1"		5/20
162 0013	32 x 1"		5/20



**2944**

Mini-robinet cu sfera pentru tub multistrat cu maneta aluminiu de culoare rosie sau albastra

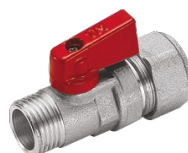
Cod	Dimensiune	Pret €	Ambalare
	maneta tip fluture rosie		
294 0029	16 x 2,0 - 1/2"		25/100
	maneta tip fluture albastra		
294 0028	16 x 2,0 - 1/2"		25/100

**2944K**

Mini-robinet cu sfera cromata pentru tub multistrat cu maneta aluminiu de culoare rosie sau albastra

Cod	Dimensiune	Pret €	Ambalare
	maneta tip fluture rosie		
294 0026	16 x 2,0 - 1/2"		1/50
	maneta tip fluture albastra		
294 0027	16 x 2,0 - 1/2"		1/50

INSTRUCTIUNI DE MONTAJ Ø14 - Ø32

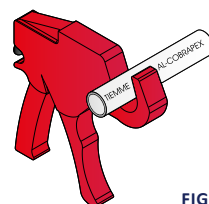
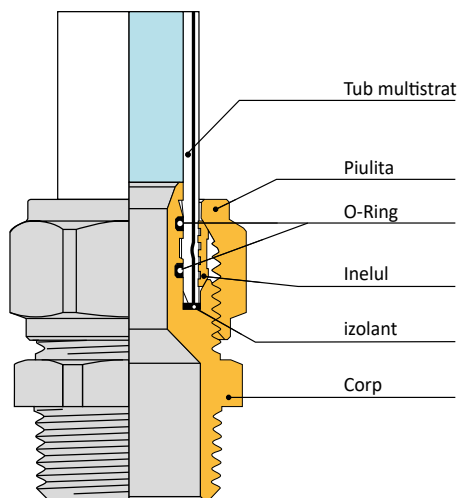

FIG. 1

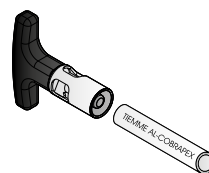

FIG. 2

Pentru a obtine o imbinare perfecta si in functie de tipul de racord care va fi utilizat, trebuie indeplinite urmatoarele operatii simple dar importante.

TAIEREA TUBULUI

In primul rand, taiati tubul la marimea dorita, folosind o foarfeca speciala pentru tuburi, avand grija ca taietura sa se faca perpendicular pe axa tubului (FIG. 1)

DEBAVURAREA SI CURATIREA TUBULUI

Apoi, calibrati si debavurati tubul, folosind calibratorul debavurator din FIG. 2. Se introduce calibratorul in tub si se roteste in sensul acelor de ceas si in sens invers.

MONTAJUL RACORDULUI

In cazul racordurilor mecanice prin compresie, introduceti pe tub toate componentele racordului; in ordinea:

1. piulita de strangere
2. inelul de strangere

Introduceti tubul pe racord pana la inelul izolant; strangeti piulita cu mana cat este posibil si apoi strangeti piulita cu cheia, conform numarului de rotatii din tabelul de mai jos.

TABEL DE STRANGERE PIULITA - Nr. rotatii

Dimensiune	16	20	25	26	32
Nr. rotatii	1 1/4	1	1	1	1

INSTRUCTIUNI DE MONTAJ Ø40 - Ø63

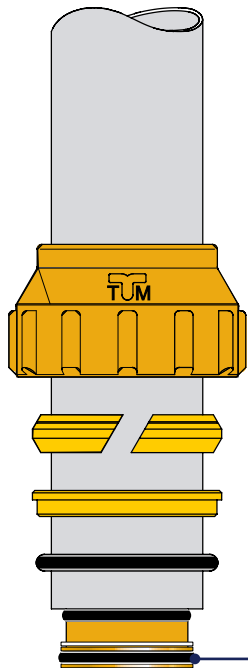

Art. 1476
Stut cu garnituri pentru tub multistrat
(obligatoriu)

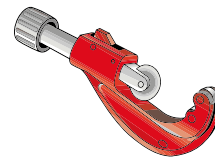
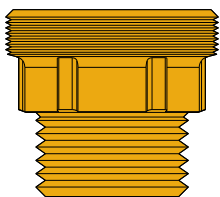

FIG. 1

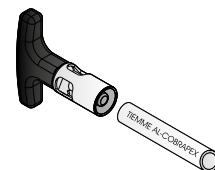

FIG. 2

Pentru a obtine o imbinare perfecta si in functie de tipul de racord care va fi utilizat, trebuie indeplinite urmatoarele operatii simple dar importante.

TAIEREA TUBULUI

In primul rand, taiati tubul la marimea dorita, folosind o foarfeca speciala pentru tuburi, avand grija ca taitura sa se faca perpendicular pe axa tubului (FIG. 1)

DEBAVURAREA SI CURATAREA TEVII

Apoi, calibrati si debavurati tubul, folosind calibratorul debavurator din FIG. 2. Se introduce calibratorul in tub si se roteste in sensul acelor de ceas si in sens invers.

MONTAJUL RACORDULUI

Introduceti piulita si o-ring-ul sectionat pe tub, montati-l la extremitatea tubului, asigurandu-va ca nu rupeti garnitura in scaunul fittingului. Insurubati piulita manual, urmand indicatiile de strangere din tabelul de mai jos.

TABEL DE STRANGERE PIULITA - Nr. rotatii

Dimensiune	40	50	63
Nr. rotatii	1,5	1,5	1,5



03 RACORDURI DE PRESARE PENTRU TUB MULTISTRAT "AL-COBRAPEX"



Seria 1650 - Racorduri de presare pentru apă

Racorduri de presare pentru tub multistrat "AL-COBRAPEX" - COMPACT		74
Racorduri de presare pentru tub multistrat "AL-COBRAPEX"		76
Accesorii si piese de schimb		92
Robineti de presare pentru tub multistrat "AL-COBRAPEX"		93

GHID DE COMPATIBILITATE

Seria	Tub potrivit	Domeniu de aplicare	Caracteristici tehnice
1650	Multistrat "AL-COBRAPEX"	• Apa	Tmax: + 95 °C Pmax: 10 bar

Pentru detalii suplimentare consultati fisa tehnica



1650CT
Racord drept M

i Disponibil și în varianta staniu

Cod	Dimensiune	Pret €	Ambalare
166 0004	16 x 2,0 - 1/2"		10/100
166 0031	16 x 2,0 - 3/4"		10/100
166 0006	20 x 2,0 - 1/2"		10/100
166 0018	20 x 2,0 - 3/4"		10/100
166 0089	20 x 2,25 - 1/2"		10/100
166 0090	20 x 2,25 - 3/4"		10/100
166 0093	20 x 2,5 - 1/2"		10/100
166 0094	20 x 2,5 - 3/4"		10/100
166 0124	25 x 2,5 - 1/2"		10/50
166 0070	25 x 2,5 - 3/4"		10/50
166 0071	25 x 2,5 - 1"		5/25
166 0012	26 x 3,0 - 3/4"		10/50
166 0064	26 x 3,0 - 1"		5/25
166 0021	32 x 3,0 - 1"		5/25



1652CT
Racord drept F

i Disponibil și în varianta staniu

Cod	Dimensiune	Pret €	Ambalare
166 0009	16 x 2,0 - 1/2"		10/100
166 0010	20 x 2,0 - 1/2"		10/100
166 0092	20 x 2,25 - 1/2"		10/100
166 0193	20 x 2,25 - 3/4"		5/25
166 0096	20 x 2,5 - 1/2"		10/100
166 0125	25 x 2,5 - 1/2"		5/50
166 0016	26 x 3,0 - 3/4"		5/25
166 0065	26 x 3,0 - 1"		5/25
166 0066	32 x 3,0 - 1"		5/25



1651CT
Racord drept dublu

i Disponibil și în varianta staniu

Cod	Dimensiune	Pret €	Ambalare
166 0015	16 x 2,0 - 16 x 2,0		10/100
166 0173	16 x 2,0 - 20 x 2,25		10/100
166 0019	20 x 2,0 - 20 x 2,0		10/100
166 0097	20 x 2,0 - 20 x 2,25		10/100
166 0098	20 x 2,0 - 20 x 2,5		10/100
166 0091	20 x 2,25 - 20 x 2,25		10/100
166 0175	20 x 2,25 - 25 x 2,5		5/50
166 0095	20 x 2,5 - 20 x 2,5		10/100
166 0072	25 x 2,5 - 25 x 2,5		5/50
166 0026	26 x 3,0 - 26 x 3,0		5/50
166 0028	32 x 3,0 - 32 x 3,0		5/25



1654CT
Cot M

i Disponibil și în varianta staniu

Cod	Dimensiune	Pret €	Ambalare
166 0008	16 x 2,0 - 1/2"		10/100
166 0022	20 x 2,0 - 1/2"		10/100
166 0127	20 x 2,5 - 1/2"		10/100
166 0029	20 x 2,0 - 3/4"		10/50
166 0025	26 x 3,0 - 3/4"		5/50
166 0030	32 x 3,0 - 1"		5/25

IDENTIFICATI GROSIMEA TUBULUI PENTRU RACORDURILE SERIA COMPACT



20 x 2,0



20 x 2,25



20 x 2,5

Versiunea galbena



Versiunea placata cu staniu



LISTA DE PRETURI

**1655CT**

Cot F

i Disponibil si in varianta staniu

Cod	Dimensiune	Pret €	Ambalare
166 0003	16 x 2,0 - 1/2"		10/100
166 0007	20 x 2,0 - 1/2"		10/100
166 0167	20 x 2,0 - 3/4"		10/100
166 0191	20 x 2,25 - 1/2"		10/100
166 0128	20 x 2,5 - 1/2"		10/100
166 0073	25 x 2,5 - 3/4"		5/25
166 0014	26 x 3,0 - 3/4"		5/25
166 0027	32 x 3,0 - 1"		5/25

**1656DFCT**

Cot F cu flansa cu 2 gauri de prindere

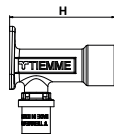

i Disponibil si in varianta staniu

Cod	Dimensiune	H	Pret €	Ambalare
166 0005	16 x 2,0 - 1/2"	40 mm		10/50
166 0023	20 x 2,0 - 1/2"	40 mm		10/50
166 0169	20 x 2,25 - 1/2"	40 mm		10/50

**1653CT**

Cot dublu

i Disponibil si in varianta staniu

Cod	Dimensiune	Pret €	Ambalare
166 0101	20 x 2,0 - 20 x 2,5		10/100
166 0100	20 x 2,25 - 20 x 2,25		10/100
166 0099	20 x 2,5 - 20 x 2,5		10/100

**1659CT**

Teu F

i Disponibil si in varianta staniu

Cod	Dimensiune	Pret €	Ambalare
166 0011	16 x 2,0 - 1/2" - 16 x 2,0		10/100
166 0020	20 x 2,0 - 1/2" - 20 x 2,0		10/100
166 0181	20 x 2,25 - 1/2" - 20 x 2,25		10/100
166 0032	26 x 3,0 - 3/4" - 26 x 3,0		5/25
166 0034	32 x 3,0 - 1" - 32 x 3,0		5/25

**1657CT**

Teu

i Disponibil si in varianta staniu

Cod	Dimensiune			Pret €	Ambalare
	1	2	3		
166 0001	16 x 2,0	16 x 2,0	16 x 2,0		10/50
166 0179	16 x 2,0	16 x 2,0	20 x 2,25		5/50
166 0002	20 x 2,0	20 x 2,0	20 x 2,0		5/50
166 0183	20 x 2,25	16 x 2,0	20 x 2,25		5/50
166 0185	20 x 2,25	20 x 2,25	16 x 2		5/50
166 0177	20 x 2,25	20 x 2,25	20 x 2,25		5/50
166 0126	20 x 2,5	20 x 2,5	20 x 2,5		5/50
166 0187	25 x 2,5	20 x 2,25	20 x 2,25		5/25
166 0189	25 x 2,5	20 x 2,25	25 x 2,5		5/25
166 0074	25 x 2,5	25 x 2,5	25 x 2,5		5/25
166 0017	26 x 3,0	26 x 3,0	26 x 3,0		5/25
166 0076	32 x 3,0	25 x 2,5	25 x 2,5		5/25
166 0075	32 x 3,0	25 x 2,5	32 x 3,0		5/25
166 0078	32 x 3,0	26 x 3,0	26 x 3,0		5/25
166 0077	32 x 3,0	26 x 3,0	32 x 3,0		5/25
166 0024	32 x 3,0	32 x 3,0	32 x 3,0		5/25



1650
Racord drept M

i Disponibil si in varianta staniu

Cod	Dimensiune	Pret €	Ambalare
165 0262	16 x 3/8"		10/100
165 0009	16 x 1/2"		10/100
165 0091	16 x 3/4"		10/100
165 0014	20 x 1/2"		10/100
165 0015	20 x 3/4"		10/100
165 0219	25 x 3/4"		10/50
165 0245	25 x 1"		5/25
165 0180	26 x 1/2"		10/50
165 0007	26 x 3/4"		10/50
165 0027	26 x 1"		5/25
165 0032	32 x 1"		5/25
165 0121	32 x 1"1/4		5/25
165 0065	40 x 1"1/4		5/25
165 1410	50 x 1"		1/16
165 0084	50 x 1"1/2		1/16
165 0089	63 x 2"		1/16
165 1109	75 x 2"1/2		1/10
165 1263	90 x 3"		1/1

La cerere



1652
Racord drept F

i Disponibil si in varianta staniu

Cod	Dimensiune	Pret €	Ambalare
165 0030	16 x 1/2"		10/100
165 0116	16 x 3/4"		10/100
165 0025	20 x 1/2"		10/100
165 1237	20 (2,25) x 3/4"		10/100
165 0033	20 x 3/4"		10/100
165 0253	25 x 3/4"		5/25
165 0268	25 x 1"		5/25
165 0020	26 x 3/4"		5/25
165 0053	26 x 1"		5/25
165 0050	32 x 1"		5/25
165 0139	32 x 1"1/4		5/25
165 0094	40 x 1"1/4		5/25
165 1217	40 x 1"1/2		5/25
165 0122	50 x 1"1/2		1/16
165 1218	63 x 2"		1/16
165 1110	75 x 2"1/2		1/10
165 1262	90 x 3"		1/1

La cerere



1651
Racord drept dublu

i Disponibil si in varianta staniu

Cod	Dimensiune	Pret €	Ambalare
165 0016	16 x 16		10/100
165 0022	20 x 20		10/100
165 0212	25 x 25		5/50
165 0037	26 x 26		5/50
165 0051	32 x 32		5/25
165 0059	40 x 40		5/25
165 0060	50 x 50		1/16
165 0068	63 x 63		1/16
165 1111	75 x 75		1/10
165 1254	90 x 90		1/1

1651 - Racord drept redus

Cod	Dimensiune	Pret €	Ambalare
Redus			
165 0040	20 x 16		10/100
165 0333	25 x 16		10/100
165 0228	25 x 20		10/100
165 0093	26 x 16		10/100
165 0052	26 x 20		10/100
165 0337	26 x 25		5/50
165 0186	32 x 16		5/25
165 0115	32 x 20		5/25
165 0288	32 x 25		5/25
165 0067	32 x 26		5/25
165 1046	40 x 25		5/25
165 0150	40 x 26		5/25
165 0103	40 x 32		5/25
165 1409	50 x 20		1/16
165 0154	50 x 32		1/16
165 0126	50 x 40		1/16
165 0170	63 x 40		1/16
165 0145	63 x 50		1/16
165 1113	75 x 50		1/2
165 1112	75 x 63		1/10
165 1261	90 x 63		1/1
165 1256	90 x 75		1/1

La cerere



1671
Prelungitor de reparatii

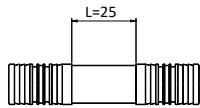

i Lungimea de tăiere = 25mm

Cod	Dimensiune	Pret €	Ambalare
165 0202	16		5/100
165 0200	20		5/100

**1667**

Racord drept M cu conector cu piulita

i Disponibil si in varianta staniu

Cod	Dimensiune	Pret €	Ambalare
165 0217	16 x 1/2"		10/100
165 0273	16 x 3/4"		10/100
165 0250	20 x 1/2"		5/100
165 0235	20 x 3/4"		5/100
165 0237	26 x 3/4"		5/25
165 0286	26 x 1"		5/25
165 0254	32 x 1"		1/40

**1668**

Racord drept cu conector cu piulita pentru conexiuni 1/2"x16 si M22x16

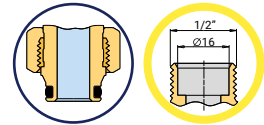

i Disponibil si in varianta staniu

Cod	Dimensiune	Pret €	Ambalare
165 0028	16 x 1/2" (ø16)		10/100
165 0077	20 x 1/2" (ø16)		10/100
Versiunea nichelata			
165 0299	16 x M22 (ø16)		5/200

Pina la terminarea stocului

**1694**

Racord drept cu conector cu piulita pentru conexiuni 1/2"x15

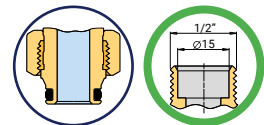

i Disponibil si in varianta staniu

Cod	Dimensiune	Pret €	Ambalare
165 0141	16 x 1/2" (ø15)		10/100
165 0264	20 x 1/2" (ø15)		10/100

**1666**

Racord drept cu piulita pentru conectare 3/4"x18 (Eurocono)

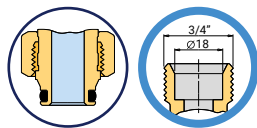

i Disponibil si in varianta staniu

Cod	Dimensiune	Pret €	Ambalare
165 0076	16 x 3/4" (ø18)		10/100
165 0110	20 x 3/4" (ø18)		10/100

**1666K24**

Racord drept cu piulita pentru conexiuni 24x19 fil (ø 18)
Versiunea cromata

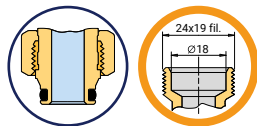

Cod	Dimensiune	Pret €	Ambalare
165 0158	16 - 24 x 19 fil (ø18)		10/100
165 0272	20 - 24 x 19 fil (ø18)		10/100

**1665**

Racord drept cu piulita si garnitura plata

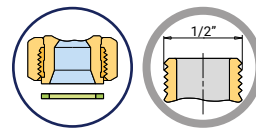

i Disponibil si in varianta staniu

Cod	Dimensiune	Pret €	Ambalare
165 0256	16 x 3/8"		10/100
165 0034	16 x 1/2"		10/100
165 0133	16 x 3/4"		10/100
165 0297	16 x 1"		10/100
165 0061	20 x 1/2"		10/100
165 0062	20 x 3/4"		10/100
165 1105	20 x 1"		10/100
165 0303	25 x 3/4"		2/100
165 0233	25 x 1"		2/50
165 0072	26 x 3/4"		2/100
165 0071	26 x 1"		2/50
165 0294	26 x 1"1/4		2/90
165 0354	32 x 3/4"		2/100
165 0134	32 x 1"		2/100
165 0161	32 x 1"1/4		2/80
165 0240	32 x 1"1/2		1/50
165 1176	40 x 1"1/4		1/25
165 0239	40 x 1"1/2		1/25
165 1177	50 x 1"1/2		1/30
165 0257	50 x 2"		1/30
165 1178	63 x 2"		1/20
165 0275	63 x 2"1/2		1/20
165 1179	75 x 2"1/2		1/10

**1651FS**

Racord drept dublu tub multistrat/FASTEC

Cod	Dimensiune	Pret €	Ambalare
165 1039	16 x 2,0 - FASTEC		10/100
165 1040	20 x 2,0 - FASTEC		10/100
165 1041	26 x 3,0 - FASTEC		5/50

**1651KB**

Racord drept dublu tub multistrat/ cupru de compresie

Disponibil si in varianta staniu

Cod	Dimensiune	Pret €	Ambalare
165 1026	16 x 2,0 - Ø 14		10/100
165 0120	16 x 2,0 - Ø 15		10/100
165 1027	16 x 2,0 - Ø 16		10/100
165 1574	16 x 2,0 - Ø 18		25/100
165 0164	20 x 2,0 - Ø 22		10/100
165 0236	26 x 3,0 - Ø 22		5/25
165 0335	26 x 3,0 - Ø 28		5/25

Noutati

**1674**

Reductie pentru teava multistrat/piesa de sudura cupru

Cod	Dimensiune	Pret €	Ambalare
165 0270	16 x 2,0 - Ø 15		10/250

**1651CY**

Racord drept tub multistrat/ piesa de sudura cupru

Disponibil si in varianta staniu

Cod	Dimensiune	Pret €	Ambalare
165 0347	16 x Ø 12		10/100
165 0317	16 x Ø 15		10/100
165 0334	20 x Ø 15		10/100
165 0313	20 x Ø 22		10/100
165 0340	26 x Ø 22		10/100
165 0345	26 x Ø 28		10/100
165 1476	32 x Ø 28		10/100

**1654**

Cot M

Disponibil si in varianta staniu

Cod	Dimensiune	Pret €	Ambalare
165 1047	16 x 3/8"		10/100
165 0010	16 x 1/2"		10/100
165 0029	20 x 1/2"		10/100
165 0044	20 x 3/4"		10/50
165 0280	25 x 3/4"		5/50
165 0046	26 x 3/4"		5/50
165 1036	26 x 1"		5/50
165 0074	32 x 1"		5/25
165 0152	40 x 1"1/4		5/25
165 0185	50 x 1"1/2		1/8
165 0203	63 x 2"		1/8

**1655**

Cot F

Disponibil si in varianta staniu

Cod	Dimensiune	Pret €	Ambalare
165 0001	16 x 1/2"		10/100
165 0012	20 x 1/2"		10/100
165 0035	20 x 3/4"		10/50
165 0210	25 x 3/4"		5/25
165 1013	25 x 1"		5/25
165 0023	26 x 3/4"		5/25
165 0080	26 x 1"		5/25
165 0057	32 x 1"		5/25
165 0114	40 x 1"1/4		5/25
165 0163	50 x 1"1/2		1/8



1653
Cot dublu

i Disponibil si in varianta staniu

Cod	Dimensiune	Pret €	Ambalare
165 0011	16 x 16		10/100
165 0348	20 x 16		10/100
165 0006	20 x 20		10/100
165 0140	25 x 25		5/25
165 0003	26 x 26		5/25
165 0013	32 x 32		5/25
165 0036	40 x 40		5/25
165 0043	50 x 50		1/10
165 0056	63 x 63		1/8
165 1118	75 x 75		1/2
165 1253	90 x 90		1/1

La cerere



1661
Curba la 45°

i Disponibil si in varianta staniu

Cod	Dimensiune	Pret €	Ambalare
165 0197	26 x 26		5/25
165 0176	32 x 32		5/25
165 0124	40 x 40		5/25
165 0144	50 x 50		1/10
165 0172	63 x 63		1/5
165 1117	75 x 75		1/4
165 1264	90 x 90		1/1

La cerere



1669
Cot M cu conector cu piulita

i Disponibil si in varianta staniu

Cod	Dimensiune	Pret €	Ambalare
165 0246	26 x 1"		5/25



1660BP
Racord cot cu piulita si garnitura plata

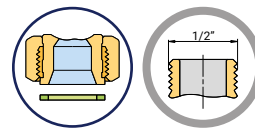

i Disponibil si in varianta staniu

Cod	Dimensiune	Pret €	Ambalare
165 1042	16 x 3/8"		5/100
165 0352	16 x 1/2"		5/100
165 0179	16 x 3/4"		5/100
165 1033	20 x 1/2"		5/100
165 0178	20 x 3/4"		5/100
165 1413	20 x 1"		5/50
165 1035	25 x 3/4"		5/50
165 0274	26 x 3/4"		5/50
165 1034	26 x 1"		5/50
165 1043	32 x 1"		5/25
165 1048	32 x 1"1/4		5/25

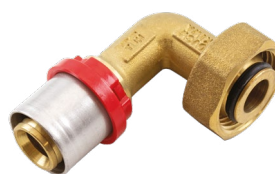

1660
Racord cot cu conectare cu piulita pentru conexiuni 3/4"x18 Eurocono

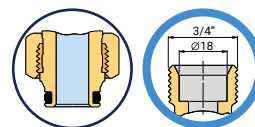

Cod	Dimensiune	Pret €	Ambalare
165 0182	16 x 3/4" (ø18)		5/100
165 0173	20 x 3/4" (ø18)		5/100



1653KB
Cot dublu tub multistrat/cupru de compresie

i Disponibil si in varianta staniu

Cod	Dimensiune	Pret €	Ambalare
165 0283	16 x 2,0 - Ø 15		10/100
165 0284	20 x 2,0 - Ø 22		10/100
165 0324	26 x 3,0 - Ø 22		5/25



LISTA DE PREȚURI



1658
Teu M

i Disponibil si in varianta staniu

Cod	Dimensiune	Pret €	Ambalare
165 0085	16 x 1/2" x 16		10/100
165 0092	20 x 1/2" x 20		5/100
165 0131	20 x 3/4" x 20		5/50
165 0149	26 x 1/2" x 26		5/25
165 0098	26 x 3/4" x 26		5/25
165 0167	26 x 1" x 26		5/25
165 0657	32 x 3/4" x 32		5/25
165 0155	32 x 1" x 32		5/25
165 0209	40 x 1"1/4 x 40		1/20



1659
Teu F

i Disponibil si in varianta staniu

Cod	Dimensiune	Pret €	Ambalare
165 0031	16 x 1/2" x 16		10/100
165 0039	20 x 1/2" x 20		5/50
165 0079	20 x 3/4" x 20		5/50
165 0833	25 x 1/2" x 25		5/25
165 0261	25 x 3/4" x 25		5/25
165 0105	26 x 1/2" x 26		5/25
165 0048	26 x 3/4" x 26		5/25
165 0142	32 x 1/2" x 32		5/25
165 0125	32 x 3/4" x 32		5/25
165 0054	32 x 1" x 32		5/25
165 1128	40 x 3/4" x 40		1/20
165 0118	40 x 1" x 40		1/20
165 0112	40 x 1"1/4 x 40		1/20
165 0130	50 x 3/4" x 50		1/10
165 0146	50 x 1" x 50		1/10
165 0162	63 x 1" x 63		1/5
165 1248	63 x 1"1/2 x 63		1/5
165 1122	75 x 1"1/4 x 75		1/5
165 1255	90 x 1" x 90		1/1
165 1268	90 x 1"1/4 x 90		1/1

La cerere



1657
Teu

i Disponibil si in varianta staniu

Cod	Dimensiune			Pret €	Ambalare
	1	2	3		
165 0002	16	16	16		10/50
165 0005	20	20	20		5/50
165 0181	25	25	25		5/25
165 0018	26	26	26		5/25
165 0058	32	32	32		5/25
165 0083	40	40	40		1/20
165 0108	50	50	50		1/10
165 0109	63	63	63		1/5
165 1114	75	75	75		1/5
165 1265	90	90	90		1/1
Redus					
165 0070	16	20	16		5/50
165 0350	16	25	16		5/25
165 0351	16	26	16		5/25
165 0019	20	16	16		5/50
165 0008	20	16	20		5/50
165 0045	20	20	16		5/50
165 0825	20	25	20		5/25
165 0069	20	26	20		5/25
165 0290	25	16	16		5/25
165 0821	25	16	20		5/25
165 0220	25	16	25		5/25
165 0826	25	20	16		5/25
165 0213	25	20	20		5/25
165 0201	25	20	25		5/25
165 0321	25	25	16		5/25
165 0244	25	25	20		5/25
165 0822	25	32	25		5/25
165 0102	26	16	16		5/25
165 0078	26	16	20		5/25
165 0026	26	16	26		5/25
165 0132	26	20	16		5/25
165 0047	26	20	20		5/25
165 0017	26	20	26		5/25
165 0127	26	26	16		5/25
165 0063	26	26	20		5/25
165 0165	26	32	26		5/25
165 0073	32	16	32		5/25
165 0156	32	20	20		5/25
165 0827	32	20	25		5/25

1657 - Racord teu, redus

Cod	Dimensiune			Pret €	Ambalare
	1	2	3		
165 0136	32	x 20	x 26		5/25
165 0055	32	x 20	x 32		5/25
165 1037	32	x 25	x 20		5/25
165 0823	32	x 25	x 25		5/25
165 0828	32	x 25	x 32		5/25
165 0075	32	x 26	x 26		5/25
165 0064	32	x 26	x 32		5/25
165 0143	32	x 32	x 20		5/25
165 0824	32	x 32	x 25		5/25
165 0119	32	x 32	x 26		5/25
165 0199	32	x 40	x 32		1/20
165 0195	40	x 16	x 40		1/20
165 0096	40	x 20	x 40		1/20
165 0829	40	x 25	x 40		1/20
165 0081	40	x 26	x 40		1/20
165 0128	40	x 32	x 32		1/20
165 0095	40	x 32	x 40		1/20
165 0830	40	x 40	x 25		1/20
165 0222	40	x 40	x 26		1/20
165 0192	40	x 40	x 32		1/20
165 0259	40	x 50	x 40		1/10
165 0308	50	x 16	x 50		1/10
165 0168	50	x 20	x 50		1/10
165 0831	50	x 25	x 50		1/10
165 0117	50	x 26	x 50		1/10
165 0123	50	x 32	x 50		1/10
165 0196	50	x 40	x 40		1/10
165 0148	50	x 40	x 50		1/10
165 0230	50	x 50	x 32		1/10
165 0224	50	x 50	x 40		1/10
165 1406	63	x 20	x 63		1/5
165 0832	63	x 25	x 63		1/5
165 0086	63	x 26	x 63		1/5
165 0129	63	x 32	x 63		1/5
165 0147	63	x 40	x 63		1/5
165 0166	63	x 50	x 63		1/5
165 1407	75	x 40	x 75		1/5
165 1116	75	x 50	x 75		1/5
165 1408	75	x 63	x 63		1/5
165 1115	75	x 63	x 75		1/5
165 1266	90	x 63	x 90		1/1
165 1267	90	x 75	x 90		1/1

La cerere

**1687**

Cruce

 Disponibil si in varianta staniu

Cod	Dimensiune	Pret €	Ambalare
165 0307	20 x 16 x 20 x 16		5/25
165 0331	20 x 20 x 16 x 16		5/25
165 0320	20 x 20 x 20 x 20		5/25
165 0378	25 x 16 x 20 x 16		5/20
165 0289	25 x 20 x 16 x 16		5/20
165 0379	25 x 20 x 20 x 20		5/20
165 0380	26 x 16 x 20 x 16		5/20
165 0322	26 x 20 x 16 x 16		5/20
165 0327	26 x 20 x 20 x 20		5/20

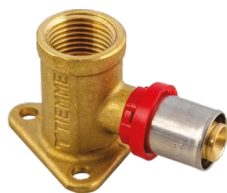

LISTA DE PREȚURI

**1656SM**

Cot F cu flansa cu 3 gauri de prindere, cu gat scurt

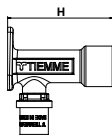

i Disponibil si in varianta staniu

Cod	Dimensiune	H	Pret €	Ambalare
165 0021	16 x 1/2"	40 mm		10/50
165 0088	20 x 1/2"	40 mm		5/50

**1656**

Cot F cu flansa cu 3 gauri de prindere

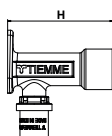

i Disponibil si in varianta staniu

Cod	Dimensiune	H	Pret €	Ambalare
165 0004	16 x 1/2"	52 mm		10/50
165 1044	16 x 3/4"	52 mm		10/50
165 0038	20 x 1/2"	52 mm		5/50
165 1045	20 x 3/4"	52 mm		5/50
165 1049	26 x 3/4"	52 mm		5/50

**1656ISOL01**

Izolatie acustica
Se foloseste impreuna cu Art. 1656

+ **IZOLARE FONICA PENTRU RACORDURI CU FLANSA**
Seturile de izolare acustica permit reducerea la minim a zgomotului din sistem garantand un confort maxim si in prezenta peretilor subtiri sau a celor din gips carton conform cu normativa DIN 4109.

Cod	Dimensiune	Pret €	Ambalare
165 0305	1/2"		10/50

**1656CE**

Cot F cu flansa cu 3 gauri de prindere

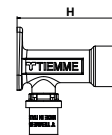

i Disponibil si in varianta staniu

Cod	Dimensiune	H	Pret €	Ambalare
165 1021	16 x 1/2"	52 mm		10/50
165 1022	20 x 1/2"	52 mm		5/50

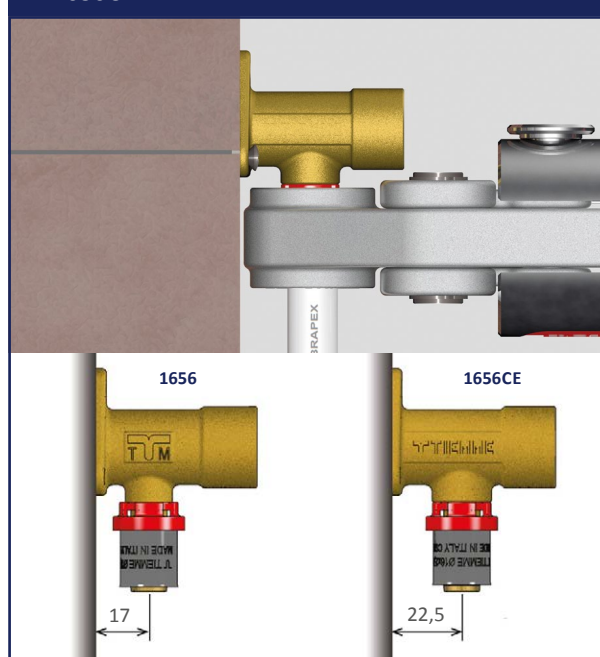
1656CE EXEMPLU DE UTILIZARE**1656XL**

Cot F cu flansa cu 3 gauri de prindere

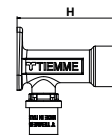

i Disponibil si in varianta staniu

Cod	Dimensiune	H	Pret €	Ambalare
165 0097	16 x 1/2"	77 mm		5/50
165 1192	16 x 1/2"	90 mm		5/50
165 1182	16 x 1/2"	110 mm		5/50

**1680XL**

Cot M cu flansa cu 3 gauri de prindere, cu gat lung.

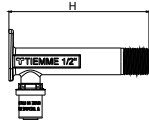

Cod	Dimensiune	H	Pret €	Ambalare
165 1189	16 x 1/2"	70 mm		5/50
165 1186	16 x 1/2"	90 mm		5/50
165 1107	16 x 1/2"	110 mm		5/50

**1656ISOL02**

Izolatie acustica

Se foloseste impreuna cu 1656XL

**IZOLARE FONICA PENTRU RACORDURI CU FLANSA**

Seturile de izolare acustica permit reducerea la minim a zgomotului din sistem garantand un confort maxim si in prezenta peretilor subtiri sau a celor din gips carton conform cu normativa DIN 4109.

Cod	Dimensiune	Pret €	Ambalare
165 0344	1/2" - 77 mm		10/50

**1656ISOL01
1656ISOL02**

EXEMPLU DE UTILIZARE

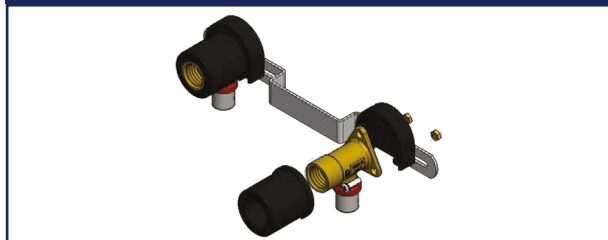
**1656KB**

Cot cu flansa pentru tub multistrat/teava de cupru

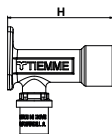

Disponibil si in varianta staniu

Cod	Dimensiune	H	Pret €	Ambalare
165 0306	16 x 15	52 mm		10/50
165 0343	20 x 15	52 mm		5/50

**1663FL**

Racord dublu decalat cu flansa

Cod	Dimensiune	Pret €	Ambalare
165 1566	16 x 1/2" x 16		10/50
165 1567	20 x 1/2" x 20		5/50

**1664FLDX**

Racord terminal decalat dreapta cu flansa

Cod	Dimensiune	Pret €	Ambalare
165 1568	16 x 1/2"		10/50
165 1569	20 x 1/2"		5/50

**1664FLSX**

Racord terminal decalat stanga cu flansa

Cod	Dimensiune	Pret €	Ambalare
165 1570	16 x 1/2"		10/50
165 1571	20 x 1/2"		5/50

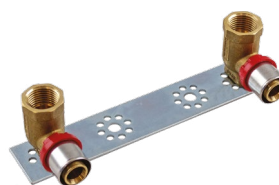
**1664**

Consola cu racorduri finale



Disponibil si in varianta staniu



Interaxe variabile: 100 - 110 - 150 mm

Cod	Dimensiune	Pret €	Ambalare
165 0024	16 x 1/2"		1/40
165 1309	16 x 3/4"		1/20
165 0106	20 x 1/2"		1/20
165 1310	20 x 3/4"		1/20

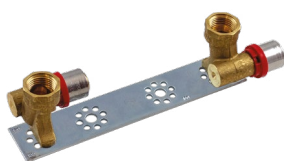

**1664DI**

Consola cu racorduri finale nealiniate

i Disponibil si in varianta staniu

i Interaxe variabile: 100 - 110 - 150 mm

Cod	Dimensiune	Pret €	Ambalare
165 0151	16 x 1/2"		1/10
165 0227	20 x 1/2"		1/10

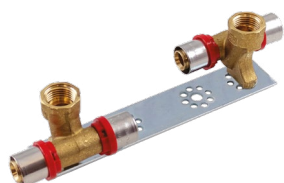
**1663DI**

Consola cu racorduri nealiniate pentru conectare in serie

i Disponibil si in varianta staniu

i Interaxe variabile: 100 - 110 - 150 mm

Cod	Dimensiune	Pret €	Ambalare
165 0082	16 x 1/2"		1/10
165 0137	20 x 1/2"		1/10

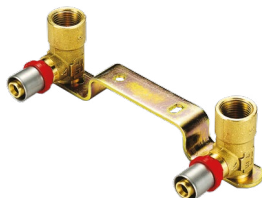
**1678**

Consola cu racorduri

i Disponibil si in varianta staniu

Cod	Dimensiune	Pret €	Ambalare
165 0319	16x3/8" Int. 120 mm H = 37		1/25

Pina la terminarea stocului

**1679KB**

Consola cu racorduri pentru tub multistrat Ø16x2,0/teava de cupru Ø15

i Disponibil si in varianta staniu

Cod	Dimensiune	H	Pret €	Ambalare
165 0287	Int. 35	53 mm		1/25
165 0375	Int. 35	65 mm		1/25
165 0376	Int. 38	53 mm		1/25
165 0377	Int. 38	65 mm		1/25
165 0285	Int. 50	53 mm		1/25
165 0329	Int. 50	65 mm		1/25

**1675**

Teu By-pass

Cod	Dimensiune	Pret €	Ambalare
165 0205	16 x 16 x 16		5/15
165 0183	20 x 16 x 16		5/15
165 0157	20 x 16 x 20		5/15
165 0174	20 x 20 x 20		5/15

**1675ISOL**

Izolatie pentru Art. 1675

Cod	Dimensiune	Pret €	Ambalare
159 0045	unica		1/30

EXEMPLU DE INSTALARE

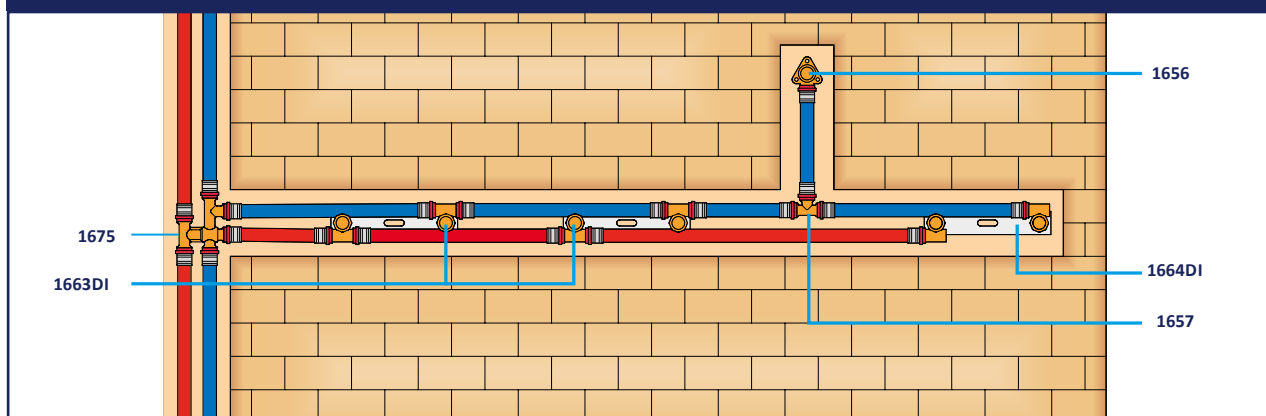

**1676SM**

Cot dublu F cu flansa cu gat scurt

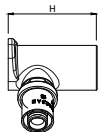

i Disponibil si in varianta staniu

Cod	Dimensiune	H	Pret €	Ambalare
165 0215	16 x 1/2"	40 mm		10/50
165 0267	20 x 1/2"	40 mm		5/50

**1676**

Cot dublu F cu flansa

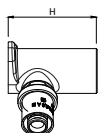

i Disponibil si in varianta staniu

Cod	Dimensiune	H	Pret €	Ambalare
165 0111	16 x 1/2" x 16	52 mm		10/50
165 0171	20 x 1/2" x 20	52 mm		5/50

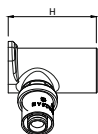
**1676KB**Cot dublu pentru tub multistrat/
teava de cupru

i Disponibil si in varianta staniu

Cod	Dimensiune	H	Pret €	Ambalare
165 0372	16 x 15 x 16	52 mm		10/50
165 0326	20 x 15 x 20	52 mm		5/50

**1676USM**

Cot dublu F cu flansa "U" cu gat scurt.

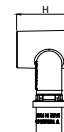

+ ANTI - LEGIONELA

i Disponibil si in varianta staniu

Cod	Dimensiune	H	Pret €	Ambalare
165 1315	16 x 1/2" x 16	40 mm		5/50
165 1317	20 x 1/2" x 20	40 mm		5/50

**1654U**

Cot dublu M "U"

+ ANTI - LEGIONELA

i Disponibil si in varianta staniu

Cod	Dimensiune	Pret €	Ambalare
165 1402	16 x 1/2" x 16		5/50
165 1403	20 x 1/2" x 20		5/50

**1676USM
1654U**

EXEMPLU DE UTILIZARE

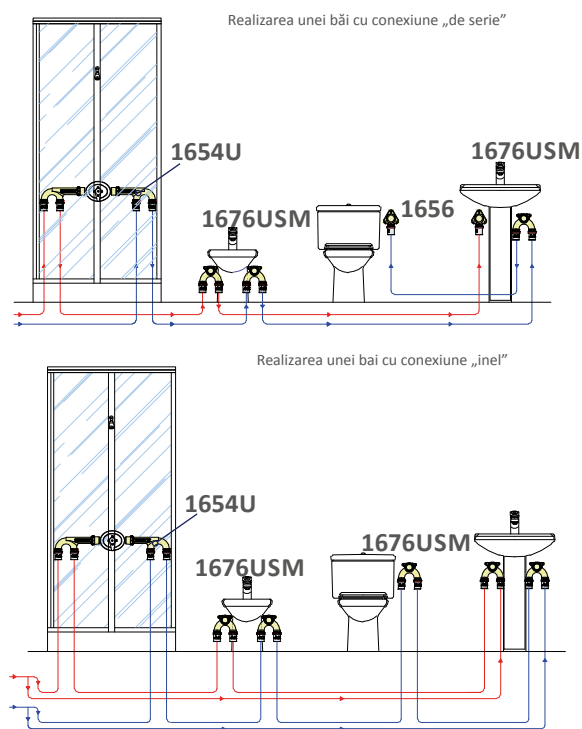

LISTA DE PREȚURI

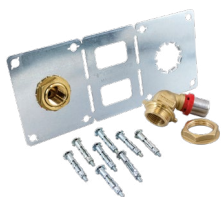
**1664CG**

Consola cu racorduri 105° finale COBRAFIX pentru peretii din ghips sp. 13 mm

BREVETAT

Interaxe: 150 mm

Cod	Dimensiune	Pret €	Ambalare
165 1060	16 x 1/2"		1/5
165 1271	20 x 1/2"		1/5

**1664CG55**

Consola cu racorduri 105° finale COBRAFIX pentru peretii din ghips sp. 13 mm

BREVETAT

Interaxe: 55 mm

Cod	Dimensiune	Pret €	Ambalare
165 1236	16 x 1/2"		1/5
165 1272	20 x 1/2"		1/5

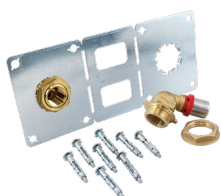
**1664CGXL**

Consola cu racorduri 105° finale COBRAFIX pentru peretii din ghips sp. 20 mm

BREVETAT

Interaxe: 150 mm

Cod	Dimensiune	Pret €	Ambalare
165 1311	16 x 1/2"		1/5
165 1313	20 x 1/2"		1/5

**1664CG55XL**

Consola cu racorduri 105° finale COBRAFIX pentru peretii din ghips sp. 20 mm

BREVETAT

Interaxe: 55 mm

Cod	Dimensiune	Pret €	Ambalare
165 1312	16 x 1/2"		1/5
165 1314	20 x 1/2"		1/5

1664CG
1664CGXL SECTIUNE

1664CG



Max. 13

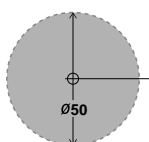

Ø50

1664CGXL

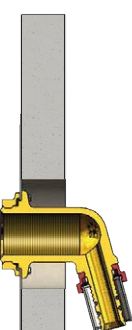

Max. 20

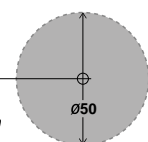

Ø50

150 mm

1664CG55
1664CG55XL SECTIUNE

1664CG55

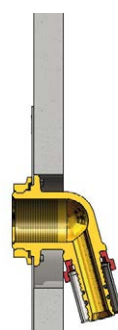

Max. 13

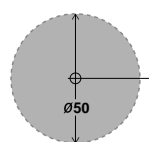

Ø50

1664CG55XL

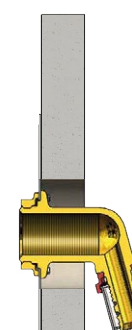

Max. 20

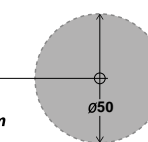

Ø50

55 mm

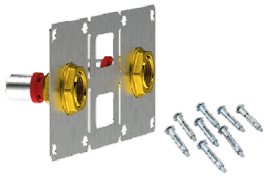
**1652CG**

Consola cu racorduri drepte
finale COBRAFIX pentru peretii
din ghips

 BREVETAT

 Interaxe: 150 mm

Cod	Dimensiune	Pret €	Ambalare
165 1414	16 x 1/2"		1/5

1652CG

SECTIUNE

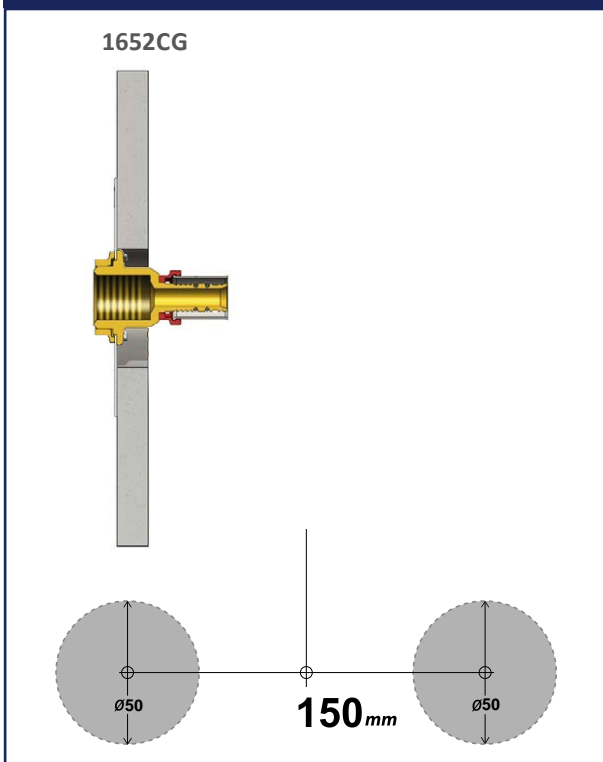
1664CG - 1664CGXL - 1664CG55 - 1664CG55XL - 1652CG
 INSTRUȚIUNI DE ASAMBLARE

**1662**

Racord cu flansa pentru vas WC ingropat

i Disponibil si in varianta staniu

Cod	Dimensiune	Pret €	Ambalare
165 0175	16 x 1/2"		10/50
165 0260	20 x 1/2"		5/25

**1662CG**

Racord curbat cu flansa prin perete pentru pereți din rigips

Cod	Dimensiune	Pret €	Ambalare
165 1062	16 x 1/2" L=28		1/50

**1662LG**

Racord curbat cu flansa prin perete pentru pereți din lemn

Cod	Dimensiune	Pret €	Ambalare
165 1063	16 x 1/2" L=28		1/50



1688
Colector 5 cai

 Disponibil si in varianta staniu

Cod	Dimensiune					Pret €	Ambalare
	1	2	3	4	5		
165 0784	20	20	16	16	16		5/20
165 0785	20	20	20	20	20		5/20
165 0786	25	20	16	16	16		5/20
165 0819	25	20	20	20	20		5/20
165 0787	26	20	16	16	16		5/20
165 0788	26	20	20	20	20		5/20



1672
Cot terminal pentru radiatoare

Cod	Dimensiune	Pret €	Ambalare
Teava de cupru Ø 15 L = 200			
165 0099	16		5/50
Teava de cupru Ø 15 L = 300			
165 0066	16		5/50
165 0194	20		5/50
Teava de cupru Ø 15 L = 1100			
165 0223	16		5/500
165 0312	20		5/500
Teava de cupru Ø 14 L = 300			
165 0138	16		5/50



1672CY
Cot terminal pentru radiatoare

Cod	Dimensiune	Pret €	Ambalare
Teava de cupru Ø 15 L = 160			
165 1028	16		5/50



1673
Teu pentru radiatoare

Cod	Dimensiune	Pret €	Ambalare
Teava de cupru Ø 15 L = 300			
165 0266	16		5/40
165 0229	20		5/40
Teava de cupru Ø 15 L = 1100			
165 0332	16		5/500
165 0293	20		5/500



LISTA DE PRETURI

**1859**

Adaptor pt a transforma un filet EUROCON 3/4x18 in filet cu fata plana

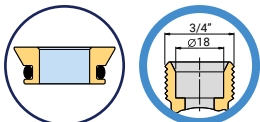

i Disponibil si in varianta staniu

Cod	Dimensiune	Pret €	Ambalare
144 0104	3/4" (ø18)		10/400

**1677**

Racord de capat

i Disponibil si in varianta staniu

Cod	Dimensiune	Pret €	Ambalare
165 0208	16		10/100
165 0216	20		10/100
165 0282	26		5/50
165 0310	32		5/50
165 0315	40		5/25

RACORDURI MULTI-PRESS PANA LA Ø 32

Fitingurile Tiemme sunt proiectate și testate pentru a fi presate cu 6 profile diferite: personalizat TH TIEMME - TH - U - H - B - RF

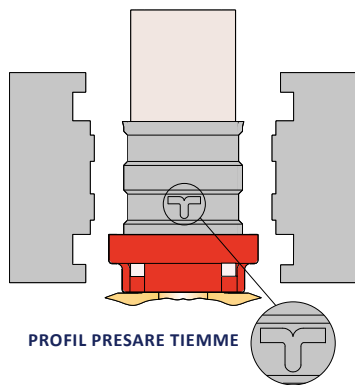

PROFIL PRESARE TIEMME

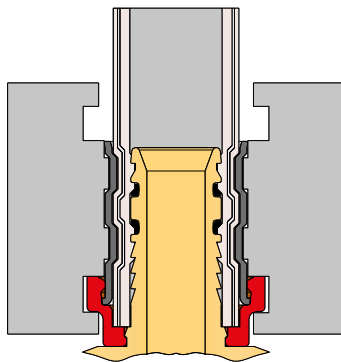

PROFIL PRESARE TIEMME-TH

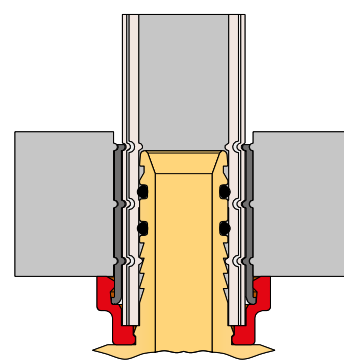

PROFIL PRESARE U

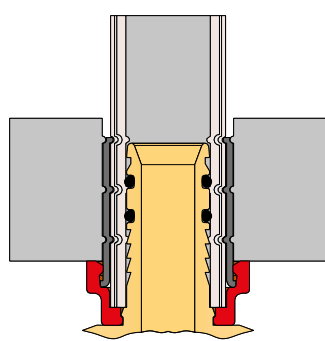

PROFIL PRESARE H

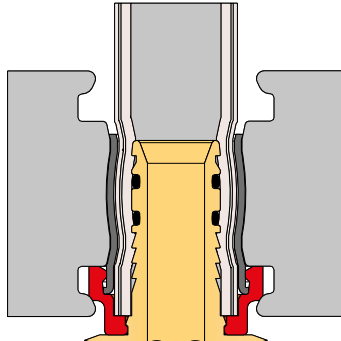

PROFIL PRESARE B

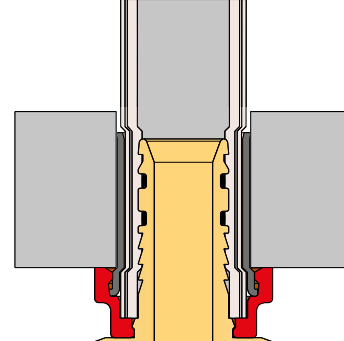

PROFIL PRESARE RF

**1493Z**

Consola pentru art.1656

i Poate fi folosit cu dimensiuni de la Ø 14 și Ø 16 (Ø 20 numai pentru 1656CE)

Cod	Dimensiune	Pret €	Ambalare
159 0016	unica		1/100

1493Z

EXEMPLU DE UTILIZARE

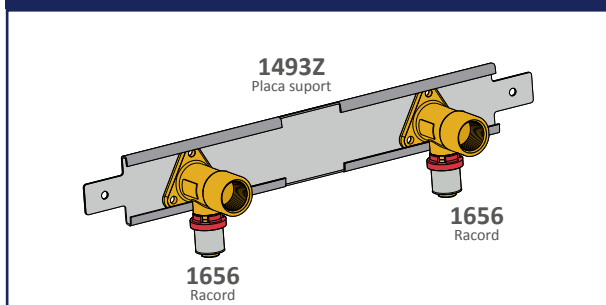
**1481**

Placa pentru cot cu flansa

Cod	Dimensiune	Pret €	Ambalare
147 0005	unica		1/100

1481

EXEMPLU DE UTILIZARE

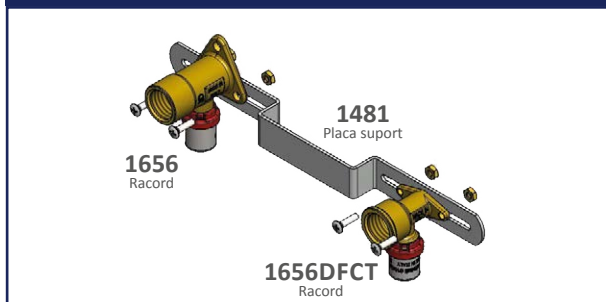
**1670X**

Manson Cobrapress din Inox

i Disponibil si cu inele de plastic albe (1670B)

Cod	Dimensiune	Pret €	Ambalare
165 0184	16		10/350
165 0189	20		10/300
165 0295	25		10/200
165 0187	26		10/200
165 0238	32		10/150
165 0281	40		10/100
165 0291	50		1/50
165 0298	63		1/30
165 1108	75		1/20
165 1269	90		1/1

La cerere

**H9300**

O-ring

Cod	Dimensiune	Pret €	Ambalare
040 0100	16		250/1500
040 0101	20		250/1500
040 0128	25		50/1000
040 0102	26		250/1500
040 0129	32		50/1000
040 0104	40		100/1000
040 0105	50		10/1000
040 0106	63		10/1000



**1697**

Robinet drept cu maneta tip fluture de culoare rosie si piulita

Cod	Dimensiune	Pret €	Ambalare
168 0021	20 x 3/4"		20/80
168 0035	25 x 3/4"		20/80
168 0030	26 x 3/4"		20/80
168 0032	32 x 1"		10/40

**1697CK**

Robinet drept cu maneta tip fluture de culoare rosie, piulita si supapa de sens



i ↗ Directie flux

Cod	Dimensiune	Pret €	Ambalare
168 0029	20 x 3/4"		20/80
168 0027	25 x 3/4"		20/80
168 0036	26 x 3/4"		20/80
168 0037	32 x 1"		10/40

**1691**

Robinet cu sfera cu maneta tip fluture

Cod	Dimensiune	Pret €	Ambalare
168 0010	16 x 16		5/50
168 0007	20 x 20		5/50
168 0025	25 x 25		5/50
168 0008	26 x 26		5/50
168 0087	32 x 32		5/30

**1692**

Robinet de colt cu maneta tip fluture de culoare rosie si piulita

i Disponibil cu maneta tip fluture albastra

Cod	Dimensiune	Pret €	Ambalare
maneta tip fluture rosie			
168 0077	16 x 3/4"		10/40
168 0019	20 x 3/4"		10/40
168 0028	25 x 3/4"		10/40
168 0020	26 x 3/4"		10/40
168 0034	32 x 1"		10/40

**1692CK**

Robinet de colt cu maneta tip fluture de culoare rosie, piulita si supapa de sens



i ↗ Directie flux

Cod	Dimensiune	Pret €	Ambalare
168 0026	20 x 3/4"		10/40
168 0018	25 x 3/4"		10/40
168 0031	26 x 3/4"		10/40
168 0022	32 x 1"		10/40

**1690**

Robinet cu sfera de incastat



Cod	Dimensiune	Pret €	Ambalare
168 0002	16 x 16		5/50
168 0001	20 x 20		5/50
168 0009	25 x 25		5/50
168 0003	26 x 26		5/50

**1690U**

Robinet cu sfera de incastat "U"



Cod	Dimensiune	Pret €	Ambalare
168 0013	16 x 16		1/25
168 0011	20 x 20		1/25
168 0016	25 x 25		1/25
168 0033	26 x 26		1/25

**1696**Robinet cu obertein de incastat
2 cai

Cod	Dimensiune	Pret €	Ambalare
168 0012	16 x 16		5/50
168 0014	20 x 20		5/50
168 0024	25 x 25		5/50
168 0023	26 x 26		5/50

**1690 - 1690U
1696**

CONFIGURATII

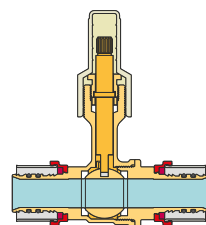

1690

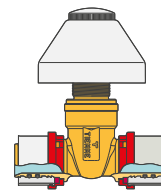
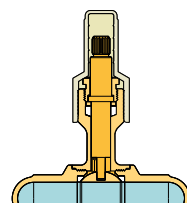
CU
2960SET

1690U

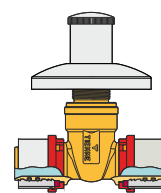
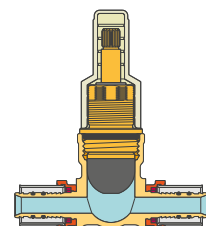
CU
2971SET

1696

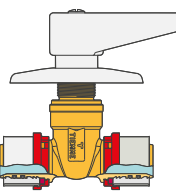
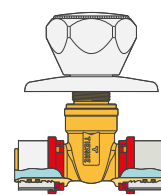
CU
2961SETCU
2963SET

**2960SET**

Set format din capac si rozeta pentru robinetii de incastat art. 2960, 1690, 1690U, 1696, 1740, 1740U si 1746

Cod	Dimensiune	Pret €	Ambalare
295 0006	-		1/25

**2963SET**

Set maneta si rozeta decorativa pentru robinetii de incastat art. 2960, 1690, 1690U, 1696, 1740, 1740U si 1746

Cod	Dimensiune	Pret €	Ambalare
295 0014	-		1/25

**2971SET**

Set format din capac si rozeta pentru robinetii de incastat Art. 2960, 1690, 1690U, 1696, 1740, 1740U si 1746

Cod	Dimensiune	Pret €	Ambalare
295 0167	-		1/25

**2960PR**

Set de prelungire pentru robinetii de incastat art. 2960, 1690, 1690U, 1696, 1740, 1740U si 1746

Cod	Dimensiune	Pret €	Ambalare
295 0015	-		1/100

**2961SET**

Set maneta si rozeta decorativa pentru robinetii de incastat art. 2960, 1690, 1690U, 1696, 1740, 1740U si 1746

Cod	Dimensiune	Pret €	Ambalare
295 0009	-		1/25

**1693**

Robinet cu 3 cai – versiunea de incastat

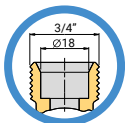

BREVETAT

Cod	Dimensiune	Pret €	Ambalare
168 0005	20 x 16 - 3/4" (Ø18)		1/20
168 0006	20 x 20 - 3/4" (Ø18)		1/20
168 0015	26 x 20 - 3/4" (Ø18)		1/20

**1493SET**

Placa de fixare cu suruburi

Interaxe variabile: 100 - 110 - 150 mm

Cod	Dimensiune	Pret €	Ambalare
159 0034	unica		1/50

**1660**

Cot cu conectare cu piulita pentru conexiuni 3/4"x18 (Eurocono)

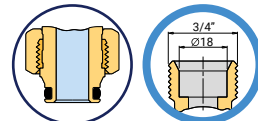

Cod	Dimensiune	Pret €	Ambalare
165 0182	16 x 3/4" (Ø18)		5/100
165 0173	20 x 3/4" (Ø18)		5/100

**1879**

Racord terminal cu conexiuni 3/4"x18 (EUROCONO)

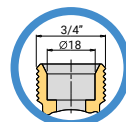

Cod	Dimensiune	Pret €	Ambalare
144 0071	3/4" (Ø18)		10/250

**1693PR**

Set prelungitor pentru robineti îngropați 1693

Cod	Dimensiune	Pret €	Ambalare
295 0111	-		1/100

1693

EXEMPLU DE INSTALARE: CONSUMATORI IZOLATI SAU PE PARTEA OPUSA

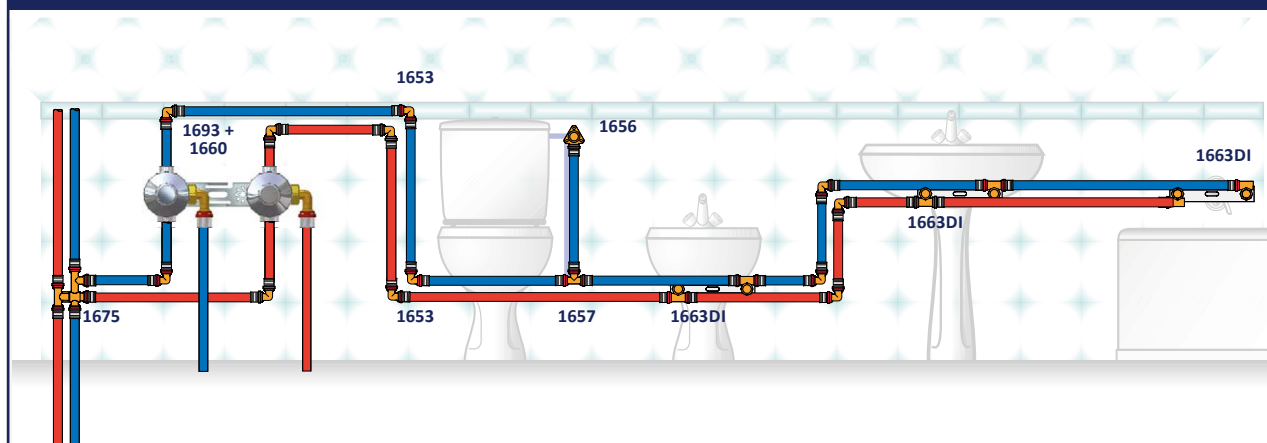

LISTA DE PRETURI

INSTRUCIUNI DE MONTAJ - SERIA 1650

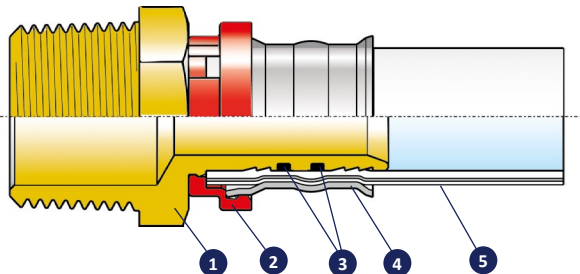

- 1 Corpul racordului din alama
- 2 Inel din plastic, permite sa se vada daca tubul a fost bine introdus in racord si izoleaza dielectric tubul fata de corpul racordului
- 3 Garnituri O-ring din EPDM calitate alimentara
- 4 Manson de sertizare din oțel inox AISI 304
- 5 "AL-COBRAPEX" tub multistrat

Fitingurile de presare se caracterizează prin sistemul de etanșare care se formează prin deformarea mecanică a mansonului exterior din oțel inoxidabil. Această deformare se realizează cu ajutorul unui instrument special echipat cu clești de oțel corespunzător; Procedând astfel, puteți fi sigur că presiunea de strângere rămâne întotdeauna aceeași și la un nivel optim pentru toate fittingurile, sporind fiabilitatea îmbinărilor. Fitingurile de presare Tiemme se caracterizează și prin prezența unui inel de plastic care realizează trei funcții foarte importante. Prima, deoarece este un material plastic, este funcția sa dielectrică, adică nu permite stratului interior de aluminiu al tubului să intre în contact cu corpul fittingului (din alamă) declanșând evitând astfel un posibil efect de pila. A doua funcție, de asemenea de importanță fundamentală, este aceea care permite instalatorului să verifice vizual și ușor dacă și când conducta este introdusă corect în fitting. A treia funcție facilitează poziționarea corectă în interiorul capului de presare Tiemme, aceasta posibilitate de verificare simplă și imediată, garantează o siguranță de instalare față de alte tipuri de fittinguri.

Pentru a obține o îmbinare perfectă trebuie efectuate câteva operații simple, dar importante.

1. TĂIEREA TUBULUI

Mai întâi trebuie să tăiați tubul la dimensiunea dorită. Pentru a efectua tăierea este indicat să folosiți un tăietor de țevi sau foarfeca adecvată, asigurându-vă că tăierea este cât mai perpendiculară pe axa tubului.

2. CALIBRARE ȘI DEBAVURARE

Restabiliți forma tubului folosind calibratorul corespunzător. Acordați o atenție deosebită la efectuarea operațiunii de calibrare și debavurare a țevilor, care urmează să fie efectuate cu sculele adecvate. Orice bavuri reziduale ar putea deteriora o-ring-urile.

3. CONECTAREA TUBULUI LA RACORD

Introduceți tubul în fitting până când ajunge la capăt (verificați prin „fereastra” mansonului inelar).

4. PRESARE

Înainte de a trece la presarea fittingului este necesar să verificați ca mansonul să fie corect asamblat pe locul specific realizat în fittingul din alamă, dacă este cazul este necesară repositionarea mansonului. În cazul instalării subterane cu beton lichid, se recomandă protejarea legăturilor dintre fittinguri și țevă pentru a le izola de eventuale contact cu materialul.

Vă reamintim că profilul fălcilor ce urmează a fi folosit pentru presarea fittingurilor Tiemme trebuie să fie de tip **TH**.

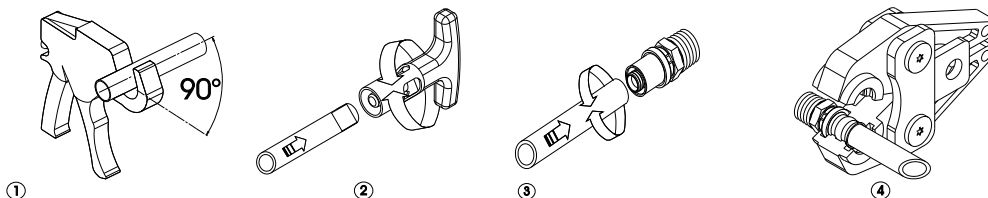

INSTRUCTIUNI PENTRU CORECTA UTILIZARE A PRELUNGITORULUI DE REPARATII 1671

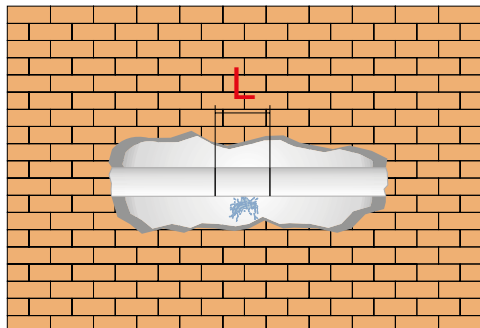

Taiati tubul pe o lungime de aproximativ $L=30\text{mm}$, in vecinatatea zonei unde este avaria. Taietura trebuie sa fie perfect perpendiculara pe axul tubului si pentru a facilita aceasta operatie va sfatuim sa folositi o foarfeca speciala pentru tuburi (vezi 1495 sau 1496)

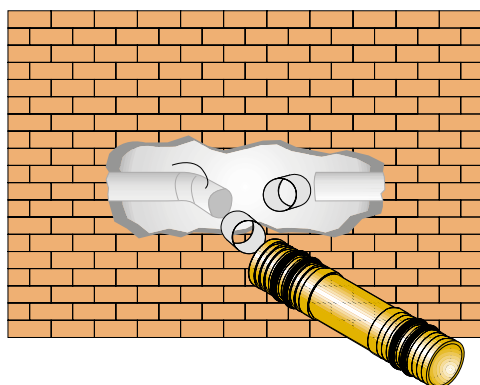

Indoiti unul din capetele tubului taiat pentru a facilita introducerea mansoanelor si a prelungitorului de reparatii (1671)

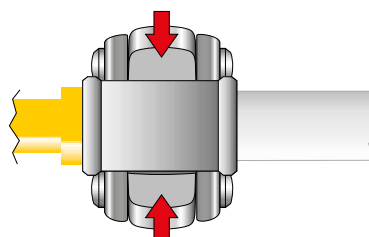
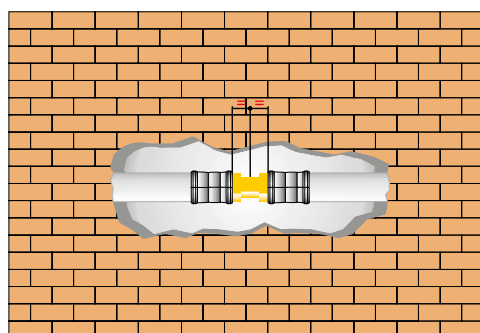

FIG. 1

Intai pozitionati mansoanele in apropierea capetelor taiate ale tubului. Odata introdus si al doilea capat al tubului de reparat pe prelungitorul de reparatii, se trece la presarea mansoanelor (vezi fig.1) tinand de partea centrala a tubului de reparatii astfel incat acesta sa fie in pozitie centrala fata de taietura executata anterior. Pentru presare folositi presa electrica.

04 RACORDURI DE COMPRESIE PENTRU TUB "COBRAPEX"

Seria 1400

Racorduri de compresie pentru tub "COBRAPEX"



100

Accesorii si piese de schimb



105



GHID DE COMPATIBILITATE

Seria	Tub potrivit	Domeniu de aplicare	Caracteristici tehnice
1400	PE-X "COBRAPEX"	• Apa	Tmax: + 95 °C Pmax: 10 bar

Pentru detalii suplimentare consultati fisa tehnica



1400
Racord drept M

Cod	Dimensiune	Grosime	Pret €	Ambalare
140 0226	16 x 3/8"	2,0		10/250
140 0002	16 x 1/2"	2,0		10/250
140 0068	16 x 3/4"	2,0		5/150
140 0035	20 x 1/2"	2,0		5/150
140 0014	20 x 3/4"	2,0		5/150
140 0025	25 x 3/4"	2,3		5/100
140 0047	25 x 1"	2,3		5/100
140 0140	32 x 3/4"	2,9 și 3,0		5/50
140 0012	32 x 1"	2,9 și 3,0		5/50
140 0133	32 x 1"1/4	2,9 și 3,0		5/50

Până la terminarea stocului



1450
Racord drept M pentru tub
Pe-X cu garnitura o-ring pentru
colectoare bara

Cod	Dimensiune	Pret €	Ambalare
140 0239	16 x 2,0		10/250
140 0248	20 x 2,0		5/150



1402
Racord drept F

Cod	Dimensiune	Grosime	Pret €	Ambalare
140 0009	16 x 1/2"	2,0		10/200
140 0109	16 x 3/4"	2,0		5/150
140 0053	20 x 1/2"	2,0		10/150
140 0056	20 x 3/4"	2,0		5/100
140 0073	25 x 3/4"	2,3		5/100
140 0147	25 x 1"	2,3		5/100
140 0209	32 x 3/4"	2,9 și 3,0		1/60
140 0042	32 x 1"	2,9 și 3,0		5/50

Până la terminarea stocului



1401
Racord drept dublu

Cod	Dimensiune	Grosime	Pret €	Ambalare
140 0015	16 x 16	2,0		10/200
140 0043	20 x 20	2,0		5/100
140 0101	25 x 25	2,3		5/100
140 0051	32 x 32	2,9 și 3,0		5/35



1404
Cot M

Cod	Dimensiune	Grosime	Pret €	Ambalare
140 0026	16 x 1/2"	2,0		10/200
140 0124	16 x 3/4"	2,0		5/150
140 0110	20 x 1/2"	2,0		10/100
140 0059	20 x 3/4"	2,0		5/100
140 0062	25 x 3/4"	2,3		5/100
140 0093	25 x 1"	2,3		5/100
140 0098	32 x 1"	2,9 și 3,0		5/35
140 0128	32 x 1"1/4	2,9 și 3,0		5/35





1405
Cot F

Cod	Dimensiune	Grosime	Pret €	Ambalare
140 0006	16 x 1/2"	2,0		10/150
140 0154	16 x 3/4"	2,0		5/100
140 0088	20 x 1/2"	2,0		5/100
140 0060	20 x 3/4"	2,0		5/100
140 0113	25 x 3/4"	2,3		5/50
140 0181	25 x 1"	2,3		5/50
140 0142	32 x 1"	2,9 și 3,0		5/35



1406
Cot F cu flansa cu 3 gauri

Cod	Dimensiune	Grosime	Pret €	Ambalare
140 0023	16 x 1/2"	2,0		10/100



1403
Cot dublu

Cod	Dimensiune	Grosime	Pret €	Ambalare
140 0021	16 x 16	2,0		10/150
140 0079	20 x 20	2,0		5/100
140 0143	25 x 25	2,3		5/50
140 0116	32 x 32	2,9 și 3,0		5/25



1408
Teu M

Cod	Dimensiune	Grosime	Pret €	Ambalare
140 0122	16 x 1/2" x 16	2,0		10/100
140 0203	20 x 3/4" x 20	2,0		5/60
140 0260	25 x 1" x 25	2,3		5/50
140 0193	32 x 1" x 32	2,9 și 3,0		5/20

Până la terminarea stocului



1409
Teu F

Cod	Dimensiune	Grosime	Pret €	Ambalare
140 0020	16 x 1/2" x 16	2,0		10/100
140 0130	20 x 1/2" x 20	2,0		5/50
140 0127	20 x 3/4" x 20	2,0		5/50
140 0152	25 x 3/4" x 25	2,3		5/50
140 0222	32 x 3/4" x 32	2,9 și 3,0		5/20
140 0107	32 x 1" x 32	2,9 și 3,0		5/20



1407
Teu

Cod	Dimensiune	Grosime	Pret €	Ambalare
140 0007	16 x 16 x 16	2,0		10/100
140 0075	20 x 20 x 20	2,0		5/50
140 0145	25 x 25 x 25	2,3		5/35
140 0111	32 x 32 x 32	2,9 și 3,0		5/15



1428MP

Cot 105° F

Interaxa gauri 34mm

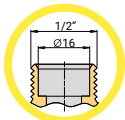

Cod	Dimensiune	Grosime	Pret €	Ambalare
140 0126	1/2" (Ø16)	toate		10/100
140 0001	16 x 1/2"	2,0		10/100
140 0032	20 x 1/2"	2,0		5/100

Racord fara garnitura



1428XL

Cot 105° F lung

Cod	Dimensiune	Grosime	Pret €	Ambalare
140 0087	16 x 1/2"	2,0		10/100

1428XL

GHID DE CONEXIUNI

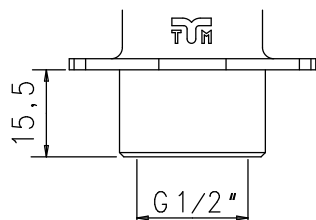

1428MP

GHID DE CONEXIUNI

(COD. 140 0126)

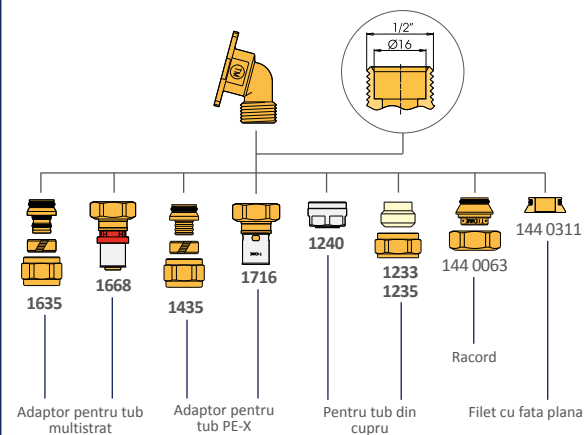

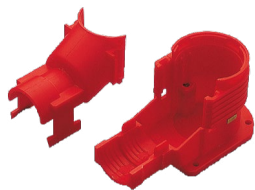
**1490**

Caseta din plastic de utilizat cu 1418 si 1428MP

i înălțime cutie 55 mm

Cod	Dimensiune	Pret €	Ambalare
147 0003	Teaca Ø 23 si Ø 27		1/90

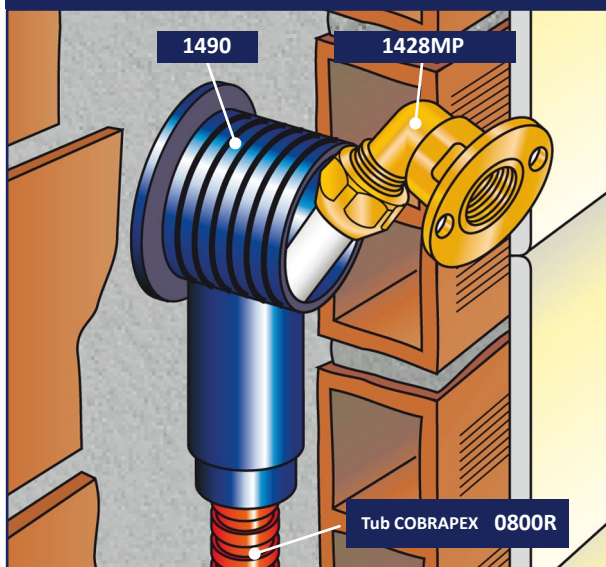
1428MP - 1490 EXEMPLU DE APLICATIE**1490P43**

Caseta din plastic compartimentabila de utilizat cu 1428MP

i înălțime cutie 59 mm

Cod	Dimensiune	Pret €	Ambalare
147 0008	teaca Ø23		1/100
147 0001	Ø27		1/100
147 0029	teaca Ø27 cu șuruburi autofiletante		1/100

**1490KIT01**

Kit caseta din plastic compartimentabila + cot 105° F

Cod	Dimensiune	Pret €	Ambalare
140 0610	16 x 2,0		1/40
140 0613	16 x 2,0 cu șuruburi autofiletante		1/40

**1492MP**

Caseta din plastic pentru pereti subtiri de utilizat cu 1428MP

i înălțime cutie 46 mm

Cod	Dimensiune	Pret €	Ambalare
147 0002	Teaca Ø 23		1/100

**1491**

Placa dubla fractionabila

Cod	Dimensiune	Pret €	Ambalare
147 0004	Unica		1/150

**1420K**

Teu F cu racord 24x19fil (Ø18) de utilizat cu 1420P

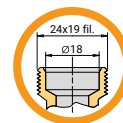

Cod	Dimensiune	Pret €	Ambalare
140 0190	24x19 fil (Ø 18) - 1/2" F		10/100

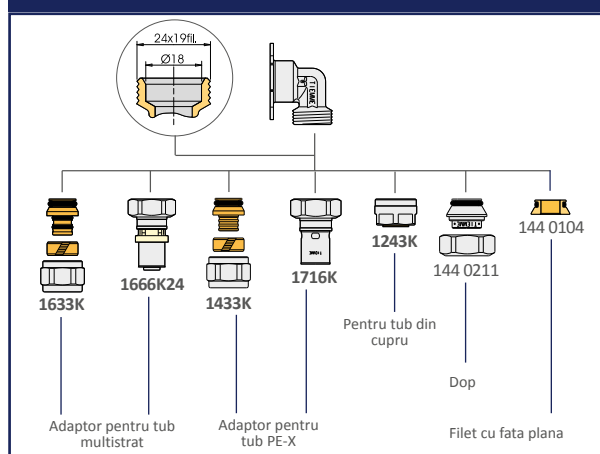
1420K GHID DE CONEXIUNI

**1420K (PEX)**

Teu F cu racord pentru teava Pex de utilizat cu 1420P

Cod	Dimensiune	Pret €	Ambalare
140 0144	16 x 2,0 - 1/2" F		10/100

1420K(PEX)

GHID DE CONEXIUNI

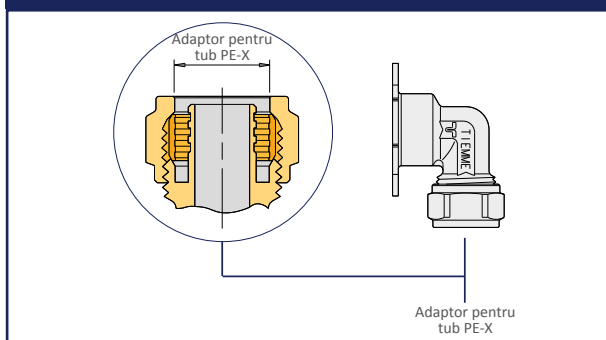
**1420P**

Doza de plastic pentru art. 1420K

Cod	Dimensiune	Pret €	Ambalare
147 0006	Teaca \varnothing 23 și \varnothing 27		1/50

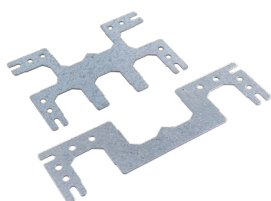
**1420Z**

Suport dublu pentru fixare 1420P

Cod	Interaxe	Pret €	Ambalare
147 0009	38 - 50 - 100		5/50
147 0007	38 - 150		5/50

**1505C04**

Tub de cupru cromat pentru legatura calorifere/alte elemente radiante

Cod	Dimensiune	Pret €	Ambalare
337 0001	\varnothing 15 x 1/2" L=150 mm		2/60

**1420K
1420K (PEX)**

EXEMPLU DE UTILIZARE

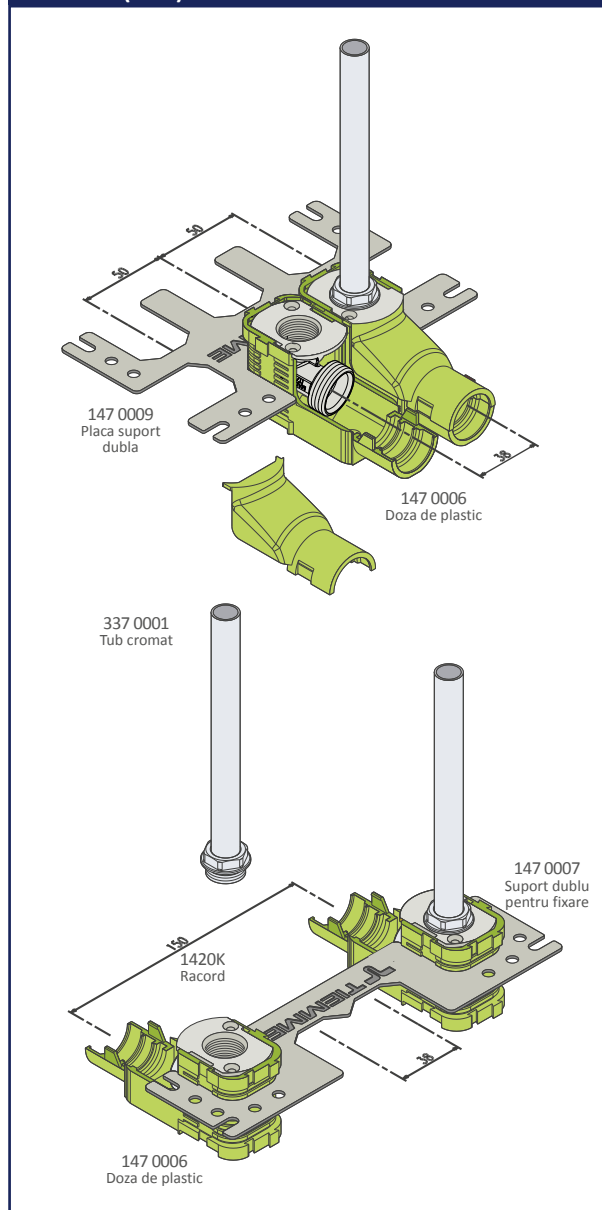

**1481**

Placa pentru cot cu flansa

1406

Cod	Dimensiune	Pret €	Ambalare
147 0005	unica		1/100

**1415**

Piulita

Cod	Dimensiune	Pret €	Ambalare
140 0212	16		50/700
140 0253	20		50/400
140 0257	25		10/200
140 0288	32		10/200

**1416**

Inel de compresie

Cod	Dimensiune	Pret €	Ambalare
140 0159	16		50/2300
140 0204	20		50/1200
140 0225	25		50/800
140 0220	32		10/400

INSTRUCTIUNI PENTRU UN MONTAJ CORECT - SERIA 1400

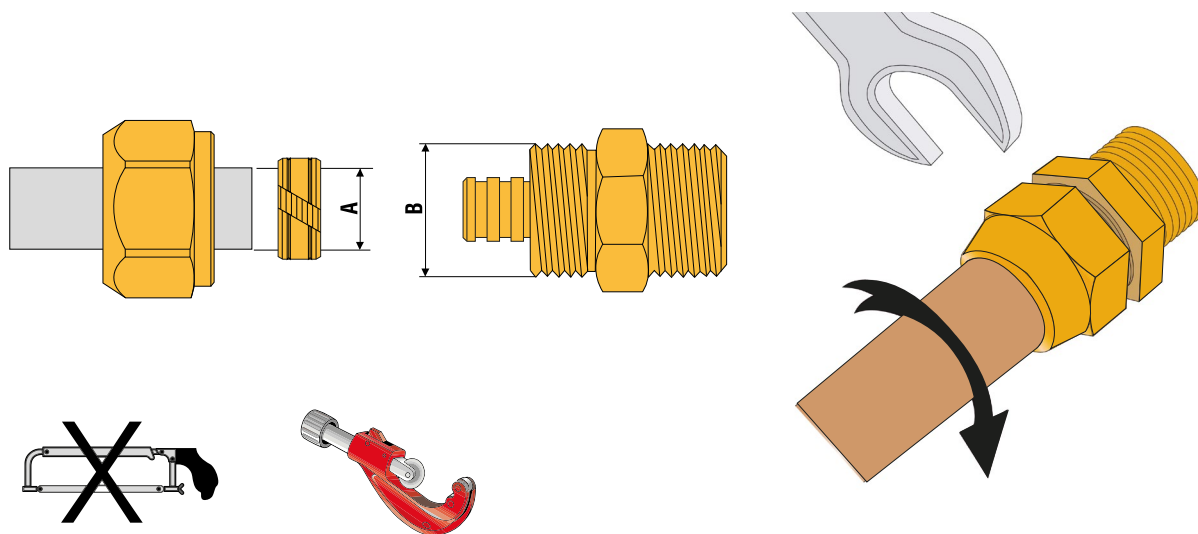
**TAIEREA TUBULUI**

Taierea tevii Pex se realizeaza cu instrumente speciale, care permit o tăiere fără bavuri și perfect perpendicular pe axa țevii.

DEBAVURAREA SI CURATAREA TEVII

Se debavureaza bine teava si se curata pentru eliminarea eventualelor reziduuri.

MONTAJUL RACORDULUI

Se monteaza piulita si inelul pe teava si apoi se introduce teava in mansonul racordului. Se insurubeaza la mana adaptorul si apoi in functie dimensiunea tevii Pex se strange cu cheia conform indicatiilor din tabel.

TABEL FILETE PIULITE





A	16	20	25	32
B	G 1/2"	G 3/4"	M32 x 1,5	M42 x 1,5

TABEL DE STRANGERE PIULITE nr ture

A	16	20	25	32
Nr. ture	1	1	1	1

05 RACORDURI DE PRESARE PENTRU TUB PEX "COBRAPEX"

Seria 1700

Racorduri de presare pentru tub PEX "COBRAPEX"		108
Robineti de presare pentru tub PEX "COBRAPEX"		116
Accesorii si piese de schimb		117
Unelte		118



GHID DE COMPATIBILITATE

Seria	Tub potrivit	Domeniu de aplicare	Caracteristici tehnice
1700	PE-X "COBRAPEX"	• Apa	Tmax: + 95 °C Pmax: 10 bar

Pentru detalii suplimentare consultati fisa tehnica



1700
Racord drept M

Cod	Dimensiune	Grosime	Pret €	Ambalare
170 0283	16 x 3/8"	1,5		10/100
170 0124	16 x 1/2"	1,5		10/100
170 0285	16 x 3/4"	1,5		10/100
170 0047	16 x 1/2"	1,8		10/100
170 0091	16 x 3/4"	1,8		10/100
170 0053	16 x 1/2"	2,0		10/100
170 0125	16 x 3/4"	2,0		10/100
170 0351	17 x 1/2"	2,0		10/100
170 0024	20 x 1/2"	1,9 și 2,0		10/100
170 0065	20 x 3/4"	1,9 și 2,0		10/100
170 0327	25 x 1/2"	2,3		10/50
170 0037	25 x 3/4"	2,3		10/50
170 0046	25 x 1"	2,3		5/25
170 0041	32 x 1"	2,9 și 3,0		5/25
170 0263	40 x 1"1/4	3,7		5/25
170 0264	50 x 1"1/2	4,6		1/16
170 0265	63 x 2"	5,8		1/16



1702
Racord drept F

Cod	Dimensiune	Grosime	Pret €	Ambalare
170 0291	16 x 1/2"	1,5		10/100
170 0292	16 x 3/4"	1,5		10/100
170 0043	16 x 1/2"	1,8		10/100
170 0100	16 x 1/2"	2,0		10/100
170 0350	17 x 1/2"	2,0		10/100
170 0035	20 x 1/2"	1,9 și 2,0		10/100
170 0059	20 x 3/4"	1,9 și 2,0		10/100
170 0328	25 x 1/2"	2,3		5/25
170 0062	25 x 3/4"	2,3		5/25
170 0067	25 x 1"	2,3		5/25
170 0064	32 x 1"	2,9 și 3,0		5/25
170 0268	40 x 1"1/4	3,7		5/25
170 0269	50 x 1"1/2	4,6		1/16



1715
Racord drept cu piulita si
garnitura plata

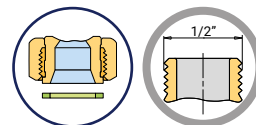

Cod	Dimensiune	Grosime	Pret €	Ambalare
170 0319	16 x 3/8"	1,5		10/100
170 0135	16 x 1/2"	1,5		10/100
170 0320	16 x 3/4"	1,5		10/100
170 0085	16 x 1/2"	1,8		10/100
170 0094	16 x 3/4"	1,8		10/100
170 0121	16 x 24 (19 fil)	1,8		10/100
170 0110	16 x 1/2"	2,0		10/100
170 0116	16 x 3/4"	2,0		10/100
170 0136	16 x 24 (19 fil)	2,0		10/100
170 0032	20 x 1/2"	1,9 și 2,0		10/100
170 0039	20 x 3/4"	1,9 și 2,0		10/100
170 0119	20 x 24 (19 fil)	1,9 și 2,0		10/100
170 0070	25 x 3/4"	2,3		2/100
170 0058	25 x 1"	2,3		2/100
170 0068	32 x 1"	2,9 și 3,0		2/100

La cerere



**1716**

Racord drept cu piulita

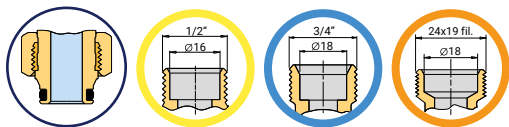

Cod	Dimensiune	Grosime	Pret €	Ambalare
170 0137	16 x 3/4" (ø18)	1,5		10/100
170 0103	16 x 1/2" (ø16)	1,8		10/100
170 0090	16 x 3/4" (ø18)	1,8		10/100
170 0118	16 x 24 x 19 fil (ø18)	1,8		10/100
170 0082	16 x 1/2" (ø16)	2,0		10/100
170 0086	16 x 3/4" (ø18)	2,0		10/100
170 0057	16 x 24 x 19 fil (ø18)	2,0		10/100
170 0352	17 x 3/4" (ø18)	2,0		10/100
170 0138	18 x 24 x 19 fil (ø18)	2,0		10/100
170 0093	20 x 1/2" (ø16)	1,9 și 2,0		10/100
170 0089	20 x 3/4" (ø18)	1,9 și 2,0		10/100
170 0095	20 x 24 x 19 fil (ø18)	1,9 și 2,0		10/100
170 0081	25 x 3/4" (ø18)	2,3		2/100

**1701**

Racord drept dublu

Cod	Dimensiune	Grosime	Pret €	Ambalare
170 0126	16 x 16	1,5		10/100
170 0040	16 x 16	1,8		10/100
170 0079	16 x 16	2,0		10/100
170 0353	17 x 17	2,0		10/100
170 0020	20 x 20	1,9 și 2,0		10/100
170 0013	25 x 25	2,3		5/50
170 0018	32 x 32	2,9 și 3,0		5/25
170 0266	40 x 40	3,7		5/25
170 0260	50 x 50	4,6		1/16
170 0267	63 x 63	5,8		1/16

**1701R**

Racord drept dublu redus

Cod	Dimensiune	Grosime	Pret €	Ambalare
170 0289	20 x 16	1,9 și 2,0 - 1,5		10/100
170 0042	20 x 16	1,9 și 2,0 - 1,8		10/100
170 0092	20 x 16	1,9 și 2,0 - 2,0		10/100
170 0061	25 x 16	2,3 - 1,8		10/100
170 0098	25 x 16	2,3 - 2,0		10/100
170 0026	25 x 20	2,3 - 1,9 și 2,0		10/100
170 0028	32 x 25	2,9 și 3,0 - 2,3		5/25
170 0364	40 x 32	3,7 - 2,9 și 3,0		5/25
170 0365	50 x 40	4,6 - 3,7		1/16
170 0366	63 x 50	5,8 - 4,6		1/16

**1718**

Racord de conexiune pentru țeavă Pex/țeavă din cupru prin sudură

Cod	Dimensiune	Pret €	Ambalare
170 0322	16 x 1,5 - 14		10/100
170 0323	16 x 1,5 - 16		10/100

**1704**

Cot M

Cod	Dimensiune	Grosime	Pret €	Ambalare
170 0297	16 x 1/2"	1,5		10/100
170 0074	16 x 1/2"	1,8		10/100
170 0105	16 x 1/2"	2,0		10/100
170 0038	20 x 1/2"	1,9 și 2,0		10/100
170 0332	20 x 3/4"	1,9 și 2,0		5/50
170 0044	25 x 3/4"	2,3		5/50

1705
Cot F

Cod	Dimensiune	Grosime	Pret €	Ambalare
170 0127	16 x 1/2"	1,5		10/100
170 0008	16 x 1/2"	1,8		10/100
170 0054	16 x 1/2"	2,0		10/100
170 0009	20 x 1/2"	1,9 și 2,0		10/100
170 0128	20 x 3/4"	1,9 și 2,0		5/25
170 0012	25 x 3/4"	2,3		5/25
170 0030	32 x 1"	2,9 și 3,0		5/25

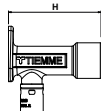
1706
Cot F cu flansa cu 2 gauri de prindere, cu gat scurt

Cod	Dimensiune	Grosime	H	Pret €	Ambalare
170 0129	16 x 1/2"	1,5	40 mm		10/50
170 0004	16 x 1/2"	1,8	40 mm		10/50
170 0087	16 x 1/2"	2,0	40 mm		10/50
170 0006	20 x 1/2"	1,9 și 2,0	40 mm		5/50
170 0022	25 x 3/4"	2,3	40 mm		5/25

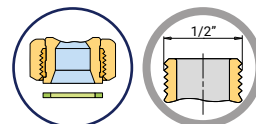
1710
Racord cot cu piulita si garnitura plata

Cod	Dimensiune	Grosime	Pret €	Ambalare
170 0315	16 x 1/2"	1,5		5/100
170 0316	16 x 3/4"	1,5		5/100
170 0084	16 x 1/2"	1,8		5/100
170 0114	16 x 1/2"	2,0		5/100
170 0113	20 x 1/2"	1,9 și 2,0		5/100
170 0060	20 x 3/4"	1,9 și 2,0		5/100
170 0076	25 x 3/4"	2,3		5/50

La cerere

1703
Cot dublu

Cod	Dimensiune	Grosime	Pret €	Ambalare
170 0294	16 x 16	1,5		10/100
170 0015	16 x 16	1,8		10/100
170 0066	16 x 16	2,0		10/100
170 0002	20 x 20	1,9 și 2,0		10/100
170 0001	25 x 25	2,3		5/25
170 0007	32 x 32	2,9 și 3,0		5/25
170 0270	40 x 40	3,7		5/25
170 0259	50 x 50	4,6		1/8
170 0271	63 x 63	5,8		1/8



**1730**

Cot cu flansa feminin de utilizat cu art. 1420P

Cod	Dimensiune	Pret €	Ambalare
170 0333	16 x 1,5 - 1/2"		10/100
170 0144	16 x 2,0 - 1/2"		10/100
170 0151	18 x 2,0 - 1/2"		10/100

Disponibil si in varianta cromata

**1420P**

Doza de plastic

Cod	Dimensiune	Pret €	Ambalare
147 0006	pentru teaca Ø 23 si Ø 27		1/50

**1420Z**

Suport dublu pentru fixare 1420P

Cod	Dimensiune	Pret €	Ambalare
147 0009	int. 38, 50 sau 100		5/50
147 0007	int. 38 sau 150		5/50

**1505C04**

Tub din cupru cromat pentru legătură elemente radiante

Cod	Dimensiune	Pret €	Ambalare
337 0001	Ø15 x 1/2" L=150 mm		2/60

**1722CY**

Tub din cupru cromat pentru legătură elemente radiante

Cod	Dimensiune	Grosime	Pret €	Ambalare
Teava de cupru Ø 15 L=160				
170 0355	17	2,0		5/50

1730 - 1420P
1420Z - 1505C04

EXEMPLU DE UTILIZARE

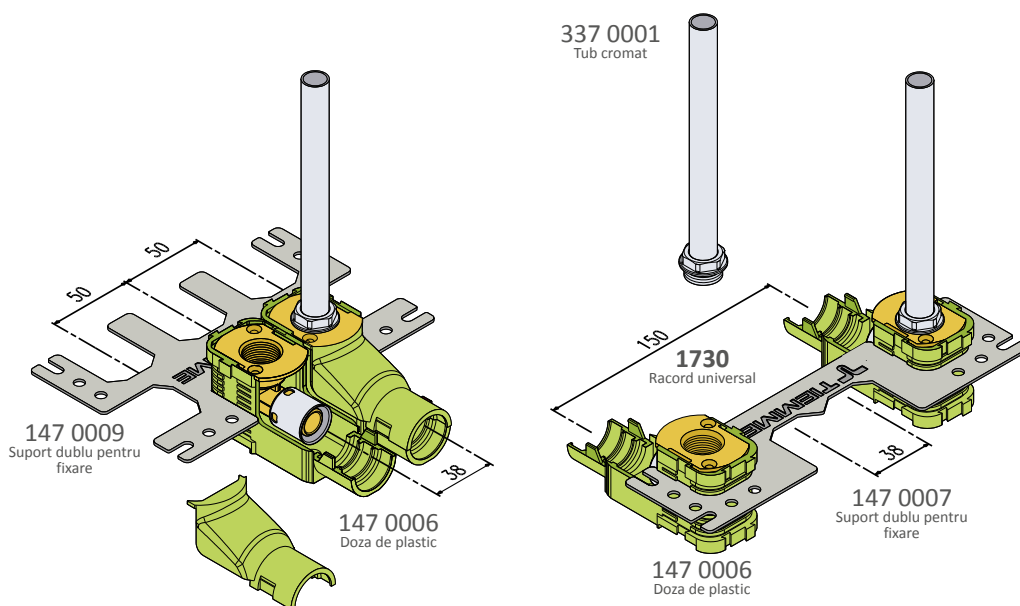

**1721U**

Cot dublu F cu flansa "U" cu gat scurt. H=40 mm

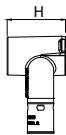
**+ ANTI - LEGIONELA**

Cod	Dimensiune	Grosime	H	Pret €	Ambalare
170 0339	16 x 1/2"	1,8	40 mm		5/50
170 0340	16 x 1/2"	2,0	40 mm		5/50
170 0341	20 x 1/2"	1,9 și 2,0	40 mm		5/50

**1704U**

Cot dublu M "U"

+ ANTI - LEGIONELA

Cod	Dimensiune	Grosime	Pret €	Ambalare
170 0347	16 x 1/2"	1,8		5/50
170 0348	16 x 1/2"	2,0		5/50
170 0349	20 x 1/2"	1,9 și 2,0		5/50

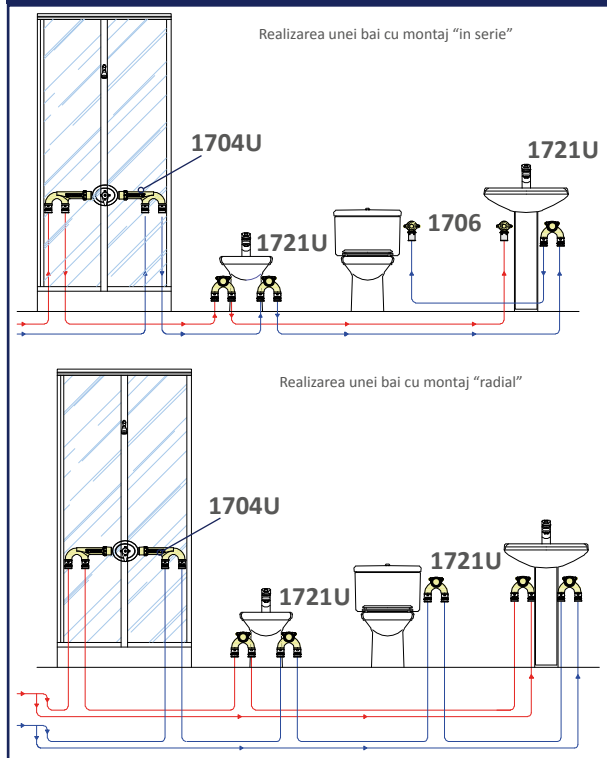
1721U - 1704U EXEMPLU DE UTILIZARE**1709**

Teu F

Cod	Dimensiune	Grosime	Pret €	Ambalare
170 0134	16 x 1/2" x 16	1,5		10/100
170 0033	16 x 1/2" x 16	1,8		10/100
170 0104	16 x 1/2" x 16	2,0		10/100
170 0023	20 x 1/2" x 20	1,9 și 2,0		5/50
170 0025	25 x 3/4" x 25	2,3		5/25
170 0071	32 x 1" x 32	2,9 și 3,0		5/25

**1707**

Teu

Cod	Dimensiune	Grosime	Pret €	Ambalare
170 0300	16 x 16 x 16	1,5		10/50
170 0021	16 x 16 x 16	1,8		10/50
170 0073	16 x 16 x 16	2,0		10/50
170 0005	20 x 20 x 20	1,9 și 2,0		5/50
170 0011	25 x 25 x 25	2,3		5/25
170 0029	32 x 32 x 32	2,9 și 3,0		5/25
170 0275	40 x 40 x 40	3,7		1/20
170 0276	50 x 50 x 50	4,6		1/10
170 0277	63 x 63 x 63	5,8		1/5

**1707R**

Teu redus

Cod	Dimensiune			Grosime	Pret €	Ambalare
	1	2	3			
170 0304	16	20	16	1,5-1,9 și 2,0-1,5		5/50
170 0072	16	20	16	1,8-1,9 și 2,0-1,8		5/50
170 0106	16	20	16	2,0-1,9 și 2,0-2,0		5/50
170 0080	16	25	16	1,8-2,3-1,8		5/25
170 0130	16	25	16	2,0-2,3-2,0		5/25
170 0308	20	16	16	1,9 și 2,0-1,5-1,5		5/50
170 0017	20	16	16	1,9 și 2,0-1,8-1,8		5/50



1707 - Teu redus

Cod	Dimensiune			Grosime	Pret €	Ambalare
	1	2	3			
170 0101	20 x 16 x 16			1,9 și 2,0-2,0-2,0		5/50
170 0309	20 x 16 x 20			1,9 și 2,0-1,5-1,9 și 2,0		5/50
170 0003	20 x 16 x 20			1,9 și 2,0-1,8-1,9 și 2,0		5/50
170 0102	20 x 16 x 20			1,9 și 2,0-2,0-1,9 și 2,0		5/50
170 0310	20 x 20 x 16			1,9 și 2,0-1,9 și 2,0-1,5		5/50
170 0019	20 x 20 x 16			1,9 și 2,0-1,9 și 2,0-1,8		5/50
170 0107	20 x 20 x 16			1,9 și 2,0-1,9 și 2,0-2,0		5/50
170 0050	20 x 25 x 20			1,9 și 2,0-2,3-1,9 și 2,0		5/25
170 0051	25 x 16 x 16			2,3-1,8-1,8		5/25
170 0131	25 x 16 x 16			2,3-2,0-2,0		5/25
170 0031	25 x 16 x 20			2,3-1,8-1,9 și 2,0		5/25
170 0132	25 x 16 x 20			2,3-2,0-1,9 și 2,0		5/25
170 0016	25 x 16 x 25			2,3-1,8-2,3		5/25
170 0099	25 x 16 x 25			2,3-2,0-2,3		5/25
170 0056	25 x 20 x 16			2,3-1,9 și 2,0-1,8		5/25
170 0133	25 x 20 x 16			2,3-1,9 și 2,0-2,0		5/25
170 0014	25 x 20 x 20			2,3-1,9 și 2,0-1,9 și 2,0		5/25
170 0010	25 x 20 x 25			2,3-1,9 și 2,0-2,3		5/25
170 0052	25 x 25 x 16			2,3-2,3-1,8		5/25
170 0088	25 x 25 x 16			2,3-2,3-2,0		5/25
170 0027	25 x 25 x 20			2,3-2,3-1,9 și 2,0		5/25
170 0077	25 x 32 x 25			2,3-2,9 și 3,0-2,3		5/25
170 0069	32 x 25 x 25			2,9 și 3,0-2,3-2,3		5/25
170 0372	32 x 20 x 32			2,9 și 3,0-1,9 și 2,0-2,9 și 3,0		5/25
170 0048	32 x 25 x 32			2,9 și 3,0-2,3-2,9 și 3,0		5/25
170 0083	32 x 32 x 25			2,9 și 3,0-2,9 și 3,0-2,3		5/25
170 0370	40 x 20 x 40			3,7 - 1,9 și 2,0 - 3,7		1/20
170 0371	40 x 25 x 32			3,7 - 2,3 - 2,9 și 3,0		1/20
170 0356	40 x 25 x 40			3,7 - 2,3 - 3,7		1/20
170 0368	40 x 32 x 32			3,7 - 2,9 și 3,0-2,9 și 3,0		1/20
170 0367	40 x 40 x 32			3,7-3,7-2,9 și 3,0		1/20
170 0357	50 x 25 x 50			4,6 - 2,3 - 4,6		1/10
170 0358	50 x 40 x 40			4,6 - 3,7 - 3,7		1/10
170 0359	50 x 40 x 50			4,6 - 3,7 - 4,6		1/10
170 0360	50 x 50 x 32			4,6 - 4,6 - 2,9 și 3,0		1/10
170 0361	63 x 25 x 63			5,8 - 2,3 - 5,8		1/5
170 0362	63 x 40 x 63			5,8 - 3,7 - 5,8		1/5
170 0363	63 x 50 x 63			5,8 - 4,6 - 5,8		1/5

Racordurile Ø 20 pot fi utilizate pentru tevi cu grosimea 1,9 și 2,0

Racordurile Ø 32 pot fi utilizate pentru tevi cu grosimea 2,9 și 3,0

La cerere

**1719CG**

Consola cu racorduri 105° finale pentru peretii din ghips sp. 13 mm

BREVETAT

Interax: 150 mm

Cod	Dimensiune	Grosime	Pret €	Ambalare
170 0331	16 x 1/2"	1,5		1/5

**1719CGXL**

Consola cu racorduri 105° finale pentru peretii din ghips sp. 20 mm

BREVETAT

Interax: 150 mm

Cod	Dimensiune	Grosime	Pret €	Ambalare
170 0334	16 x 1/2"	1,8		1/5
170 0330	16 x 1/2"	2,0		1/5
170 0337	20 x 1/2"	1,9 și 2,0		1/5

La cerere

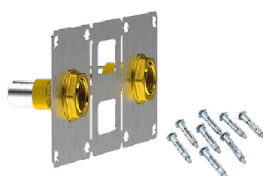
**1702CG**

Consola cu racorduri drepte finale pentru peretii din ghips

BREVETAT

Interax: 150 mm

Cod	Dimensiune	Grosime	Pret €	Ambalare
170 0369	16 x 1/2"	1,5		1/5

1719CG - 1702CG - 1719CGXL

INSTRUCIUNI DE MONTAJ

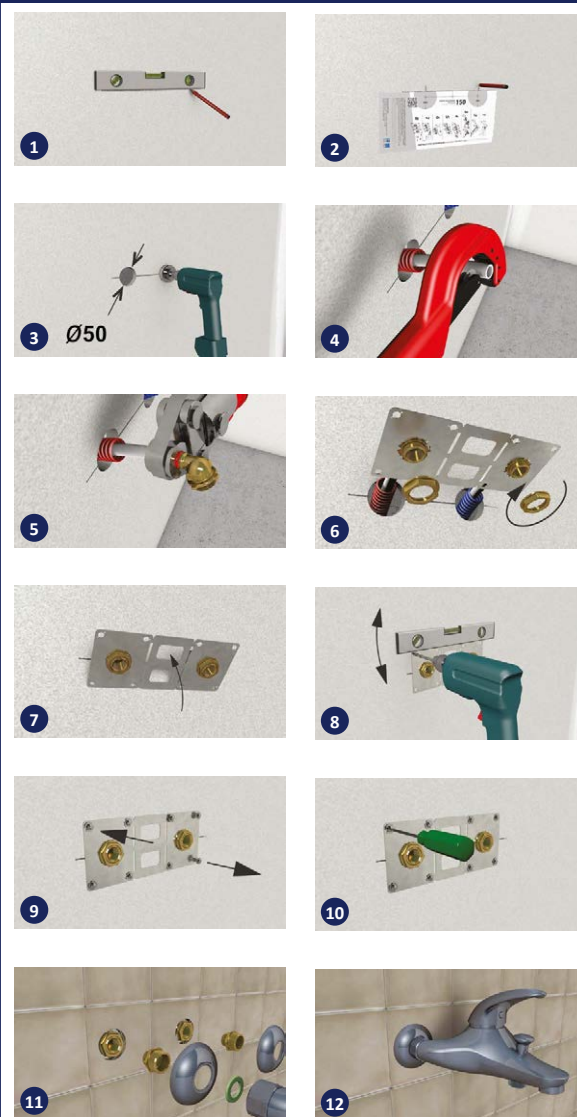



1735
Cruce

Cod	Dimensiune	Grosime	Pret €	Ambalare
170 0055	20 x 20 x 16 x 16	1,9 și 2,0 - 1,9 și 2,0 - 1,8 - 1,8		5/25
170 0146	20 x 20 x 16 x 16	1,9 și 2,0 - 1,9 și 2,0 - 2,0 - 2,0		5/25
170 0111	20 x 16 x 20 x 16	1,9 și 2,0 - 1,8 - 1,9 și 2,0 - 1,8		5/25
170 0145	20 x 16 x 20 x 16	1,9 și 2,0 - 2,0 - 1,9 și 2,0 - 2,0		5/25
170 0109	20 x 20 x 20 x 20	1,9 și 2,0 - 1,9 și 2,0 - 1,9 și 2,0 - 1,9 și 2,0		5/25
170 0036	25 x 20 x 16 x 16	2,3 - 1,9 și 2,0 - 1,8 - 1,8		5/20
170 0148	25 x 20 x 16 x 16	2,3 - 1,9 și 2,0 - 2,0 - 2,0		5/20
170 0108	25 x 20 x 20 x 20	2,3 - 1,9 și 2,0 - 1,9 și 2,0 - 1,9 și 2,0		5/20
170 0097	25 x 16 x 20 x 16	2,3 - 1,8 - 1,9 și 2,0 - 1,8		5/20
170 0147	25 x 16 x 20 x 16	2,3 - 2,0 - 1,9 și 2,0 - 2,0		5/20

Racordurile Ø 20 pot fi utilizate pentru tevi cu grosimea 1,9 și 2,0



1736
Colector 5 cai

Cod	Dimensiune					Grosime	Pret €	Ambalare
	1	2	3	4	5			
170 0049	20	20	16	16	16	1,9 și 2,0 - 1,9 și 2,0-1,8-1,8-1,8		5/20
170 0149	20	20	16	16	16	1,9 și 2,0 - 1,9 și 2,0-2,0-2,0-2,0		5/20
170 0096	20	20	20	20	20	1,9 și 2,0 - 1,9 și 2,0-1,9 și 2,0-1,9 și 2,0-1,9 și 2,0		5/20
170 0034	25	20	16	16	16	2,3 - 1,9 și 2,0-1,8-1,8-1,8		5/20
170 0150	25	20	16	16	16	2,3 - 1,9 și 2,0-2,0-2,0-2,0		5/20
170 0112	25	20	20	20	20	2,3 - 1,9 și 2,0-1,9 și 2,0-1,9 și 2,0-1,9 și 2,0		5/20

Racordurile Ø 20 pot fi utilizate pentru tevi cu grosimea 1,9 și 2,0

**1740**

Robinet cu sfera de incastrat



Cod	Dimensiune	Grosime	Pret €	Ambalare
174 0005	16 x 16	1,8		5/50
174 0010	16 x 16	2,0		5/50
174 0002	20 x 20	1,9 și 2,0		5/50
174 0003	25 x 25	2,3		5/50

**1740U**

Robinet cu sfera de incastrat in forma de U



Cod	Dimensiune	Grosime	Pret €	Ambalare
174 0007	16 x 16	1,8		1/25
174 0011	16 x 16	2,0		1/25
174 0001	20 x 20	1,9 și 2,0		1/25
174 0004	25 x 25	2,3		1/25

**1746**

Robinet cu obertein de incastrat 2 cai



Cod	Dimensiune	Grosime	Pret €	Ambalare
174 0008	16 x 16	1,8		5/50
174 0009	16 x 16	2,0		5/50
174 0006	20 x 20	1,9 și 2,0		5/50

**1740 - 1740U
1746**

CONFIGURATII

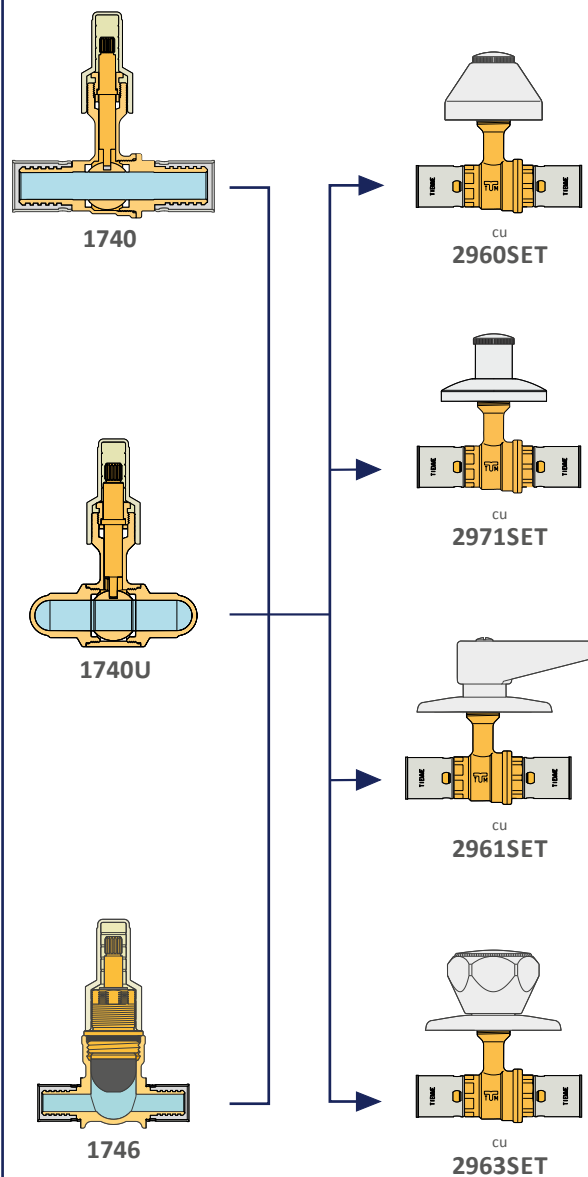



2960SET

Set format din capac si rozeta pentru robinetii de incastat Art. 2960, 1690, 1690U, 1696, 1740, 1740U si 1746

Cod	Dimensiune	Pret €	Ambalare
295 0006	-		1/25



2971SET

Set format din capac si rozeta pentru robinetii de incastat Art. 2960, 1690, 1690U, 1696, 1740, 1740U si 1746

Cod	Dimensiune	Pret €	Ambalare
295 0167	-		1/25



2963SET

Set maneta si rozeta decorativa pentru robinetii de incastat Art. 2960, 1690, 1690U, 1696, 1740, 1740U si 1746

Cod	Dimensiune	Pret €	Ambalare
295 0014	-		1/25



2961SET

Set maneta si rozeta decorativa pentru robinetii de incastat Art. 2960, 1690, 1690U, 1696, 1740, 1740U si 1746

Cod	Dimensiune	Pret €	Ambalare
295 0009	-		1/25



2960PR

Set de prelungire pentru robinet Art. 2960, 1690, 1690U, 1696, 1740, 1740U si 1746

Cod	Dimensiune	Pret €	Ambalare
295 0015	-		1/100



1481

Suport pentru cot cu flansa Pentru 1706

Cod	Dimensiune	Pret €	Ambalare
147 0005	unica		1/100



1720X

Manson din Inox

Cod	Dimensiune	Grosime	Pret €	Ambalare
170 0336	16	1,5		10/350
170 0123	16	1,8		10/350
170 0117	16	2,0		10/350
170 0354	17	2,0		10/350
170 0152	18	2,0		10/350
170 0115	20	1,9 și 2,0		10/300
170 0122	25	2,3		10/200
170 0120	32	2,9 și 3,0		10/150

La cerere



1670B

Manson din Inox

Cod	Dimensiune	Grosime	Pret €	Ambalare
170 0324	40	3,7		10/100
170 0325	50	4,6		1/50
170 0326	63	5,8		1/30



1681RF

Capete de presare - RF profile - personalizat TIEMME

i Pentru accesorii vezi Cap. 8A

Cod	Dimensiune	Pret €	Ambalare
159 0038	16		1/1
159 0129	17		1/1
159 0051	18		1/1
159 0039	20		1/1
159 0040	25		1/1
159 0042	32		1/1



1681MINIRF

Capete de presare - RF profile - personalizat TIEMME pentru presa MINI

i Pentru accesorii vezi Cap. 8A

Cod	Dimensiune	Pret €	Ambalare
159 0032	16		1/1
159 0130	17		1/1
159 0052	18		1/1
159 0029	20		1/1
159 0033	25		1/1
159 0035	32		1/1



1681

Capete de presare - TH PROFILE - personalizat TIEMME

i Pentru accesorii vezi Cap. 8A

Cod	Dimensiune	Pret €	Ambalare
159 0010	40		1/1
159 0008	50		1/1
159 0012	63		1/1

Capete de presare cu 3 sectoare

DIMENSIUNI DE GABARIT PENTRU CAPETELE DE PRESARE

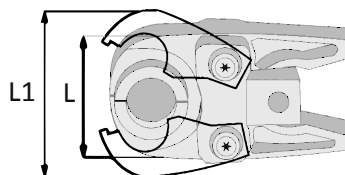

Cod	Dimensiune	L (mm)	L1 (mm)
159 0038	16	101	104
159 0129	17	101	104
159 0051	18	101	104
159 0039	20	101	104
159 0040	25	101	115
159 0042	32	101	115
159 0010	40	101	120
159 0008	50	165	175
159 0012	63	175	185
159 0032	16	101	101
159 0130	17	101	101
159 0052	18	101	101
159 0029	20	101	101
159 0033	25	101	108
159 0035	32	101	108

L=falcile in pozitia inchis
L1=falcile in pozitia deschis



INSTRUCIUNI DE MONTAJ DE LA Ø12 LA Ø32

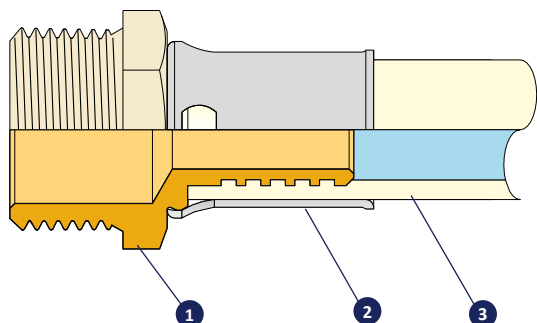

- 1 Corpul racordului din alama
- 2 Manson de sertizare din oțel inox AISI 304
- 3 Tub din polietilena reticulata "PEX"

Fitingurile de presare se caracterizează prin sistemul de etanșare care se formează prin deformarea mecanică a mansonului din oțel inoxidabil. Această deformare se realizează cu ajutorul unui instrument special echipat cu clești de oțel corespunzători; Procedând astfel, puteți fi siguri că presiunea de strângere rămâne întotdeauna aceeași și la un nivel optim pentru toate fittingurile, crescând fiabilitatea îmbinării. Fitingurile de presare Tiemme se caracterizează și prin prezența a patru ferestre cu o funcție de importanță fundamentală, ceea ce permite instalatorului să verifice vizual și ușor dacă și când țeava este introdusă corect în fitting. Aceasta posibilitate de verificare simplă și imediată garantează un montaj fiabil și rapid față de alte tipuri de fittinguri.

Pentru a obține o îmbinare perfectă trebuie efectuate câteva operații simple, dar importante.

1. TĂIEREA ȚEVII

Mai întâi trebuie să tăiați tubul la dimensiunea dorită. Pentru a efectua tăierea este indicat să folosiți un tăietor de țevi sau foarfeca adecvată, asigurându-vă că tăierea este cât mai perpendiculară pe axa țevii.

2. CONECTAREA TUBULUI LA FITING

Introduceți țeava în fitting până când ajunge la capăt (verificați prin „fereastra” mansonului).

3. PRESARE

Înainte de a trece la presarea fittingului este necesar să se verifice dacă mansonul este corect asamblat pe locul specific realizat pe fittingul din alama, dacă este necesară repositionarea mansonului. În cazul instalării cu montaj îngropat în beton lichid, sau în orice caz de montaj îngropat, se recomandă protejarea legăturilor dintre fittinguri și țeavă pentru a le izola de eventuale contacturi cu masa de beton.

Vă reamintim că profilul fâlcilor ce urmează a fi folosit pentru presarea fittingurilor TIEMME trebuie să fie de tip RF.

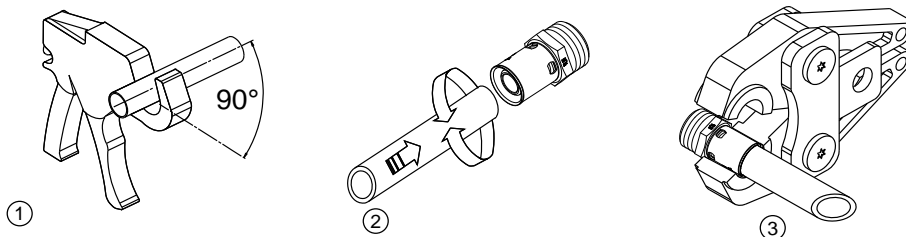

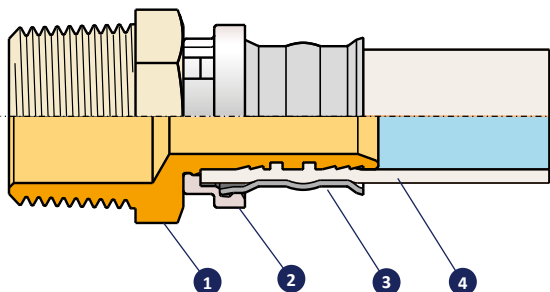
INSTRUCIUNI DE MONTAJ $\varnothing 40 - \varnothing 50 - \varnothing 63$ 

- 1 Corpul racordului din alama
- 2 Inel din plastic, permite sa se vada daca tubul a fost bine introdus in racord si izoleaza dielectric tubul fata de corpul racordului
- 3 Manson de sertizare din oțel inoxid AISI 304
- 4 Tub din polietilena reticulata "PEX"

Fitingurile de presare se caracterizează prin sistemul de etanșare care se formează prin deformarea mecanică a mansonului din oțel inoxidabil. Această deformare se realizează cu ajutorul unui instrument special echipat cu clești de oțel corespunzător; Procedând astfel, puteți fi siguri că presiunea de strângere rămâne întotdeauna aceeași și la un nivel optim pentru toate fittingurile, crescând fiabilitatea îmbinării. Fitingurile de presare Tiemme se caracterizează și prin prezența a patru ferestre cu o funcție de importanță fundamentală, ceea ce permite instalatorului să verifice vizual și ușor dacă și când țeava este introdusă corect în fitting. Aceasta posibilitate de verificare simplă și imediată garantează un montaj fiabil și rapid față de alte tipuri de fittinguri.

Pentru a obține o îmbinare perfectă trebuie efectuate câteva operații simple, dar importante.

1. TĂIEREA ȚEVII

Mai întâi trebuie să tăiați tubul la dimensiunea dorită. Pentru a efectua tăierea este indicat să folosiți un tăietor de țevi sau foarfeca adecvată, asigurându-vă că tăierea este cât mai perpendiculară pe axa țevii.

2. CONECTAREA TUBULUI LA FITING

Introduceți țeava în fitting până când ajunge la capăt (verificați prin „fereastra” mansonului).

3. PRESARE

Înainte de a trece la presarea fittingului este necesar să se verifice dacă mansonul este corect asamblat pe locul specific realizat pe fittingul din alama, dacă este necesară repositionarea mansonului. În cazul instalării cu montaj îngropat în beton lichid, sau în orice caz de montaj îngropat, se recomandă protejarea legăturilor dintre fittinguri și țeavă pentru a le izola de eventualul contact cu masa de beton.



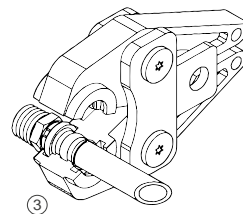
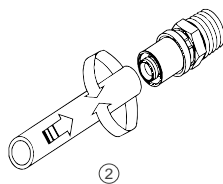
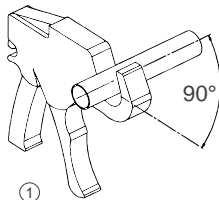

Vă reamintim că profilul fălcilor ce urmează a fi folosit pentru presarea fittingurilor TIEMME trebuie să fie de tip TH.



06

RACORDURI DE COMPRESIE PENTRU TUB DIN CUPRU CU INEL DIN ALAMĂ

Seria 1000/1100

Racorduri de compresie pentru tub din cupru cu inel din alamă - seria 1000		122
Racorduri de compresie pentru tub din cupru cu inel din alamă - seria 1100		125
Accesorii		130
Piese de schimb		132

kiwa



GHID DE COMPATIBILITATE

Seria	Tub potrivit	Stut de ranforsare	Domeniu de aplicare	Caracteristici tehnice
1000	Cupru	-	<ul style="list-style-type: none"> • Apa • Gaz • Instalatii solare 	Tmax: + 200 °C Pmax: 30 bar/10 bar (cu abur)
	Cupru calit	Art. 1116	<ul style="list-style-type: none"> • Apa • Gaz • Instalatii solare 	Tmax: + 200 °C Pmax: 30 bar /10 bar (cu abur)
	PE-X	Art. 1120	<ul style="list-style-type: none"> • Apa 	Tmax: + 95 °C Pmax: 10 bar
1100	Cupru	-	<ul style="list-style-type: none"> • Apa • Instalatii solare 	Tmax: + 200 °C Pmax: 30 bar /10 bar (cu abur)
	Cupru calit	Art. 1116	<ul style="list-style-type: none"> • Apa • Instalatii solare 	Tmax: + 200 °C Pmax: 30 bar /10 bar (cu abur)
	PE-X	Art. 1120	<ul style="list-style-type: none"> • Apa 	Tmax: + 95 °C Pmax: 10 bar

Pentru detalii suplimentare consultati fisa tehnica

1000
Racord drept M

i Disponibil și în varianta nichelat

Cod	Dimensiune	Pret €	Ambalare
100 0110	10 x 1/4"		10/100
100 0080	10 x 3/8"		10/100
100 0057	10 x 1/2"		10/100
100 0152	12 x 1/4"		10/100
100 0091	12 x 3/8"		10/100
100 0038	12 x 1/2"		10/100
100 0070	15 x 3/8"		10/100
100 0011	15 x 1/2"		10/100
100 0064	15 x 3/4"		5/100
100 0065	22 x 1/2"		5/100
100 0009	22 x 3/4"		5/100
100 0071	22 x 1"		5/75
100 0078	28 x 3/4"		5/75
100 0042	28 x 1"		5/50

1002
Racord drept F

i Disponibil și în varianta nichelat

Cod	Dimensiune	Pret €	Ambalare
100 0176	10 x 1/4"		10/100
100 0126	10 x 3/8"		10/100
100 0031	10 x 1/2"		10/100
100 0128	12 x 3/8"		10/100
100 0041	12 x 1/2"		10/100
100 0142	15 x 3/8"		10/100
100 0019	15 x 1/2"		10/100
100 0049	15 x 3/4"		5/100
100 0052	22 x 1/2"		5/100
100 0007	22 x 3/4"		5/100
100 0105	22 x 1"		5/75
100 0129	28 x 3/4"		5/50
100 0043	28 x 1"		5/50

1001
Racord drept dublu

i Disponibil și în varianta nichelat

Cod	Dimensiune	Pret €	Ambalare
100 0045	10 x 10		10/100
100 0047	12 x 12		10/100
100 0004	15 x 15		10/100
100 0001	22 x 22		5/75
100 0032	28 x 28		5/50
Redus			
100 0100	12 x 10		10/100
100 0106	15 x 10		10/100
100 0069	15 x 12		10/100
100 0044	22 x 15		5/100
100 0193	28 x 15		5/75
100 0089	28 x 22		5/50

1004
Cot M

i Disponibil și în varianta nichelat

Cod	Dimensiune	Pret €	Ambalare
100 0169	10 x 3/8"		10/100
100 0130	12 x 3/8"		10/100
100 0077	12 x 1/2"		10/100
100 0027	15 x 1/2"		10/100
100 0063	15 x 3/4"		5/100
100 0140	22 x 1/2"		5/100
100 0018	22 x 3/4"		5/75
100 0099	22 x 1"		5/50
100 0187	28 x 3/4"		5/50
100 0109	28 x 1"		5/50



1005
Cot F

i Disponibil si in varianta nichelat

Cod	Dimensiune	Pret €	Ambalare
100 0164	12 x 3/8"		10/100
100 0073	12 x 1/2"		10/100
100 0157	15 x 3/8"		10/100
100 0016	15 x 1/2"		10/100
100 0067	15 x 3/4"		5/75
100 0084	22 x 1/2"		5/100
100 0017	22 x 3/4"		5/75
100 0053	22 x 1"		5/50
100 0156	28 x 3/4"		5/50
100 0074	28 x 1"		5/25

1003
Cot dublu

i Disponibil si in varianta nichelat

Cod	Dimensiune	Pret €	Ambalare
100 0024	10 x 10		10/100
100 0029	12 x 12		10/100
100 0002	15 x 15		10/100
100 0003	22 x 22		5/75
100 0015	28 x 28		5/25
Redus			
100 0145	12 x 10		10/100
100 0107	15 x 12		10/100
100 0054	22 x 15		5/100
100 0148	28 x 22		5/50

1009
Teu F cu filet ISO7/EN 10226

i Disponibil si in varianta nichelat

Cod	Dimensiune	Pret €	Ambalare
100 0132	12 x 3/8" x 12		10/100
100 0093	12 x 1/2" x 12		10/100
100 0200	15 x 1/4" x 15		10/100
100 0023	15 x 1/2" x 15		10/100
100 0014	22 x 1/2" x 22		5/50
100 0066	22 x 3/4" x 22		5/50
100 0194	22 x 1" x 22		5/25
100 0101	28 x 1/2" x 28		5/25
100 0117	28 x 3/4" x 28		5/25
100 0127	28 x 1" x 28		5/25

1039
Teu lateral F

i Disponibil si in varianta nichelat

Cod	Dimensiune	Pret €	Ambalare
100 0062	15 x 15 x 1/2"		10/100
100 0022	22 x 22 x 1/2"		5/60
100 0112	22 x 22 x 3/4"		5/50



3 1007
Teu



1

2

i Disponibil si in varianta nichelat

Cod	Dimensiune			Pret €	Ambalare
	1	2	3		
100 0061	10	10	10		10/100
100 0050	12	12	12		10/100
100 0005	15	15	15		10/100
100 0013	22	22	22		5/50
100 0060	28	28	28		5/25
Redus					
100 0151	12	15	12		10/100
100 0177	15	12	12		10/100
100 0116	15	12	15		10/100
100 0185	15	15	12		10/100
100 0133	15	22	15		5/50
100 0086	22	15	15		5/50
100 0020	22	15	22		5/50
100 0056	22	22	15		5/50
100 0212	22	28	22		5/25
100 0216	28	15	22		5/25
100 0108	28	15	28		5/25
100 0174	28	22	22		5/25
100 0103	28	22	28		5/25
100 0189	28	28	15		5/25
100 0183	28	28	22		5/25



1037
Teu în unghi



i Disponibil si in varianta nichelat

Cod	Dimensiune	Pret €	Ambalare
100 0158	15 x 15 x 15		10/100
100 0198	22 x 15 x 15		5/50
100 0196	22 x 15 x 22		5/50

Până la terminarea stocului



1010
Racord cruce



i Disponibil si in varianta nichelat

Cod	Dimensiune	Pret €	Ambalare
100 0059	15 x 15 x 15 x 15		5/50
100 0082	22 x 22 x 22 x 22		5/25
Redus			
100 0217	22 x 15 x 15 x 15		5/50
100 0165	22 x 15 x 22 x 15		5/50
100 0225	22 x 22 x 15 x 15		5/50

Până la terminarea stocului



1035
Dop final



i Disponibil si in varianta nichelat

Cod	Dimensiune	Pret €	Ambalare
100 0150	10		10/600
100 0095	12		10/400
100 0028	15		10/350
100 0012	22		5/150
100 0098	28		5/100



LISTA DE PREȚURI



1100
Racord drept M

 Disponibil si in varianta nichelat

Cod	Dimensiune	Pret €	Ambalare
110 0124	08 x 1/4"		10/200
110 0136	08 x 3/8"		10/100
110 0019	10 x 1/2"		10/100
110 0206	14 x 3/8"		10/100
110 0072	14 x 1/2"		10/100
110 0001	15 x 1/2"		10/100
110 0023	15 x 3/4"		5/100
110 0214	16 x 3/8"		10/100
110 0044	16 x 1/2"		10/100
110 0118	16 x 3/4"		5/100
110 0009	18 x 1/2"		10/100
110 0277	18 x 1/2" ISO7		10/100
110 0011	18 x 3/4"		5/100
110 0278	18 x 3/4" ISO7		5/100
110 0279	18 x 1" ISO7		5/75
110 0034	22 x 1/2"		5/100
110 0002	22 x 3/4"		5/100
110 0017	22 x 1"		5/75
110 0008	28 x 1"		5/75
110 0100	28 x 1" 1/4		1/50
110 0082	35 x 1"		1/50
110 0022	35 x 1" 1/4		1/25
110 0069	42 x 1" 1/2		1/25
110 0053	54 x 2"		1/10



1100FD
Racord drept pentru teava de
cupru - masculin fata dreapta

Cod	Dimensiune	Pret €	Ambalare
471 0023	15 x 1/2"		10/100
471 0010	15 x 3/4"		5/100
471 0048	16 x 1/2"		10/100
471 0026	18 x 1/2"		10/100
471 0009	18 x 3/4"		5/100
471 0065	18 x 1"		5/100
471 0066	22 x 1/2"		5/100
471 0001	22 x 3/4"		5/100
471 0007	22 x 1"		5/75
471 0042	28 x 1" 1/4		1/50



1102
Racord drept F

 Disponibil si in varianta nichelat

Cod	Dimensiune	Pret €	Ambalare
110 0167	08 x 1/4"		10/100
110 0141	08 x 3/8"		10/100
110 0094	14 x 1/2"		10/100
110 0223	14 x 3/4"		5/100
110 0007	15 x 1/2"		10/100
110 0095	16 x 1/2"		10/100
110 0187	16 x 3/4"		5/100
110 0024	18 x 1/2" ISO7		10/100
110 0026	18 x 3/4"		5/100
110 0275	18 x 3/4" ISO7		5/100
110 0276	18 x 1" ISO7		5/75
110 0039	22 x 1"		5/75
110 0066	35 x 1" 1/4		1/50
110 0099	42 x 1" 1/2		1/25
110 0083	54 x 2"		1/10



1102FD
Racord drept pentru teava de
cupru - feminin fata dreapta

Cod	Dimensiune	Pret €	Ambalare
471 0054	18 x 1/2"		10/100
471 0044	22 x 1/2"		5/100
471 0062	22 x 3/4"		5/100
471 0055	22 x 1"		5/50



1140
Racord drept cu piulita

Cod	Dimensiune	Pret €	Ambalare
110 0159	15 x 3/4"		5/150

Strangere piulita libera max 1/4 ture
Utilizati garniturile furnizate



1101
Racord drept dublu

i Disponibil si in varianta nichelat

Cod	Dimensiune	Pret €	Ambalare
110 0063	08 x 08		10/100
110 0057	14 x 14		10/100
110 0116	16 x 16		10/100
110 0005	18 x 18		10/100
110 0064	35 x 35		1/25
110 0092	42 x 42		1/25
110 0061	54 x 54		1/10
Redus			
110 0105	10 x 08		10/100
110 0157	15 x 08		10/100
110 0250	16 x 15		10/100
110 0195	18 x 12		10/100
110 0046	18 x 15		10/100
110 0060	22 x 18		5/100
110 0168	35 x 28		1/50



1104
Cot M

i Disponibil si in varianta nichelat

Cod	Dimensiune	Pret €	Ambalare
110 0228	08 x 3/8"		10/100
110 0042	10 x 1/2" ISO7		10/100
110 0175	15 x 3/8" ISO7		10/100
110 0015	15 x 1/2"		10/100
110 0085	15 x 3/4"		5/75
110 0051	18 x 1/2" ISO7		10/100
110 0037	18 x 3/4" ISO7		5/75
110 0068	22 x 1/2"		5/100
110 0020	22 x 3/4"		5/75
110 0038	22 x 1"		5/50
110 0169	28 x 3/4"		5/50
110 0035	28 x 1"		5/50
110 0202	35 x 1"		1/25
110 0074	35 x 1"1/4		1/25
110 0106	42 x 1"1/2		1/25

Până la terminarea stocului



1104FD
Cot de compresie din cupru - M
cu fata plana

Cod	Dimensiune	Pret €	Ambalare
471 0113	15 x 1/2"		10/100
471 0021	15 x 3/4"		5/75
471 0059	16 x 3/4"		5/75
471 0006	18 x 3/4"		5/75
471 0002	22 x 3/4"		5/75
471 0032	22 x 1"		5/50



**1105**
Cot F

i Disponibil si in varianta nichelat

Cod	Dimensiune	Pret €	Ambalare
110 0152	10 x 3/8"		10/100
110 0054	10 x 1/2" ISO7		10/100
110 0111	14 x 1/2"		10/100
110 0138	16 x 1/2"		10/100
110 0041	18 x 1/2" ISO7		10/100
110 0018	18 x 3/4" ISO7		5/75
110 0109	35 x 1"1/4		1/25
110 0128	42 x 1"1/2		1/20
110 0200	54 x 2"		1/10

**1106**
Cot F cu flansa cu 3 gauri

i Disponibil si in varianta nichelat

Cod	Dimensiune	Pret €	Ambalare
110 0065	10 x 1/2"		10/100
110 0043	12 x 1/2"		10/100
110 0149	14 x 1/2"		10/100
110 0004	15 x 1/2"		10/80
110 0208	15 x 3/4"		5/50
110 0180	16 x 1/2"		10/100
110 0091	18 x 1/2"		5/50
110 0142	18 x 3/4"		5/50
110 0137	22 x 1/2"		5/50
110 0084	22 x 3/4"		5/50

**1103**
Cot dublu

i Disponibil si in varianta nichelat

Cod	Dimensiune	Pret €	Ambalare
110 0120	08 x 08		10/100
110 0156	14 x 14		10/100
110 0144	16 x 16		10/100
110 0003	18 x 18		10/100
110 0049	35 x 35		1/25
110 0078	42 x 42		1/20
Redus			
110 0079	18 x 15		10/100
110 0056	22 x 18		5/75

**1133**
Cot dublu tub din cupru/tub Pex

Cod	Dimensiune	Pret €	Ambalare
471 0103	18 (Cu)/18 sp. 2,5 (Pex)		5/100
471 0067	22 (Cu)/18 sp. 2,0 (Pex)		5/100
471 0027	22 (Cu)/18 sp. 2,5 (Pex)		5/100
471 0008	22 (Cu)/22 sp. 3,0 (Pex)		5/100

La cerere

**1141**
Cot cu piulita

Cod	Dimensiune	Pret €	Ambalare
110 0101	15 x 1/2"		10/150

Piulita de strangere max 1/2 ture

Până la terminarea stocului

Nota: A se utiliza garniturile din kit.

**1108**
Teu M

Cod	Dimensiune	Pret €	Ambalare
110 0096	15 x 1/2" x 15		10/100
110 0207	18 x 1/2" x 18		10/50
110 0067	22 x 3/4" x 22		5/50

NOUȚĂȚI

**1108FD**
Teu M fata dreapta

Cod	Dimensiune	Pret €	Ambalare
110 0317	15 x 1/2" x 15		10/100

**1109**
Teu F

 Disponibil si in varianta nichelat

Cod	Dimensiune	Pret €	Ambalare
110 0204	14 x 1/2" x 14		10/100
110 0190	16 x 1/2" x 16		10/90
110 0071	18 x 1/2" ISO7 x 18		5/50
110 0059	18 x 3/4" ISO7 x 18		5/50
110 0174	35 x 1" 1/4 x 35		1/20

**1139**
Teu F

Cod	Dimensiune	Pret €	Ambalare
110 0115	18 x 18 x 1/2"		5/70

**1107**
Teu

1 **2** **3**

 Disponibil si in varianta nichelat

Cod	Dimensiune			Pret €	Ambalare
	1	2	3		
110 0139	08	08	08		10/100
110 0171	14	14	14		10/100
110 0166	16	16	16		10/80
110 0032	18	18	18		5/50
110 0093	35	35	35		1/20
110 0121	42	42	42		1/15
110 0135	54	54	54		1/7
Redus					
110 0192	18	15	15		5/75
110 0104	18	15	18		5/75
110 0216	18	18	15		5/75
110 0209	22	18	18		5/50
110 0146	22	18	22		5/50
110 0224	22	22	18		5/50
110 0237	28	35	28		1/25
110 0213	35	22	35		1/20

Până la terminarea stocului

**1138**
Teu tub din cupru/tub Pex/tub din cupru

1 **2** **3**

Cod	Dimensiune			Pret €	Ambalare
	1	2	3		
471 0037	22 (Cu)	18 x 2,5 (Pex)	22(Cu)		5/50
471 0025	22 (Cu)	22 x 3,0 (Pex)	22(Cu)		5/50

**1110**
Racord cruce

 Disponibil si in varianta nichelat

Cod	Dimensiune	Pret €	Ambalare
110 0217	18 x 18 x 18 x 18		5/50



**1142**

Racord drept dublu cu purjare din teava de cupru/teava de cupru

Cod	Dimensiune	Pret €	Ambalare
110 0221	15 x 15		5/90
110 0222	22 x 22		5/60
110 0242	28 x 28		5/35

Până la terminarea stocului

**1144**

Cot Pentru tub din cupru/M cu purjare

Cod	Dimensiune	Pret €	Ambalare
110 0173	22 x 3/4"		5/60

**1143**

Cot Pentru tub din cupru/teava din cupru cu purjare

Cod	Dimensiune	Pret €	Ambalare
110 0102	22 x 22		5/50

**1145**

Racord de prindere pentru rezervoare

Cod	Dimensiune	Pret €	Ambalare
110 0117	15		10/130
110 0062	22		5/70
110 0113	28		5/50
110 0182	35		1/40
110 0194	42		1/25
110 0164	54		1/20

**1135**

Dop final

 Disponibil si in varianta nichelat

Cod	Dimensiune	Pret €	Ambalare
110 0140	08		10/700
110 0027	18		10/220
110 0133	35		1/50
110 0127	54		1/30

Până la terminarea stocului



1431

Adaptoare pentru tuburi PE-X cu racorduri 1/2"x15

(Set piulita galbena, inel si insertie)

Cod	Dimensiune	Pret €	Ambalare
144 0246	16 x 2,0 - Rif Ø 15		10/200



1631G

Adaptoare pentru tuburi multistrat cu racorduri 1/2"x15 (Set piulita galbena, inel si insertie)

Cod	Dimensiune	Pret €	Ambalare
144 0070	16 x 2,0 - Rif Ø 15		10/200
144 0101	16 x 2,25 - Rif Ø 15		10/200
144 0201	20 x 2,0 - Rif Ø 22		10/350
144 0222	25 x 2,5 - Rif Ø 28		10/150
144 0165	26 x 3,0 - Rif Ø 28		10/150
144 0223	32 x 3,0 - Rif Ø 35		10/100

Furnizat fara piulita
La cerere

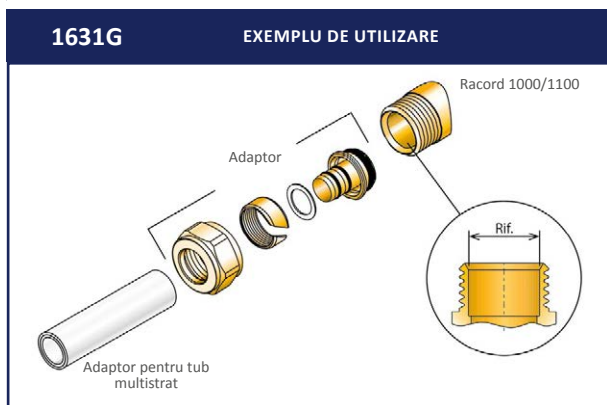

1116

Stut de ranforsare pentru tub din cupru

Cod	Dimensiune	Pret €	Ambalare
110 0227	08 x 1,0		100/3500
110 0033	10 x 1,0		100/3500
110 0028	12 x 1,0		100/2500
110 0050	14 x 1,0		100/1500
110 0014	15 x 1,0		50/1300
110 0097	16 x 1,0		100/1000
110 0240	18 x 0,8		100/800
110 0013	18 x 1,0		100/800
110 0006	22 x 1,0		50/500



1120

Stut de ranforsare pentru teava Pe-x

Cod	Dimensiune	Pret €	Ambalare
110 0123	12 x 2,0		100/2500
110 0029	15 x 2,5		100/2000
110 0126	18 x 2,5		100/1200
110 0073	22 x 3,0		50/700
110 0122	28 x 3,0		50/400
110 0197	28 x 4,0		50/400





1147
Stut reductie

Cod	Dimensiune	Pret €	Ambalare
110 0243	18 x 14		25/750
110 0025	18 x 16		25/750
110 0176	35 x 28		5/130
110 0205	42 x 28		1/120
110 0215	42 x 35		1/120
110 0210	54 x 28		1/60
110 0225	54 x 35		1/60
110 0212	54 x 42		1/60

Până la terminarea stocului



1147CZ
Reductie

Cod	Dimensiune	Pret €	Ambalare
113 0157	12 x 08		25/1300
113 0045	12 x 10		25/1300
113 0202	15 x 08		25/900
113 0062	15 x 10		25/900
113 0026	15 x 12		25/900
113 0079	18 x 12		25/750
113 0018	18 x 15		25/750
113 0083	22 x 12		25/500
113 0028	22 x 15		25/500
113 0022	22 x 18		25/500
113 0152	28 x 15		25/300
113 0067	28 x 22		10/300

1147 - 1147CZ EXEMPLU DE INSTALATIE TIPICA

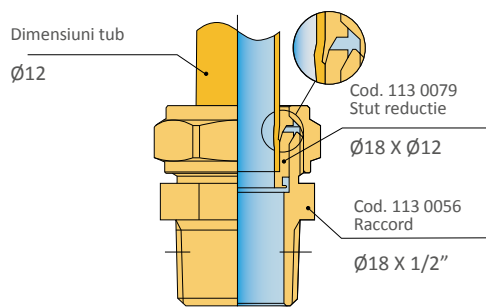

Stuturile de ranforsare 1147 sau 1147CZ sunt indicate doar pentru tevilor de cupru sau pentru cele de inox calibrat; pentru orice alta aplicatie contactati biroul tehnic.

1147 - 1147CZ INSTRUCIUNI PENTRU UN MONTAJ CORECT

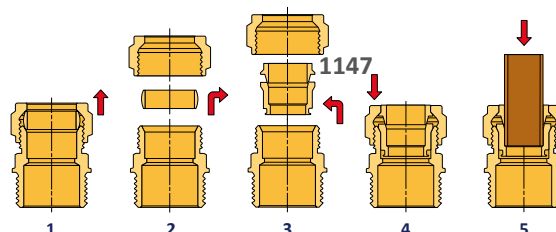

1. Racord de compresie pentru teava de cupru
2. Eliminati inelul de arama
3. Insetati mansonul de ranforsare
4. Strangeti piulita pe racord
5. Introduceti teava si strangeti

OPERATIUNI DE MONTARE PRIN STRANGERE

- Se strange cu mana cat este posibil
- Se strange cu cheia inca ¼ ture pana la pauza de pe inel.
- Se finalizeaza strangerea conform numarului de ture din tabel.

Cod	Pauza	Ture de strans	
113 0157	1/4	min. 1	max. 1 1/4
113 0045	1/4	min. 1	max. 1 1/4
113 0202	1/4	min. 1	max. 1 1/4
113 0062	1/4	min. 1	max. 1 1/4
113 0026	1/4	min. 1 1/4	max. 1 1/2
113 0079	1/4	min. 1	max. 1 1/4
113 0018	1/4	min. 1	max. 1 1/4
113 0083	1/4	min. 1 1/4	max. 1 1/2
113 0028	1/4	min. 1 1/4	max. 1 1/2
113 0022	1/4	min. 1	max. 1 1/4
113 0152	1/4	min. 1	max. 1 1/4
113 0067	1/4	min. 1	max. 1 1/4
110 0243	1/4	min. 1	max. 1 1/4
110 0025	1/4	min. 1	max. 1 1/4
110 0176	1/4	min. 1	max. 1 1/4
110 0205	1/4	min. 3/4	max. 1
110 0215	1/4	min. 3/4	max. 1
110 0210	1/4	min. 3/4	max. 1
110 0225	1/4	min. 3/4	max. 1
110 0212	1/4	min. 3/4	max. 1

Pentru a asigura un montaj mai usor și o etanșare mai bună se recomanda lubrifierea inelelor cu ulei sau unsoare, potrivite pentru apă potabilă, pentru a obtine o deformare omogena.

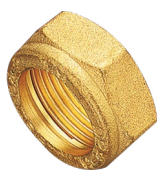

1114
Piulita

 Disponibil si in varianta nichelat

Cod	Dimensiune	Pret €	Ambalare
110 0055	18		50/600
110 0233	35		10/50
110 0226	42		10/50
110 0230	54		10/50

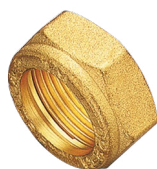

1014
Piulita



 Disponibil si in varianta nichelat

Cod	Dimensiune	Pret €	Ambalare
100 0231	08		100/1500
100 0092	10		100/1500
100 0115	12		100/1500
100 0034	15		50/700
100 0035	22		25/400
100 0055	28		25/250



1115
Inel

Cod	Dimensiune	Pret €	Ambalare
110 0150	08		50/8000
110 0179	14		50/3000
110 0163	16		50/2300
110 0077	18		50/2000
110 0198	35		50/300
110 0218	42		50/200
110 0220	54		10/130

Cupru



1015
Inel



Cod	Dimensiune	Pret €	Ambalare
100 0072	10		50/5000
100 0083	12		50/3000
100 0026	15		50/2000
100 0039	22		50/1200
100 0097	28		50/800



LISTA DE PRETURI

INSTRUCIUNI DE MONTAJ - SERIA 1000/ 1100

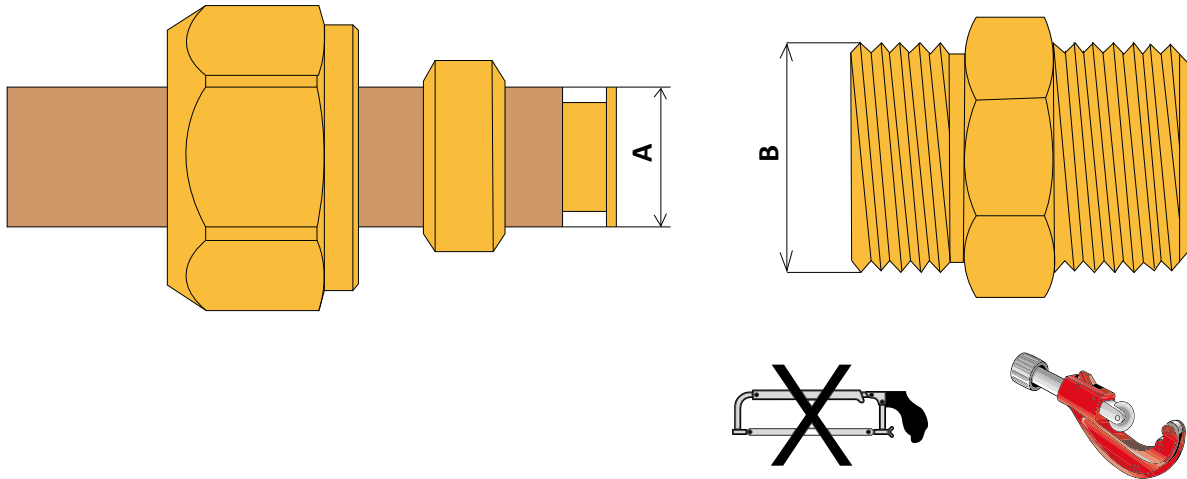
**TAIEREA TUBULUI**

Taierea tevii de cupru se realizeaza cu instrumente speciale, care permit o tăiere fără bavuri și perfect perpendiculara pe axa țevii

DEBAVURAREA SI CURATAREA TEVII

Se debavureaza bine teava si se curata pentru eliminarea eventualelor reziduuri.
La utilizarea tevii de cupru moale utilizati stutul de ranforsare 1116.

MONTAJUL RACORDULUI

Se insereaza piulita si inelul pe teava. Se insurubeaza cu mana cat este posibil apoi in baza dimensiunii a tevii de cupru se strange cu cheia conform tabelului.

Nota: Pentru a asigura un montaj mai usor și o etanșare mai bună se recomanda lubrifierea inelelor cu ulei sau unsoare, potrivite pentru apă potabilă.

TABEL FILETE

A	10	15	18	22	28	35	42	54
B	9/16-24 UNEF-24	G 1/2"	M24 x 1,5	W 1"1/8 x 1/14	W 1"3/8 x 1/14	W 42,06 x 14Tpi	W 49,5 x 11Tpi	W 63,5 x 11Tpi

TABEL DE STRANGERE PIULITE nr ture

A	10	15	18	22	28	35	42	54
Nr ture	1-1/4	1-1/4	1-1/4	1-1/4	1	1	1	1
Cuplu de strangere	15 Nm	70 Nm	85 Nm	110 Nm	125 Nm	225 Nm	390 Nm	560 Nm

Cu **rosu** dimensiunile seriei 1000

07 RACORDURI UNIVERSALE PENTRU CUPRU, PEX SI TUB MULTISTRAT

Seria WATERBLOCK

WATERBLOCK

Racorduri universale pentru cupru, PEX si tub multistrat



136

Racorduri mecanice, de compresie cu adaptori universali pentru conectare pe tuburi pex, tuburi multistrat cu insertie de aluminiu sau tuburi de cupru seria usoara sau seria grea.



GHID DE COMPATIBILITATE

Seria	Tub potrivit	Domeniu de aplicare	Caracteristici tehnice
WATERBLOCK	Cupru	• Apa	Tmax: + 95 °C Pmax: 10 bar
	PE-X "COBRAPEX"	• Apa	Tmax: + 95 °C Pmax: 10 bar
	Multistrat "AL-COBRAPEX"	• Apa	Tmax: + 95 °C Pmax: 10 bar

Pentru detalii suplimentare consultati fisa tehnica



1640GN
Racord drept M

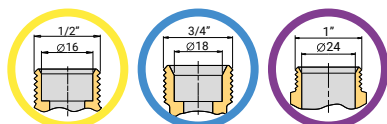

Cod	Dimensiune	Pret €	Ambalare
163 0001	G3/8" - 1/2" (Ø16)		10/500
163 0002	G1/2" - 1/2" (Ø16)		10/350
163 0003	G3/4" - 1/2" (Ø16)		10/250
163 0004	G1/2" - 3/4" (Ø18)		10/250
163 0005	G3/4" - 3/4" (Ø18)		10/200
163 0006	G1" - 3/4" (Ø18)		10/150
163 0007	G3/4" - 1" (Ø24)		10/150
163 0008	G1" - 1" (Ø24)		10/100



1642GN
Racord drept F

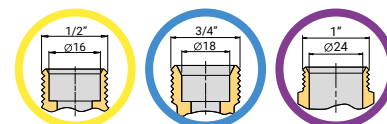

Cod	Dimensiune	Pret €	Ambalare
163 0012	G3/8" - 1/2" (Ø16)		10/400
163 0013	G1/2" - 1/2" (Ø16)		10/300
163 0014	G3/4" - 1/2" (Ø16)		10/200
163 0015	G1/2" - 3/4" (Ø18)		10/250
163 0016	G3/4" - 3/4" (Ø18)		10/200
163 0017	G1" - 3/4" (Ø18)		10/150
163 0018	G3/4" - 1" (Ø24)		10/150
163 0019	G1" - 1" (Ø24)		10/100



1641GN
Racord drept dublu

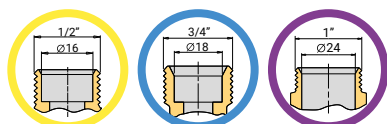

Cod	Dimensiune	Pret €	Ambalare
163 0009	1/2" (Ø16) - 1/2" (Ø16)		10/350
163 0010	3/4" (Ø18) - 3/4" (Ø18)		10/250
163 0011	1" (Ø24) - 1" (Ø24)		10/100



1643GN
Cot dublu

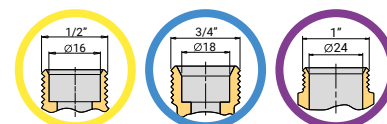

Cod	Dimensiune	Pret €	Ambalare
163 0020	1/2" (Ø16) - 1/2" (Ø16)		10/250
163 0021	3/4" (Ø18) - 3/4" (Ø18)		10/130
163 0022	1" (Ø24) - 1" (Ø24)		10/100

**1644GN**

Cot M

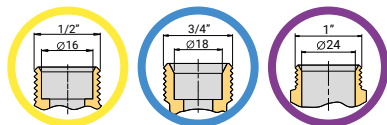

Cod	Dimensiune	Pret €	Ambalare
163 0023	G1/2" - 1/2"(ϕ 16)		10/250
163 0024	G3/4" - 1/2"(ϕ 16)		10/150
163 0025	G1/2" - 3/4"(ϕ 18)		10/150
163 0026	G3/4" - 3/4"(ϕ 18)		10/150
163 0027	G3/4" - 1"(ϕ 24)		10/100
163 0028	G1" - 1"(ϕ 24)		10/100

**1645GN**

Cot F

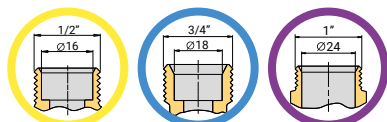

Cod	Dimensiune	Pret €	Ambalare
163 0029	G1/2" - 1/2"(ϕ 16)		10/200
163 0030	G3/4" - 1/2"(ϕ 16)		10/130
163 0031	G1/2" - 3/4"(ϕ 18)		10/150
163 0032	G3/4" - 3/4"(ϕ 18)		10/120
163 0033	G3/4" - 1"(ϕ 24)		10/100
163 0034	G1" - 1"(ϕ 24)		10/100

**1646GN**

Cot F cu flansa

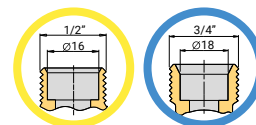

Cod	Dimensiune	Pret €	Ambalare
163 0035	G1/2" - 1/2"(ϕ 16)		10/130
163 0036	G3/4" - 1/2"(ϕ 16)		10/70
163 0037	G1/2" - 3/4"(ϕ 18)		10/80
163 0038	G3/4" - 3/4"(ϕ 18)		10/70

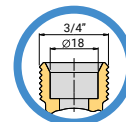
**1649YGN**Racord Y cu piulita si prinderi
3/4" x 18 (Eurocon)

Cod	Dimensiune	Pret €	Ambalare
163 0053	3/4"(ϕ 18) - G 3/4" - 3/4"(ϕ 18)		10/100

**1647GN**

Teu M

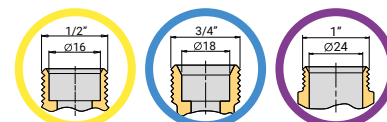

Cod	Dimensiune	Pret €	Ambalare
163 0039	1/2"(ϕ 16) - 1/2"(ϕ 16) - 1/2"(ϕ 16)		10/150
163 0040	3/4"(ϕ 18) - 3/4"(ϕ 18) - 3/4"(ϕ 18)		10/80
163 0041	1"(ϕ 24) - 1"(ϕ 24) - 1"(ϕ 24)		10/50

**1649GN**

Teu F

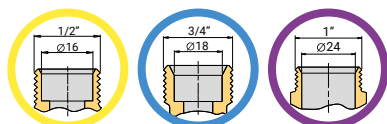

Cod	Dimensiune	Pret €	Ambalare
163 0042	1/2" (Ø16) - G1/2" - 1/2" (Ø16)		10/130
163 0043	3/4" (Ø18) - G1/2" - 3/4" (Ø18)		10/90
163 0044	3/4" (Ø18) - G3/4" - 3/4" (Ø18)		10/70
163 0045	1" (Ø24) - G3/4" - 1" (Ø24)		10/50
163 0046	1" (Ø24) - G1" - 1" (Ø24)		10/50

**1638GN**

Consola cu racorduri finale

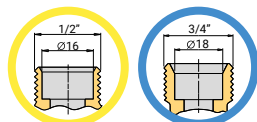

i Interaxe: 100 - 110 - 150 mm

Cod	Dimensiune	Pret €	Ambalare
163 0047	1/2" (Ø16) - G1/2"		1/20
163 0048	3/4" (Ø18) - G1/2"		1/20

**1420K**

Teu F cu racord 24x19fil (Ø18) de utilizat cu 1420P

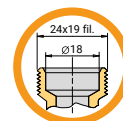

Cod	Dimensiune	Pret €	Ambalare
140 0190	24x19 fil (Ø18) - 1/2" F		10/100

1420K

GHID DE CONEXIUNI

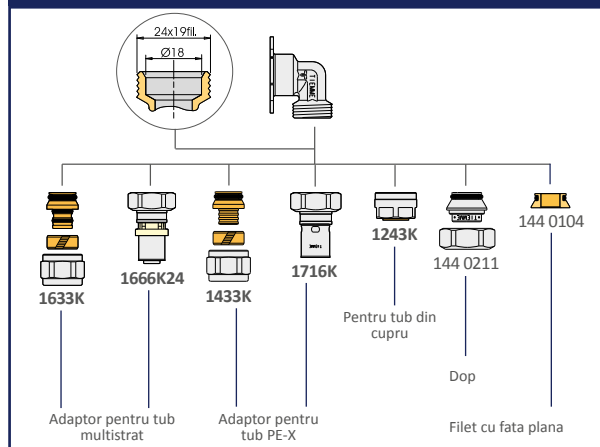
**1420P**

Doza de plastic pentru art. 1420K

Cod	Dimensiune	Pret €	Ambalare
147 0006	Teaca Ø 23 și Ø 27		1/50

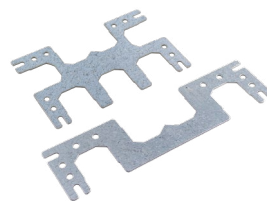
**1420Z**

Suport dublu pentru fixare 1420P

Cod	Interaxe	Pret €	Ambalare
147 0009	38 - 50 - 100		5/50
147 0007	38 - 150		5/50



**1505C04**

Tub de cupru cromat pentru legatura calorifere/alte elemente radiante

Cod	Dimensiune	Pret €	Ambalare
337 0001	Ø15 x 1/2" L=150 mm		2/60

**1481**

Placa pentru cot cu flansa

1646GN

Cod	Dimensiune	Pret €	Ambalare
147 0005	unica		1/100

1420K

EXEMPLU DE UTILIZARE

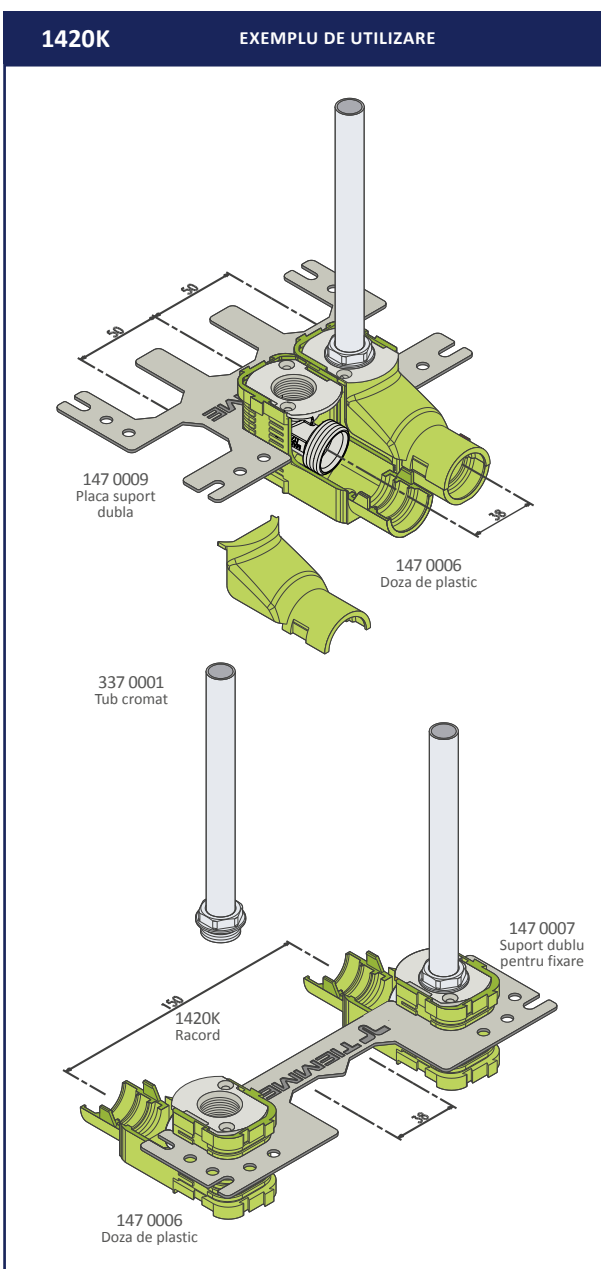

**1435N**

Adaptor pentru conexiuni 1/2"x16. Pentru tub PEX

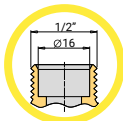

Cod	Dimensiune	Pret €	Ambalare
144 0113	12 x 1,1 - 1/2" (Ø16)		10/350
144 0058	12 x 2,0 - 1/2" (Ø16)		10/350
144 0068	14 x 2,0 - 1/2" (Ø16)		10/350
144 0007	15 x 2,5 - 1/2" (Ø16)		10/350
144 0098	16 x 1,5 - 1/2" (Ø16)		10/350
144 0264	16 x 1,8 - 1/2" (Ø16)		10/300
144 0004	16 x 2,0 - 1/2" (Ø16)		10/300
144 0037	16 x 2,2 - 1/2" (Ø16)		10/300

Până la terminarea stocului

**1635N**

Adaptor pentru conexiuni 1/2"x16. Pentru tub MULTISTRAT

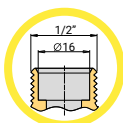

Cod	Dimensiune	Pret €	Ambalare
144 0010	14 x 2,0 - 1/2" (Ø16)		10/350
144 0001	16 x 2,0 - 1/2" (Ø16)		10/300
144 0021	16 x 2,25 - 1/2" (Ø16)		10/300

**1716**

Racord drept cu piulita pentru conexiuni 1/2"x16. Pentru tub PEX

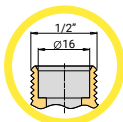

Cod	Dimensiune	Pret €	Ambalare
170 0103	16 x 1,8 - 1/2" (Ø16)		10/100
170 0082	16 x 2,0 - 1/2" (Ø16)		10/100
170 0093	20 x 1,9 e 2,0 - 1/2" (Ø16)		10/100

**1668**

Racord drept cu piulita pentru conexiuni 1/2"x16. Pentru tub MULTISTRAT

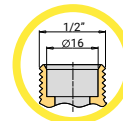

Cod	Dimensiune	Pret €	Ambalare
165 0028	16 - 1/2" (Ø16)		10/100
165 0077	20 - 1/2" (Ø16)		10/100

**1240N**

Piulita si inel de compresie pentru conexiuni 1/2"x16. Pentru tub din CUPRU

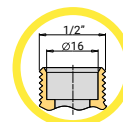

Cod	Dimensiune	Pret €	Ambalare
144 0028	10 - 1/2" (Ø16)		10/400
144 0005	12 - 1/2" (Ø16)		10/400
144 0013	14 - 1/2" (Ø16)		10/400
144 0016	15 - 1/2" (Ø16)		10/400
144 0025	16 - 1/2" (Ø16)		10/400

**1859A16**

Adaptor pentru a transforma un filet 1/2"x16 in filet cu fata plana

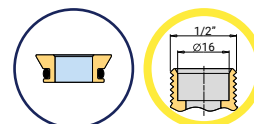

Cod	Dimensiune	Pret €	Ambalare
144 0311	1/2" (Ø16)		10/400

**1879**

Racord terminal

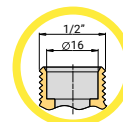

Cod	Dimensiune	Pret €	Ambalare
144 0063	1/2" (Ø16)		10/300

**1436N**

Adaptor pentru conexiuni 3/4"x18 (EUROCONO). Pentru tub PEX

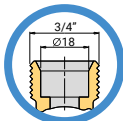

Cod	Dimensiune	Pret €	Ambalare
144 0254	12 x 1,1 - 3/4" (Ø18)		10/250
144 0054	12 x 2,0 - 3/4" (Ø18)		10/250
144 0059	14 x 2,0 - 3/4" (Ø18)		10/250
144 0078	15 x 1,5 - 3/4" (Ø18)		10/250
144 0036	15 x 2,5 - 3/4" (Ø18)		10/250
144 0042	16 x 1,5 - 3/4" (Ø18)		10/250
144 0255	16 x 1,8 - 3/4" (Ø18)		10/250
144 0011	16 x 2,0 - 3/4" (Ø18)		10/250
144 0047	16 x 2,2 - 3/4" (Ø18)		10/250
144 0012	17 x 2,0 - 3/4" (Ø18)		10/200
144 0043	18 x 2,0 - 3/4" (Ø18)		10/200
144 0052	18 x 2,5 - 3/4" (Ø18)		10/200
144 0019	20 x 2,0 - 3/4" (Ø18)		10/200
144 0056	20 x 2,8 - 3/4" (Ø18)		10/200

**1636N**

Adaptor pentru conexiuni 3/4"x18 (EUROCONO). Pentru tub MULTISTRAT

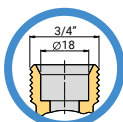

Cod	Dimensiune	Pret €	Ambalare
144 0045	14 x 2,0 - 3/4" (Ø18)		10/250
144 0002	16 x 2,0 - 3/4" (Ø18)		10/250
144 0055	16 x 2,25 - 3/4" (Ø18)		10/250
144 0231	16,2 x 2,6 - 3/4" (Ø18)		10/250
144 0033	17 x 2,0 - 3/4" (Ø18)		10/200
144 0014	18 x 2,0 - 3/4" (Ø18)		10/200
144 0003	20 x 2,0 - 3/4" (Ø18)		10/200
144 0023	20 x 2,25 - 3/4" (Ø18)		10/200
144 0038	20 x 2,5 - 3/4" (Ø18)		10/200

**1716**

Racord drept cu piulita pentru conexiuni 3/4"x18 (EUROCONO). Pentru tub PEX

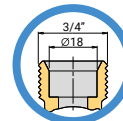

Cod	Dimensiune	Pret €	Ambalare
170 0137	16 x 1,5 - 3/4" (Ø18)		10/100
170 0090	16 x 1,8 - 3/4" (Ø18)		10/100
170 0086	16 x 2,0 - 3/4" (Ø18)		10/100
170 0352	17 x 2,0 - 3/4" (Ø18)		10/100
170 0089	20 x 1,9 e 2,0 - 3/4" (Ø18)		10/100
170 0081	25 x 2,3 - 3/4" (Ø18)		2/100

**1666**

Racord drept cu piulita pentru conexiuni 3/4"x18 (EUROCONO). Pentru tub MULTISTRAT

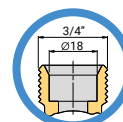

Cod	Dimensiune	Pret €	Ambalare
165 0076	16 - 3/4" (Ø18)		10/100
165 0110	20 - 3/4" (Ø18)		10/100

**1859**

Adaptor pentru a transforma un filet 3/4"x18 (EUROCONO) in filet cu fata plana

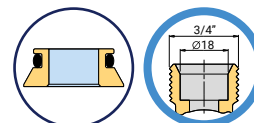

Cod	Dimensiune	Pret €	Ambalare
144 0104	3/4" (Ø18)		10/400

**1241N**

Piulita si inel de compresie pentru conexiuni 3/4"x18 (EUROCONO). Pentru tub din CUPRU

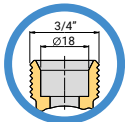

Cod	Dimensiune	Pret €	Ambalare
144 0072	10 - 3/4" (Ø18)		10/250
144 0030	12 - 3/4" (Ø18)		10/250
144 0034	14 - 3/4" (Ø18)		10/250
144 0008	15 - 3/4" (Ø18)		10/250
144 0027	16 - 3/4" (Ø18)		10/250
144 0018	18 - 3/4" (Ø18)		10/250

**1879**

Racord terminal

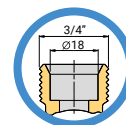

Cod	Dimensiune	Pret €	Ambalare
144 0071	3/4" (Ø18)		10/250

**1636N06**

Adaptor pentru conexiuni 1"x24. Pentru tub MULTISTRAT

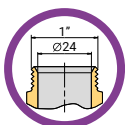

Cod	Dimensiune	Pret €	Ambalare
144 0239	16 x 2,0 - 1" (Ø24)		10/150
144 0240	20 x 2,0 - 1" (Ø24)		10/150
144 0241	26 x 3,0 - 1" (Ø24)		10/150

**1859A24**

Adaptor pentru a transforma un filet 1"x24 in filet cu fata plana

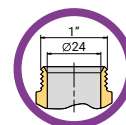

Cod	Dimensiune	Pret €	Ambalare
144 0313	1" (Ø24)		10/300



ADAPTORI PENTRU TUB DE CUPRU - REF. 1240 - 1241

NUMARUL DE ROTATII PENTRU PIULITA					
Ø 10 - 1/2" (Ø16) 1-1/4=10 Nm	Ø 12 - 1/2" (Ø16) 1-1/4=10 Nm	Ø 14 - 1/2" (Ø16) 1-1/4=10 Nm	Ø 15 - 1/2" (Ø16) 1-1/4=12 Nm	Ø 16 - 1/2" (Ø16) 1-1/4=12 Nm	Ø 10 - 3/4" (Ø18) 1-1/4=9 Nm
Ø 12 - 3/4" (Ø18) 1-1/4=9 Nm	Ø 14 - 3/4" (Ø18) 1-1/4=9 Nm	Ø 15 - 3/4" (Ø18) 1-1/4=9 Nm	Ø 16 - 3/4" (Ø18) 1-1/4=12 Nm	Ø 18 - 3/4" (Ø18) 1-1/4=15 Nm	

DACA ESTE NECESAR SE MAI POT APLICA PANA LA 1/4-1/2 ROTATII ULTERIOARE

ADAPTORI PENTRU TUBURI PEX - REF. 1435-1436

NUMARUL DE ROTATII PENTRU PIULITA					
12x1,1 - 1/2" (Ø16) 1=25 Nm	12x2,0 - 1/2" (Ø16) 1=28 Nm	14x2,0 - 1/2" (Ø16) 1=28 Nm	15x2,5 - 1/2" (Ø16) 1=28 Nm	16x1,5 - 1/2" (Ø16) 1=28 Nm	16x1,8 - 1/2" (Ø16) 1=28 Nm
16x2,0 - 1/2" (Ø16) 1=29 Nm	16x2,2 - 1/2" (Ø16) 1=29 Nm	12x1,1 - 3/4" (Ø18) 1=23 Nm	12x2,0 - 3/4" (Ø18) 1=30 Nm	14x2,0 - 3/4" (Ø18) 1=30 Nm	15x1,5 - 3/4" (Ø18) 1=30 Nm
15x2,5 - 3/4" (Ø18) 1=30 Nm	16x1,5 - 3/4" (Ø18) 1=31 Nm	16x2,0 - 3/4" (Ø18) 1=32 Nm	16x2,2 - 3/4" (Ø18) 1=32 Nm	17x2,0 - 3/4" (Ø18) 1=40 Nm	18x2,0 - 3/4" (Ø18) 1=40 Nm
18x2,5 - 3/4" (Ø18) 1=40 Nm	20x2,0 - 3/4" (Ø18) 1=44 Nm	20x2,8 - 3/4" (Ø18) 1=44 Nm			

ADAPTORI PENTRU TUBURI MULTISTRAT AL-COBRAPEX - REF. 1635-1636-1636N06

NUMARUL DE ROTATII PENTRU PIULITA					
14x2,0 - 1/2" (Ø16) 1=28 Nm	16x2,0 - 1/2" (Ø16) 1=30 Nm	16x2,25 - 1/2" (Ø16) 1=30 Nm	14x2,0 - 1/2" (Ø16) 1=30 Nm	16x2,0 - 3/4" (Ø18) 1=33 Nm	16x2,25 - 3/4" (Ø18) 1=33 Nm
17x2,0 - 3/4" (Ø18) 1=40 Nm	18x2,0 - 3/4" (Ø18) 1=40 Nm	20x2,0 - 3/4" (Ø18) 1=45 Nm	20x2,25 - 3/4" (Ø18) 1=45 Nm	20x2,5 - 3/4" (Ø18) 1=45 Nm	16x2,0 - 1" (Ø24) 1=35 Nm
20x2,0 - 1" (Ø24) 1=48 Nm	26x3,0 - 1" (Ø24) 1=53 Nm				

08 TUB MULTISTRAT "AL-COBRAPEX" SI POLIETILENA "COBRAPEX" SI "COBRAPERT"



08A Tub multistrat "AL-COBRAPEX"

Tub multistrat "AL-COBRAPEX"		146
Unelte		149

08B Tub polietilena "COBRAPEX" si "COBRAPERT"

Tub polietilena reticulata "COBRAPEX"		154
Tub din polietilena de inalta densitate cu bariera anti-oxigen "COBRAPEX OXISTOP"		157
Tub din polietilena cu bariera anti-oxigen "COBRAPERT OXISTOP"		158
Unelte		159



0660

Tub multistrat din polietilena reticulata cu insertie de aluminiu
- Culoare alba

Cod	Dim.	Allum.	Pret €/m	Ambalare (m)
060 0001	16 x 2,0	0,20		100/3200
060 0003	20 x 2,0	0,25		100/1800
060 0019	25 x 2,5	0,35		50/1200
060 0007	26 x 3,0	0,35		50/900
060 0014	32 x 3,0	0,40		25/450
060 0064	32 x 3,0	0,40		50/800



0600B 0660B

Tub multistrat din polietilena reticulata cu insertie de aluminiu
- Culoare alba, in bare

Cod	Dim.	Allum.	Pret €/m	Ambalare
060 0026	16 x 2,0	0,20		4 m x 60 pz= 240 m
060 0023	20 x 2,0	0,25		4 m x 40 pz= 160 m
060 0027	25 x 2,5	0,35		4 m x 20 pz= 80 m
060 0025	26 x 3,0	0,35		4 m x 20 pz= 80 m
060 0022	32 x 3,0	0,40		4 m x 15 pz= 60 m
060 0005	40 x 3,5	0,80		4 m x 5 pz= 20 m
060 0009	50 x 4,0	1,00		4 m x 5 pz= 20 m
060 0008	63 x 4,5	1,20		4 m x 3 pz= 12 m
060 0071	75 x 5,0	1,35		5 m x 1 pz= 5 m
060 0073	90 x 7,0	1,35		5 m x 1 pz= 5 m

La cerere



0660S

Tub multistrat din polietilena reticulata cu insertie de aluminiu, fara cutie, ambalat la palet - Culoare alba

Cod	Dim.	Allum.	Pret €/m	Ambalare (m)
060 0067	16 x 2,0	0,20		100/5600
060 0068	16 x 2,0	0,20		200/5600
060 0015	16 x 2,0	0,20		500/6000
060 0070	20 x 2,0	0,25		100/3200
060 0072	26 x 3,0	0,35		50/1200

Se vinde doar ambalat la palet



0630B

Tub multistrat din polietilena reticulata cu insertie de aluminiu imbracat in izolatie albastra

Cod	Dim.	Allum.	Grosime	Pret €/m	Ambalare (m)
062 0004	16 x 2,0	0,20	6 mm		50/850
062 0014	16 x 2,0	0,20	6 mm		100/1100
062 0006	20 x 2,0	0,25	6 mm		50/700
062 0026	25 x 2,5	0,35	6 mm		50/500
062 0005	26 x 3,0	0,35	6 mm		50/500
062 0022	32 x 3,0	0,40	6 mm		25/250



0630R

Tub multistrat din polietilena reticulata cu insertie de aluminiu imbracat in izolatie rosie

Cod	Dim.	Allum.	Grosime	Pret €/m	Ambalare (m)
062 0001	16 x 2,0	0,20	6 mm		50/850
062 0009	16 x 2,0	0,20	6 mm		100/1100
062 0003	20 x 2,0	0,25	6 mm		50/700
062 0025	25 x 2,5	0,35	6 mm		50/500
062 0002	26 x 3,0	0,35	6 mm		50/500
062 0010	32 x 3,0	0,40	6 mm		25/250



0635

Tub multistrat din polietilena reticulata cu insertie de aluminiu imbracat in izolatia verde pentru climatizare

Cod	Dim.	Allum.	Grosime	Pret €/m	Ambalare (m)
062 0019	16 x 2,0	0,20	10 mm		50/500
062 0008	20 x 2,0	0,25	10 mm		50/450
062 0015	26 x 3,0	0,35	10 mm		25/250
062 0075	32 x 3,0	0,40	10 mm		25/250



0636

Tub multistrat 0660 imbracat in izolatia gri pentru climatizare (Euroclase BL-s1-d0)

Cod	Dim.	Allum.	Grosime	Pret €/m	Ambalare (m)
062 0086	16 x 2,0	0,20	10 mm		50/500
062 0087	20 x 2,0	0,25	13 mm		50/400
062 0088	26 x 3,0	0,35	13 mm		25/225
062 0089	32 x 3,0	0,40	13 mm		25/200



0640B

Tub multistrat din polietilena reticulata cu insertie de aluminiu in teaca ondulata de culoare albastra

Cod	Dimensiune	Allum.	Pret €/m	Ambalare (m)
064 0001	16 x 2,0	0,20		50/1350
064 0004	16 x 2,0	0,20		100/1200
064 0003	20 x 2,0	0,25		50/1350



0640R

Tub multistrat din polietilena reticulata cu insertie de aluminiu in teaca ondulata de culoare rosie

Cod	Dimensiune	Allum.	Pret €/m	Ambalare (m)
064 0002	16 x 2,0	0,20		50/1350
064 0005	16 x 2,0	0,20		100/1200
064 0006	20 x 2,0	0,25		50/1350



0641

Tub multistrat 0660 AL-COBRAPEX TWIN cu teaca ondulata gri

Cod	Dimensiune	Allum.	Pret €/m	Ambalare (m)
064 0019	16 x 2,0	0,20		50/1200
064 0020	20 x 2,0	0,25		50/700



0900B

Teaca ondulata de protectie de culoare albastra, pentru trecerea tubului prin profilul de dilatare

Cod	Dimensiune	Pret €/m	Ambalare (m)
090 0004	∅ int.=19 mm		100/2800
090 0010	∅ int.=23 mm		50/1400
090 0003	∅ int.=23 mm		100/2800
090 0008	∅ int.=28 mm		50/1000



0900R

Teaca ondulata de protectie de culoare rosie, pentru trecerea tubului prin profilul de dilatare

Cod	Dimensiune	Pret €/m	Ambalare (m)
090 0005	∅ int.=19 mm		100/2800
090 0001	∅ int.=23 mm		50 /1400
090 0002	∅ int.=23 mm		100/2800
090 0007	∅ int.=28 mm		50/1000



0625

Dispozitiv de etansare din PVC transparent pentru protejarea tevii

Cod	Dimensiune	Pret €	Ambalare
060 0034	12		10/250
060 0046	14		10/250
060 0036	16		10/250
060 0038	18		10/250
060 0037	20		10/250

GHID DE SELECTARE A FITINGURILOR TIEMME

Fitinguri de compresie pentru teava multistrat "AL-COBRAPEX" - seria 1600

Cap. 02



Fitinguri prin presare pentru teava multistrat "AL-COBRAPEX" - seria 1650

Cap. 03A





1699
Instrument de montare a
mansonului din oțel inoxidabil

Cod	Dimensiune	Pret €	Ambalare
159 0056	16		1/25
159 0054	20		1/25
159 0055	26		1/20
159 0053	32		1/10
159 0057	40		1/10
159 0120	50		1/5
159 0121	63		1/5

1699

EXEMPLU DE UTILIZARE

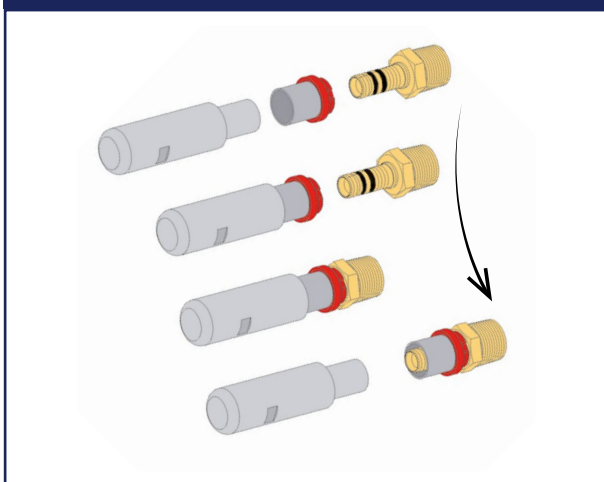

1495
Foaie pentru tuburi

Cod	Dimensiune	Pret €	Ambalare
034 0015	0 - 35		1/5

Lama de rezerva disponibila cod. 159 0066



1496
Foaie pentru tuburi

Cod	Dimensiune	Pret €	Ambalare
034 0030	14 - 16 - 18 - 20		1/1



1683
Foaie circulară pentru tuburi
prevăzută cu mini debavurator

Cod	Dimensiune	Pret €	Ambalare
034 0032	0 - 32		1/12
034 0034	0 - 67		1/6
034 0083	50-127		1/3



1682
Debavurator

Cod	Dimensiune	Pret €	Ambalare
034 0026	unica		1/15



4530
Derulator teava

Cod	Dimensiune	Pret €	Ambalare
450 0028	-		1/1



1689
Trusa indreptat tevi

Cod	Dimensiune	Pret €	Ambalare
034 0004	14 - 26		1/1



1684
Echipament pentru îndoit țevi Al-Cobrapex

Cod	Dimensiune	Pret €	Ambalare
034 0016	16 - 32		1/1



1497
1497EST
Arc de indoit tub

Cod	Dimensiune	Pret €	Ambalare
Pentru interiorul tubului L = 100 cm			
034 0001	16		1/50
034 0007	20		1/50
034 0020	25 - 26		1/20
Pentru interiorul tubului L = 50 cm			
034 0002	16		1/20
034 0005	20		1/20
034 0080	26		1/20



1498SET
Trusa debavurator completa

i Conține maner interschimbabil si accesorii

Cod	Dimensiune	Pret €	Ambalare
034 0018	14 ÷ 40		1/1
034 0011	16 - 20 - 25 - 26		1/1

Ø14x2,0 - Ø16x2,0 - Ø18x2,0 - Ø20x2,0 - Ø25x2,5 - Ø26x3,0 - Ø32x3,0 - Ø40x3,5



1498UM
Debavurator cu maner in forma de "T"

Cod	Dimensiune	Pret €	Ambalare
034 0006	16 x 2,0		1/1
034 0008	20 x 2,0		1/1
034 0009	25 x 2,5 - 26 x 3,0		1/1
034 0014	32 x 3,0		1/1



1498MT
Maner interschimbabil in forma de "T"

i De utilizat cu 1498US pentru operatiuni manuale

Cod	Dimensiune	Pret €	Ambalare
034 0017	-		1/1



1498US
Debavurator interschimbabil

Cod	Dimensiune	Pret €	Ambalare
034 0021	16 x 2,0		1/100
034 0023	20 x 2,0		1/100
034 0024	25 x 2,5 - 26 x 3,0		1/100
034 0027	32 x 3,0		1/100
034 0025	40 x 3,5		1/100
034 0028	50 x 4,0		1/100
034 0031	63 x 4,5		1/100

De utilizat cu 1498MT pentru operatiuni manuale sau cu bormasina

De utilizat cu cheie tubulara hexagonala de 10





1695TM01

Presă cu baterie TIEMME (standard) pentru tub de la 16 la 90 inclusiv 90

i Presă se livrează într-o cutie ce conține: baterie reincarcabila Li-Ion 18Vdc - 2,0 Ah; încărcător de baterie; set de clești (dacă este prevăzut) Ø 16, 20, 26

Cod	Set capete presare	Pret €	Ambalare
159 0085	Nu sunt incluse		1/1
159 0086	16 - 20 - 26		1/1



1695TM02

Presă cu baterie TIEMME (MINI) pentru tub de la 16 la 32 inclusiv 32

i Presă se livrează într-o cutie ce conține: baterie reincarcabila Li-Ion 18Vdc - 2,0 Ah; încărcător de baterie.

Cod	Set capete presare	Pret €	Ambalare
159 0106	Nu sunt incluse		1/1



1695TM03

Presă cu baterie TIEMME (MINI) pentru tub de la 16 la 32 inclusiv 32

i Presă se livrează într-o cutie ce conține: baterie reincarcabila Li-Ion 18Vdc - 2,0 Ah; încărcător de baterie; set de clești (dacă este prevăzut) Ø 16, 20, 26

Cod	Set capete presare	Pret €	Ambalare
159 0089	Nu sunt incluse		1/1
159 0090	16 - 20 - 26		1/1



1695TM01B

Baterie Li-Ion 18Vdc / 2,0 Ah pentru presa 1695TM01

Cod	Dimensiune	Pret €	Ambalare
159 0087	18Vdc/2,0 Ah		1/1



1695TM02B

Baterie Li-ION pentru presa TIEMME (MINI)

Cod	Set capete presare	Pret €	Ambalare
159 0110	18Vdc/2,0 Ah		1/1



1695TM03B

Baterie Li-ION 12Vdc / 2 Ah pentru presa TIEMME (MINI) 1695TM03

Cod	Dimensiune	Pret €	Ambalare
159 0091	12Vdc/2,0 Ah		1/1



1695TM01C

Încărcător baterie Li-ION pentru presa TIEMME (standard)

Cod	Dimensiune	Pret €	Ambalare
159 0088	230 Vac		1/1



1695TM02C

Încărcător baterie Li-ION pentru presa TIEMME (MINI)

Cod	Dimensiune	Pret €	Ambalare
159 0111	230 Vac		1/1



1695TM03C

Încărcător de baterie pentru 1695TM03B

Cod	Dimensiune	Pret €	Ambalare
159 0092	230 Vac		1/1



1681

Capete de presare - TH PROFILE
- personalizat TIEMME

Cod	Dimensiune	Pret €	Ambalare
159 0005	16		1/1
159 0004	20		1/1
159 0030	25		1/1
159 0006	26		1/1
159 0001	32		1/1
159 0010	40		1/1
159 0008	50		1/1
159 0012	63		1/1
159 0123	75		1/1
159 0101	75		1/1
159 0117	90		1/1

Capete de presare cu 3 sectoare

Capete de presare cu 3 sectoare pentru profil U pentru 165 1256 si 165 1267

Capete de presare cu 4 sectoare

Capete de presare 4 sectoare pentru profil U



1681MINI

Capete de presare - TH PROFILE
- personalizat TIEMME pentru
presa MINI

Cod	Dimensiune	Pret €	Ambalare
159 0025	16		1/1
159 0027	20		1/1
159 0024	25		1/1
159 0036	26		1/1
159 0028	32		1/1

DIMENSIUNI DE GABARIT PENTRU CAPETELE DE PRESARE

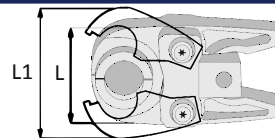

Cod	Dimensiune	L (mm)	L1 (mm)
159 0005	16	101	104
159 0004	20	101	104
159 0030	25	101	115
159 0006	26	101	115
159 0001	32	101	115
159 0010	40	101	120
159 0008	50	165	175
159 0012	63	175	185
159 0123	75	140	-
159 0101	75	140	-
159 0117	90	160	200
159 0025	16	101	101
159 0027	20	101	101
159 0024	25	101	108
159 0036	26	101	108
159 0028	32	101	108

L=falcile in pozitia inchis
L1=falcile in pozitia deschis

INSTRUCȚIUNI PENTRU PREGĂTIREA TUBULUI

Pentru a obține o îmbinare perfectă, indiferent de tipul de fitting care va fi folosit ulterior, trebuie efectuate câteva operații simple, dar importante pentru pregătirea țevii.

- Mai întâi trebuie să tăiați tubul la dimensiunea dorită. Pentru a efectua tăierea este indicat să folosiți un tăietor de țevi sau foarfeca adecvată, asigurându-vă că tăierea este cât mai perpendiculară pe axa țevii în (Fig.1).
- Apoi se procedează la debavurarea și calibrarea țevii cu ajutorul instrumentului indicat în Fig. 2. Debavuratorul este introdus în țevă și apoi rotit în sensul acelor de ceasornic.

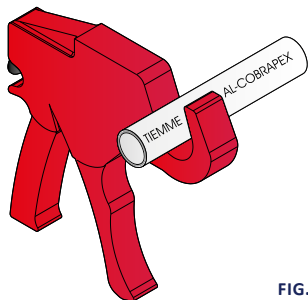

FIG. 1

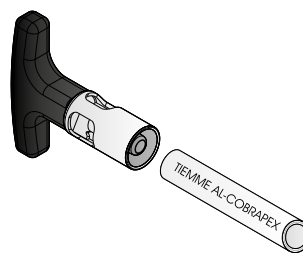

FIG. 2



0300B

Tub din polietilena reticulata de inalta densitate - de culoare alba

i De culoare tub

i La cerere, colacii pot fi de lungime 120 -200 m (Până la Ø 20 mm)

Cod	Dimensiune	Pret €/m	Ambalare (m)
030 0001	16 x 2,0		100/3000
030 0222	16 x 2,0		300/3600
030 0002	16 x 2,2		100/3000
999 0060	17 x 2,0		100/1800
030 0005	20 x 2,0		100/1800
030 0013	25 x 2,3		50/1350
030 0021	32 x 2,9		50/750
030 0028	40 x 3,7		50/500
030 0029	50 x 4,6		50/350
030 0030	63 x 5,8		50/350

Pentru racorduri vezi Cap. 09

Pana la terminarea stocului



0330B

Tub Pex imbracat in izolatia albastra

i De culoare tub
Culoare izolatia

Cod	Dim.	Izolatie	Pret €/m	Ambalare (m)
033 0004	16 x 2,0	6 mm		100/1300
033 0003	20 x 2,0	6 mm		100/1200
033 0009	25 x 2,3	6 mm		50/500



0300BB

Tub din polietilena reticulata de inalta densitate - de culoare alba in bare

i De culoare tub

Cod	Dimensiune	Pret €/m	Ambalare
030 0147	16 x 2,0		4 m x 10 pz= 40m
030 0148	16 x 2,2		4 m x 10 pz= 40m
030 0154	20 x 2,0		4 m x 10 pz= 40m
030 0157	25 x 2,3		4 m x 10 pz= 40m
030 0160	32 x 2,9		4 m x 10 pz= 40m
030 0163	40 x 3,7		4 m x 10 pz= 40m
030 0164	50 x 4,6		4 m x 5 pz= 20m
030 0165	63 x 5,8		4 m x 4 pz= 16m

Pentru racorduri vezi Cap. 09



0330R

Tub Pex imbracat in izolatia rosie

i De culoare tub
Culoare izolatia

Cod	Dim.	Izolatie	Pret €/m	Ambalare (m)
033 0001	16 x 2,0	6 mm		100/1300
033 0002	20 x 2,0	6 mm		100/1200
033 0006	25 x 2,3	6 mm		50/500



0300N

Tub din polietilena reticulata de inalta densitate - de culoare neagra

i De culoare tub ■

i La cerere, colacii pot fi de lungime 120 -200 m (Până la Ø 20 mm)

Cod	Dimensiune	Pret €/m	Ambalare (m)
030 0004	16 x 2,0		100/3000
030 0017	16 x 2,2		100/3000
030 0042	20 x 2,0		100/1800
030 0072	25 x 2,3		50/1350
030 0223	32 x 2,9		50/750
030 0034	40 x 3,7		50/500
030 0036	50 x 4,6		50/350
030 0041	63 x 5,8		50/350

Pentru racorduri vezi Cap. 09



0300BL

Tub din polietilena reticulata de inalta densitate - de culoare albastra

i De culoare tub ■

Cod	Dimensiune	Pret €/m	Ambalare (m)
030 0245	16 x 2,0		100/3000
030 0264	16 x 2,0		200/3600
030 0246	20 x 2,0		100/1800
030 0218	25 x 2,3		50/1350
030 0219	32 x 2,9		50/750



0300R

Tub din polietilena reticulata de inalta densitate - de culoare rosie

i De culoare tub ■

Cod	Dimensiune	Pret €/m	Ambalare (m)
030 0207	16 x 2,0		300/2700
030 0225	16 x 2,0		600/3000
030 0202	16 x 2,0		500/1500
030 0237	20 x 2,0		300/2400
030 0238	20 x 2,0		500/2500
030 0247	25 x 2,3		50/1350
030 0214	32 x 2,9		50/750

08_B TUB DIN POLIETILENA RETICULATA "COBRAPEX"

Flexibilitate inalta pentru instalatii substituibile – protectie gofrata



0800B

Tub Pex in teacă ondulata albastra

i De culoare tub
Culoare teacă

Cod	Dim.	Ø ext. teacă	Pret €/m	Ambalare (m)
080 0009	16 x 2,0	24		50/1350
080 0019	16 x 2,0	28		50/1350
080 0010	16 x 2,2	24		50/1350
080 0030	20 x 2,0	28		50/1350
080 0051	25 x 2,3	33		50/750



0800R

Tub Pex in teacă ondulata rosie

i De culoare tub
Culoare teacă

Cod	Dim.	Ø ext. teacă	Pret €/m	Ambalare (m)
080 0006	16 x 2,0	24		50/1350
080 0024	16 x 2,0	28		50/1350
080 0014	16 x 2,2	24		50/1350
080 0028	20 x 2,0	28		50/1350
080 0054	25 x 2,3	33		50/750



0810B

Tub Pex negru in teaca ondulata albastra

i De culoare tub
Culoare teacă

Cod	Dim.	Ø ext. teacă	Pret €/m	Ambalare (m)
080 0002	16 x 2,0	24		50/1350
080 0001	16 x 2,0	28		50/1350
080 0044	20 x 2,0	28		50/1350



0810R

Tub Pex negru in teaca ondulata rosie

i De culoare tub
Culoare teacă

Cod	Dim.	Ø ext. teacă	Pret €/m	Ambalare (m)
080 0004	16 x 2,0	24		50/1350
080 0003	16 x 2,0	28		50/1350
080 0042	20 x 2,0	28		50/1350





0200B

Tub din polietilena reticulata de inalta densitate cu bariera oxigen - culoare alba

i De culoare tub

i La cerere pot fi furnizate si la alte lungimi

Cod	Dimensiune	Pret €/m	Ambalare (m)
020 0005	16 x 2,0		120/3240
020 0018	16 x 2,0		200/3600
020 0003	16 x 2,0		300/2700
020 0001	16 x 2,0		600/3000
020 0008	17 x 2,0		120/3240
020 0071	17 x 2,0		200/3200
020 0006	17 x 2,0		300/2400
020 0002	17 x 2,0		600/2400
020 0011	20 x 2,0		120/2160
020 0012	20 x 2,0		300/2400
020 0004	20 x 2,0		500/2500
020 0146	25 x 2,3		50/1350
020 0009	25 x 2,3		300/1500
020 0059	32 x 2,9		50/750



0200R

Tub din polietilena reticulata de inalta densitate cu bariera oxigen - culoare rosie

i De culoare tub

Cod	Dimensiune	Pret €/m	Ambalare (m)
020 0074	16 x 2,0		300/2700
020 0090	16 x 2,0		600/3000
020 0128	17 x 2,0		600/3000
020 0104	20 x 2,0		300/2400
020 0079	25 x 2,3		50/1350



0230B

Tub Pex cu bariera oxigen imbracat in izolatie albastra

i De culoare tub
Culoare izolatie

Cod	Dimensiune	Izolatie	Pret €/m	Ambalare (m)
023 0001	16 x 2,0	6 mm		100/1300

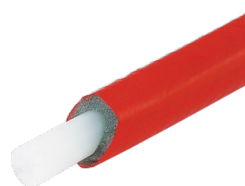

0230R

Tub Pex cu bariera oxigen imbracat in izolatie rosie

i De culoare tub
Culoare izolatie

Cod	Dimensiune	Izolatie	Pret €/m	Ambalare (m)
023 0002	16 x 2,0	6 mm		100/1300

08_B TUB DIN POLIETILENA DE INALTA DENSITATE CU BARIERA ANTI-OXIGEN "COBRAPEX OXISTOP"

Flexibilitate inalta pentru instalatii substituibile – protectie gofrata



0805B

Tub Pex cu bariera oxigen in teacă ondulata albastra

i De culoare tub
Culoare teacă

Cod	Dim.	Ø ext. teacă	Pret €/m	Ambalare (m)
024 0003	16 x 2,0	28		50/1350
024 0002	16 x 2,0	24,5		100/1600



0805R

Tub Pex cu bariera oxigen in teacă ondulata rosie

i De culoare tub
Culoare teacă

Cod	Dim.	Ø ext. teacă	Pret €/m	Ambalare (m)
024 0004	16 x 2,0	28		50/1350
024 0001	16 x 2,0	24,5		100/1600



0900B

Teacă ondulata de protectie de culoare albastra, pentru trecerea tubului prin profilul de dilatare

Cod	Dimensiune	Pret €/m	Ambalare (m)
090 0004	Ø int.=19 mm		100/2800
090 0010	Ø int.=23 mm		50/1400
090 0003	Ø int.=23 mm		100/2800
090 0008	Ø int.=28 mm		50/1000



0900R

Teacă ondulata de protectie de culoare rosie, pentru trecerea tubului prin profilul de dilatare

Cod	Dimensiune	Pret €/m	Ambalare (m)
090 0005	Ø int.=19 mm		100/2800
090 0001	Ø int.=23 mm		50/1400
090 0002	Ø int.=23 mm		100 /2800
090 0007	Ø int.=28 mm		50/1000

08_B TUB DIN POLIETILENA CU BARIERA ANTI-OXIGEN "COBRAPERT OXISTOP"

PE-RT Type II (polietilena rezistenta la temperaturi ridicate)



0210R

Tub din polietilena rezistenta la temperaturi ridicate COBRAPERT cu bariera oxigen (EVOH). Culoare rosie.

i De culoare tub

Cod	Dimensiune	Pret €/m	Ambalare (m)
021 0004	16 x 2,0		300/2700
021 0003	16 x 2,0		600/3000
021 0011	17 x 2,0		300/2400
021 0013	17 x 2,0		120/3840
021 0005	17 x 2,0		600/3000
021 0010	20 x 2,0		300/1800
021 0006	20 x 2,0		500/3000



LISTA DE PRETURI



1480P

Cot la 90° din plastic pentru protecția și susținerea tubului „COBRAPEX” în apropierea racordului la colectorul de distribuție

Cod	Dimensiune	Pret €	Ambalare
034 0076	10 - 12		50/300
034 0077	16 - 18		25/500
034 0078	20 - 22		25/100
034 0079	25		25/150



4530

Derulator teava

Cod	Dimensiune	Pret €	Ambalare
450 0028	-		1/1



1495

Foarfecă pentru tuburi

Cod	Dimensiune	Pret €	Ambalare
034 0015	0 - 35		1/5

Lama de rezerva disponibilă cod. 159 0066



1495R63

Foarfecă pentru tuburi

Cod	Dimensiune	Pret €	Ambalare
034 0036	0-63		1/1

Lama de rezerva disponibilă cod. 159 0067



1496R42

Foarfecă pentru tuburi

Cod	Dimensiune	Pret €	Ambalare
034 0022	0 - 42		1/10



1496

Foarfecă pentru tuburi

Cod	Dimensiune	Pret €	Ambalare
034 0030	14 - 16 - 18 - 20		1/1

GHID PENTRU ALEGEREA RACORDURILOR TIEMME

Fitinguri de compresie pentru teava Pex „COBRAPEX” - seria 1400

Cap. 4



Fitinguri pentru țevi Pex „COBRAPEX” - seria 1700

Cap. 5



INSTRUCIUNI PENTRU TAIEREA TUBULUI

Pentru a obține o îmbinare perfectă, indiferent de tipul de fitting care va fi folosit ulterior, trebuie efectuate câteva operații simple, dar importante pentru pregătirea țevii.

- Continuați să tăiați tubul la dimensiunea dorită. Pentru a efectua tăierea este indicat să folosiți un tăietor de țevi sau foarfeca adecvată, asigurându-vă că tăierea este cât mai perpendiculară pe axa țevii în sine (Fig.1).

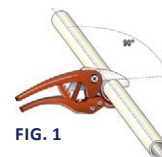

FIG. 1



1681RF

Capete de presare - RF profile - personalizat TIEMME

i Pentru accesorii vezi Cap. 08A

Cod	Dimensiune	Pret €	Ambalare
159 0095	12		1/1
159 0038	16		1/1
159 0129	17		1/1
159 0051	18		1/1
159 0039	20		1/1
159 0040	25		1/1
159 0042	32		1/1



1681MINIRF

Capete de presare - RF profile - personalizat TIEMME pentru presa MINI

i Pentru accesorii vezi Cap. 08A

Cod	Dimensiune	Pret €	Ambalare
159 0094	12		1/1
159 0032	16		1/1
159 0130	17		1/1
159 0052	18		1/1
159 0029	20		1/1
159 0033	25		1/1
159 0035	32		1/1

DIMENSIUNI DE GABARIT PENTRU CAPETELE DE PRESARE

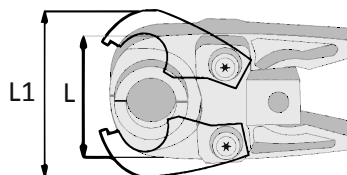

Cod	Dimensiune	L (mm)	L1 (mm)
159 0095	12	101	104
159 0038	16	101	104
159 0129	17	101	104
159 0051	18	101	104
159 0039	20	101	104
159 0040	25	101	115
159 0042	32	101	115
159 0094	12	101	101
159 0032	16	101	101
159 0130	17	101	101
159 0052	18	101	101
159 0029	20	101	101
159 0033	25	101	108
159 0035	32	101	108

L=falcile in pozitia inchis
L1=falcile in pozitia deschis



09 RACORDURI DE COMPRESIE CU O-RING DIN ALAMA PENTRU TUBURI DIN PE/PEHD/PEX

Seria 3460

3460W
Racorduri de compresie cu o-ring pentru tuburi PE/PEHD/PEX - COMPACT  162

3460CR
Racorduri de compresie cu o-ring pentru tuburi PE/PEHD/PEX  165

1460
Fitinguri de compresie cu o-ring-uri pentru tevi PE / PEHD / PEX de diametru mare  168

Accesorii  169

GHID DE COMPATIBILITATE

Seria	Tub potrivit	Stut de ranforsare obligatorie	Domeniu de aplicare	Caracteristici tehnice
3460W 3460CR	PE / PE-HD / PEX	-	• Apa rece	Pmax: 30 bar
3460W 3460CR	PE / PE-HD / PEX	Art. 1475	• Apa calda	Tmax: + 110 °C Pmax: 30 bar
1460	PE / PE-HD / PEX	-	• Apa rece	Pmax: 25 bar
1460	PE / PE-HD / PEX	Art. 1475	• Apa calda	Tmax: + 110 °C Pmax: 25 bar
3460CR	PE-HD	Art. 1475	• Gaz	Tmax: + 110 °C MOP5
3460W 3460CR 1460	Multistrat "AL-COBRAPEX"	Art. 1476	• Apa rece • Apa calda	Tmax: + 95 °C Pmax: 10 bar

Pentru detalii suplimentare consultati fisa tehnica



3460W



3460W
Racord drept M ISO 228

Cod	Dimensiune	Pret €	Ambalare
341 0013	20 x 1/2"		5/100
341 0003	25 x 3/4"		5/75
341 0001	32 x 1"		5/25
341 0079	32 x 1"1/4		5/25
341 0006	40 x 1"1/4		2/20
341 0067	40 x 1"1/2		2/20
341 0040	50 x 1"1/2		2/10
341 0038	63 x 2"		1/10



3462W
Racord drept F ISO 228

Cod	Dimensiune	Pret €	Ambalare
341 0019	20 x 1/2"		5/100
341 0011	25 x 3/4"		5/50
341 0004	32 x 1"		5/25
341 0015	40 x 1"1/4		2/20
341 0068	40 x 1"1/2		2/20
341 0039	50 x 1"1/2		2/10
341 0037	63 x 2"		2/10



3461W
Racord drept dublu

Cod	Dimensiune	Pret €	Ambalare
341 0021	20 x 20		5/50
341 0008	25 x 25		5/25
341 0005	32 x 32		5/25
341 0016	40 x 40		2/10
341 0041	50 x 50		2/10
341 0042	63 x 63		2/10



3464W
Cot M conic ISO 228

Cod	Dimensiune	Pret €	Ambalare
341 0027	20 x 1/2"		5/75
341 0020	25 x 3/4"		5/50
341 0007	32 x 1"		5/25
341 0031	40 x 1"1/4		2/10
341 0045	50 x 1"1/2		2/10
341 0046	63 x 2"		1/5



3465W
Cot F ISO 228

Cod	Dimensiune	Pret €	Ambalare
341 0029	20 x 1/2"		5/50
341 0017	25 x 3/4"		5/50
341 0009	32 x 1"		5/25
341 0026	40 x 1"1/4		2/10
341 0047	50 x 1"1/2		2/10
341 0048	63 x 2"		1/5



3463W
Cot dublu

Cod	Dimensiune	Pret €	Ambalare
341 0023	20 x 20		5/50
341 0014	25 x 25		5/25
341 0002	32 x 32		5/20
341 0010	40 x 40		2/10
341 0043	50 x 50		2/10
341 0044	63 x 63		1/5



3460W

**3468W**

Teu M ISO 228

Cod	Dimensiune	Pret €	Ambalare
341 0034	20 x 1/2" x 20		5/50
341 0033	25 x 3/4" x 25		5/25
341 0035	32 x 1" x 32		5/15
341 0036	40 x 1"1/4 x 40		2/10
341 0051	50 x 1"1/2 x 50		2/10
341 0052	63 x 2" x 63		1/5

**3469W**

Teu F ISO 228

Cod	Dimensiune	Pret €	Ambalare
341 0030	20 x 1/2" x 20		5/25
341 0028	25 x 3/4" x 25		5/25
341 0024	32 x 1" x 32		5/15
341 0032	40 x 1"1/4 x 40		2/8
341 0053	50 x 1"1/2 x 50		2/10
341 0054	63 x 2" x 63		1/5

**3467W**

Teu

Cod	Dimensiune	Pret €	Ambalare
341 0025	20 x 20 x 20		5/25
341 0018	25 x 25 x 25		5/20
341 0012	32 x 32 x 32		5/10
341 0022	40 x 40 x 40		2/6
341 0049	50 x 50 x 50		2/10
341 0050	63 x 63 x 63		1/5

**3472W**

Piulita

Cod	Dimensiune	Pret €	Ambalare
341 0055	20		25/400
341 0056	25		25/300
341 0057	32		25/250
341 0058	40		10/200
341 0059	50		10/100
341 0060	63		5/50

**3473W**

Inel de etansare

Cod	Dimensiune	Pret €	Ambalare
341 0061	20		50/1200
341 0062	25		50/800
341 0063	32		50/500
341 0064	40		25/250
341 0065	50		25/200
341 0066	63		10/150

**3474**

Inel de compresie O-ring

Cod	Dimensiune	Pret €	Ambalare
340 0125	20		50/1200
340 0108	25		50/800
340 0110	32		25/500
340 0123	40		25/250
340 0122	50		25/200
340 0126	63		10/150

**3475**
O-ring

Cod	Dimensiune	Pret €	Ambalare
340 0118	20		50/1200
340 0116	25		50/800
340 0114	32		25/500
340 0120	40		25/250
340 0119	50		25/200
340 0121	63		10/150



3460CR

**3460CR**

Racord drept M conic ISO 7/EN 10226



Cod	Dimensiune	Pret €	Ambalare
340 0006	20 x 1/2"		5/100
340 0095	25 x 1/2"		5/75
340 0002	25 x 3/4"		5/75
340 0182	25 x 1"		5/75
340 0065	32 x 3/4"		5/25
340 0001	32 x 1"		5/40
340 0028	40 x 1"		2/20
340 0004	40 x 1"1/4		2/20
340 0186	40 x 1"1/2		2/20
340 0009	50 x 1"1/2		2/10
340 0007	63 x 2"		1/10

**3462CR**

Racord drept F ISO 7/EN 10226



Cod	Dimensiune	Pret €	Ambalare
340 0016	20 x 1/2"		5/100
340 0094	25 x 1/2"		5/50
340 0010	25 x 3/4"		5/50
340 0183	25 x 1"		5/50
340 0089	32 x 3/4"		5/25
340 0005	32 x 1"		5/40
340 0188	32 x 1"1/4		5/40
340 0013	40 x 1"1/4		2/20
340 0187	40 x 1"1/2		2/20
340 0034	50 x 1"1/2		2/10
340 0189	50 x 2"		2/10
340 0026	63 x 2"		1/10

**3461CR**

Racord drept dublu



Cod	Dimensiune	Pret €	Ambalare
340 0019	20 x 20		5/50
340 0011	25 x 25		5/40
340 0008	32 x 32		5/25
340 0029	40 x 40		2/10
340 0025	50 x 50		2/8
340 0015	63 x 63		1/8

**3471CR**

Prelungitor pentru reparatii



Cod	Dimensiune	Pret €	Ambalare
340 0071	32 x 32		5/20
340 0082	40 x 40		2/10
340 0073	50 x 50		2/8
340 0077	63 x 63		1/6

**3464CR**

Cot M conic ISO 7/EN 10226



Cod	Dimensiune	Pret €	Ambalare
340 0047	20 x 1/2"		5/75
340 0032	25 x 3/4"		5/50
340 0018	32 x 1"		5/25
340 0044	40 x 1"1/4		2/10
340 0053	50 x 1"1/2		2/8
340 0062	63 x 2"		1/4

3460CR

**3470CR**

Cot M 45° conic ISO 7/EN 10226



Cod	Dimensiune	Pret €	Ambalare
340 0102	25 x 3/4"		5/50
340 0099	32 x 1"		5/25
340 0115	40 x 1"1/4		2/10
340 0104	50 x 1"1/2		2/10
340 0103	63 x 2"		1/4

**3465CR**

Cot F ISO 7/EN 10226



Cod	Dimensiune	Pret €	Ambalare
340 0031	20 x 1/2"		5/50
340 0014	25 x 3/4"		5/50
340 0162	32 x 1"		5/25
340 0035	40 x 1"1/4		2/10
340 0051	50 x 1"1/2		2/8
340 0048	63 x 2"		1/5

**3466CR**

Cot F cu flansa ISO 7/EN 10226



Cod	Dimensiune	Pret €	Ambalare
340 0041	20 x 1/2"		5/50
340 0046	25 x 3/4"		5/25
340 0056	32 x 1"		5/20

**3463CR**

Cot dublu



Cod	Dimensiune	Pret €	Ambalare
340 0037	20 x 20		5/50
340 0012	25 x 25		5/25
340 0003	32 x 32		5/20
340 0017	40 x 40		2/10
340 0020	50 x 50		2/6
340 0024	63 x 63		1/4

**3468CR**

Teu M conic ISO 7/EN 10226



Cod	Dimensiune	Pret €	Ambalare
340 0088	20 x 1/2" x 20		5/50
340 0069	25 x 3/4" x 25		5/25
340 0068	32 x 1" x 32		5/15
340 0075	40 x 1"1/4 x 40		2/10
340 0086	50 x 1"1/2 x 50		2/8
340 0090	63 x 2" x 63		1/5

**3469CR**

Teu F ISO 7/EN 10226



Cod	Dimensiune	Pret €	Ambalare
340 0043	20 x 1/2" x 20		5/25
340 0030	25 x 3/4" x 25		5/25
340 0023	32 x 1" x 32		5/15
340 0045	40 x 1"1/4 x 40		2/8
340 0049	50 x 1"1/2 x 50		2/6
340 0058	63 x 2" x 63		1/3



3460CR

**3467CR**

Teu



Cod	Dimensiune	Pret €	Ambalare
340 0033	20 x 20 x 20		5/25
340 0021	25 x 25 x 25		5/20
340 0022	32 x 32 x 32		5/10
340 0050	40 x 40 x 40		2/6
340 0055	50 x 50 x 50		2/4
340 0060	63 x 63 x 63		1/2

**3472**

Piulita

Cod	Dimensiune	Pret €	Ambalare
340 0113	20		25/400
340 0112	25		25/300
340 0109	32		25/250
340 0097	40		10/200
340 0132	50		10/100
340 0124	63		5/50

**3473**

Inel de etansare

Cod	Dimensiune	Pret €	Ambalare
340 0111	20		50/1200
340 0100	25		50/800
340 0105	32		25/500
340 0106	40		25/250
340 0107	50		25/200
340 0117	63		10/150

**3474**

Inel de compresie O-ring

Cod	Dimensiune	Pret €	Ambalare
340 0125	20		50/1200
340 0108	25		50/800
340 0110	32		25/500
340 0123	40		25/250
340 0122	50		25/200
340 0126	63		10/150

**3475**

O-ring

Cod	Dimensiune	Pret €	Ambalare
340 0118	20		50/1200
340 0116	25		50/800
340 0114	32		25/500
340 0120	40		25/250
340 0119	50		25/200
340 0121	63		10/150



1460
Racord drept M ISO 228

Cod	Dimensiune	Pret €	Ambalare
340 0079	75 x 2"		1/10
340 0036	75 x 2"1/2		1/10
340 0078	90 x 2"1/2		1/6
340 0038	90 x 3"		1/6
340 0057	110 x 4"		1/3



1462
Racord drept F ISO 228

Cod	Dimensiune	Pret €	Ambalare
340 0054	75 x 2"1/2		1/10
340 0061	90 x 3"		1/6
340 0070	110 x 4"		1/3



1461
Racord drept dublu

Cod	Dimensiune	Pret €	Ambalare
340 0039	75 x 75		1/6
340 0042	90 x 90		1/6
340 0066	110 x 110		1/3



1464
Cot M ISO 228

Cod	Dimensiune	Pret €	Ambalare
340 0076	75 x 2"1/2		1/5
340 0128	90 x 3"		1/4



1465
Cot F ISO 228

Cod	Dimensiune	Pret €	Ambalare
340 0074	75 x 2"1/2		1/5
340 0129	90 x 3"		1/3



1463
Cot dublu

Cod	Dimensiune	Pret €	Ambalare
340 0059	75 x 75		1/4
340 0127	90 x 90		1/3



1468
Teu M ISO 228 F ISO 228

Cod	Dimensiune	Pret €	Ambalare
340 0130	75 x 2" M - 1"1/2 F		1/3
340 0131	90 x 2"1/2 M - 2" F		1/2



1469
Teu F ISO 228 M ISO 228

Cod	Dimensiune	Pret €	Ambalare
340 0085	75 x 2" F - 2"1/2 M		1/3
340 0084	90 x 2"1/2 F - 3" M		1/2

**1467**

Teu

Cod	Dimensiune	Pret €	Ambalare
340 0083	75 x 75 x 75		1/2
340 0081	90 x 90 x 90		1/1

**1475**

Stut de ranforsare

i "Dimensiune" se refera la dimensiunile tubului

Cod	Dimensiune	Pret €	Ambalare
340 0072	20 x 2,8		10/600
340 0040	25 x 3,0		10/350
340 0027	32 x 3,0		10/150
340 0052	40 x 3,7		5/50
340 0064	50 x 4,6		5/40
340 0063	63 x 5,8		1/20
340 0096	75 x 6,8		1/25
340 0098	90 x 8,2		1/20
340 0101	110 x 10		1/10

**1476**

Stut cu garnituri pentru tub multistrat

i "Dimensiune" se refera la dimensiunile tubului

i Accesoriu obligatoriu pentru utilizarea racordurilor Cobraring cu teava multistrat.

+ CU FUNCȚIE DIELECTRICĂ

Cod	Dimensiune	Pret €	Ambalare
340 0067	40 x 3,5		10/60
340 0080	50 x 4,0		5/30
340 0087	63 x 4,5		1/25
340 0178	75 x 5,0		1/20
340 0179	90 x 7,0		1/20

INSTRUCIUNI DE MONTAJ

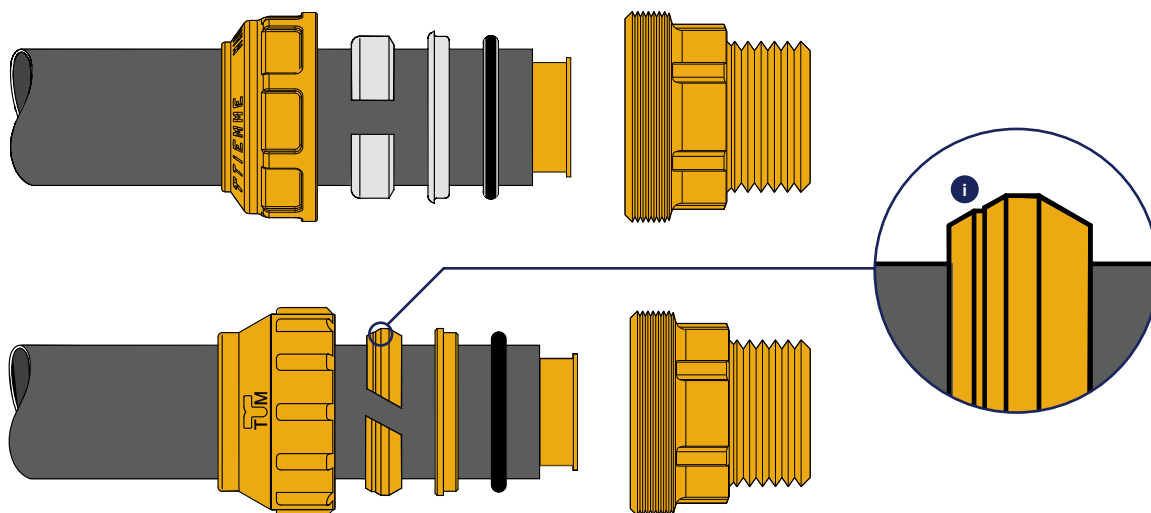

TAIEREA TUBULUI

Este recomandabila taierea tubului cu sculele recomandate care asigura o linie neteda si cat mai perpendiculara posibil pe axul tubului.

DEBAVURAREA SI CURATIREA TUBULUI

Debavurati tubul interior si mai ales exterior pentru a elimina eventualele resturi si aschii.

INTRODUCEREA STUTULUI DE RANFORSARE ÎN TUB

Așezați stutul de ranforsare (art. 1475 sau art. 1476) la capătul tubului, până la capăt. Această operațiune este obligatorie în sistemul de aplicație și în combinație cu tipologia țevilor prezentate mai jos:

Domeniu de aplicare	Tipologie tub	Fitinguri „COBRA RING” potrivite pentru utilizare	Stut de ranforsare obligatoriu
Apa calda	PE/ PE-HD/ PEX	Toate seriile	Art. 1475
Gaz metan sau GPL	PE-HD	seria 3460CR	Art. 1475
Apa rece sau calda	Multistrat AL-COBRAPEX	Toate seriile	Art. 1476

MONTAJUL RACORDULUI

Introduceți piulița și inelul sectionat pe tub (mica incizie exterioră a inelului trebuie să fie neapărat în fața piuliței) și introduceți capătul țevii în fitting, având grijă să nu deplasați garnitura din locașul acesteia. Înșurubați piulița cu mâna strângând-o pe cât posibil și apoi, cu o cheie, aplicați numărul de strângeri conform indicațiilor din tabel, ținând cont că minimumul se referă la tubul ce are stutul de ranforsare introdus.

TABEL DE STRANGERE PIULITA - Nr. rotatii

Tub	20	25	32	40	50	63
Nr. rotatii	min. 1 - max 1,5	min. 1 - max 1,5	min. 1 - max 1,5	min. 1,5 - max 2	min. 1,5 - max 2	min. 1,5 - max 2

10 RACORDURI GENERALE DIN ALAMA

Seria 1500

Racorduri generale din alama "COMPACT"



172

Racorduri generale din alama



173

Racorduri generale din alama - Filetare conică ISO7 / EN 10226-1



189

Racorduri generale din alama "STEEL BLOCK"



190





1550CT
Mufa dreapta F/F

Cod	Dimensiune	Pret €	Ambalare
150 0807	1/2" x 1/2"		10/100
150 0808	3/4" x 3/4"		10/100
150 0809	1" x 1"		5/50



1561CT
Cot M/F

Cod	Dimensiune	Pret €	Ambalare
150 0813	1/2" x 1/2"		10/100
150 0814	3/4" x 3/4"		5/50
150 0815	1" x 1"		5/25



1560CT
Cot F/F

Cod	Dimensiune	Pret €	Ambalare
150 0810	1/2" x 1/2"		10/100
150 0811	3/4" x 3/4"		5/75
150 0812	1" x 1"		5/50



1570CT
Teu F

Cod	Dimensiune	Pret €	Ambalare
150 0816	1/2" x 1/2" x 1/2"		10/100
150 0817	3/4" x 3/4" x 3/4"		5/50
150 0818	1" x 1" x 1"		5/25





1552
Niplu / Niplu redus

Cod	Dimensiune	Pret €	Ambalare
150 0354	1/4" x 1/4"		10/200
150 0306	3/8" x 1/4"		10/200
150 0218	3/8" x 3/8"		10/200
150 0395	1/2" x 1/4"		10/150
150 0074	1/2" x 3/8"		10/200
150 0002	1/2" x 1/2"		10/150
150 0012	3/4" x 1/2"		10/100
150 0008	3/4" x 3/4"		10/100
150 0089	1" x 1/2"		5/100
150 0022	1" x 3/4"		5/100
150 0001	1" x 1"		5/100
150 0044	1"1/4 x 1"		5/50
150 0025	1"1/4 x 1"1/4		5/50
150 1052	1"1/2 x 1"		5/50
150 0097	1"1/2 x 1"1/4		5/50
150 0088	1"1/2 x 1"1/2		5/25
150 0164	2" x 1"1/2		2/30
150 0081	2" x 2"		2/20
150 0486	2"1/2 x 1"1/2		2/20
150 0279	2"1/2 x 2"1/2		2/10
150 0375	3" x 3"		1/5
150 0487	4" x 4"		1/5



1552C
Niplu / Niplu redus
Versiunea cromata

Cod	Dimensiune	Pret €	Ambalare
150 0624	3/8" x 1/4"		10/400
150 0502	3/8" x 3/8"		10/400
150 0406	1/2" x 3/8"		10/350
150 0234	1/2" x 1/2"		10/300
150 0447	3/4" x 1/2"		10/200
150 0435	3/4" x 3/4"		10/200
150 0613	1" x 1/2"		5/130
150 0555	1" x 3/4"		5/130
150 0500	1" x 1"		5/100



1552XL
Niplu XL

Cod	Dimensiune	Pret €	Ambalare
150 0803	1/2" x 1/2"		10/100
150 0841	3/4" x 3/4"		10/100
150 0842	1" x 1"		5/100



1552FD
Niplu fata dreapta (plana)

+ GARNITURA PLATA

Cod	Dimensiune	Pret €	Ambalare
471 0052	3/8" x 3/8"		25/200
471 0030	1/2" x 1/2"		10/100
471 0003	3/4" x 3/4"		10/100
471 0017	1" x 1"		5/100
471 0085	1"1/4 x 1"1/4		5/50
471 0086	1"1/2 x 1"1/2		2/30
471 0019	3/4" x 1/2"		10/100
471 0005	1" x 3/4"		5/100
471 0035	1" 1/4 x 1"		5/50
471 0039	1"1/2 x 1"1/4		5/50
471 0056	2" x 1"1/2		2/30



1552FDR
Niplu fata dreapta (plana) cu
O-RING

+ GARNITURA PLATA

Cod	Dimensiune	Pret €	Ambalare
471 0004	3/4" x 3/4" OR		10/100
471 0046	1" x 3/4" OR		5/100



1540
Bara M/M filetata

Cod	Dimensiune	Pret €	Ambalare
150 0198	1/2" x 50		1/50
150 0235	1/2" x 60		1/45
150 0312	1/2" x 70		1/40
150 0232	1/2" x 80		1/35
150 0311	1/2" x 90		1/30
150 0115	1/2" x 100		1/30
150 0155	1/2" x 150		1/15
150 0167	1/2" x 200		1/15
150 0274	1/2" x 250		1/15
150 0686	3/4" x 40		1/40
150 0221	3/4" x 50		1/30
150 0246	3/4" x 60		1/30
150 0346	3/4" x 70		1/30
150 0212	3/4" x 80		1/20
150 0419	3/4" x 90		1/20
150 0112	3/4" x 100		1/16
150 0687	3/4" x 110		1/15
150 0152	3/4" x 150		1/10
150 0187	3/4" x 200		1/15
150 0300	3/4" x 250		1/8
150 0689	1" x 4		1/25
150 0278	1" x 50		1/20
150 0255	1" x 60		1/20
150 0325	1" x 70		1/15
150 0302	1" x 80		1/15
150 0373	1" x 90		1/12
150 0126	1" x 100		1/12
150 0480	1" x 125		1/6
150 0560	1" x 130		1/6
150 0123	1" x 150		1/6
150 0159	1" x 200		1/10
150 0276	1" x 250		1/6
150 0626	1"1/4 x 50		1/20
150 0612	1"1/4 x 60		1/15
150 0631	1"1/4 x 70		1/15
150 0603	1"1/4 x 80		1/12
150 0632	1"1/4 x 90		1/12
150 0563	1"1/4 x 100		1/12
150 0629	1"1/4 x 125		1/6
150 0633	1"1/4 x 130		1/6
150 0584	1"1/4 x 150		1/6
150 0294	1"1/4 x 170		1/6
150 0516	1"1/4 x 200		1/6
150 0614	1"1/4 x 250		1/6

1540 - Bara M/M filetata

Cod	Dimensiune	Pret €	Ambalare
150 1046	1"1/2 x 100		1/10
150 1047	1"1/2 x 150		1/6
150 1048	1"1/2 x 200		1/5
150 1049	2" x 100		1/14
150 1050	2" x 150		1/10
150 1051	2" x 200		1/9

La cerere



1540C
Bara M/M filetata cromat

Cod	Dimensiune	Pret €	Ambalare
150 0877	1/2" x 50		5/120
150 0878	1/2" x 60		5/120
150 0682	1/2" x 70		1/40
150 1025	1/2" x 100		1/30
150 1028	1/2" x 150		1/15
150 1023	3/4" x 50		1/30
150 1024	3/4" x 100		1/20
150 1027	3/4" x 150		1/10



1541
Bara filetata reglabila

Cu fir alungit

Cod	Dimensiune	Pret €	Ambalare
150 0286	1/2" x 100		1/30
150 0260	1/2" x 150		1/15
150 0343	1/2" x 200		1/15
150 0271	3/4" x 100		1/20
150 0257	3/4" x 150		1/10
150 0338	3/4" x 200		1/10
150 0254	1" x 100		1/12
150 0307	1" x 150		1/6
150 0350	1" x 200		1/10
150 0378	1" x 250		1/6

Disponibila la cerere versiunea nichelata



LISTA DE PRETURI



1531C
Prelungitor cromat M/M

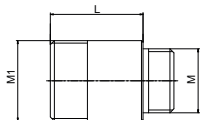

Cod	L x M → M1	Pret €	Ambalare
150 0913	16,5 x 3/8" 1/2"		5/450
150 0872	30 x 1/2" 3/4"		2/200



1550
Mufa dreapta F/F



Cod	Dimensiune	Pret €	Ambalare
150 0692	1/4" x 1/4"		10/200
150 0319	3/8" x 3/8"		10/150
150 0288	1/2" x 3/8"		10/100
150 0034	1/2" x 1/2"		10/100
150 0046	3/4" x 1/2"		10/100
150 0047	3/4" x 3/4"		10/100
150 0694	1" x 3/8"		10/100
150 0080	1" x 1/2"		10/100
150 0059	1" x 3/4"		10/100
150 0032	1" x 1"		5/50
150 0110	1"1/4 x 1"		5/50
150 0122	1"1/4 x 1"1/4		5/50
150 0131	1"1/2 x 1"1/2		2/40
150 1367	2" x 1"		2/20
150 0135	2" x 2"		2/20
150 0386	2"1/2 x 2"1/2		1/10
150 0511	4" x 4"		1/5

Până la terminarea stocului



1550C
Mufa dreapta F/F
Versiunea cromata



Cod	Dimensiune	Pret €	Ambalare
150 0573	3/8" x 3/8"		10/400
150 0869	1/2" x 3/8"		10/100
150 0434	1/2" x 1/2"		10/250
150 0870	3/4" x 1/2"		10/100
150 0542	3/4" x 3/4"		10/150
150 0439	1" x 1/2"		10/150
150 0871	1" x 3/4"		10/100
150 0594	1" x 1"		5/70



1551
Prelungire redusa M/F

A

B

Cod	Dimensiune A x B	Pret €	Ambalare
150 0861	1/4" x 3/8"		10/100
150 0862	1/4" x 1/2"		10/100
150 0529	3/8" x 3/8"		10/100
150 0106	3/8" x 1/2"		10/100
150 0581	3/8" x 1"		10/100
150 0305	1/2" x 3/8"		10/100
150 0259	1/2" x 1/2"		10/100
150 0043	1/2" x 3/4"		10/100
150 0158	1/2" x 1"		10/100
150 1044	1/2" x 24(19 Fil)		10/100
150 0628	24(19 Fil) x 1/2"		10/100
150 0636	24(19 Fil) x 24(19 Fil)		10/100
150 0140	3/4" x 1/2"		10/100
150 0185	3/4" x 3/4"		10/100
150 0053	3/4" x 1"		10/100
150 0165	1" x 3/4"		10/100
150 0272	1" x 1"		10/100
150 0863	1" x 1"1/4		5/50
150 0864	1"1/4 x 1"1/2		2/30

La cerere



1551C
Prelungire redusa M/F
Versiunea cromata

Cod	Dimensiune A x B	Pret €	Ambalare
150 0459	3/8" x 1/2"		10/300
150 0571	1/2" x 3/8"		10/300
150 0484	1/2" x 3/4"		10/200
150 0582	1/2" x 1"		10/150
150 1045	1/2" x 24(19 Fil)		10/250
150 0634	24(19 Fil) x 1/2"		10/250
150 0635	24(19 Fil) x 24(19 Fil)		10/200
150 0505	3/4" x 1/2"		10/250
150 0474	3/4" x 1"		10/130
150 0566	1" x 3/4"		10/120



1551FD
Racord drept M/F fata dreapta
(plana)

GARNITURA PLATA

Cod	Dimensiune A x B	Pret €	Ambalare
471 0078	3/4" x 1"		10/100



1220
Prelungitor M/F

i Disponibila la cerere versiunea cromata

Cod	Dimensiune	Pret €	Ambalare
150 0156	1/2" x 10 mm		25/400
150 0183	1/2" x 15 mm		25/350
150 0204	1/2" x 20 mm		10/300
150 0361	1/2" x 25 mm		10/250
150 0292	1/2" x 30 mm		10/200



1530
Prelungitor M/F

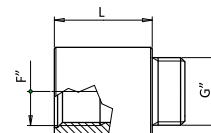

Cod	L x G → F	Pret €	Ambalare
150 0413	10 x 3/8" 3/8"		10/500
150 0482	15 x 3/8" 3/8"		10/450
150 0422	20 x 3/8" 3/8"		10/300
150 0471	30 x 3/8" 3/8"		10/250
150 0528	40 x 3/8" 3/8"		10/200
150 0497	50 x 3/8" 3/8"		10/200
150 0026	10 x 1/2" 1/2"		10/350
150 0031	15 x 1/2" 1/2"		10/300
150 0024	20 x 1/2" 1/2"		10/250
150 0100	25 x 1/2" 1/2"		10/200
150 0038	30 x 1/2" 1/2"		10/150
150 0079	40 x 1/2" 1/2"		5/120
150 0045	50 x 1/2" 1/2"		5/100
150 0145	80 x 1/2" 1/2"		5/80
150 0104	100 x 1/2" 1/2"		5/70
150 0333	150 x 1/2" 1/2"		5/50
150 0217	10 x 3/4" 3/4"		10/200
150 0211	15 x 3/4" 3/4"		10/200
150 0142	20 x 3/4" 3/4"		10/180
150 0301	25 x 3/4" 3/4"		5/150
150 0143	30 x 3/4" 3/4"		5/100
150 0236	40 x 3/4" 3/4"		5/100
150 0161	50 x 3/4" 3/4"		5/80
150 0321	80 x 3/4" 3/4"		5/50
150 0284	100 x 3/4" 3/4"		5/40
150 0390	10 x 1" 1"		10/150
150 0404	15 x 1" 1"		10/130
150 0268	20 x 1" 1"		10/120
150 0314	25 x 1" 1"		5/90
150 0256	30 x 1" 1"		5/80
150 0369	40 x 1" 1"		5/70
150 0245	50 x 1" 1"		5/60



**1530C**

Prelungitor cromat M/F

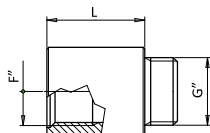

Cod	L x G → F	Pret €	Ambalare
150 0449	10 x 3/8" 3/8"		10/500
150 0458	15 x 3/8" 3/8"		10/450
150 0437	20 x 3/8" 3/8"		10/300
150 0442	30 x 3/8" 3/8"		10/250
150 0534	40 x 3/8" 3/8"		10/200
150 0519	50 x 3/8" 3/8"		10/200
150 0055	10 x 1/2" 1/2"		10/350
150 0069	15 x 1/2" 1/2"		10/300
150 0060	20 x 1/2" 1/2"		10/250
150 0170	25 x 1/2" 1/2"		10/200
150 0071	30 x 1/2" 1/2"		10/200
150 0113	40 x 1/2" 1/2"		5/120
150 0052	50 x 1/2" 1/2"		5/100
150 1037	60 x 1/2" 1/2"		5/100
150 1038	70 x 1/2" 1/2"		5/90
150 0184	80 x 1/2" 1/2"		5/80
150 1039	90 x 1/2" 1/2"		5/75
150 0188	100 x 1/2" 1/2"		5/70
150 0402	150 x 1/2" 1/2"		5/50
150 0335	10 x 3/4" 3/4"		10/200
150 0317	15 x 3/4" 3/4"		10/200
150 0269	20 x 3/4" 3/4"		10/180
150 0348	25 x 3/4" 3/4"		5/150
150 0240	30 x 3/4" 3/4"		5/100
150 0252	40 x 3/4" 3/4"		5/100
150 0139	50 x 3/4" 3/4"		5/80
150 1040	60 x 3/4" 3/4"		5/80
150 1041	70 x 3/4" 3/4"		5/70
150 0313	80 x 3/4" 3/4"		5/50
150 1042	90 x 3/4" 3/4"		5/50
150 0309	100 x 3/4" 3/4"		5/40
150 0504	10 x 1" 1"		10/150
150 0521	15 x 1" 1"		10/130
150 0425	20 x 1" 1"		10/120
150 0491	25 x 1" 1"		5/90
150 0405	30 x 1" 1"		5/80
150 0393	40 x 1" 1"		5/70
150 0328	50 x 1" 1"		5/60

**1581**

Reductie M/F

Cod	Dimensiune A x B	Pret €	Ambalare
150 0455	1/4" x 1/8"		25/200
150 0380	3/8" x 1/8"		25/200
150 0308	3/8" x 1/4"		25/200
150 0506	1/2" x 1/8"		25/100
150 0134	1/2" x 1/4"		25/200
150 0093	1/2" x 3/8"		25/200
150 0209	3/4" x 3/8"		10/100
150 0013	3/4" x 1/2"		10/100
150 0367	1" x 1/4"		10/100
150 0330	1" x 3/8"		10/100
150 0030	1" x 1/2"		10/100
150 0016	1" x 3/4"		10/100
150 0462	1"1/4 x 1/2"		5/50
150 0098	1"1/4 x 3/4"		5/50
150 0028	1"1/4 x 1"		5/50
150 1010	1"1/2 x 1/2"		5/50
150 0190	1"1/2 x 3/4"		5/50
150 0075	1"1/2 x 1"		5/50
150 0082	1"1/2 x 1"1/4		5/50
150 1377	2" x 1/2"		2/40
150 1378	2" x 3/4"		2/40
150 0731	2" x 1"		2/40
150 0138	2" x 1"1/4		2/40
150 0130	2" x 1"1/2		2/40
150 0495	2"1/2 x 1"		2/30
150 0499	2"1/2 x 1"1/4		2/20
150 0421	2"1/2 x 1"1/2		2/20
150 0219	2"1/2 x 2"		2/30
150 0526	3" x 1"1/2		1/15
150 0324	3" x 2"		1/15
150 0398	3" x 2"1/2		1/18
150 0451	4" x 2"		1/10
150 0514	4" x 2"1/2		1/10
150 0518	4" x 3"		1/9



1581C
Reductie M/F Versiunea cromata

Cod	Dimensiune A x B	Pret €	Ambalare
150 0579	1/4" x 1/8"		25/1300
150 0588	3/8" x 1/8"		25/1000
150 0546	3/8" x 1/4"		25/1000
150 0585	1/2" x 1/8"		25/500
150 0553	1/2" x 1/4"		25/500
150 0262	1/2" x 3/8"		10/500
150 0400	3/4" x 1/2"		10/250
150 0558	1" x 1/2"		10/180
150 0539	1" x 3/4"		10/180
150 0564	1"1/4 x 1"		5/50
150 0611	1"1/2 x 1"1/4		5/70

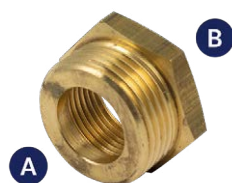

1581FD
Reductie M/F fata dreapta

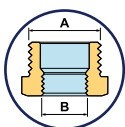

GARNITURA PLATA

Cod	Dimensiune A x B	Pret €	Ambalare
471 0050	1/2" x 3/8"		25/100
471 0022	3/4" x 1/2"		10/100
471 0079	1" x 1/2"		10/100
471 0012	1" x 3/4"		10/100
471 0038	1" 1/4 x 1"		5/50
471 0111	1" 1/2 x 1"		5/50
471 0043	1"1/2 x 1" 1/4		5/50
471 0072	2" x 1"1/2		2/40



1582
Reductie inelara

Cod	Dimensiune	Pret €	Ambalare
150 0445	1/2" x 3/8"		25/300
150 0356	3/4" x 1/2"		25/200
150 0357	1" x 3/4"		10/100



1562
Cot M/M

Cod	Dimensiune	Pret €	Ambalare
150 0384	3/8" x 3/8"		10/100
150 0107	1/2" x 1/2"		10/100
150 0214	3/4" x 3/4"		10/100

ISO 228 cu fata dreapta



1560
Cot F/F

Cod	Dimensiune	Pret €	Ambalare
150 0298	3/8" x 3/8"		10/100
150 0508	1/2" x 3/8"		10/100
150 0018	1/2" x 1/2"		10/100
150 0149	3/4" x 1/2"		5/100
150 0015	3/4" x 3/4"		5/75
150 0111	1" x 3/4"		5/50
150 0017	1" x 1"		5/50
150 0340	1"1/4 x 1"		5/25
150 0067	1"1/4 x 1"1/4		5/25
150 0117	1"1/2 x 1"1/2		5/20
150 0121	2" x 2"		2/10
150 0515	4" x 4"		1/3





1560C

Cot F/F

Versiunea cromata

Cod	Dimensiune	Pret €	Ambalare
150 0537	3/8" x 3/8"		10/200
150 0349	1/2" x 1/2"		10/180
150 0513	3/4" x 3/4"		5/80
150 0541	1" x 1"		5/50
150 0586	1"1/4 x 1"1/4		5/35



1567

Cot F/F cu flansa 2 gauri

Cod	Dimensiune	Pret €	Ambalare
150 0287	1/2" x 1/2"		10/100
150 0360	3/4" x 3/4"		5/50



1561

Cot M/F

Cod	Dimensiune	Pret €	Ambalare
	A x B		
150 0173	3/8" x 3/8"		10/100
150 0004	1/2" x 1/2"		10/100
150 0907	1/2" x 3/4"		5/50
150 0006	3/4" x 3/4"		5/50
150 0011	1" x 1"		5/25
150 0054	1"1/4 x 1"1/4		5/25
150 0119	1"1/2 x 1"1/2		5/25
150 0086	2" x 2"		2/10

1561

TABEL CU DIMENSIUNI

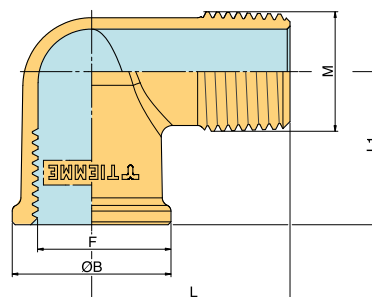

Cod	M	F	L	L1	ØB
150 0173	3/8"	3/8"	32	28,5	23
150 0004	1/2"	1/2"	35	27	28
150 0907	1/2"	3/4"	38	33,5	34
150 0006	3/4"	3/4"	39	31	34
150 0011	1"	1"	48	38	41,5
150 0054	1" 1/4	1" 1/4	44,5	42,5	51
150 0119	1" 1/2	1" 1/2	48,5	47,5	58
150 0086	2"	2"	59	55	70



1561C

Cot M/F. Versiunea cromata

Cod	Dimensiune	Pret €	Ambalare
150 0420	3/8" x 3/8"		10/200
150 0201	1/2" x 1/2"		10/150
150 0472	3/4" x 3/4"		5/60
150 0551	1" x 1"		5/40



1561DIN
Cot M/F seria masiva

Cod	Dimensiune	Pret €	Ambalare
150 0762	1/2" x 1/2"		10/100
150 0763	3/4" x 3/4"		5/50
150 0764	1" x 1"		5/25

Până la terminarea stocului

1561DIN TABEL CU DIMENSIUNI

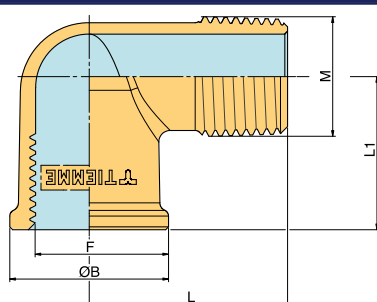

Cod	M	F	L	L1	Ø B
150 0762	1/2"	1/2"	36	29	29
150 0763	3/4"	3/4"	42	33	35
150 0764	1"	1"	54	41	43



1563
Cot M/F cu flansa

Cod	Dimensiune	Pret €	Ambalare
150 0048	1/2" x 1/2"		10/100
150 0064	3/4" x 3/4"		5/50
150 0033	1" x 1"		5/25



1584C
Cot M/M fata dreapta cu flansa (cromată lucioasă)

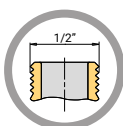

i Furnizat cu suruburi si diblu

Cod	Dimensiune	Pret €	Ambalare
150 0800	3/4" x 1/2"		1/100



1585C
Cot F/M fata dreapta cu flansa (cromată lucioasă)

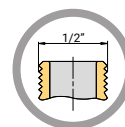

i Furnizat cu suruburi si diblu

Cod	Dimensiune	Pret €	Ambalare
150 0804	1/2" x 1/2"		1/100



1572
Teu M

Cod	Dimensiune	Pret €	Ambalare
150 0561	3/8" x 3/8" x 3/8"		10/100
471 0020	1/2" x 1/2" x 1/2"		10/100
150 0225	3/4" x 3/4" x 3/4"		5/75
150 0216	1" x 1" x 1"		5/50



1572FD
Teu masculin fata dreapta

+ GARNITURA PLATA

Cod	Dimensiune	Pret €	Ambalare
	1 2 3		
471 0020	1/2" x 1/2" x 1/2"		10/100
471 0040	3/4" x 1/2" x 1/2"		5/75
471 0041	3/4" x 1/2" x 3/4"		5/75
471 0060	3/4" x 3/4" x 1/2"		5/75
471 0011	3/4" x 3/4" x 3/4"		5/75
471 0049	1" x 3/4" x 1"		5/50
471 0084	1" x 1" x 1"		5/50





1570
Teu F

Cod	Dimensiune			Pret €	Ambalare
	1	2	3		
150 0275	3/8"	3/8"	3/8"		10/100
150 0533	1/2"	3/8"	1/2"		10/100
150 0003	1/2"	1/2"	1/2"		10/100
150 0544	3/4"	3/8"	3/4"		5/50
150 0049	3/4"	1/2"	3/4"		5/50
150 0915	3/4"	3/4"	1/2"		5/50
150 0009	3/4"	3/4"	3/4"		5/50
150 0037	1"	1/2"	1"		5/25
150 0087	1"	3/4"	1"		5/25
150 0005	1"	1"	1"		5/25
150 0441	1"1/4"	1/2"	1"1/4"		5/25
150 0446	1"1/4"	3/4"	1"1/4"		5/25
150 0719	1"1/4"	1"	1"1/4"		5/25
150 0029	1"1/4x1"1/4x1"1/4				5/20
150 0078	1"1/2x1"1/2x1"1/2				5/15
150 0120	2"	2"	2"		2/10
150 0481	4"	4"	4"		1/2



1570C
Teu F
Versiunea cromata

Cod	Dimensiune			Pret €	Ambalare
	1	2	3		
150 0545	3/8"	3/8"	3/8"		10/150
150 0253	1/2"	1/2"	1/2"		10/110
150 0596	3/4"	1/2"	3/4"		5/50
150 0501	3/4"	3/4"	3/4"		5/50
150 0570	1"	1"	1"		5/30



1571
Teu F-M- F

Cod	Dimensiune	Pret €	Ambalare
150 0843	1/2" x 1/2" x 1/2"		10/100
150 0844	3/4" x 3/4" x 3/4"		5/50
150 0845	1" x 1" x 1"		5/25



1580
Cruce F

i Disponibila la cerere versiunea cromata

Cod	Dimensiune	Pret €	Ambalare
150 0103	1/2"		5/75
150 0065	3/4"		5/25
150 0091	1"		5/25
150 0182	1" 1/4		5/15
150 0299	1" 1/2		5/15
150 0414	2"		1/5



1555
Olandez cu O-RING M/F

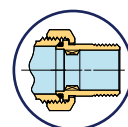

i Disponibila la cerere versiunea cromata

Cod	Dimensiune	Pret €	Ambalare
150 0014	1/2" x 1/2"		5/100
150 0010	3/4" x 3/4"		5/50
150 0007	1" x 1"		5/50
150 0039	1"1/4 x 1"1/4		5/25
150 0023	1"1/2 x 1"1/2		2/20
150 0020	2" x 2"		2/10



1555U

Olandez cu **O-RING**
Temperatura de functionare-
15 ÷ 200 °C

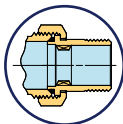

i Pentru utilizare cu apa, hidrocarburi si gaz (metan sau GPL)

Cod	Dimensiune	Pret €	Ambalare
150 0777	1/2" x 1/2"		5/100
150 0778	3/4" x 3/4"		5/50
150 0779	1" x 1"		5/50



1555R

Olandez cu **O-RING** si
preetansare pe filetul exterior
M/F

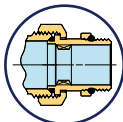

Cod	Dimensiune	Pret €	Ambalare
150 0523	3/4" x 3/4"		5/50
150 0283	1" x 1"		5/50
150 0524	1"1/4 x 1"1/4		5/25



1555CP

Olandez cu **GARNITURA PLATA**
M/F

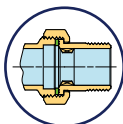

Cod	Dimensiune	Pret €	Ambalare
150 0708	3/8" x 3/8"		10/200
150 0203	1/2" x 1/2"		5/100
150 0181	3/4" x 3/4"		5/50
150 0213	1" x 1"		5/50
150 0320	1"1/4 x 1"1/4		5/25
150 0575	1"1/2 x 1"1/2		2/20
150 0556	2" x 2"		2/10



1565

Cot olandez M/F cu garnitura
O-RING

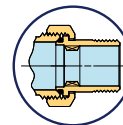

Cod	Dimensiune	Pret €	Ambalare
150 0410	3/8" x 3/8"		10/100
150 0105	1/2" x 1/2"		5/75
150 0063	3/4" x 3/4"		5/50
150 0068	1" x 1"		5/25
150 0194	1"1/4 x 1"1/4		2/20
150 0229	1"1/2 x 1"1/2		2/10
150 0281	2" x 2"		2/6



1565R

Cot olandez M/F cu garnitura
O-RING si preetansare pe filetul
exterior

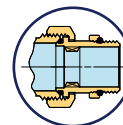

Cod	Dimensiune	Pret €	Ambalare
150 0618	3/4" x 3/4"		5/50
150 0591	1" x 1"		5/25
150 0620	1"1/4 x 1"1/4		2/20



1565CP

Cot olandez M/F cu **GARNITURA
PLATA**

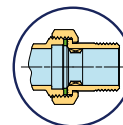

Cod	Dimensiune	Pret €	Ambalare
150 0401	1/2" x 1/2"		5/75
150 0359	3/4" x 3/4"		5/50
150 0381	1" x 1"		5/25
150 0465	1"1/4 x 1"1/4		2/20
150 0637	1"1/2 x 1"1/2		2/10
150 0638	2" x 2"		2/6



1557
Olandez alama F/F cu inchidere pe CON

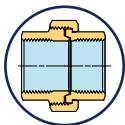

i Disponibila la cerere versiunea cromata

Cod	Dimensiune	Pret €	Ambalare
150 0186	1/2" x 1/2"		5/100
150 0199	3/4" x 3/4"		5/50
150 0177	1" x 1"		5/50
150 1054	1" 1/4 x 1" 1/4		5/25
150 1055	1" 1/2 x 1" 1/2		2/20
150 1056	2" x 2"		2/10

La cerere



1557CP
Olandez cu GARNITURA PLATA F/F

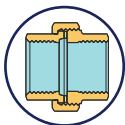

Cod	Dimensiune	Pret €	Ambalare
150 0358	1/2" x 1/2"		5/100
150 0383	3/4" x 3/4"		5/50
150 0403	1" x 1"		5/50
150 1060	1" 1/4 x 1" 1/4		5/25
150 1061	1" 1/2 x 1" 1/2		2/20
150 1062	2" x 2"		2/10

La cerere



4746
Racord in unghi drept din trei bucati cu supapa dubla de blocare si izolare pentru vasul de expansiune.

Cod	Dimensiune	Pret €	Ambalare
470 0028	3/4" M - 3/4" F		5/50

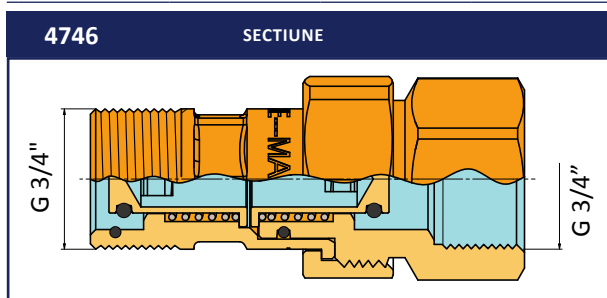

1513
Excentric cu ampatament 15 mm M/F

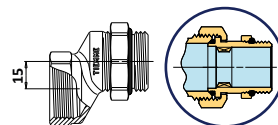

Cod	Dimensiune	Pret €	Ambalare
150 0444	1"		2/50



1514
Excentric cu ampatament 25 mm M/F

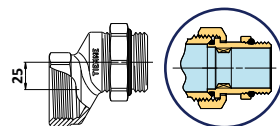

Cod	Dimensiune	Pret €	Ambalare
150 0672	1"		2/40

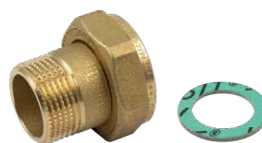

1521CP
Semiolandez cu GARNITURA PLATA

i Include: 1 stut, 1 piulita, 1 garnitura

Cod	Dimensiune	Pret €	Ambalare
150 0798	3/4" x 1/2"		5/100
150 0822	1" x 3/4"		5/100
150 0823	1" 1/4 x 1"		5/50
150 0890	1" 1/2 x 1" 1/4		5/50



1521
Semiolandez

i Include: 1 stut, 1 piulita

Cod	Dimensiune	Pret €	Ambalare
150 0795	3/4" x 1/2"		5/100
150 0796	1" x 3/4"		5/100



1522

Set niplu + piulita pentru APOMETRU

Cod	Dimensiune	Pret €	Ambalare
150 0035	3/4" x 1/2"		1/100
150 0042	1" x 3/4"		1/60
150 0062	1"1/4 x 1"		1/30
150 0094	1"1/2 x 1"1/4		1/20
150 1063	2" x 1"1/2		1/30
150 1064	2"1/2 x 2"		1/14
150 0914	2"3/8 x 2"		1/5

Setul cuprinde: 2 nipluri, 2 piulite si 2 garnituri

Setul cuprinde: 1 nipluri, 1 piulite si 1 garnituri

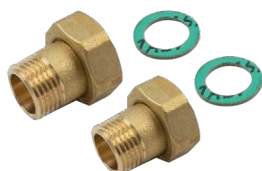

1555SET

Set olandez din alama pentru pompa cu racorduri M/F si GARNITURA PLATA.

i Kitul contine: 2 stuturi, 2 piulite, 2 garnituri

Cod	Dim.	Atac pompa	Pret €	Ambalare
150 0825	1/2"	3/4"		1/50
150 0826	3/4"	1"		1/50
150 0827	1"	1"1/4		1/25
150 0578	1"1/4	1"1/2		1/20



1557SET

Set olandez din alama pentru pompa cu racorduri F/F si GARNITURA PLATA.

i Kitul contine: 2 stuturi, 2 piulite, 2 garnituri

Cod	Dim.	Atac pompa	Pret €	Ambalare
150 0906	1/2"	1"		1/50
150 0839	3/4"	1"1/4		1/25
150 0355	1"	1"1/2		1/20
150 0440	1"1/4	2"		1/10



1525N

Racord drept M nichelat cu piulita si garnitura plata

Cod	Dimensiune	Pret €	Ambalare
150 0891	1/2" x 1/2"		5/100
150 0893	3/4" x 3/4"		5/100
150 0897	1" x 1"		5/50
150 0898	1"1/4 x 1"1/4		2/50



1524

Racord drept f-f cu olandez si garnitura plata

Cod	Dimensiune	Pret €	Ambalare
150 0858	3/4"		1/100



1564FD

Cot M cu piulita libera si garnitura plata

+ GARNITURA PLATA

Cod	Dimensiune	Pret €	Ambalare
150 0520	3/4" x 3/4"		5/50



1583

Piulita

Cod	Dimensiune	Pret €	Ambalare
150 0125	1/2"		10/150
150 0191	3/4"		10/150
150 0261	1"		10/100
150 0310	1"1/4		10/100
150 0303	1"1/2		5/100
150 0332	2"		5/100



1878
Dop M

Cod	Dimensiune	Pret €	Ambalare
150 0273	3/8"		25/200
150 0040	1/2"		25/300
150 0019	3/4"		10/150
150 0077	1"		10/100
150 0222	1"1/4		5/100
150 0865	1"1/2		5/50
150 0866	2"		2/40

Disponibila la cerere versiunea cromata



1880
Dop F

Cod	Dimensiune	Pret €	Ambalare
150 0342	3/8"		25/200
150 0058	1/2"		25/200
150 0041	3/4"		10/100
150 0108	1"		10/100
150 0285	1"1/4		5/100
150 0327	1"1/2		5/60
150 0751	2"		2/50



1880C
Dop F pentru colectoare.
Versiunea cromata

Cod	Dimensiune	Pret €	Ambalare
150 0745	3/8"		25/800
150 0747	1/2"		25/600
150 0749	3/4"		10/100
150 0868	1"		10/100



1553FD
Niplu fata dreapta de legatura cu teava de cupru

+ GARNITURA PLATA

Cod	Dimensiune	Pret €	Ambalare
471 0057	∅ 15 - 3/4"		5/100
471 0016	∅ 22 - 3/4"		5/100
471 0036	∅ 22 - 1"		5/100



1507
Racord drept masculin pentru teava cupru curbata

Cod	Dimensiune	Pret €	Ambalare
111 0003	12 x 1/2"		10/100



1508
Racord drept feminin pentru teava cupru curbata

Cod	Dimensiune	Pret €	Ambalare
111 0004	12 x 1/2"		10/100

1507 - 1508 **EXEMPLU DE INSTALARE**

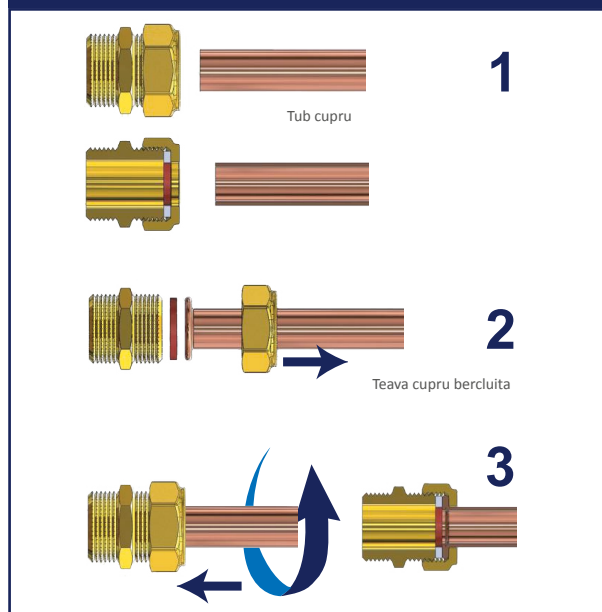



1511
Racord 3 cai pentru HIDROFOR

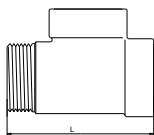

Cod	Dimensiune	Pret €	Ambalare
150 0147	L = 72 x 1"		5/50



1510
Racord 5 cai pentru HIDROFOR

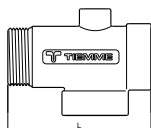

Cod	Dimensiune	Pret €	Ambalare
150 0128	L = 72 x 1"		5/40
150 0163	L = 82 x 1"		5/40
150 0132	L = 92 x 1"		5/35



1500
Portfurtun tip "Roma" cu filetul M

Cod	Dimensiune	Pret €	Ambalare
150 0473	6 x 1/4"		25/1000
150 0568	8 x 1/4"		25/1000
150 0507	10 x 1/4"		25/1000
150 0479	10 x 3/8"		25/600
150 0522	12 x 3/8"		25/600
150 0326	12 x 1/2"		10/350
150 0547	14 x 3/8"		10/400
150 0418	14 x 1/2"		10/300
150 0160	15 x 1/2"		10/300
150 0189	20 x 1/2"		10/250
150 0116	20 x 3/4"		10/200
150 0192	25 x 3/4"		10/150
150 0129	25 x 1"		10/100
150 0223	30 x 1"		10/80
150 0241	35 x 1"1/4		5/50
150 0239	40 x 1"1/2		5/40
150 0417	45 x 1"1/2		5/35
150 0215	50 x 2"		2/20

Disponibila la cerere versiunea nichelata



1501
Portfurtun tip "Roma" cu filetul F

Cod	Dimensiune	Pret €	Ambalare
150 0592	10 x 1/4"		25/600
150 0454	10 x 3/8"		25/600
150 0293	10 x 1/2"		25/500
150 0387	13 x 1/2"		10/400
150 0280	15 x 1/2"		10/300
150 0365	18 x 1/2"		10/300
150 0263	20 x 3/4"		10/200
150 0289	25 x 1"		10/100
150 0423	30 x 1"		10/80
150 0498	30 x 1"1/4		5/80
150 0496	35 x 1"1/4		5/75



1516
Racord drept prelungit pentru rezervor realizat prin matritare

Cod	Dimensiune	Pret €	Ambalare
150 0270	1/2"		5/40
150 0220	3/4"		5/25
150 0166	1"		5/15
150 0208	1"1/4		2/10
150 0295	1"1/2		1/8
150 0248	2"		1/5



1517
Racord de scurgere pentru rezervor

Cod	Dimensiune	Pret €	Ambalare
150 0469	1/2"		5/50
150 0411	3/4"		5/30
150 0371	1"		5/25
150 0443	1"1/4		2/10





1518
1519
Racord pentru rezervor cu dop
(1519 fara dop)

Cod	Dimensiune	Pret €	Ambalare
1518 - Cu dop			
150 0408	1/2"		5/50
150 0397	3/4"		5/30
150 0322	1"		5/25
150 0457	1"1/4		2/16
1519 - Fara dop			
150 0153	1/2"		5/50
150 0179	3/4"		5/30
150 0176	1"		5/25
150 0231	1"1/4		2/16



1520
Cot pentru rezervor

Cod	Dimensiune	Pret €	Ambalare
150 0460	1/2"		5/25
150 0476	3/4"		5/20
150 0463	1"		2/12



1502
Racord drept pentru pompa

Cod	Dimensiune	Pret €	Ambalare
150 0388	15 x 1/2"		5/40
150 0323	20 x 3/4"		5/30
150 0329	25 x 1"		5/30
150 0407	30 x 1"		5/20
150 0466	30 x 1"1/4		3/15
150 0452	35 x 1"1/4		3/15
150 0394	40 x 1"1/2		2/12
150 0370	50 x 2"		1/5
150 0424	60 x 2"		1/3
150 0587	60 x 2"1/2		1/3



1503
Racord cot pentru pompa

Cod	Dimensiune	Pret €	Ambalare
150 0490	15 x 1/2"		5/40
150 0494	20 x 3/4"		5/30
150 0492	25 x 1"		2/20
150 0548	30 x 1"		1/15
150 0600	30 x 1"1/4		1/10
150 0593	35 x 1"1/4		1/10
150 0554	40 x 1"1/2		1/6
150 0538	50 x 2"		1/4
150 0610	60 x 2"		1/2
150 0630	60 x 2"1/2		1/2



1504
Racord din 3 piese pentru pompa

Cod	Dimensiune	Pret €	Ambalare
150 0531	15		5/40
150 0509	18		5/40
150 0467	20		5/30
150 0438	25		5/30
150 0605	45		1/5

Până la terminarea stocului



R616NAS

Bandă din teflon

Cod	Dimensiune	Pret €	Ambalare
150 0786	12mm x 12m x 0,076mm		10/150



R616

Teflon lichid

Cod	Dimensiune	Pret €	Ambalare
056 0002	100 gr.		1/50



NOUȚĂȚI



155217
Niplu / Niplu redus

Cod	Dimensiune	Pret €	Ambalare
150 2041	1/2" x 1/2"		10/100
150 2042	3/4" x 3/4"		10/100
150 2043	1" x 1"		5/100

NOUȚĂȚI



153017
Prelungitor M/F

Cod	Dimensiune	Pret €	Ambalare
150 2044	1/2" - L = 20 mm		10/250
150 2045	1/2" - L = 30 mm		10/150
150 2046	3/4" - L = 20 mm		10/180
150 2047	3/4" - L = 20 mm		5/100
150 2049	1" - L = 30 mm		5/80



1561
Cot M/F

Cod	Dimensiune	Pret €	Ambalare
150 0004	1/2" x 1/2"		10/100
150 0006	3/4" x 3/4"		5/50
150 0011	1" x 1"		5/25

NOUȚĂȚI



155517
Olandez cu O-RING M/F

Cod	Dimensiune	Pret €	Ambalare
150 2053	1/2" x 1/2"		5/100
150 2054	3/4" x 3/4"		5/50
150 2055	1" x 1"		5/50

NOUȚĂȚI



156517
Cot olandez M/F cu garnitura O-RING

Cod	Dimensiune	Pret €	Ambalare
150 2056	1/2" x 1/2"		5/75
150 2057	3/4" x 3/4"		5/50
150 2058	1" x 1"		5/25

NOUȚĂȚI

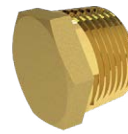

187817
Dop M

Cod	Dimensiune	Pret €	Ambalare
150 2050	1/2"		25/300
150 2051	1/2"		10/150
150 2052	3/4"		10/100



1590
Racord drept M



i Pentru țevi din oțel conforme cu standardul EN 10255

Cod	Dimensiune	Pret €	Ambalare
150 0118	3/8"		5/120
150 0021	1/2"		2/60
150 0051	3/4"		2/50
150 0056	1"		2/34
150 0092	1"1/4		1/20
150 0090	1"1/2		1/15
150 0085	2"		1/10



1592
Racord drept F



i Pentru țevi din oțel conforme cu standardul EN 10255

Cod	Dimensiune	Pret €	Ambalare
150 0114	3/8"		5/120
150 0027	1/2"		2/60
150 0050	3/4"		2/50
150 0066	1"		2/34
150 0109	1"1/4		1/20
150 0099	1"1/2		1/15
150 0102	2"		1/10



1591
Racord drept dublu



i Pentru țevi din oțel conforme cu standardul EN 10255

Cod	Dimensiune	Pret €	Ambalare
150 0389	3/8"		5/80
150 0242	1/2"		2/50
150 0237	3/4"		2/40
150 0226	1"		2/26
150 0282	1"1/4		1/15
150 0210	1"1/2		1/15
150 0195	2"		1/10

**1590 - 1591 -
1592**

DESCRIERE

Racordurile Art. 1590 - 1591 - 1592 sunt destinate reparațiilor simple, sigure și rapide a țevilor din oțel; nu mai este necesară operația de filetare a țevii și sunt de tip culisant. Aceste racorduri au în componență un inel de etansare conic. Nu este recomandată folosirea racordurilor cu substanțe acide, alcaline, acetone, eteri, hidrocarburi, lichid de frână, aburi etc.

- Temperatura de lucru: -25 +100 °C
- Presiune maximă: 20 bar

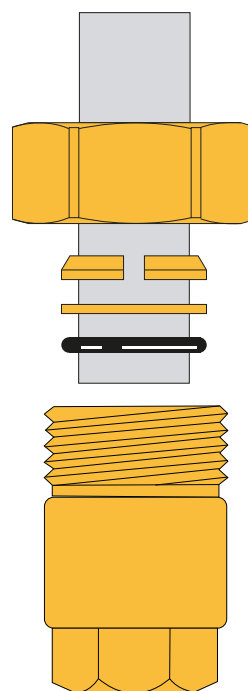

11 COLECTOARE DE DISTRIBUTIE



Colectoare de distributie "NINO" cu robineti cu sfera		192
Colectoare de distributie "MAXIMA" cu robineti de oprire		194
Colectoare de distributie "MAXIMA CORNER" cu robineti de oprire		197
Colectoare de distributie "MAXIMA VERTI" cu robineti de oprire		198
Colectoare universale premontate in casete "SANIBOX"		201
Colectoare de distributie "LINEARE"		203
Colector de distributie stantat, model "FLOOR" cu filet M/F fazat		205
Colector de distributie model "INDUSTRIAL FLOOR" cu filet M/F fazat		206
Accesorii pentru colectoare		207
Casete si seturi de prindere		216
Robineti cu sfera, motorizati		219
Adaptoare pentru colectoare		224

Utilizare cu caseta 1810, 1812, 1910P, 1920-1930 și 1939-1940 (pag. 216)



1822 1832

Colector "NINO" din alama CW617N cu robineti cu sfera. Interaxa 36 mm si iesiri 1/2"x16

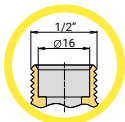

Cod	Diametru	Cai	Dimens.	Pret €	Ambalare
182 0002	3/4"G	2	1/2"(ø16)		4/32
182 0001	3/4"G	3	1/2"(ø16)		4/16
182 0016	3/4"G	4	1/2"(ø16)		4/16
182 0006	1"G	2	1/2"(ø16)		4/32
182 0005	1"G	3	1/2"(ø16)		4/16
Versiunea nichelata					
182 0004	3/4"G	2	1/2"(ø16)		4/32
182 0003	3/4"G	3	1/2"(ø16)		4/16
182 0049	3/4"G	4	1/2"(ø16)		4/16
182 0010	1"G	2	1/2"(ø16)		4/32
182 0007	1"G	3	1/2"(ø16)		4/16



1822RCP 1832RCP

Colector "NINO" din alama CW617N cu robineti cu sfera. Interaxa 36 mm si iesiri 1/2" garnitura plata. Filet fazat cu O-ring

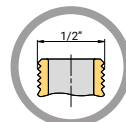

CU FILET M/F FAZATE

Cod	Diametru	Cai	Dimens.	Pret €	Ambalare
maneta tip fluture albastra					
182 0072	3/4"G	2	1/2"		4/32
182 0073	3/4"G	3	1/2"		4/16
182 0074	3/4"G	4	1/2"		4/16
182 0078	1"G	2	1/2"		4/32
182 0079	1"G	3	1/2"		4/16
maneta tip fluture rosie					
182 0075	3/4"G	2	1/2"		4/32
182 0076	3/4"G	3	1/2"		4/16
182 0077	3/4"G	4	1/2"		4/16
182 0080	1"G	2	1/2"		4/32
182 0081	1"G	3	1/2"		4/16

1822-1832 GHID DE CONEXIUNI

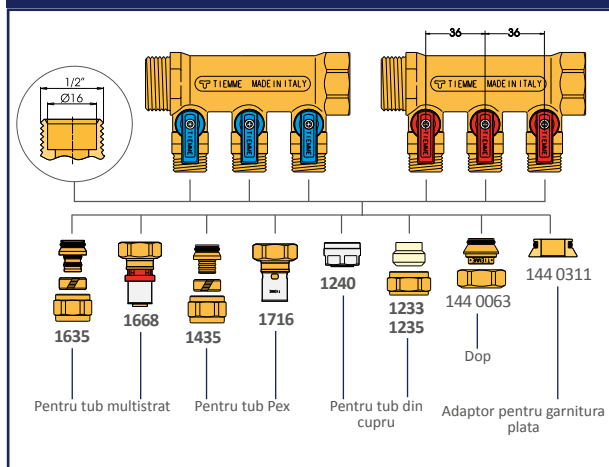

1822RCP 1832RCP GHID DE CONEXIUNI

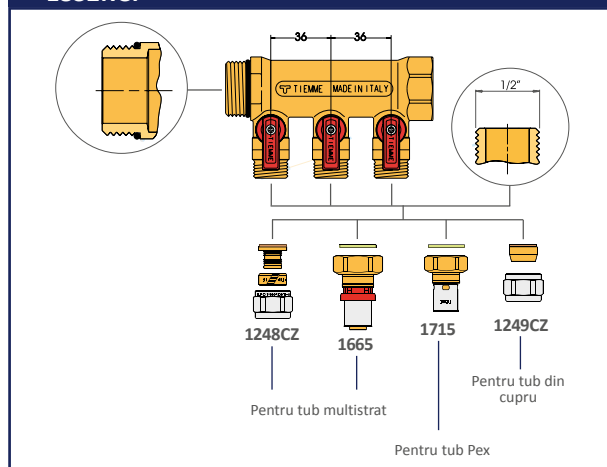

Vezi pagina cu tabelul de rotatii ale piulitei de la sfarsitul capitolului



Utilizare cu caseta 1810, 1812, 1910P, 1920-1930 și 1939-1940 (pag. 216)

**1822RCP50**

Colector "NINO" din alama CW617N cu robineti cu sfera. Interaxa 50 mm și iesiri 1/2" garnitura plata. Filet fazat cu O-ring

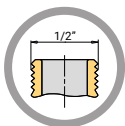

CU FILET M/F FAZATE

Cod	Diametru	Cai	Dimens.	Pret €	Ambalare
maneta tip fluture albastra					
182 0104	3/4"G	2	1/2"		4/32
182 0105	3/4"G	3	1/2"		4/16
182 0106	3/4"G	4	1/2"		4/16
maneta tip fluture rosie					
182 0107	3/4"G	2	1/2"		4/32
182 0108	3/4"G	3	1/2"		4/16
182 0109	3/4"G	4	1/2"		4/16

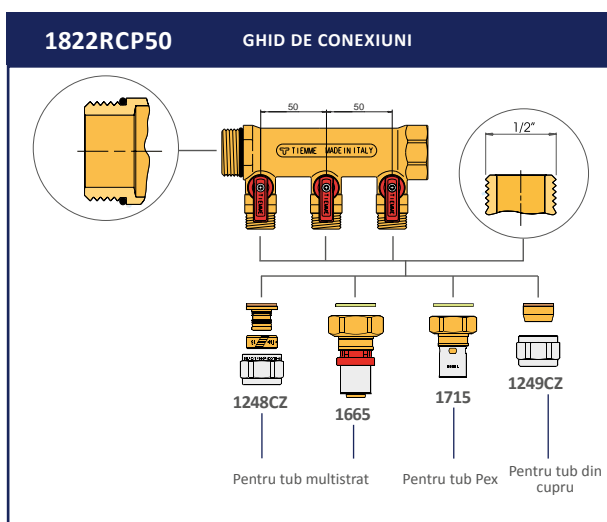

Vezi pagina cu tabelul de rotatii ale piulitei de la sfarsitul capitoului

Utilizare cu caseta 1810, 1812, 1920-1930 și 1939-1940 (pag. 216)



1866K 1868K

Colector cu robineti de oprire "MAXIMA" din alama CW617N cromata. **Interaxa 36 mm** și iesiri 1/2"x16. Filet fazat cu O-ring.

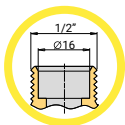

CU FILET M/F FAZATE

Se livrează cu etichete de marcare a tipului de consumator

Cod	Diametru	Cai	Dimens.	Pret €	Ambalare
186 0163	3/4"G	1	1/2"(ø16)		4/32
186 0008	3/4"G	2	1/2"(ø16)		4/32
186 0005	3/4"G	3	1/2"(ø16)		4/16
186 0004	3/4"G	4	1/2"(ø16)		4/16
186 0010	3/4"G	5	1/2"(ø16)		4/16
186 0083	3/4"G	6	1/2"(ø16)		4/12
186 0164	1"G	1	1/2"(ø16)		4/32
186 0022	1"G	2	1/2"(ø16)		4/32
186 0021	1"G	3	1/2"(ø16)		4/16
186 0020	1"G	4	1/2"(ø16)		4/16
186 0028	1" G	5	1/2"(ø16)		4/16
186 0084	1" G	6	1/2"(ø16)		4/12



1868KCOPPIA

Set colectoare premontate cu robineti de oprire, seria "MAXIMA", din alama CW617 N cu **interaxa 36 mm** și iesiri 1/2" x 16

Filet fazat cu O-ring, versiunea Cromata

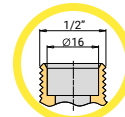

Cod	Diametru	Cai	Dimens.	Pret €	Ambalare
186 0082	1"G	4	1/2"(ø16)		1/1
186 0048	1"G	5	1/2"(ø16)		1/1
186 0049	1"G	6	1/2"(ø16)		1/1
186 0050	1"G	7	1/2"(ø16)		1/1
186 0051	1"G	8	1/2"(ø16)		1/1
186 0052	1"G	9	1/2"(ø16)		1/1
186 0053	1"G	10	1/2"(ø16)		1/1

1866K-1868K 1868KCOPPIA

GHID DE CONEXIUNI

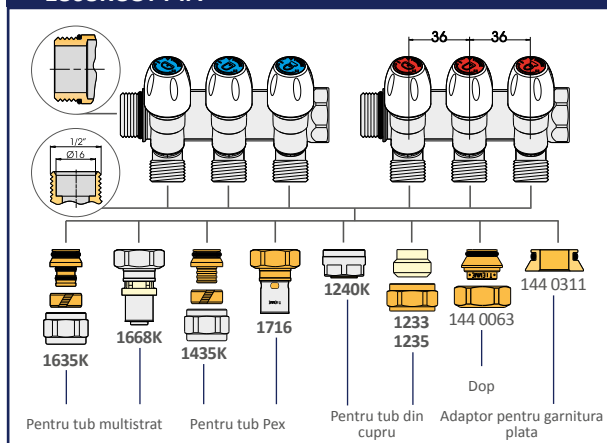

Vezi pagina cu tabelul de rotatii ale piulitei de la sfarsitul capitolului



LISTA DE PREȚURI

Utilizare cu caseta 1810, 1812, 1920-1930 și 1939-1940 (pag. 216)



1866CP

Colectoare MAXIMA din alama CW617N galbena cu iesiri 1/2" garnitura plata. Interaxa 36 mm. Filet fazat cu O-ring

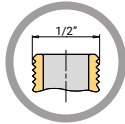

+ CU FILET M/F FAZATE

+ Se livreaza cu etichete de marcare a tipului de consumator

Cod	Diametru	Cai	Dimens.	Pret €	Ambalare
186 0200	3/4"G	2	1/2"		4/32
186 0201	3/4"G	3	1/2"		4/16
186 0202	3/4"G	4	1/2"		4/16



1877K36

Colector cu robineti de oprire MAXIMA din alama cromată CW617N cu interaxa 36 mm și conexiuni filetate 24x19 fil Ø18. Filet fazat cu garnitura.

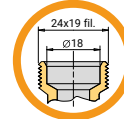

+ CU FILET M/F FAZATE

+ Se livreaza cu etichete de marcare a tipului de consumator

Cod	Diametru	Cai	Dimens.	Pret €	Ambalare
186 0023	3/4"G	2	24 x 19 fil (Ø18)		1/25
186 0018	3/4"G	3	24 x 19 fil (Ø18)		1/25
186 0014	3/4"G	4	24 x 19 fil (Ø18)		1/25
186 0016	3/4"G	5	24 x 19 fil (Ø18)		1/20
186 0085	3/4"G	6	24 x 19 fil (Ø18)		1/15
186 0006	1"G	2	24 x 19 fil (Ø18)		1/25
186 0003	1"G	3	24 x 19 fil (Ø18)		1/25
186 0002	1"G	4	24 x 19 fil (Ø18)		1/20
186 0001	1" G	5	24 x 19 fil (Ø18)		1/20
186 0086	1" G	6	24 x 19 fil (Ø18)		1/15
186 0138	1"1/4G	2	24 x 19 fil (Ø18)		1/20
186 0139	1"1/4G	3	24 x 19 fil (Ø18)		1/20
186 0140	1"1/4G	4	24 x 19 fil (Ø18)		1/15
186 0141	1"1/4G	5	24 x 19 fil (Ø18)		1/15
186 0142	1"1/4G	6	24 x 19 fil (Ø18)		1/10

1866CP

GHID DE CONEXIUNI

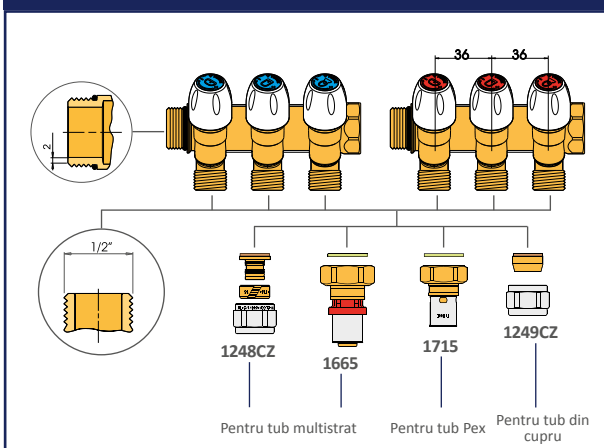

1877K36

GHID DE CONEXIUNI

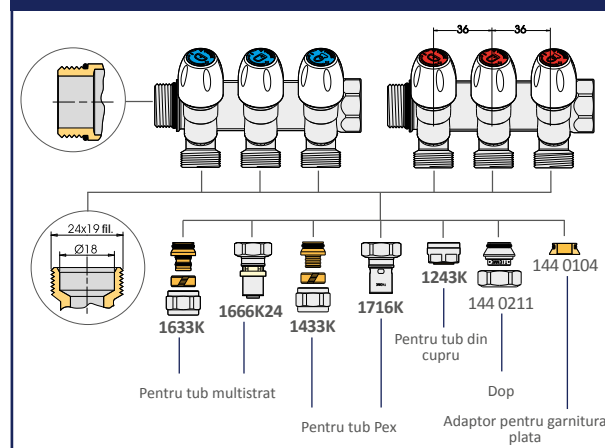

Utilizare cu caseta 1810, 1812, 1920-1930 și 1939-1940 (pag. 216)



1877K50

Colector cu robineti de oprire "MAXIMA" din alama CW617N cromata. **Interaxa 50 mm** și iesiri 3/4"x18 (EUROCONO). Filet fazat cu O-ring.

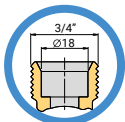

+ CU FILET M/F FAZATE

+ Se livreaza cu etichete de marcare a tipului de consumator

Cod	Diametru	Cai	Dimens.	Pret €	Ambalare
186 0026	3/4"	2	3/4"(Ø18)		4/16
186 0011	3/4"	3	3/4"(Ø18)		4/16
186 0015	3/4"	4	3/4"(Ø18)		4/16
186 0024	1"	2	3/4"(Ø18)		4/16
186 0013	1"	3	3/4"(Ø18)		4/16
186 0019	1"	4	3/4"(Ø18)		4/16



1877K50

Colector cu robineti de oprire "MAXIMA" din alama cromată CW617N cu **interax 50 mm** și conexiuni filetate 24x19 fil Ø18. Filet fazat cu garnitura.

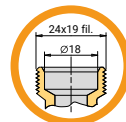

+ CU FILET M/F FAZATE

+ Se livreaza cu etichete de marcare a tipului de consumator

Cod	Diametru	Cai	Dimens.	Pret €	Ambalare
186 0043	3/4"	2	24 x 19 fil (Ø18)		1/25
186 0041	3/4"	3	24 x 19 fil (Ø18)		1/25
186 0044	3/4"	4	24 x 19 fil (Ø18)		1/20
186 0032	1"	2	24 x 19 fil (Ø18)		1/25
186 0031	1"	3	24 x 19 fil (Ø18)		1/25
186 0029	1"	4	24 x 19 fil (Ø18)		1/20

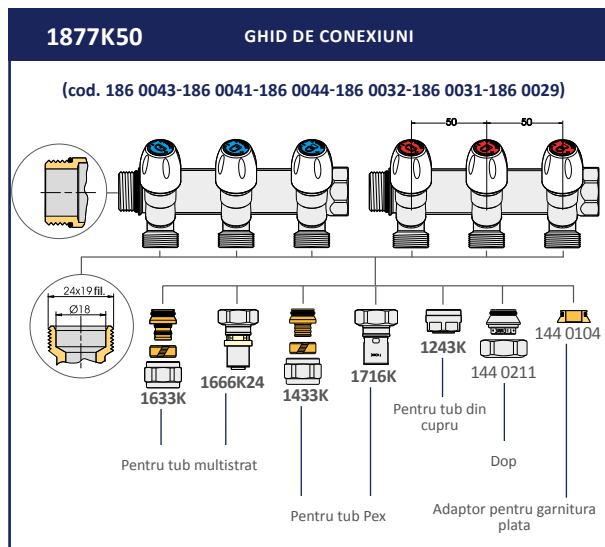
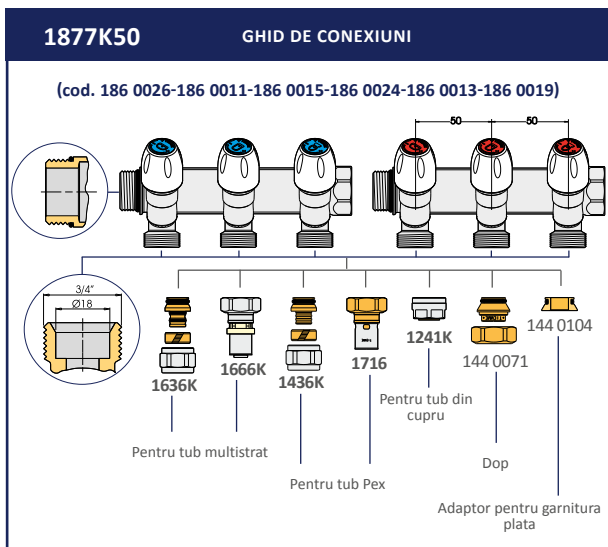

i Vezi pagina cu tabelul de rotatii ale piulitei de la sfarsitul capitolului



Utilizare cu caseta 1810, 1812, 1920-1930 și 1939-1940 (pag. 216)



1871K

Colector cu robineti de oprire "MAXIMA CORNER" din alama CW617N cromata. Interaxa 50 mm. Filet fazat cu O-ring

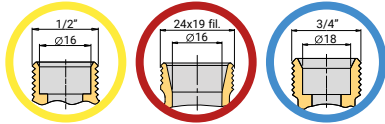

+ CU FILET M/F FAZATE

Cod	Diametru	Cai	Dimens.	Pret €	Ambalare
185 0001	3/4"G	2	1/2"(Ø16)		1/10
185 0002	3/4"G	3	1/2"(Ø16)		1/8
185 0003	3/4"G	4	1/2"(Ø16)		1/8
185 0010	1"G	2	1/2"(Ø16)		1/10
185 0011	1"G	3	1/2"(Ø16)		1/8
185 0012	1"G	4	1/2"(Ø16)		1/8
185 0004	3/4"G	2	24 x 19 fil (Ø16)		1/10
185 0005	3/4"G	3	24 x 19 fil (Ø16)		1/8
185 0006	3/4"G	4	24 x 19 fil (Ø16)		1/8
185 0013	1"G	2	24 x 19 fil (Ø16)		1/10
185 0014	1"G	3	24 x 19 fil (Ø16)		1/8
185 0015	1"G	4	24 x 19 fil (Ø16)		1/8
185 0007	3/4"G	2	3/4"(Ø18)		1/10
185 0008	3/4"G	3	3/4"(Ø18)		1/8
185 0009	3/4"G	4	3/4"(Ø18)		1/8
185 0016	1"G	2	3/4"(Ø18)		1/10
185 0017	1"G	3	3/4"(Ø18)		1/8
185 0018	1"G	4	3/4"(Ø18)		1/8



1632K

Adaptor pentru tub multistrat, pentru conexiuni 24x19fil (Ø16). Versiunea cromata

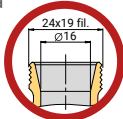

Cod	Dimensiune	Pret €	Ambalare
144 0256	16 x 2,0 - 24 x 19 fil (Ø16)		1/150
144 0257	20 x 2,0 - 24 x 19 fil (Ø16)		1/150

1871K

GHID DE CONEXIUNI

(Cod. 185 0001-185 0002-185 0003-185 0010-185 0011-185 0012)

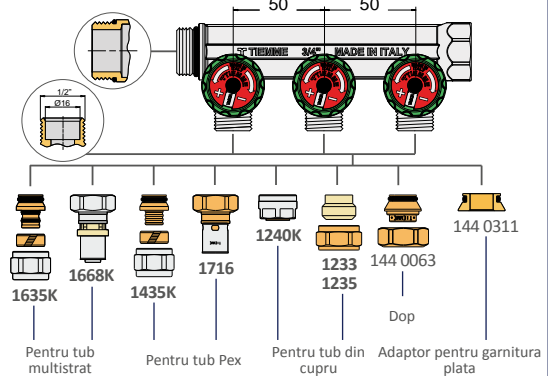

1871K

GHID DE CONEXIUNI

(Cod. 185 0004-185 0005-185 0006-185 0013-185 0014-185 0015)

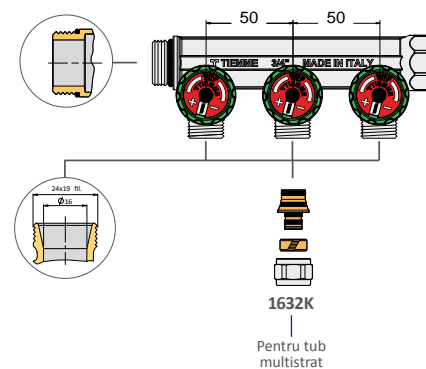

1871K

GHID DE CONEXIUNI

(Cod. 185 0007-185 0008-185 0009-185 0016-185 0017-185 0018)

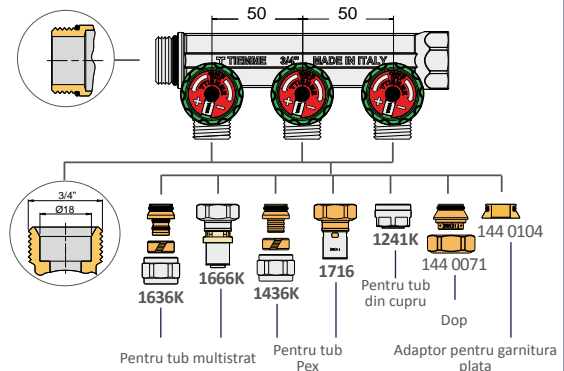

i Vezi pagina cu tabelul de rotatii ale piulței de la sfarsitul capitolului

Utilizare cu caseta 1810, 1812, 1910P, 1920-1930 și 1939-1940 (pag. 216)



1876K50

Colector cu robineti de oprire "MAXIMA VERTI" din alama CW617N cromata. **Interaxa 50 mm** si iesiri 3/4" fil Ø18. Filet fazat cu O-ring.

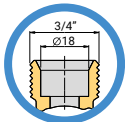

+ CU FILET M/F FAZATE

+ Se livreaza cu etichete de marcare a tipului de consumator

Cod	Diametru	Cai	Dimens.	Pret €	Ambalare
187 0009	1"G	2	3/4"(Ø18)		1/25
187 0010	1"G	3	3/4"(Ø18)		1/25
187 0011	1"G	4	3/4"(Ø18)		1/20



1876K

Colector cu robineti de oprire "MAXIMA VERTI" din alama CW617N cromata. **Interaxa 36 mm** si iesiri 24x19 fil Ø18. Filet fazat cu O-ring.

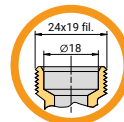

+ CU FILET M/F FAZATE

+ Se livreaza cu etichete de marcare a tipului de consumator

Cod	Diametru	Cai	Dimens.	Pret €	Ambalare
187 0008	3/4"G	2	24 x 19 fil (Ø18)		1/25
187 0007	3/4"G	3	24 x 19 fil (Ø18)		1/25
187 0006	3/4"G	4	24 x 19 fil (Ø18)		1/25
187 0005	3/4"G	5	24 x 19 fil (Ø18)		1/25
187 0004	1"G	2	24 x 19 fil (Ø18)		1/25
187 0001	1"G	3	24 x 19 fil (Ø18)		1/25
187 0002	1"G	4	24 x 19 fil (Ø18)		1/25
187 0003	1"G	5	24 x 19 fil (Ø18)		1/20

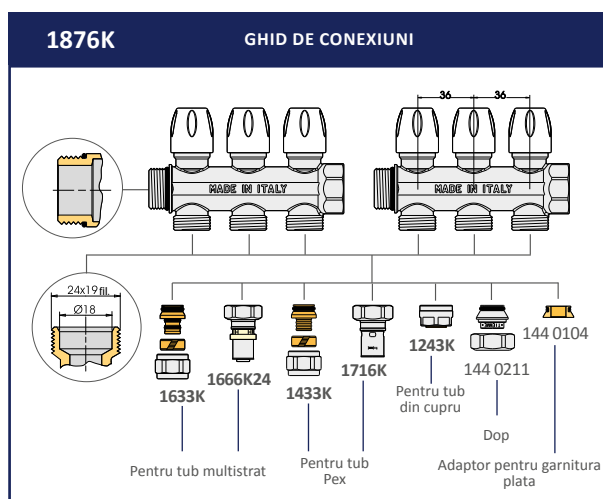
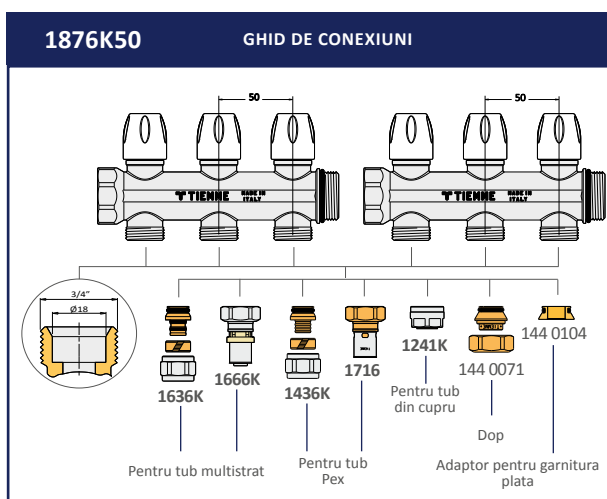

i Vezi pagina cu tabelul de rotatii ale piulitei de la sfarsitul capitoului





H9302

O-Ring pentru etansare

Cod	Dimensiune	Pret €	Ambalare
040 0109	3/4"		50/600
040 0110	1"		50/500

GHID DE ACCESORII PENTRU COLECTOARELE CU FILET FAZAT MASCULIN/FEMININ

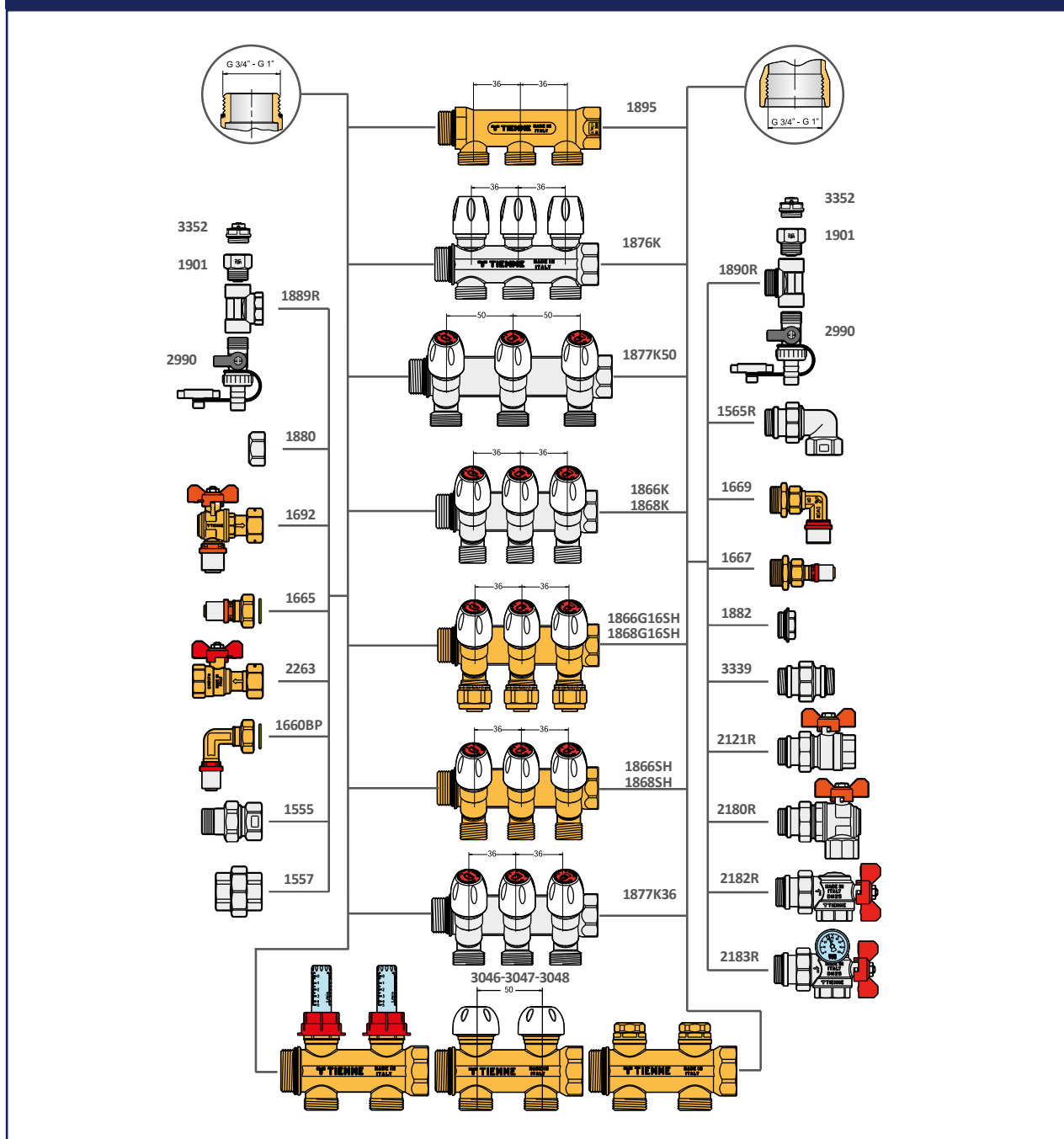

EXEMPLU DE MONTAJ PENTRU COLECTOARE CU FILET FAZAT MASCULIN/FEMININ

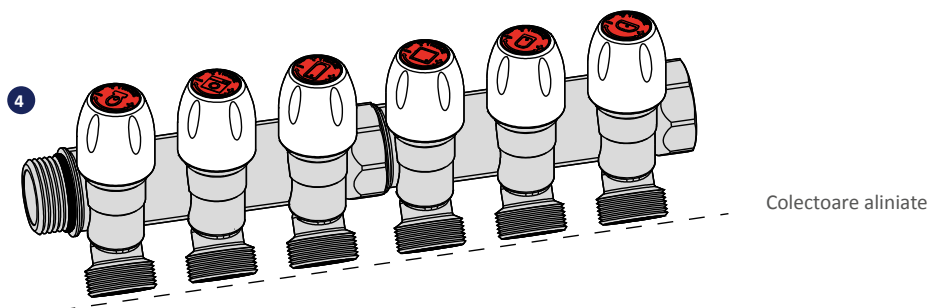
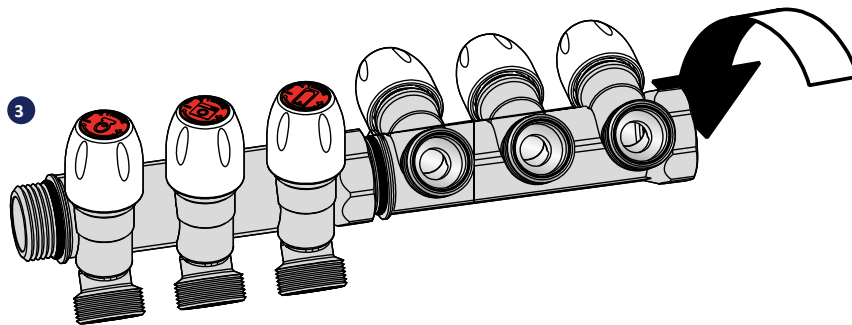
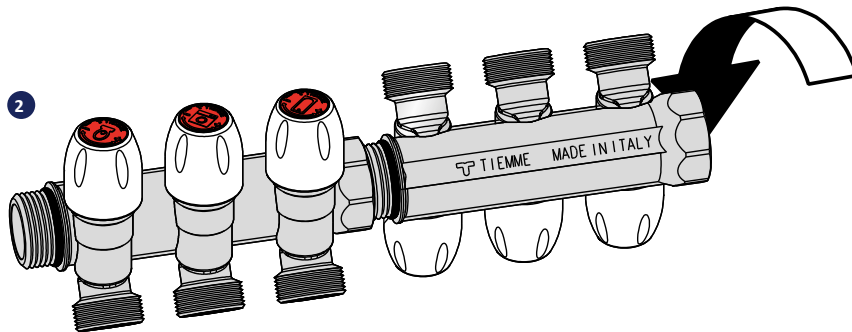
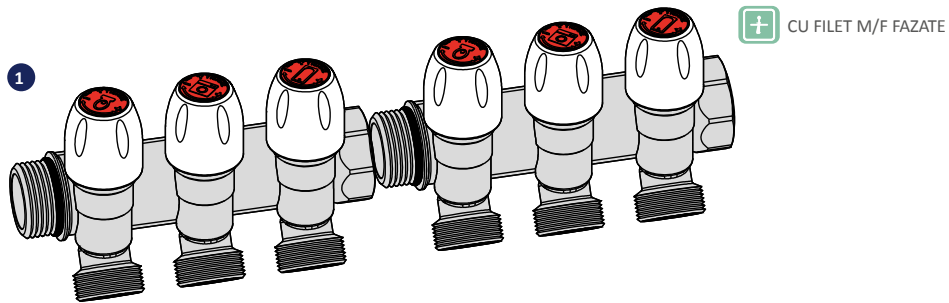



3023

Distribuitoare liniare compacte asamblate în cutii complete cu rozete cromate și capace cu robineti de închidere

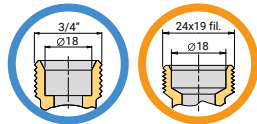

BREVETAT

3 cai apa rece si 3 cai apa calda pe aceeasi parte

Cod	Dimensiune	Pret €	Ambalare
304 0152	295 x 226 x 77		1/1



3023RAC

Cot dublu pentru caseta SANIBOX ART.3023

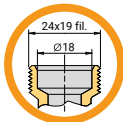

Cod	Dimensiune	Pret €	Ambalare
179 0337	1/2" - 24 x 19 fil (Ø18)		10/100

TUTORIAL VIDEO



Colectoare de distributie pre-asamblate in cutie "SANIBOX"

Vezi pagina cu tabelul de rotatii ale piulitei de la sfarsitul capitoului

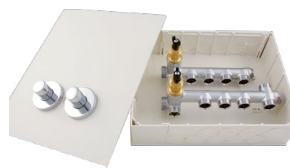

3033

Colectoare lineare premontate cu rozete, capace cromate si robineti de inchidere in caseta PVC

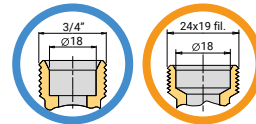

BREVETAT

6 cai apa rece si 4 cai apa calda pe aceeasi parte

Cod	Dimensiune	Pret €	Ambalare
304 0007	295 x 226 x 77		1/1



3035

Colectoare lineare premontate cu rozete, capace cromate si robineti de inchidere in caseta PVC

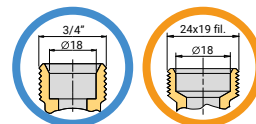

BREVETAT

6 cai apa rece si 4 cai apa calda pe parti opuse

Cod	Dimensiune	Pret €	Ambalare
304 0008	295 x 226 x 77		1/1

3023-3033-3035

GHID DE CONEXIUNI

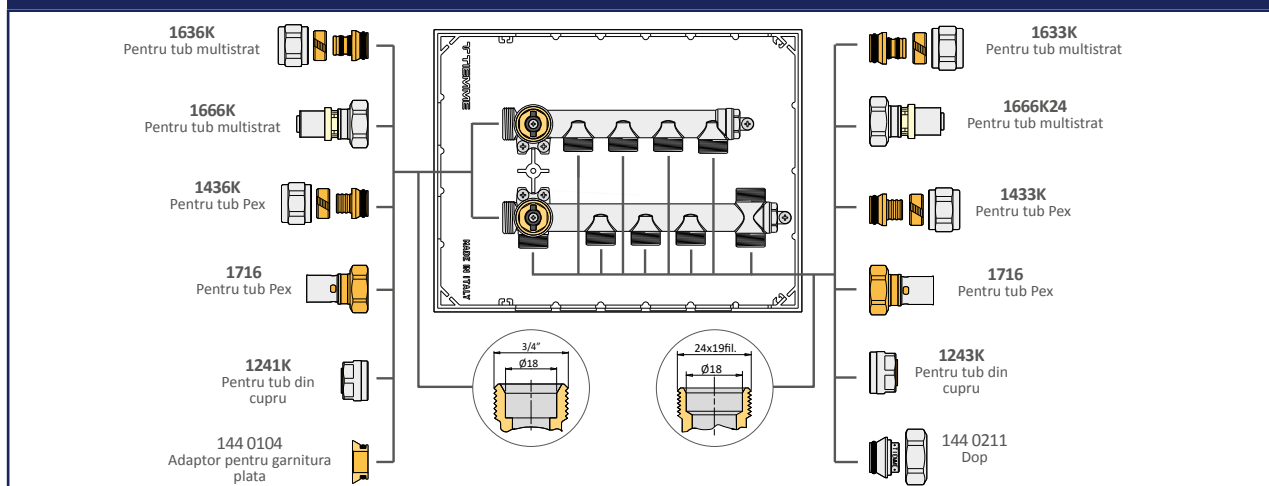

**3023**

3 CAI APA RECE SI 3 CAI APA CALDA PE ACEEASI PARTE

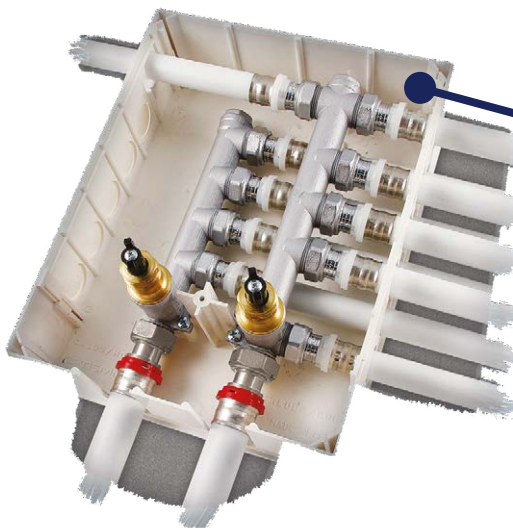
**3033**

6 CAI APA RECE SI 4 CAI APA CALDA PE ACEEASI PARTE

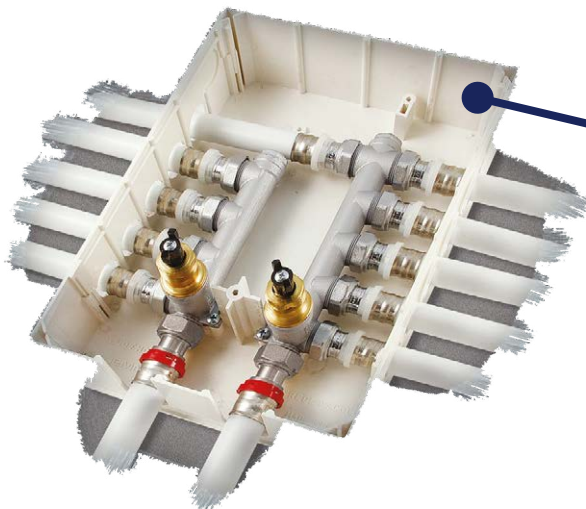
**3035**

6 CAI APA RECE SI 4 CAI APA CALDA PE LATURI OPUSE



LISTA DE PREȚURI

Utilizare cu caseta 1810, 1812, 1910P, 1920-1930 și 1939-1940 (pag. 216)



1912 1922

Colector "LINEARE" din alama CW617N. Interaxa 36 mm și iesiri 1/2"x16

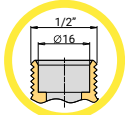

Disponibila la cerere versiunea nichelata

Cod	Diametru	Cai	Dimens.	Pret €	Ambalare
191 0004	3/4"G	2	1/2"(ø16)		1/50
191 0002	3/4"G	3	1/2"(ø16)		1/40
191 0001	3/4"G	4	1/2"(ø16)		1/30
191 0003	3/4"G	5	1/2"(ø16)		1/25
191 0020	1"G	2	1/2"(ø16)		1/40
191 0007	1"G	3	1/2"(ø16)		1/30
191 0005	1"G	4	1/2"(ø16)		1/25
191 0011	1"G	5	1/2"(ø16)		1/20



1912R

Colector "LINEARE" din alama CW617N. Interaxa 36 mm și iesiri 1/2"x16. Filet fazat cu O-ring

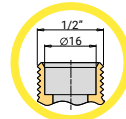

CU FILET M/F FAZATE

Cod	Diametru	Cai	Dimens.	Pret €	Ambalare
191 0192	3/4"G	2	1/2"(ø16)		1/50
191 0193	3/4"G	3	1/2"(ø16)		1/40
191 0194	3/4"G	4	1/2"(ø16)		1/30
191 0195	3/4"G	5	1/2"(ø16)		1/25

1912-1912R 1922

GHID DE CONEXIUNI

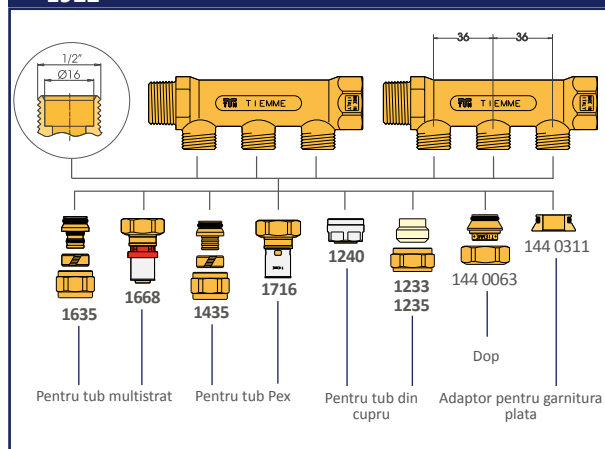

Vezi pagina cu tabelul de rotatii ale piulței de la sfarsitul capitoului

Utilizare cu caseta 1810, 1812, 1910P, 1920-1930 și 1939-1940 (pag. 216)



1883
1884
1885

Colector "LINEARE" din alama CW617N. Interaxa 50 mm și iesiri 3/4"x18 (EUROCONO)

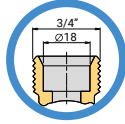

Cod	Diametru	Cai	Dimens.	Pret €	Ambalare
191 0024	3/4"G	2	3/4"(ø18)		1/40
191 0017	3/4"G	3	3/4"(ø18)		1/30
191 0022	3/4"G	4	3/4"(ø18)		1/20
191 0026	1"G	2	3/4"(ø18)		1/30
191 0008	1"G	3	3/4"(ø18)		1/25
191 0015	1"G	4	3/4"(ø18)		1/15
191 0028	1"1/4G	2	3/4"(ø18)		1/25
191 0016	1"1/4G	3	3/4"(ø18)		1/15
191 0014	1"1/4G	4	3/4"(ø18)		1/10



1885ISOL

Izolatie pentru colectoare cu interax 50 mm art.1885

Cod	Cai	Dimensiune	Pret €	Ambalare
557 0688	2	1"1/4		1/4
557 0689	3	1"1/4		1/2
557 0690	4	1"1/4		1/2

1883-1884
1885

GHID DE CONEXIUNI

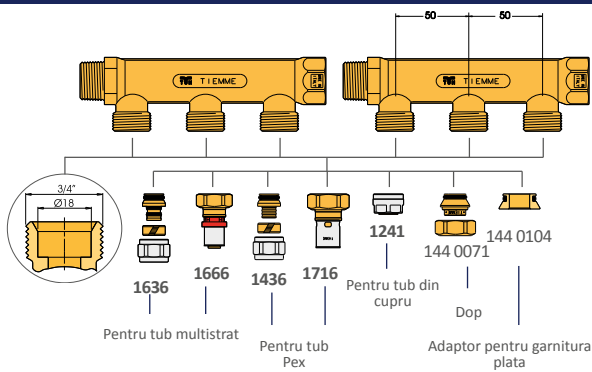

i Vezi pagina cu tabelul de rotatii ale piulitei de la sfarsitul capitolului



1895

Colector "LINEARE" din alama CW617N. Interaxa 36 mm și iesiri 24x19 fil (ø18). Filet fazat cu O-ring.

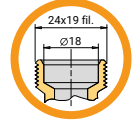

+ CU FILET M/F FAZATE

i Disponibil în versiune cromată

Cod	Diametru	Cai	Dimens.	Pret €	Ambalare
191 0079	3/4"G	2	24 x 19 fil (ø18)		1/50
191 0072	3/4"G	3	24 x 19 fil (ø18)		1/40
191 0070	3/4"G	4	24 x 19 fil (ø18)		1/30
191 0067	3/4"G	5	24 x 19 fil (ø18)		1/25
191 0084	1"G	2	24 x 19 fil (ø18)		1/40
191 0085	1"G	3	24 x 19 fil (ø18)		1/30
191 0086	1"G	4	24 x 19 fil (ø18)		1/25
191 0087	1"G	5	24 x 19 fil (ø18)		1/20

1895

GHID DE CONEXIUNI

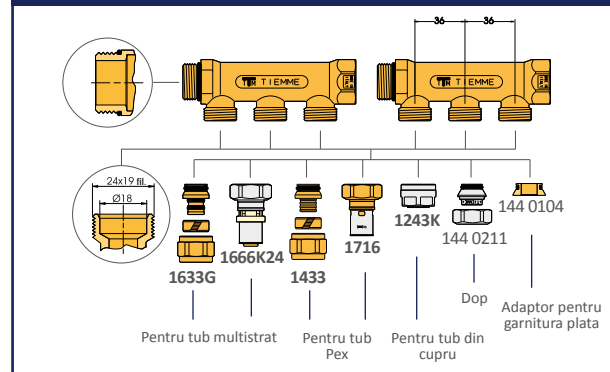

Utilizare cu caseta 1812, 1939-1940 (pag. 216)



3046

Colector de distributie "FLOOR" din alama CW617N cu robineti termostaticabili. Filet fazat cu O-ring.

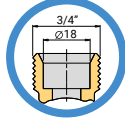

+ CU FILET M/F FAZATE

Cod	Diametru	Cai	Dimens.	Pret €	Ambalare
304 0015	1"G	2	3/4"(ø18)		1/10
304 0011	1"G	3	3/4"(ø18)		1/10
304 0010	1"G	4	3/4"(ø18)		1/6
304 0133	1"1/4 G	2	3/4"(ø18)		1/10
304 0134	1"1/4 G	3	3/4"(ø18)		1/10
304 0135	1"1/4 G	4	3/4"(ø18)		1/6



3048

Colector de distributie "FLOOR" din alama CW617N cu robineti cu memorie mecanica. Filet fazat cu O-ring.

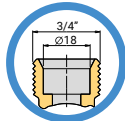

+ CU FILET M/F FAZATE

Cod	Diametru	Cai	Dimens.	Pret €	Ambalare
304 0016	1"G	2	3/4"(ø18)		1/10
304 0014	1"G	3	3/4"(ø18)		1/10
304 0013	1"G	4	3/4"(ø18)		1/6
304 0139	1"1/4 G	2	3/4"(ø18)		1/10
304 0140	1"1/4 G	3	3/4"(ø18)		1/10
304 0141	1"1/4 G	4	3/4"(ø18)		1/6



3047

Colector de distributie "FLOOR" din alama CW617N cu debitmetre pentru masurarea si reglarea fluxului. Filet fazat cu O-ring.

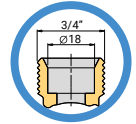

+ CU FILET M/F FAZATE

Cod	Diametru	Cai	Dimens.	Pret €	Ambalare
304 0017	1"G	2	3/4"(ø18)		1/10
304 0012	1"G	3	3/4"(ø18)		1/10
304 0009	1"G	4	3/4"(ø18)		1/6
304 0136	1"1/4 G	2	3/4"(ø18)		1/10
304 0137	1"1/4 G	3	3/4"(ø18)		1/10
304 0138	1"1/4 G	4	3/4"(ø18)		1/6

i Caseta 1812 si 1939 potrivita doar pentru colectoare de 1"

i Vezi pagina cu tabelul de rotatii ale piulitei de la sfarsitul capitolului

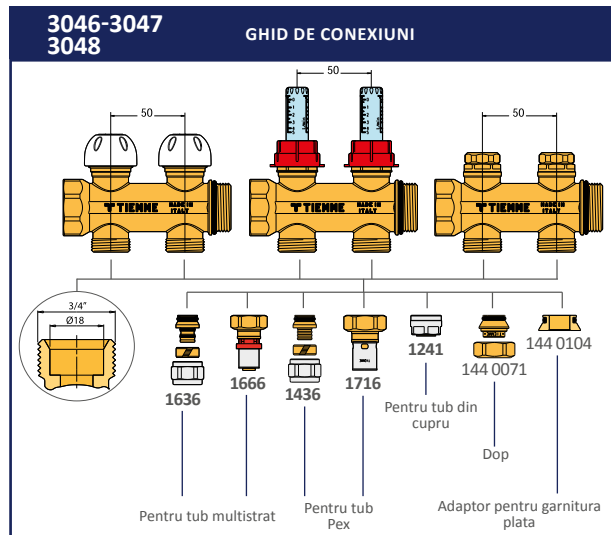

Utilizare cu caseta 1941 (pag. 217)



3053

Colector de distributie "INDUSTRIAL FLOOR" din alama CW617N cu robineti manuali de reglare si filet fazat cu o-ring

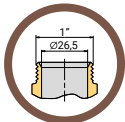

+ CU FILET M/F FAZATE

Cod	Diametru	Cai	Dimensiune	Pret €	Ambalare
304 0027	1"1/2 G	2	1" G (Ø26,5)		1/10
304 0028	1"1/2 G	3	1" G (Ø26,5)		1/10



3054

Colector de distributie "INDUSTRIAL FLOOR" din alama CW617N cu filet fazat cu o-ring

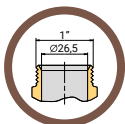

+ CU FILET M/F FAZATE

Cod	Diametru	Cai	Dimensiune	Pret €	Ambalare
304 0029	1"1/2 G	2	1" G (Ø26,5)		1/10
304 0030	1"1/2 G	3	1" G (Ø26,5)		1/10



3055

Colector de distributie "INDUSTRIAL FLOOR" din alama CW617N cu robineti termostaticizabili. Filet fazat cu O-ring



+ CU FILET M/F FAZATE

Cod	Diametru	Cai	Dimensiune	Pret €	Ambalare
304 0155	1"1/2 G	2	1" G (Ø26,5)		1/10
304 0156	1"1/2 G	3	1" G (Ø26,5)		1/10



1436N06

Pentru tub PEX
Adaptor pentru conexiuni 1"

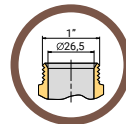

Cod	Dimensiune	Pret €	Ambalare
144 0232	20 x 2,0 - 1" G (Ø26,5)		10/200
144 0075	25 x 2,3 - 1" G (Ø26,5)		10/200



3874P

Capac de protectie

Cod	Dimensiune	Pret €	Ambalare
179 0037	-		5/50

3053-3054 3055

GHID DE CONEXIUNI

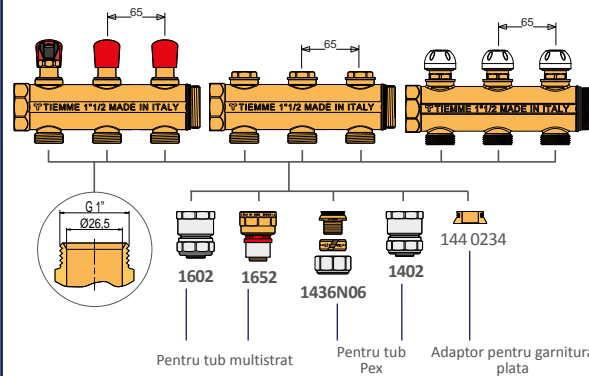

**9567KIT**

Adaptor "INDUSTRIAL FLOOR"
pentru servocomanda
electrotermica 9567

Accesoriu pentru art.3054

Piesa de schimb pentru art.3055

Cod	Dimensiune	Pret €	Ambalare
179 0328	-		1/100

9567-9567KIT

INSTRUCIUNI DE MONTAJ

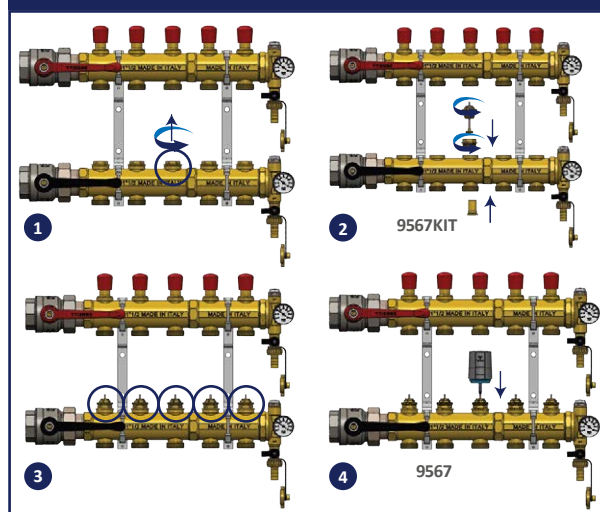

ACESORII PENTRU COLECTOARE

Robineti cu sfera trecere totala

**2121R**

Robinet drept cu olandez si
O-RING, cu pre-etansare

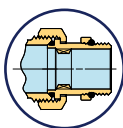

Cod	Dimensiune	Pret €	Ambalare
	maneta tip fluture rosie		
212 0017	3/4"		10/40
212 0013	1"		9/36
212 0027	1"1/4		6/24
	maneta tip fluture albastra		
212 0020	3/4"		10/40
212 0014	1"		9/36
212 0028	1"1/4		6/24

**2182R**

Robinet M/F de colt ISO 228
cu maneta tip fluture pentru
colectoare, cu etansare si
prindere pe O-RING,
cu pre-etansare

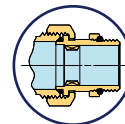



Cod	Dimensiune	Pret €	Ambalare
	maneta tip fluture rosie		
212 0050	3/4"		10/40
212 0048	1"		5/20
	maneta tip fluture albastra		
212 0049	3/4"		10/40
212 0044	1"		5/20

Robineti cu sfera trecere totala

**2180CPR**

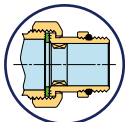
Robinet de colt cu olandez si garnitura O-RING.
GARNITURA PLATA, cu pre-etansare





Cod	Dimensiune	Pret €	Ambalare
 maneta tip fluture rosie			
212 0056	3/4"		10/40
212 0057	1"		5/20
 maneta tip fluture albastra			
212 0054	3/4"		10/40
212 0045	1"		5/20

**2181CPR**

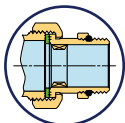
Robinet de colt cu olandez si garnitura O-RING pentru tub multistrat, cu pre-etansare.
GARNITURA PLATA





Cod	Dimensiune	Pret €	Ambalare
 maneta tip fluture rosie			
162 0045	20 x 3/4"		10/40
162 0014	26 x 3/4"		10/40
162 0010	26 x 1"		5/20
162 0015	32 x 1"		5/20
 maneta tip fluture albastra			
162 0046	20 x 3/4"		10/40
162 0004	26 x 3/4"		10/40
162 0009	26 x 1"		5/20
162 0013	32 x 1"		5/20

La cerere

**2120R**

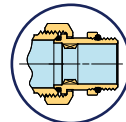
Robinet drept cu olandez, garnitura o-ring si termometru cu prindere reversibila, cu pre-etansare



 **BREVETAT**

Cod	Dimensiune	Pret €	Ambalare
 maneta tip fluture rosie			
212 0043	1"		5/20
 maneta tip fluture albastra			
212 0042	1"		5/20

**2183R**

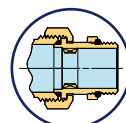
Robinet M/F de colt ISO 228 cu maneta tip fluture, cu pre-etansare, garnitura O-RING si termometru cu prindere reversibila

 **BREVETAT**

Cod	Dimensiune	Pret €	Ambalare
 maneta tip fluture rosie			
212 0031	1"		5/20
 maneta tip fluture albastra			
212 0032	1"		5/20

 Pentru gama completă de supape cu bilă, vezi capitolul 1 A

LISTA DE PREȚURI

Robineti cu sfera trecere totala

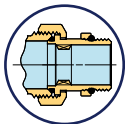
**2121RSAC**Robinet drept cu olandez si O-RING, cu pre-etansare

i Nr 1 cu maneta tip fluture de culoare albastra + Nr 1 cu maneta tip fluture de culoare rosie

Cod	Dimensiune	Pret €	Ambalare
386 0035	1"G		1/10

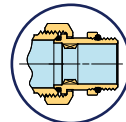
**2182RSAC**Robinet M/F de colt ISO 228 cu maneta tip fluture pentru colectoare, cu etansare si prindere pe O-RING, cu pre-etansare

i Nr 1 cu maneta tip fluture de culoare albastra + Nr 1 cu maneta tip fluture de culoare rosie

Cod	Dimensiune	Pret €	Ambalare
386 0032	1"G		1/10

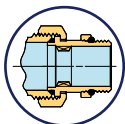
**2182**Robinet M/F de colt ISO 228 cu maneta tip fluture pentru colectoare si etansare pe O-RING

Cod	Dimensiune	Pret €	Ambalare
-----	------------	--------	----------

**maneta tip fluture rosie**

212 0046	1/2"		15/60
212 0038	3/4"		10/40
212 0040	1"		5/20

**maneta tip fluture albastra**

212 0047	1/2"		15/60
212 0039	3/4"		10/40
212 0041	1"		5/20

Robineti cu bilă compacte

**2114CPRKIT**

Set robineti sfera cu olandez garnitura plata model drept compact, cu maneta tip fluture culoare rosie si albastra si termometre ce au conexiune reversibila

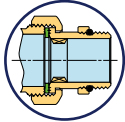

 BREVETAT

Cod	Dimensiune	Pret €	Ambalare
212 0195	1"		1/10

**2184CPRKIT**

Set robineti sfera cu olandez garnitura plata model coltar compact, cu maneta tip fluture culoare rosie si albastra si termometre ce au conexiune reversibila

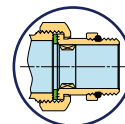

 BREVETAT

Cod	Dimensiune	Pret €	Ambalare
212 0197	1"		1/10

**2116CPRKIT**

Set robineti sfera cu olandez garnitura plata model drept compact, cu maneta tip fluture culoare rosie si albastra fara termometre

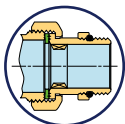

 BREVETAT

Cod	Dimensiune	Pret €	Ambalare
212 0196	1"		1/10

**2186CPRKIT**

Set robineti sfera cu olandez garnitura plata model coltar compact, cu maneta tip fluture culoare rosie si albastra fara termometre

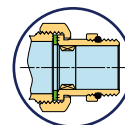

 BREVETAT

Cod	Dimensiune	Pret €	Ambalare
212 0198	1"		1/10



**9567**

Servocomanda electrotermica pentru robinet termostaticabil de inchidere cu indicator de cursa.

NORMAL INCHIS

Cod	Dimensiune	Pret €	Ambalare
450 0026	24V		1/20
450 0012	230V		1/20
450 0045	24V		1/20
450 0006	230V		1/20

Versiuni cu microinterruptor auxiliar

**2990G**

Robinet cu sfera pentru golire



Cod	Dimensiune	Pret €	Ambalare
295 0024	3/8"		25/100
295 0001	1/2"		25/100
295 0040	1/2"		10/50

Versiune cu lant metalic

**H8996**

Stut pentru termometru

Cod	Dimensiune	Pret €	Ambalare
040 0088	3/8"		1/100

**2070**

Termometru \varnothing 40 L=30 mm scara 0 ÷ 80°C

Cod	Dimensiune	Pret €	Ambalare
179 0006	-		10/50

**H9709**

Indicatoare de debit pentru Colector de distributie FLOOR

Cod	Dimensiune	Pret €	Ambalare
040 0196	-		5/100

**H9708**

Ventil termostaticabil pentru colector de distributie FLOOR

Cod	Dimensiune	Pret €	Ambalare
040 0241	1"		10/50
040 0287	1"1/4		10/50

Noutati

**1886**

Racord drept M/F

Disponibila la cerere versiunea nichelata

Cod	Dimensiune	Pret €	Ambalare
195 0021	1/2" x 3/4"		10/200

**1887**

Racord drept M/M cu garnitura O-ring pentru colectoare

Disponibila la cerere versiunea nichelata

Cod	Dimensiune	Pret €	Ambalare
195 0018	3/4" - 1/2" x 16		10/250

**1890**

Racord terminal pentru colectoare cu iesiri de 3/8" si 1/2"

i Disponibila la cerere versiunea nichelata

Cod	Dimensiune	Pret €	Ambalare
195 0009	3/4"		10/130
195 0001	1"		5/90
195 0006	1"1/4		5/60

**1889R**

Racord terminal F cu filet fazat

Cod	Dimensiune	Pret €	Ambalare
195 0044	3/4" x 1/2" x 1/2"		10/100
195 0039	1" x 1/2" x 1/2"		10/100
Versiunea cromata			
195 0031	3/4" x 1/2" x 1/2"		10/100
195 0010	1" x 1/2" x 1/2"		10/100

**1890R**

Racord terminal M cu filet fazat si O-ring

Cod	Dimensiune	Pret €	Ambalare
195 0054	3/4" x 1/2" x 1/2"		10/100
195 0040	1" x 1/2" x 1/2"		10/100
Versiunea cromata			
195 0051	3/4" x 1/2" x 1/2"		10/100
195 0026	1" x 1/2" x 1/2"		10/100

**1880**

Dop F pentru colectoare

i Disponibila la cerere versiunea nichelata si cromata

Cod	Dimensiune	Pret €	Ambalare
150 0342	3/8"		25/200
150 0058	1/2"		25/200
150 0041	3/4"		10/100
150 0108	1"		10/100
150 0285	1"1/4		5/100
150 0327	1"1/2		5/60
150 0751	2"		2/50

**1878**

Dop M pentru colectoare

i Disponibila la cerere versiunea nichelata

Cod	Dimensiune	Pret €	Ambalare
150 0273	3/8"		25/200
150 0040	1/2"		25/300
150 0019	3/4"		10/150
150 0077	1"		10/100
150 0222	1"1/4		5/100
150 0865	1"1/2		5/50
150 0866	2"		2/40

**1881**

Reductie M/F cu garnitura O-ring pentru colectoare

i Disponibila la cerere versiunea nichelata

Cod	Dimensiune	Pret €	Ambalare
195 0013	3/4" x 3/8"		10/300
195 0019	3/4" x 1/2"		10/300
195 0020	1" x 3/8"		10/200
195 0005	1" x 1/2"		10/200
195 0008	1" x 3/4"		10/200
195 0034	1"1/4 x 3/8"		10/150
195 0017	1"1/4 x 1/2"		10/150
195 0066	1"1/2 x 3/4"		5/70



**1882**

Dop M cu garnitura O-ring
pentru colectoare

i Disponibila la cerere versiunea nichelata si cromata

Cod	Dimensiune	Pret €	Ambalare
195 0016	1/2"		10/500
195 0004	3/4"		10/400
195 0002	1"		10/200
195 0007	1"1/4		10/150
195 0041	1"1/2		5/70
195 0052	2"		2/40

**3339**

Racord de legatura 3 piese M/M
cu O-ring

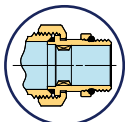

Cod	Dimensiune	Pret €	Ambalare
195 0036	3/4"		1/40
195 0027	1"		1/35
195 0043	1"1/4		1/30

**3341**

Racord drept M/M cu O-ring si
inel de strangere

Cod	Dimensiune	Pret €	Ambalare
195 0046	3/4"		1/100
195 0029	1"		1/35
195 0035	1"1/4		1/30

**1513**

Excentric cu ampatament 15
mm M/F

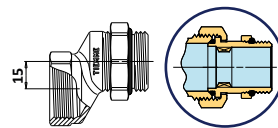

Cod	Dimensiune	Pret €	Ambalare
150 0444	1"		2/50

**1514**

Excentric cu ampatament 25
mm M/F

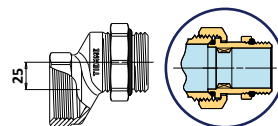

Cod	Dimensiune	Pret €	Ambalare
150 0672	1"		2/40

**1872**

Maneta "NINO"

Cod	Dimensiune	Pret €	Ambalare
179 0005	albastru		50/500
179 0007	rosie		50/500

**1892**

Cheie pentru racorduri

Cod	Dimensiune	Pret €	Ambalare
164 0029	Ch 23-27		5/40
1640053	Ch 24-27		5/40
164 0016	Ch 24-30		5/40

■ pentru 1240-1241-1243

■ pentru seria 1600 si 1241-1243-1433-1435-1635

■ pentru seria 1600 si 1436-1635-1636

**1896**

Supapa automata de aerisire nichelata

Cod	Dimensiune	Pret €	Ambalare
198 0068	1/2"		1/20
198 0074	3/4"		1/20

Filet masculin cu O-ring

**1896GG**

Ansamblu Flotor pentru supapele de aerisire automate 1896

Cod	Dimensiune	Pret €	Ambalare
198 0070	-		1/20

**1914**

Supapa automata de aerisire cu racord lateral cu corp de 39 mm nichelata

Cod	Dimensiune	∅	Pret €	Ambalare
198 0126	3/8"	39		1/50
198 0127	1/2"	39		1/50

**1913**

Supapa automata de aerisire nichelata

Cod	Dimensiune	∅	Pret €	Ambalare
198 0128	3/8"	39		1/50
198 0129	1/2"	39		1/50

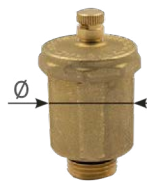
**1913G**

Supapa automata de aerisire

Cod	Dimensiune	∅	Pret €	Ambalare
198 0130	3/8"	39		1/50
198 0131	1/2"	39		1/50

**1898**

Supapa automata de aerisire laterala

Cod	Dimensiune	∅	Pret €	Ambalare
198 0005	3/8"	39		1/50
198 0004	1/2"	39		1/50

**1898G34**

Supapa automata de aerisire laterala cu corp de 34 mm

Cod	Dimensiune	∅	Pret €	Ambalare
198 0114	3/8"	34		1/70
198 0092	1/2"	34		1/70

**1898KIT34**

Set Supapa automata de aerisire + Supapa de blocare

 Kit format din 1898G34+1901P

Cod	Dimensiune	∅	Pret €	Ambalare
198 0112	3/8"	34		1/70
198 0113	1/2"	34		1/70



**1899**

Supapa automata de aerisire cu racord lateral

Cod	Dimensiune	Ø	Pret €	Ambalare
198 0011	3/8"	39		1/50
198 0003	1/2"	39		1/50

Până la terminarea stocului

**1900**

Supapa automata de aerisire

Cod	Dimensiune	Ø	Pret €	Ambalare
198 0002	3/8"	39		1/50
198 0001	1/2"	39		1/50
198 0013	3/4"	45,5		1/25
198 0022	1"	45,5		1/25

Până la terminarea stocului

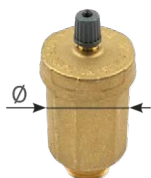
**1900G**

Supapa automata de aerisire

Cod	Dimensiune	Ø	Pret €	Ambalare
198 0014	3/8"	39		1/50
198 0007	1/2"	39		1/50

Până la terminarea stocului

**1900N34**

Supapa automata de aerisire

Cod	Dimensiune	Ø	Pret €	Ambalare
198 0024	3/8"	34		1/40
198 0029	1/2"	34		1/40

**1900G34**

Supapa automata de aerisire

Cod	Dimensiune	Ø	Pret €	Ambalare
198 0017	3/8"	34		1/40
198 0019	1/2"	34		1/40

**1901**

Supapa de blocare cu garnitura de etansare si obturator din alama

Cod	Dimensiune	Pret €	Ambalare
198 0012	3/8"		10/300
198 0009	1/2"		10/100
198 0023	M 1/2" - F 3/8"		10/300

**1901P**

Supapa de blocare cu garnitura de etansare si obturator din plastic

Cod	Dimensiune	Pret €	Ambalare
198 0106	3/8"		10/300
198 0108	1/2"		10/300
198 0110	M 1/2" - F 3/8"		10/300

**1901PN**

Supapa de blocare nichelata cu garnitura de etansare si obturator din plastic

Cod	Dimensiune	Pret €	Ambalare
198 0107	3/8"		10/300
198 0109	1/2"		10/300
198 0111	M 1/2" - F 3/8"		10/300

La cerere

**1812**

Caseta universala cu seturi de fixare pentru colectoare "NINO", "LINEARE", "MAXIMA", "MAXIMA CORNER", "RUBINO" si "MAXIMA VERTI"

i Pentru colectoare bara se va folosi setul de prindere 1805

Cod	Dimensiune	Pret €	Ambalare
181 0129	310 x 295 x 80		1/5
181 0130	420 x 295 x 80		1/5
181 0131	510 x 295 x 80		1/5
181 0181	620 x 295 x 80		1/5

**1810**

Caseta universala

i Set de prindere vezi 1807-1808

Cod	Dimensiune	Pret €	Ambalare
181 0014	300 x 250 x 80		1/10
181 0008	400 x 250 x 80		1/10

**1910P**

Caseta universala pentru colectoare "NINO" si "LINEARE"

Cod	Dimensiune	Pret €	Ambalare
181 0017	400 x 240 x 80		1/19
181 0018	500 x 240 x 80		1/14
181 0021	600 x 240 x 80		1/12

**1920**
1930

Caseta universala din metal

i Set de prindere vezi 1807-1808

Cod	Dimensiune	Pret €	Ambalare
181 0028	400 x 280 x 90		1/1
181 0026	500 x 280 x 90		1/1
181 0031	600 x 280 x 90		1/1
181 0027	500 x 450 x 90		1/1
181 0029	600 x 450 x 90		1/1
181 0037	700 x 450 x 90		1/1
181 0036	800 x 450 x 90		1/1

**1931**

Caseta din metal prevazuta cu set de prindere pentru kit de amestec

i Adancime reglabila de la 120 mm la 170 mm

Cod	Dimensiune	Pret €	Ambalare
181 0132	600 x 670 x 120 ÷ 170		1/1

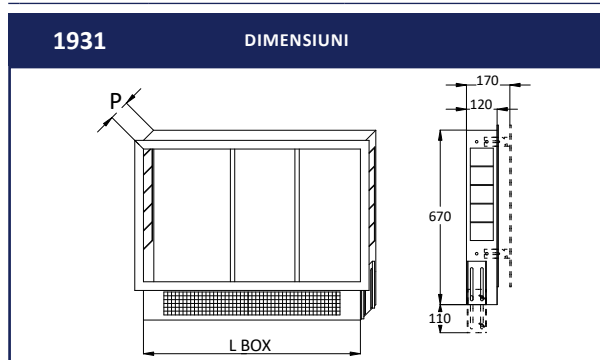

**1939**

Caseta reglabila pe inaltime si in adancime pentru colectoare tip bara si "FLOOR". Necesita seturi de prindere art. 1865-1864 in functie de diametrul colectorului

i Adancime reglabila de la 90 mm la 140 mm

Cod	Dimensiune	Pret €	Ambalare
181 0192	400 x 660 x 90 ÷ 140		1/1
181 0193	500 x 660 x 90 ÷ 140		1/1
181 0206	600 x 660 x 90 ÷ 140		1/1
181 0194	700 x 660 x 90 ÷ 140		1/1
181 0195	1000 x 660 x 90 ÷ 140		1/1

1939

DIMENSIUNI

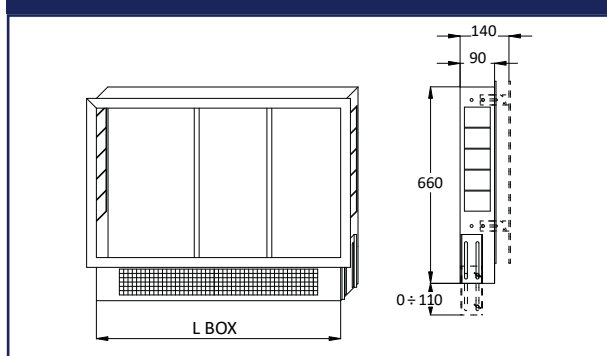
**1940**

Caseta reglabila pe inaltime si in adancime pentru grupuri de amestec si distributie si colectoare.

Necesita seturi de prindere

i Adancime reglabila de la 120 mm la 170 mm

Cod	Dimensiune	Pret €	Ambalare
181 0020	600 x 670 x 120 ÷ 170		1/1
181 0016	700 x 670 x 120 ÷ 170		1/1
181 0015	850 x 670 x 120 ÷ 170		1/1
181 0019	1000 x 670 x 120 ÷ 170		1/1
181 0025	1200 x 670 x 120 ÷ 170		1/1

1940

DIMENSIUNI

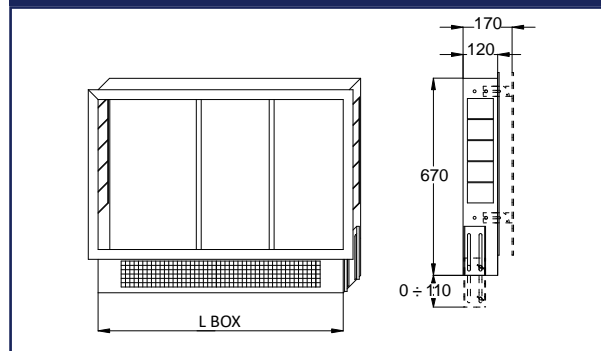
**1941**

Caseta externa pentru colectoare "INDUSTRIAL FLOOR"

Cod	Dimensiune	Pret €	Ambalare
181 0110	900 x 650 x 170		1/1
181 0111	1200 x 650 x 170		1/1

1941

DIMENSIUNI

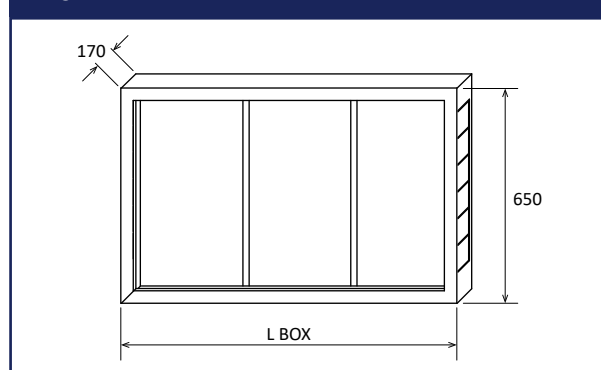

**1807**

Seturi de prindere pentru colectoare "RUBINO", "NINO", "MAXIMA CORNER", "MAXIMA VERTI", "LINEARE" si "MAXIMA" pentru casetele art. 1810-1920-1930

Cod	Dimensiune	Pret €	Ambalare
181 0022	3/4" - 1"		1/10

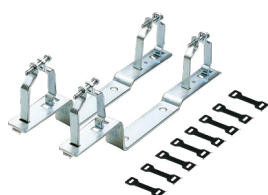
**1865**

Seturi de prindere pentru colectoare bara de 3/4" - 1" - 1"1/4 pentru caseta art. 1940 si "INDUSTRIAL FLOOR" pentru caseta art. 1941

Cod	Dimensiune	Pret €	Ambalare
181 0007	3/4" - 1" - 1"1/4 - 1"1/2		1/25

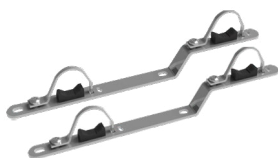
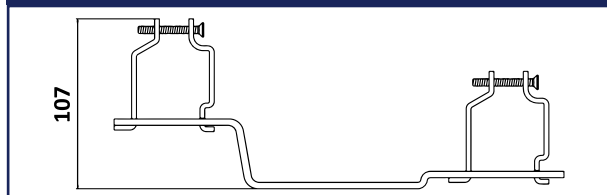
1865 DIMENSIUNI**1870**

Kit fixare colectoare "MAXIMA", "MAXIMA CORNER", "NINO", "RUBINO" si "MAXIMA VERTI"

Cod	Dimensiune	Pret €	Ambalare
181 0109	3/4"		1/25
181 0108	1"		1/25

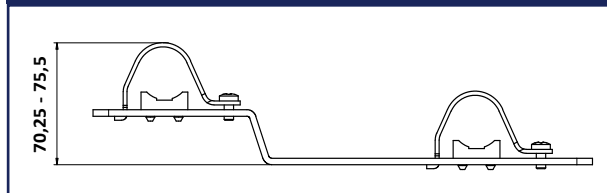
1870 DIMENSIUNI**1877SKIT**

Kit de fixare a colectoarelor "MAXIMA", "MAXIMA CORNER", "MAXIMA VERTI", "NINO" si "RUBINO"

Cod	Dimensiune	Pret €	Ambalare
181 0100	3/4"		1/5
181 0101	1"		1/5

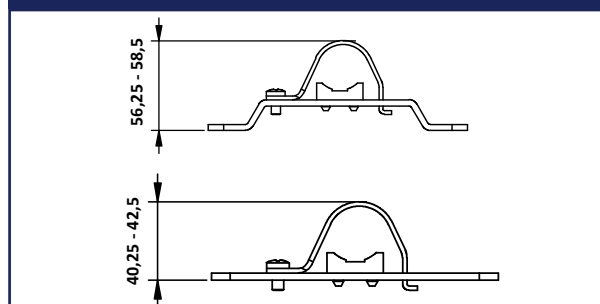
1877SKIT DIMENSIUNI**3049SKIT**

Kit de fixare a colectoarelor "FLOOR"

Cod	Dimensiune	Pret €	Ambalare
385 0063	1"		1/5

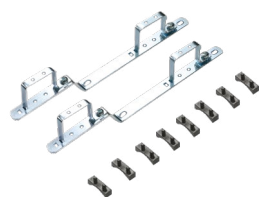
**1863**

Set de prindere pentru colectoare "FLOOR" pentru caseta Art. 1931-1939-1940

Cod	Dimensiune	Pret €	Ambalare
181 0032	1"		1/25
181 0203	1"1/4		1/25

Compatibil si cu colectoare LINEARE

**1812VIT**

Pereche de suruburi pentru caseta universala art. 1812

Cod	Dimensiune	Pret €	Ambalare
181 0155	-		10/200



**2139**

Robinet cu sfera motorizat, cu trecere totala, cu 2 cai F/F, pentru actuator cu baza ISO5211

Cod	Dimensiune	Pret €	Ambalare
213 0104	1/2"		15/60
213 0107	3/4"		10/40
213 0108	1"		7/28

**2138**

Robinet cu sfera, motorizat cu 2 iesiri M/F

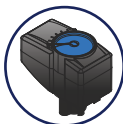

i Disponibil si cu alimentare 24 Vac

Cod	Dimensiune	Aliment.	Pret €	Ambalare
213 0020	1/2"	230 Vac		1/14
213 0003	3/4"	230 Vac		1/14
213 0007	1"	230 Vac		1/14
213 0019	1"1/4	230 Vac		1/14

**2133**

Robinet cu sfera, motorizat cu 2 iesiri M/M

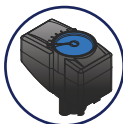

i Disponibil si cu alimentare 24 Vac

Cod	Dimensiune	Aliment.	Pret €	Ambalare
213 0011	3/4"	230 Vac		1/14
213 0016	1"	230 Vac		1/14

**9535**

Servomotor pentru robinet cu 2 cai (art. 2138-2133); rotatie monodirectionala cu unghi de 90° dotat cu siguranta de protectie. Carcasa cu grad de protectie IP54

Cod	Tensiune	Timp manevra	Pret €	Ambalare
213 0024	230 Vac	30 sec		1/8
213 0072	24 Vac	30 sec		1/8

**2134**

Robinet cu sfera, motorizat cu 3 cai deviator, cu 3 intrari

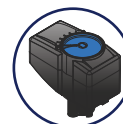

i Disponibil si cu alimentare 24 Vac

Cod	Dimensiune	Aliment.	Pret €	Ambalare
213 0009	3/4"	230 Vac		1/4
213 0018	1"	230 Vac		1/4

Până la terminarea stocului

**9537**

Servomotor pentru robinet deviator (art.2134); rotatie monodirectionala cu unghi de 180° dotat cu siguranta de protectie. Carcasa cu grad de protectie IP54

Cod	Tensiune	Timp manevra	Pret €	Ambalare
213 0025	230 Vac	60 sec		1/8
213 0031	24 Vac	60 sec		1/8

Până la terminarea stocului

NOU TATI

**2135**

Robinet cu sfera, motorizat cu 3 cai deviator, cu 3 intrari

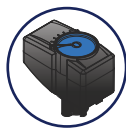

i Disponibil si cu alimentare 24 Vac

i Ideal pentru pompe de căldură

Cod	Dimensiune	Aliment.	Pret €	Ambalare
213 0166	3/4"	230 Vac		1/4
213 0167	1"	230 Vac		1/4
213 0168	1"1/4	230 Vac		1/4

**9536**

Servomotor pentru robinet de zona cu by-pass (art. 2136-2137) si pentru robinet deviator (art. 2135); rotatie bidirectionala cu unghi de 90° dotat cu siguranta de protectie. Carcasa cu grad de protectie IP54

Cod	Tensiune	Timp manevra	Pret €	Ambalare
213 0030	230 Vac	30 sec		1/8
213 0037	24 Vac	30 sec		1/8

NOU TATI

**2135ISOL**

Izolatie pentru robinet de zona cu by-pass (art. 2136) si pentru robinet deviator (art. 2135)

Cod	Dimensiune	Pret €	Ambalare
556 0466	3/4"		1/5
556 0467	1"-1"1/4		1/5

**2137**

Robinet cu sfera, motorizat cu 3 cai cu by-pass, cu 3 intrari

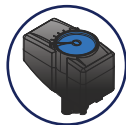

i Disponibil si cu alimentare 24 Vac

Cod	Dimensiune	Aliment.	Pret €	Ambalare
213 0021	3/4"	230 Vac		1/4
213 0015	1"	230 Vac		1/4

**2136**

Robinet cu sfera, motorizat cu 3 cai cu by-pass, cu 4 intrari, distanta variabila intre axe (50-63 mm pentru robinet de 3/4" - 55-63 mm pentru robinet de 1")

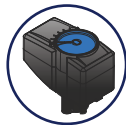

i Disponibil si cu alimentare 24 Vac

Cod	Dimensiune	Aliment.	Pret €	Ambalare
213 0013	3/4"	230 Vac		1/4
213 0028	1"	230 Vac		1/4



2138 - 2133

CARACTERISTICI TEHNICE

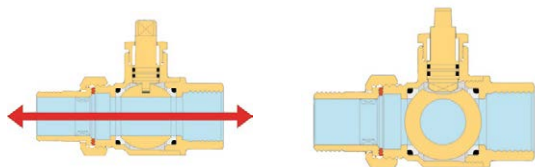

- Alimentare 230 Vac sau 24 Vac
- Contact releu 6A 250 Vac
- Grad de protectie IP 54
- Cuplu maxim de rotatie 10 Nm
- Timp rotație 30 sec.
- Siguranta 5x20 F350 mA

2135

CARACTERISTICI TEHNICE

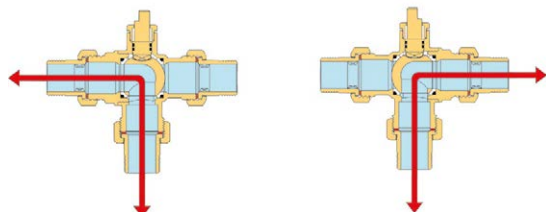

- Alimentare 230 Vac sau 24 Vac
- Contact releu 6A 250 Vac
- Grad de protectie IP 54
- Cuplu maxim de rotatie 10 Nm
- Timp rotație 30 sec.
- Siguranta 5x20 F350 mA.

2137

CARACTERISTICI TEHNICE

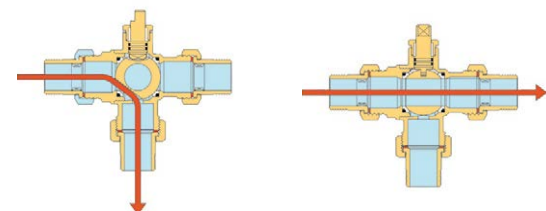

- Alimentare 230 Vac sau 24 Vac
- Contact releu 6A 250 Vac
- Grad de protectie IP 54
- Cuplu maxim de rotatie 10 Nm
- Timp rotație 30 sec.
- Siguranta 5x20 F350 mA

2136

CARACTERISTICI TEHNICE

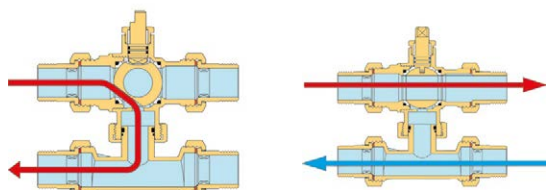

- Alimentare 230 Vac sau 24 Vac
- Contact releu 6A 250 Vac
- Grad de protectie IP 54
- Cuplu maxim de rotatie 10 Nm
- Timp rotație 30 sec.
- Siguranta 5x20 F350 mA

EXEMPLU DE INSTALARE

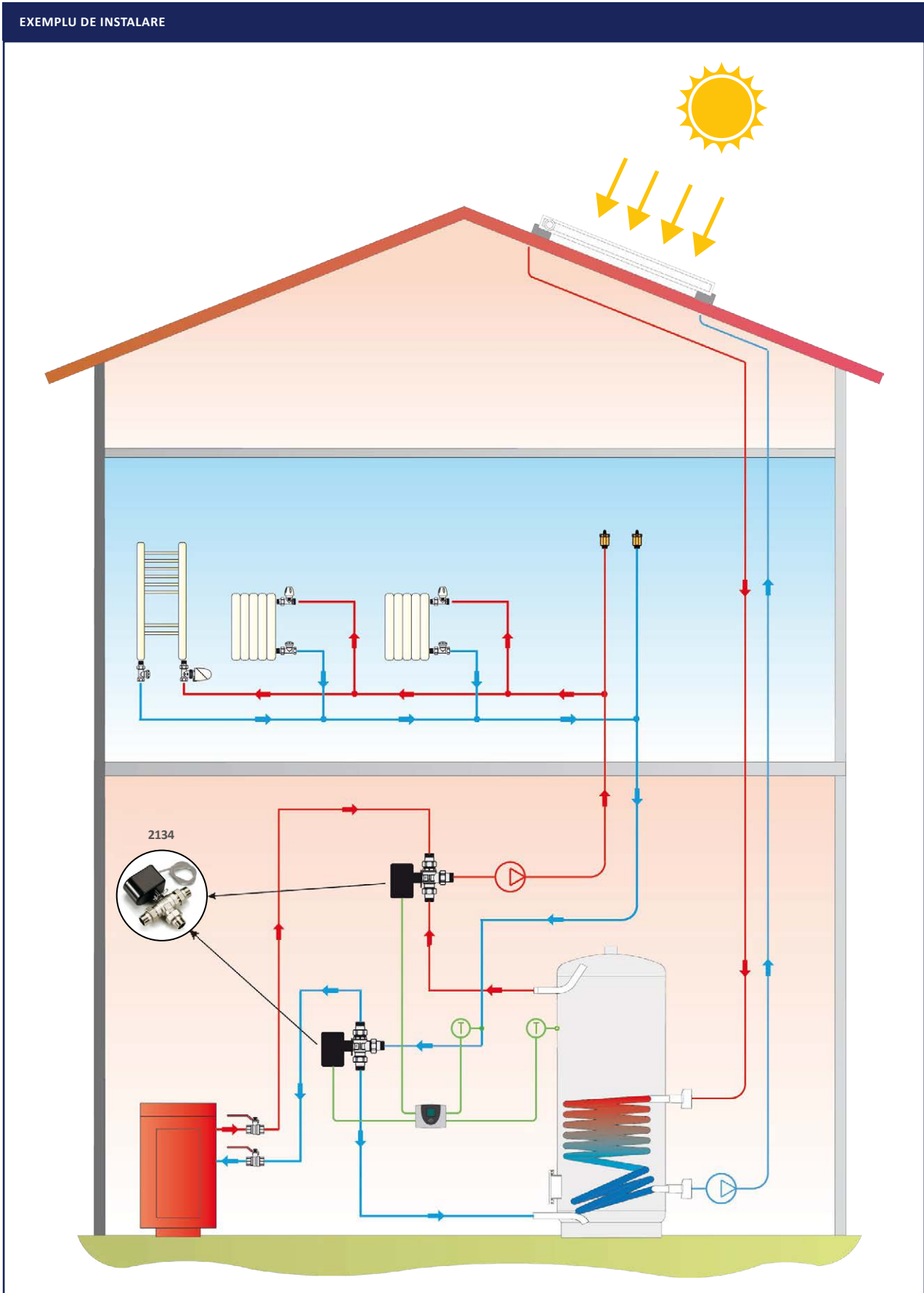

11 ROBINETI CU SFERA, MOTORIZATI

EXEMPLU DE INSTALARE

Imaginea de mai jos reprezinta o instalatie echipata cu robineti motorizati cu 3 cai si by-pass. Robinetii motorizati cu 3 cai au rolul de a intrerupe admisia cu agent termic catre incaperile unde temperatura setata a fost atinsa, by-pass-ul deviator asigurand totodata un debit constant pentru pompa de circulatie.

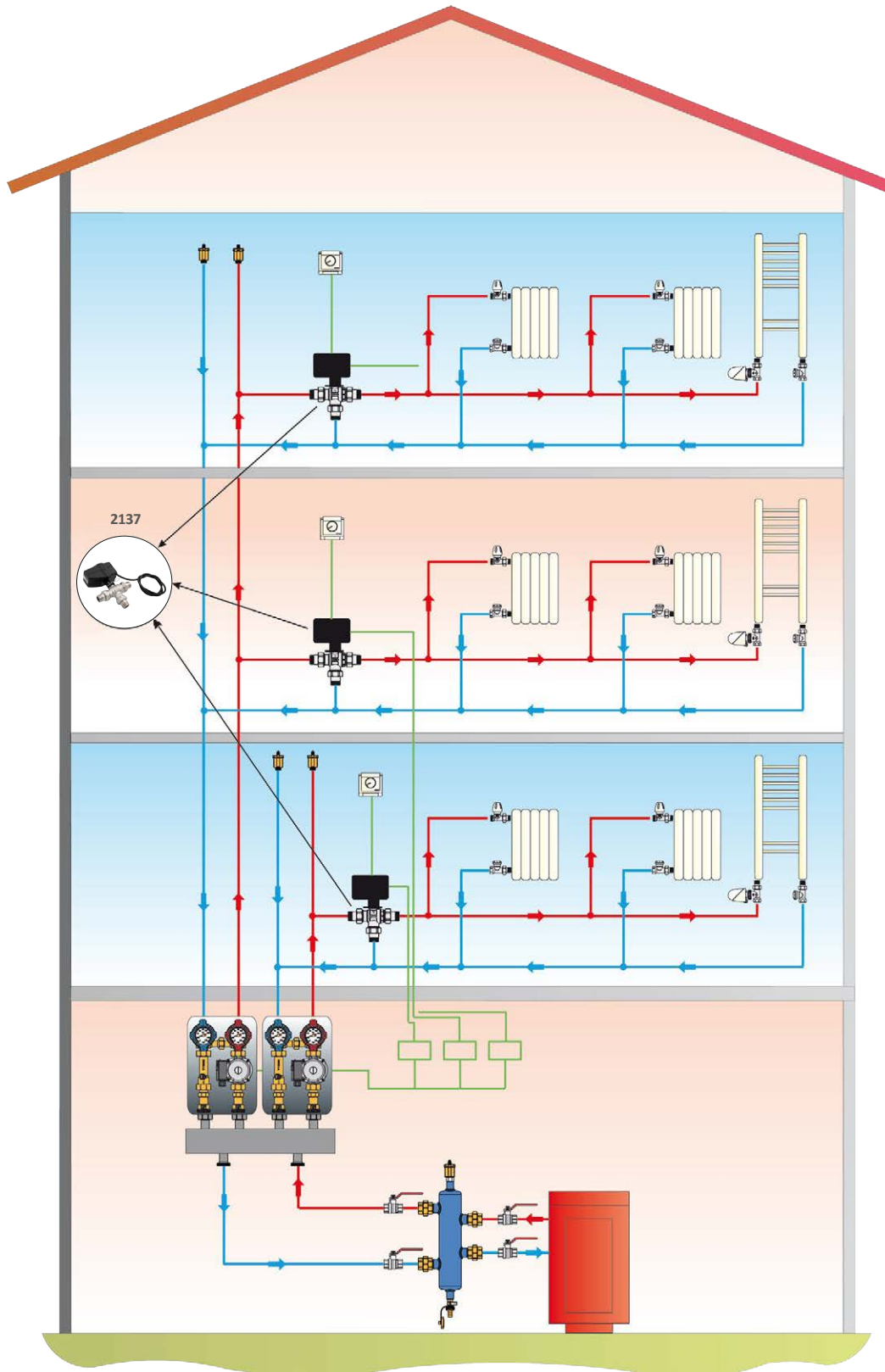

Adaptor pentru conexiuni 1/2" (Ø16)

**1233**

Pentru tub din CUPRU

Piulita si inel in P.T.F.E. pentru conexiuni 1/2"x16

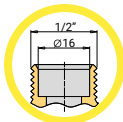

Cod	Dimensiune	Pret €	Ambalare
120 0113	16/10 - 1/2" (Ø16)		50/500
120 0007	16/12 - 1/2" (Ø16)		50/400
120 0042	16/14 - 1/2" (Ø16)		50/500
120 0274	16/15 - 1/2" (Ø16)		50/500

**1233N**

Pentru tub din CUPRU

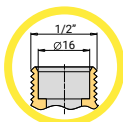
Piulita si inel in P.T.F.E. pentru conexiuni 1/2"x16
Versiunea nichelata

Cod	Dimensiune	Pret €	Ambalare
120 0130	16/10 - 1/2" (Ø16)		50/500
120 0068	16/12 - 1/2" (Ø16)		50/400
120 0108	16/14 - 1/2" (Ø16)		50/500
120 0273	16/15 - 1/2" (Ø16)		50/500

**1235**

Pentru tub din CUPRU

Piulita si inel in P.T.F.E. pentru conexiuni 1/2"x16

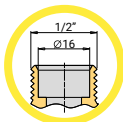

Cod	Dimensiune	Pret €	Ambalare
120 0093	16 - 1/2" (Ø16)		50/600

**1235N**

Pentru tub din CUPRU

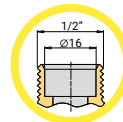
Piulita si inel in P.T.F.E. pentru conexiuni 1/2"x16
Versiunea nichelata

Cod	Dimensiune	Pret €	Ambalare
120 0105	16 - 1/2" (Ø16)		50/600

**1240N**

Pentru tub din CUPRU

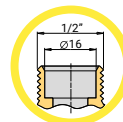
Piulita si inel de compresie pentru conexiuni 1/2"x16
Versiunea nichelata

Cod	Dimensiune	Pret €	Ambalare
144 0028	10 - 1/2" (Ø16)		10/400
144 0005	12 - 1/2" (Ø16)		10/400
144 0013	14 - 1/2" (Ø16)		10/400
144 0016	15 - 1/2" (Ø16)		10/400
144 0025	16 - 1/2" (Ø16)		10/400

**1240K**

Pentru tub din CUPRU

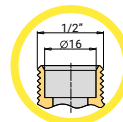
Piulita si inel de compresie pentru conexiuni 1/2"x16
Versiunea cromata

Cod	Dimensiune	Pret €	Ambalare
144 0126	10 - 1/2" (Ø16)		10/400
144 0116	12 - 1/2" (Ø16)		10/400
144 0127	14 - 1/2" (Ø16)		10/400
144 0112	15 - 1/2" (Ø16)		10/400
144 0128	16 - 1/2" (Ø16)		10/400

Adaptor pentru conexiuni 1/2" (Ø16)

**1435**

Pentru tub PEX

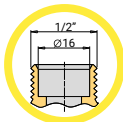
Adaptor pentru conexiuni
1/2"x16

Cod	Dimensiune	Pret €	Ambalare
144 0039	12 x 1,1 - 1/2" (Ø16)		10/350
144 0029	12 x 2,0 - 1/2" (Ø16)		10/350
144 0102	14 x 2,0 - 1/2" (Ø16)		10/350
144 0026	15 x 2,5 - 1/2" (Ø16)		10/350
144 0049	16 x 1,5 - 1/2" (Ø16)		10/350
144 0263	16 x 1,8 - 1/2" (Ø16)		10/300
144 0009	16 x 2,0 - 1/2" (Ø16)		10/300
144 0006	16 x 2,2 - 1/2" (Ø16)		10/300

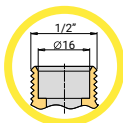
**1435N**Adaptor pentru conexiuni
1/2"x16. Pentru tub PEX

Cod	Dimensiune	Pret €	Ambalare
144 0113	12 x 1,1 - 1/2" (Ø16)		10/350
144 0058	12 x 2,0 - 1/2" (Ø16)		10/350
144 0068	14 x 2,0 - 1/2" (Ø16)		10/350
144 0007	15 x 2,5 - 1/2" (Ø16)		10/350
144 0098	16 x 1,5 - 1/2" (Ø16)		10/350
144 0264	16 x 1,8 - 1/2" (Ø16)		10/300
144 0004	16 x 2,0 - 1/2" (Ø16)		10/300
144 0037	16 x 2,2 - 1/2" (Ø16)		10/300

Până la terminarea stocului

**1435K**

Pentru tub PEX

Adaptor pentru conexiuni
1/2"x16

Versiunea cromata

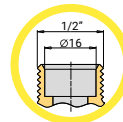

Cod	Dimensiune	Pret €	Ambalare
144 0141	12 x 1,1 - 1/2" (Ø16)		10/350
144 0142	12 x 2,0 - 1/2" (Ø16)		10/350
144 0143	14 x 2,0 - 1/2" (Ø16)		10/350
144 0144	15 x 2,5 - 1/2" (Ø16)		10/350
144 0145	16 x 1,5 - 1/2" (Ø16)		10/350
144 0022	16 x 2,0 - 1/2" (Ø16)		10/300
144 0146	16 x 2,2 - 1/2" (Ø16)		10/300

**1635**

Pentru tub MULTISTRAT

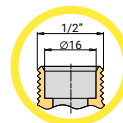
Adaptor pentru conexiuni
1/2"x16

Cod	Dimensiune	Pret €	Ambalare
144 0088	14 x 2,0 - 1/2" (Ø16)		10/350
144 0053	16 x 2,0 - 1/2" (Ø16)		10/300
144 0092	16 x 2,25 - 1/2" (Ø16)		10/300

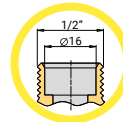
**1635N**Adaptor pentru conexiuni
1/2"x16. Pentru tub MULTISTRAT

Cod	Dimensiune	Pret €	Ambalare
144 0010	14 x 2,0 - 1/2" (Ø16)		10/350
144 0001	16 x 2,0 - 1/2" (Ø16)		10/300
144 0021	16 x 2,25 - 1/2" (Ø16)		10/300

Adaptor pentru conexiuni 1/2" (Ø16)

**1635K**

Pentru tub MULTISTRAT

Adaptor pentru conexiuni
1/2"x16

Versiunea cromata

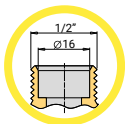

Cod	Dimensiune	Pret €	Ambalare
144 0114	14 x 2,0 - 1/2" (Ø16)		10/350
144 0041	16 x 2,0 - 1/2" (Ø16)		10/300
144 0170	16 x 2,25 - 1/2" (Ø16)		10/300

**1716**

Pentru tub PEX

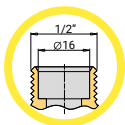
Racord drept cu piulita pentru
conexiuni 1/2"x16

Cod	Dimensiune	Pret €	Ambalare
170 0103	16 x 1,8 - 1/2" (Ø16)		10/100
170 0082	16 x 2,0 - 1/2" (Ø16)		10/100
170 0093	20 x 1,9 e 2,0 - 1/2" (Ø16)		10/100

**1668**

Pentru tub MULTISTRAT

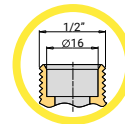
Racord drept cu piulita pentru
conexiuni 1/2"x16

Cod	Dimensiune	Pret €	Ambalare
165 0028	16 x 2,0 - 1/2" (Ø16)		10/100
165 0077	20 x 2,0 - 1/2" (Ø16)		10/100

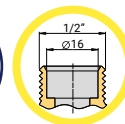
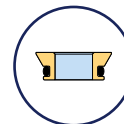
**1859A16**Adaptor pentru a transforma un
filet 1/2"x16 in filet cu fata plana

Cod	Dimensiune	Pret €	Ambalare
144 0311	1/2" (Ø16)		10/400

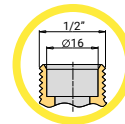
**1879**Racord terminal cu 1/2"x16-
3/4"x18 Eurocono conexiuni

Cod	Dimensiune	Pret €	Ambalare
144 0063	1/2" (Ø16)		10/300

**1665**

Racord drept cu piulita si garnitura plata

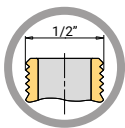

i Disponibil si in varianta staniu

Cod	Dimensiune	Pret €	Ambalare
165 0034	16 x 1/2"		10/100
165 0061	20 x 1/2"		10/100

**1715**

Racord drept cu piulita si garnitura plata

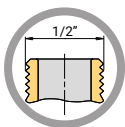

Cod	Dimensiune	Grosime	Pret €	Ambalare
170 0135	16 x 1/2"	1,5		10/100
170 0085	16 x 1/2"	1,8		10/100
170 0110	16 x 1/2"	2,0		10/100
170 0032	20 x 1/2"	1,9 și 2,0		10/100

La cerere

Adaptor pentru conexiuni 3/4" (Ø18) (EUROCONO)

**1241N**

Pentru tub din CUPRU

Piulita si inel de compresie pentru conexiuni 3/4"x18 (EUROCONO)

Versiunea nichelata

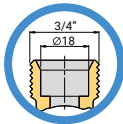

Cod	Dimensiune	Pret €	Ambalare
144 0072	10 - 3/4" (Ø18)		10/250
144 0030	12 - 3/4" (Ø18)		10/250
144 0034	14 - 3/4" (Ø18)		10/250
144 0008	15 - 3/4" (Ø18)		10/250
144 0027	16 - 3/4" (Ø18)		10/250
144 0018	18 - 3/4" (Ø18)		10/250

Până la terminarea stocului

**1241K**

Pentru tub din CUPRU

Piulita si inel de compresie pentru conexiuni 3/4"x18 (EUROCONO)

Versiunea cromata

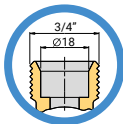

Cod	Dimensiune	Pret €	Ambalare
144 0129	10 - 3/4" (Ø18)		10/250
144 0107	12 - 3/4" (Ø18)		10/250
144 0130	14 - 3/4" (Ø18)		10/250
144 0131	15 - 3/4" (Ø18)		10/250
144 0132	16 - 3/4" (Ø18)		10/250
144 0123	18 - 3/4" (Ø18)		10/250

Până la terminarea stocului

**1436**

Pentru tub PEX

Adaptor pentru conexiuni 3/4"x18 (EUROCONO)

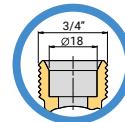

Cod	Dimensiune	Pret €	Ambalare
144 0147	12 x 2,0 - 3/4" (Ø18)		10/250
144 0120	14 x 2,0 - 3/4" (Ø18)		10/250
144 0148	15 x 2,5 - 3/4" (Ø18)		10/250
144 0118	16 x 1,5 - 3/4" (Ø18)		10/250
144 0265	16 x 1,8 - 3/4" (Ø18)		10/250
144 0099	16 x 2,0 - 3/4" (Ø18)		10/250
144 0149	16 x 2,2 - 3/4" (Ø18)		10/250
144 0085	17 x 2,0 - 3/4" (Ø18)		10/200
144 0121	18 x 2,0 - 3/4" (Ø18)		10/200
144 0150	18 x 2,5 - 3/4" (Ø18)		10/200
144 0089	20 x 2,0 - 3/4" (Ø18)		10/200
144 0151	20 x 2,8 - 3/4" (Ø18)		10/200

**1436N**

Adaptor pentru conexiuni 3/4"x18 (EUROCONO). Pentru tub PEX

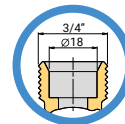

Cod	Dimensiune	Pret €	Ambalare
144 0254	12 x 1,1 - 3/4" (Ø18)		10/250
144 0054	12 x 2,0 - 3/4" (Ø18)		10/250
144 0059	14 x 2,0 - 3/4" (Ø18)		10/250
144 0078	15 x 1,5 - 3/4" (Ø18)		10/250
144 0036	15 x 2,5 - 3/4" (Ø18)		10/250
144 0042	16 x 1,5 - 3/4" (Ø18)		10/250
144 0255	16 x 1,8 - 3/4" (Ø18)		10/250
144 0011	16 x 2,0 - 3/4" (Ø18)		10/250
144 0047	16 x 2,2 - 3/4" (Ø18)		10/250
144 0012	17 x 2,0 - 3/4" (Ø18)		10/200
144 0043	18 x 2,0 - 3/4" (Ø18)		10/200
144 0052	18 x 2,5 - 3/4" (Ø18)		10/200
144 0019	20 x 2,0 - 3/4" (Ø18)		10/200
144 0056	20 x 2,8 - 3/4" (Ø18)		10/200

Adaptor pentru conexiuni 3/4" (Ø18) (EUROCONO)

**1436K**

Pentru tub PEX

Adaptor pentru conexiuni
3/4"x18 (EUROCONO)

Versiunea cromata

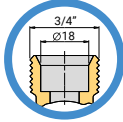

Cod	Dimensiune	Pret €	Ambalare
144 0152	12 x 2,0 - 3/4" (Ø18)		10/250
144 0153	14 x 2,0 - 3/4" (Ø18)		10/250
144 0154	15 x 2,5 - 3/4" (Ø18)		10/250
144 0155	16 x 1,5 - 3/4" (Ø18)		10/250
144 0156	16 x 2,0 - 3/4" (Ø18)		10/250
144 0157	16 x 2,2 - 3/4" (Ø18)		10/250
144 0158	17 x 2,0 - 3/4" (Ø18)		10/200
144 0159	18 x 2,0 - 3/4" (Ø18)		10/200
144 0160	18 x 2,5 - 3/4" (Ø18)		10/200
144 0161	20 x 2,0 - 3/4" (Ø18)		10/200
144 0162	20 x 2,8 - 3/4" (Ø18)		10/200

**1636**

Pentru tub MULTISTRAT

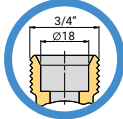
Adaptor pentru conexiuni
3/4"x18 (EUROCONO)

Cod	Dimensiune	Pret €	Ambalare
144 0171	14 x 2,0 - 3/4" (Ø18)		10/250
144 0080	16 x 2,0 - 3/4" (Ø18)		10/250
144 0119	16 x 2,25 - 3/4" (Ø18)		10/250
144 0172	17 x 2,0 - 3/4" (Ø18)		10/200
144 0122	18 x 2,0 - 3/4" (Ø18)		10/200
144 0100	20 x 2,0 - 3/4" (Ø18)		10/200
144 0173	20 x 2,25 - 3/4" (Ø18)		10/200
144 0174	20 x 2,5 - 3/4" (Ø18)		10/200

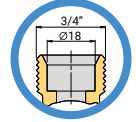
**1636N**Adaptor pentru conexiuni
3/4"x18 (EUROCONO). Pentru
tub MULTISTRAT

Cod	Dimensiune	Pret €	Ambalare
144 0045	14 x 2,0 - 3/4" (Ø18)		10/250
144 0002	16 x 2,0 - 3/4" (Ø18)		10/250
144 0055	16 x 2,25 - 3/4" (Ø18)		10/250
144 0231	16,2 x 2,6 - 3/4" (Ø18)		10/250
144 0033	17 x 2,0 - 3/4" (Ø18)		10/200
144 0014	18 x 2,0 - 3/4" (Ø18)		10/200
144 0003	20 x 2,0 - 3/4" (Ø18)		10/200
144 0023	20 x 2,25 - 3/4" (Ø18)		10/200
144 0038	20 x 2,5 - 3/4" (Ø18)		10/200

**1636K**

Pentru tub MULTISTRAT

Adaptor pentru conexiuni
3/4"x18 (EUROCONO)

Versiunea cromata

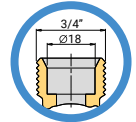

Cod	Dimensiune	Pret €	Ambalare
144 0175	14 x 2,0 - 3/4" (Ø18)		10/250
144 0110	16 x 2,0 - 3/4" (Ø18)		10/250
144 0176	16 x 2,25 - 3/4" (Ø18)		10/250
144 0177	17 x 2,0 - 3/4" (Ø18)		10/200
144 0178	18 x 2,0 - 3/4" (Ø18)		10/200
144 0109	20 x 2,0 - 3/4" (Ø18)		10/200
144 0179	20 x 2,25 - 3/4" (Ø18)		10/200
144 0180	20 x 2,5 - 3/4" (Ø18)		10/200

Adaptor pentru conexiuni 3/4" (Ø18) (EUROCONO)

**1716**

Pentru tub PEX

Racord drept cu piulita pentru conexiuni 3/4"x18 (EUROCONO)

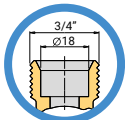

Cod	Dimensiune	Pret €	Ambalare
170 0137	16 x 1,5 - 3/4" (Ø18)		10/100
170 0090	16 x 1,8 - 3/4" (Ø18)		10/100
170 0086	16 x 2,0 - 3/4" (Ø18)		10/100
170 0352	17 x 2,0 - 3/4" (Ø18)		10/100
170 0089	20 x 1,9 e 2,0 - 3/4" (Ø18)		10/100
170 0081	25 x 2,3 - 3/4" (Ø18)		2/100

**1666**

Pentru tub MULTISTRAT

Racord drept cu piulita pentru conexiuni 3/4"x18 (EUROCONO)

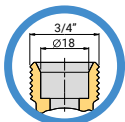

Cod	Dimensiune	Pret €	Ambalare
165 0076	16 x 2,0 - 3/4" (Ø18)		10/100
165 0110	20 x 2,0 - 3/4" (Ø18)		10/100

**1859**

Adaptor pentru a transforma un filet 3/4"x 18 (EUROCONO) in filet cu fata plana

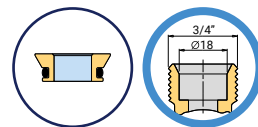

Cod	Dimensiune	Pret €	Ambalare
144 0104	3/4" (Ø18)		10/400

**1879**

Racord terminal

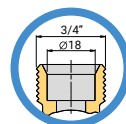

Cod	Dimensiune	Pret €	Ambalare
144 0071	3/4" (Ø18)		10/250

Adaptor pentru conexiuni 24 x 19 fil (ø18)

**1243K**

Pentru tub din CUPRU

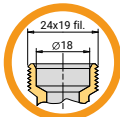
Piulita si inel de compresie pentru conexiuni 24x19 fil (ø 18)
Versiunea cromata

Cod	Dimensiune	Pret €	Ambalare
144 0115	10 - 24 x 19 fil (ø18)		10/250
144 0133	12 - 24 x 19 fil (ø18)		10/250
144 0117	14 - 24 x 19 fil (ø18)		10/250
144 0024	15 - 24 x 19 fil (ø18)		10/250
144 0032	16 - 24 x 19 fil (ø18)		10/250
144 0064	18 - 24 x 19 fil (ø18)		10/250

**1433K**

Pentru tub PEX

Adaptor pentru conexiuni 24x19 fil (ø 18)

Versiunea cromata

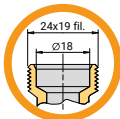

Disponibila la cerere versiunea galbena

Cod	Dimensiune	Pret €	Ambalare
144 0057	15 x 2,5 - 24 x 19 fil (ø18)		10/250
144 0262	16 x 1,5 - 24 x 19 fil (ø18)		10/250
144 0251	16 x 1,8 - 24 x 19 fil (ø18)		10/250
144 0015	16 x 2,0 - 24 x 19 fil (ø18)		10/250
144 0090	16 x 2,2 - 24 x 19 fil (ø18)		10/250
144 0250	17 x 2,0 - 24 x 19 fil (ø18)		10/250
144 0031	18 x 2,0 - 24 x 19 fil (ø18)		10/250
144 0044	18 x 2,5 - 24 x 19 fil (ø18)		10/250
144 0140	20 x 2,0 - 24 x 19 fil (ø18)		10/250

**1633K**

Pentru tub MULTISTRAT

Adaptor pentru conexiuni 24x19 fil (ø 18)

Versiunea cromata

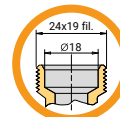

Cod	Dimensiune	Pret €	Ambalare
144 0228	14 x 2,0 - 24 x 19 fil (ø18)		10/250
144 0017	16 x 2,0 - 24 x 19 fil (ø18)		10/250
144 0235	16 x 2,25 - 24 x 19 fil (ø18)		10/250
144 0230	16,2 x 2,6 - 24 x 19 fil (ø18)		10/250
144 0048	18 x 2,0 - 24 x 19 fil (ø18)		10/250
144 0077	20 x 2,0 - 24 x 19 fil (ø18)		10/250
144 0266	20 x 2,25 - 24 x 19 fil (ø18)		10/250
144 0236	20 x 2,5 - 24 x 19 fil (ø18)		10/250

**1716**

Pentru tub PEX

Racord drept cu piulita pentru conexiuni 24x19 fil (ø 18)

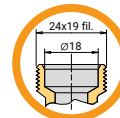

Cod	Dimensiune	Pret €	Ambalare
170 0118	16 x 1,8 - 24 x 19 fil (ø18)		10/100
170 0057	16 x 2,0 - 24 x 19 fil (ø18)		10/100
170 0138	18 x 2,0 - 24 x 19 fil (ø18)		10/100
170 0095	20 x 1,9 e 2,0 - 24 x 19 fil (ø18)		10/100

**1716K**

Pentru tub PEX

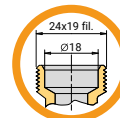
Racord drept cu piulita pentru conexiuni 24x19 fil (ø 18)
Versiunea cromata

Cod	Dimensiune	Pret €	Ambalare
170 0139	16 x 1,8 - 24 x 19 fil (ø18)		10/100
170 0063	16 x 2,0 - 24 x 19 fil (ø18)		10/100
170 0075	18 x 2,0 - 24 x 19 fil (ø18)		10/100
170 0140	20 x 1,9 e 2,0 - 24 x 19 fil (ø18)		10/100

Adaptor pentru conexiuni 24 x 19 fil ($\phi 18$)**1666K**

Pentru tub MULTISTRAT

Racord drept cu piulita pentru conexiuni 24x19 fil ($\phi 18$)

Versiunea cromata

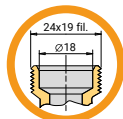

Cod	Dimensiune	Pret €	Ambalare
165 0158	16 x 2,0 - 24 x 19 fil ($\phi 18$)		10/100
165 0198	18 x 2,0 - 24 x 19 fil ($\phi 18$)		10/100
165 0272	20 x 2,0 - 24 x 19 fil ($\phi 18$)		10/100

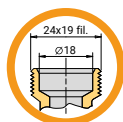
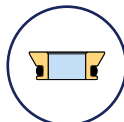
**1859**Adaptor pentru a transforma un filet 24x19 fil ($\phi 18$) in filet cu fata plana

Cod	Dimensiune	Pret €	Ambalare
144 0104	24 x 19 fil ($\phi 18$)		10/400

**1879K**

Racord terminal

Versiunea cromata

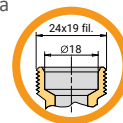

Cod	Dimensiune	Pret €	Ambalare
144 0211	24 x 19 fil ($\phi 18$)		1/250



ADAPTORI PENTRU TUB DE CUPRU - REF. - 1240 - 1241 - 1243

NUMARUL DE ROTATII PENTRU PIULITA					
Ø 10 - 1/2" (Ø16) 1-1/4=10 Nm	Ø 12 - 1/2" (Ø16) 1-1/4=10 Nm	Ø 14 - 1/2" (Ø16) 1-1/4=10 Nm	Ø 15 - 1/2" (Ø16) 1-1/4=12 Nm	Ø 16 - 1/2" (Ø16) 1-1/4=12 Nm	Ø 10 - 3/4" (Ø18) 1-1/4=9 Nm
Ø 12 - 3/4" (Ø18) 1-1/4=9 Nm	Ø 14 - 3/4" (Ø18) 1-1/4=9 Nm	Ø 15 - 3/4" (Ø18) 1-1/4=9 Nm	Ø 16 - 3/4" (Ø18) 1-1/4=12 Nm	Ø 18 - 3/4" (Ø18) 1-1/4=15 Nm	Ø 18 - 3/4" (Ø18) 1-1/4=15 Nm
Ø 10 - 24x19 fil (Ø18) 1-1/4=9 Nm	Ø 12 - 24x19 fil (Ø18) 1-1/4=9 Nm	Ø 14 - 24x19 fil (Ø18) 1-1/4=9 Nm	Ø 15 - 24x19 fil (Ø18) 1-1/4=25 Nm	Ø 18 - 24x19 fil (Ø18) 1-1/4=15 Nm	

DACA ESTE NECESAR SE MAI POT APLICA PANA LA 1/4-1/2 ROTATII ULTERIOARE

ADAPTORI PENTRU TUBURI PEX - REF. - 1433 - 1435 - 1436



















NUMARUL DE ROTATII PENTRU PIULITA					
12x1,1 - 1/2" (Ø16) 1=25 Nm	12x2,0 - 1/2" (Ø16) 1=28 Nm	14x2,0 - 1/2" (Ø16) 1=28 Nm	15x2,5 - 1/2" (Ø16) 1=28 Nm	16x1,5 - 1/2" (Ø16) 1=28 Nm	16x1,8 - 1/2" (Ø16) 1=28 Nm
16x2,0 - 1/2" (Ø16) 1=29 Nm	16x2,2 - 1/2" (Ø16) 1=29 Nm	12x1,1 - 3/4" (Ø18) 1=23 Nm	12x2,0 - 3/4" (Ø18) 1=30 Nm	14x2,0 - 3/4" (Ø18) 1=30 Nm	15x1,5 - 3/4" (Ø18) 1=30 Nm
15x2,5 - 3/4" (Ø18) 1=30 Nm	16x1,5 - 3/4" (Ø18) 1=31 Nm	16x2,0 - 3/4" (Ø18) 1=32 Nm	16x2,2 - 3/4" (Ø18) 1=32 Nm	17x2,0 - 3/4" (Ø18) 1=40 Nm	18x2,0 - 3/4" (Ø18) 1=40 Nm
18x2,5 - 3/4" (Ø18) 1=40 Nm	20x2,0 - 3/4" (Ø18) 1=44 Nm	15x2,5 - 24x19 fil (Ø18) 1=30 Nm	16x1,5 - 24x19 fil (Ø18) 1=30 Nm	16x2,0 - 24x19 fil (Ø18) 1=32 Nm	16x2,2 - 24x19 fil (Ø18) 1=32 Nm
17x2,0 - 24x19 fil (Ø18) 1=40 Nm	18x2,0 - 24x19 fil (Ø18) 1=40 Nm	18x2,5 - 24x19 fil (Ø18) 1=40 Nm	20x2,0 - 24x19 fil (Ø18) 1=44 Nm		

ADAPTORI PENTRU TUBURI MULTISTRAT AL-COBRAPEX - REF. - 1633 - 1635 - 1636 - 1636N06

NUMARUL DE ROTATII PENTRU PIULITA					
14x2,0 - 1/2" (Ø16) 1=28 Nm	16x2,0 - 1/2" (Ø16) 1=30 Nm	16x2,25 - 1/2" (Ø16) 1=30 Nm	14x2,0 - 3/4" (Ø18) 1=30 Nm	16x2,0 - 3/4" (Ø18) 1=33 Nm	16x2,25 - 3/4" (Ø18) 1=33 Nm
17x2,0 - 3/4" (Ø18) 1=40 Nm	18x2,0 - 3/4" (Ø18) 1=40 Nm	20x2,0 - 3/4" (Ø18) 1=45 Nm	20x2,25 - 3/4" (Ø18) 1=45 Nm	20x2,5 - 3/4" (Ø18) 1=45 Nm	14x2,0 - 24x19 fil (Ø18) 1=30 Nm
16x2,0 - 24x19 fil (Ø18) 1=33 Nm	18x2,0 - 24x19 fil (Ø18) 1=40 Nm	20x2,0 - 24x19 fil (Ø18) 1=45 Nm	16x2,0 - 1" (Ø24) 1=35 Nm	20x2,0 - 1" (Ø24) 1=48 Nm	26x3,0 - 1" (Ø24) 1=53 Nm

12 ROBINETI PENTRU RADIATOARE



Robineți termostatzabili cu pre-reglare nichelați			237
Robineti termostatzabili			240
Robineti de retur			242
Robineti termostatzabili cromati			243
Robineti de retur termostatzabili cromati			244
Capete termostactice			245
Sisteme de termoreglare Wi-Fi	TIEMME GATE >>>		240
Sisteme de termoreglare wireless			247
Kit robineti termostatzabili cu pre-reglare			248
Kit robineti termostatzabili			249
TIEMME BOX			250
Robineti manuali seria "MAXIMA"			251
Robineti manuali seria "NEW EXCEL"			252
Robineti de retur seria "EXCEL"			254
Kit robineti manuali			255
Robineti si distribuitoare			256
Distribuitor bitub			259
Accesorii			260

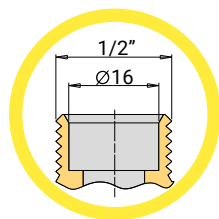

1668 (1/2")
 pentru tub multistrat
 Ø14x2,0
 Ø16x2,0
 Ø18x2,0
 Ø20x2,0

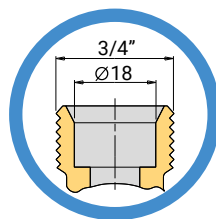
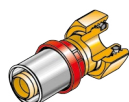

1666
 pentru tub multistrat
 Ø14x2,0
 Ø16x2,0
 Ø18x2,0
 Ø20x2,0

1716
 pentru tub Pex
 Ø16x1,8 Ø16x2,0
 Ø20x1,9 Ø20x2,0
 Ø25x2,3

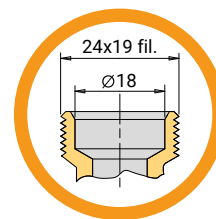
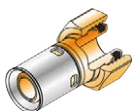

1666K24
 pentru tub multistrat
 Ø16x2,0
 Ø18x2,0
 Ø20x2,0

1716K
 pentru tub Pex
 Ø16x1,8 Ø16x2,0
 Ø20x1,9 Ø20x2,0

1716
 pentru tub Pex
 Ø16x1,8 Ø16x2,0
 Ø20x1,9 Ø20x2,0

1635
 pentru tub multistrat
 Ø14x2,0 Ø16x2,0
 Ø16x2,25

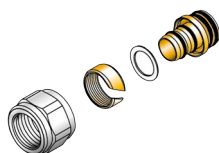

1636
 pentru tub multistrat
 Ø14x2,0 Ø16x2,0
 Ø16x2,25 Ø17x2,0
 Ø18x2,0 Ø20x2,0
 Ø20x2,25 Ø20x2,5

1633K
 pentru tub multistrat
 Ø16x2,0 Ø16x2,25
 Ø18x2,0 Ø20x2,0
 Ø20x2,5

1435
 pentru tub Pex
 Ø12x1,1 Ø12x2,0
 Ø14x2,0 Ø15x2,5
 Ø16x1,5 Ø16x2,0
 Ø16x2,2

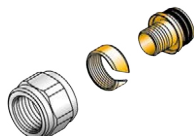

1436
 pentru tub Pex
 Ø12x2,0 Ø14x2,0 Ø15x1,5
 Ø15x2,5 Ø16x1,5 Ø16x2,0
 Ø16x2,2 Ø17x2,0 Ø18x2,0
 Ø18x2,5 Ø20x2,0 Ø20x2,8

1433K
 pentru tub Pex
 Ø15x2,5 Ø16x2,0
 Ø16x2,2 Ø17x2,0
 Ø18x2,0 Ø18x2,5
 Ø20x2,0

1233 - 1235
 pentru tub din cupru
 Ø10 - Ø12 - Ø14 - Ø16

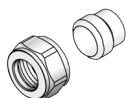

1240
 pentru tub din cupru
 Ø10 - Ø12 - Ø14
 Ø15 - Ø16



1241
 pentru tub din cupru
 Ø10 - Ø12 - Ø14
 Ø15 - Ø16 - Ø18

1243K
 pentru tub din cupru
 Ø15 - Ø16 - Ø18



**331H**

Robinet de colț **TERMOSTATIZABIL CU PRE-REGLARE** cu racord pentru tub din fier. Dotat cu capac de protecție

CU PRE-REGLARE

Cod	Dimensiune	Pret €	Ambalare
331 0006	G 3/8"		10/60
331 0004	G 1/2"		10/60
331 0005	G 3/4"		10/60
Versiunea cu O-ring			
331 0035	G 3/8"		10/60
331 0033	G 1/2"		10/60
331 0034	G 3/4"		10/60

**331G**

Robinet drept **TERMOSTATIZABIL CU PRE-REGLARE** cu racord pentru tub din fier. Dotat cu capac de protecție

CU PRE-REGLARE

Cod	Dimensiune	Pret €	Ambalare
331 0001	G 3/8"		10/60
331 0002	G 1/2"		10/60
331 0003	G 3/4"		10/60
Versiunea cu O-ring			
331 0030	G 3/8"		10/60
331 0031	G 1/2"		10/60
331 0032	G 3/4"		10/60

**332H**

Robinet de colț **TERMOSTATIZABIL CU PRE-REGLARE** cu racord pentru tub din cupru/ PEX/ multistrat. Dotat cu capac de protecție

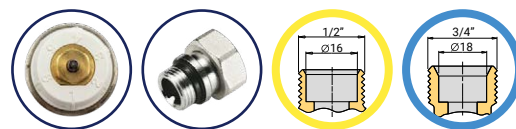
CU PRE-REGLARE

Cod	Dimensiune	Iesiri	Pret €	Ambalare
331 0014	G 3/8"	1/2" (ø16)		10/60
331 0015	G 1/2"	1/2" (ø16)		10/60
331 0016	G 3/8"	3/4" (ø18)		10/60
331 0017	G 1/2"	3/4" (ø18)		10/60
Versiunea cu O-ring				
331 0022	G 3/8"	1/2" (ø16)		10/60
331 0023	G 1/2"	1/2" (ø16)		10/60
331 0024	G 3/8"	3/4" (ø18)		10/60
331 0025	G 1/2"	3/4" (ø18)		10/60

**332G**

Robinet drept **TERMOSTATIZABIL CU PRE-REGLARE** cu racord pentru tub din cupru/ PEX/ multistrat. Dotat cu capac de protecție

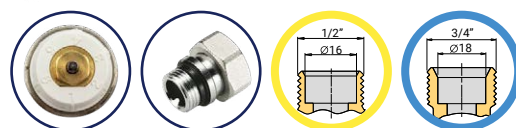
CU PRE-REGLARE

Cod	Dimensiune	Iesiri	Pret €	Ambalare
331 0018	G 3/8"	1/2" (ø16)		10/60
331 0019	G 1/2"	1/2" (ø16)		10/60
331 0020	G 3/8"	3/4" (ø18)		10/60
331 0021	G 1/2"	3/4" (ø18)		10/60
Versiunea cu O-ring				
331 0026	G 3/8"	1/2" (ø16)		10/60
331 0027	G 1/2"	1/2" (ø16)		10/60
331 0028	G 3/8"	3/4" (ø18)		10/60
331 0029	G 1/2"	3/4" (ø18)		10/60

**3313**

Robinet TERMOSTATIZABIL CU PRE-REGLARE prindere reversibila

CU PRE-REGLARE

Cod	Dimensiune	Pret €	Ambalare
331 0009	G 1/2"		10/60
Versiunea cu O-ring			
331 0010	G 1/2"		10/60

**3312**

Robinet TERMOSTATIZABIL CU PRE-REGLARE prindere coaxial stanga pentru conectare pe tub de cupru/ PEX/ multistrat. versiune cu capac de protectie

CU PRE-REGLARE

Cod	Dimensiune	Iesiri	Pret €	Ambalare
331 0007	G 1/2"	3/4"(ϕ 18)		10/60
Versiunea cu O-ring				
331 0008	G 1/2"	3/4"(ϕ 18)		10/60

**3228DX**

Robinet TERMOSTATIZABIL CU PRE-REGLARE prindere coaxial dreapta pentru conectare pe tub de fier.versiune cu capac de protectie

CU PRE-REGLARE

Cod	Dimensiune	Pret €	Ambalare
330 0128	G 3/8"		10/60
330 0123	G 1/2"		10/60
Versiunea cu O-ring			
330 0125	G 1/2"		10/60

**3228SX**

Robinet TERMOSTATIZABIL CU PRE-REGLARE prindere coaxial stanga pentru conectare pe tub de fier.versiune cu capac de protectie

CU PRE-REGLARE

Cod	Dimensiune	Pret €	Ambalare
330 0129	G 3/8"		10/60
330 0124	G 1/2"		10/60
Versiunea cu O-ring			
330 0126	G 1/2"		10/60





3227DX

Robinet TERMOSTATIZABIL CU PRE-REGLARE prindere coaxial dreapta pentru conectare pe tub de cupru/ PEX/ multistrat. versiune cu capac de protecție



+ CU PRE-REGLARE

Cod	Dimensiune	Iesiri	Pret €	Ambalare
330 0119	G 1/2"	3/4"(ϕ 18)		10/60
Versiunea cu O-ring				
330 0121	G 1/2"	3/4"(ϕ 18)		10/60



3227SX

Robinet TERMOSTATIZABIL CU PRE-REGLARE prindere coaxial stanga pentru conectare pe tub de cupru/ PEX/ multistrat. versiune cu capac de protecție



+ CU PRE-REGLARE

Cod	Dimensiune	Iesiri	Pret €	Ambalare
330 0120	G 1/2"	3/4"(ϕ 18)		10/60
Versiunea cu O-ring				
330 0122	G 1/2"	3/4"(ϕ 18)		10/60

INSTRUCȚIUNI PENTRU UN REGLAJ CORECT

1

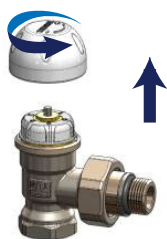

Deșurubați capacul de pe corpul robinetului

2

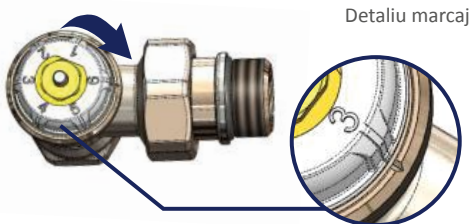

Rotiți butonul numerotat până când numărul corespunzător Kv-ului dorit (vezi tabel) este aliniat cu marcajul de referință de pe corpul robinetului.

TABEL KV

Pozitie		Kv (m ³ /h)
1		0,09
2		0,14
3		0,20
4		0,30
5		0,55
6		0,80

**3306**

Robinet de colt termostaticabil
pentru montare pe tub de fier



Cod	Dimensiune	Pret €	Ambalare
330 0023	G 3/8"		10/60
330 0005	G 1/2"		10/60
330 0022	G 3/4"		10/60
Versiunea cu O-ring			
330 0029	G 3/8"		10/60
330 0026	G 1/2"		10/60
330 0053	G 3/4"		10/60

**3305**

Robinet drept termostaticabil
pentru montare pe tub de fier



Cod	Dimensiune	Pret €	Ambalare
330 0050	G 3/8"		10/60
330 0013	G 1/2"		10/60
330 0015	G 3/4"		10/60
Versiunea cu O-ring			
330 0040	G 3/8"		10/60
330 0035	G 1/2"		10/60
330 0049	G 3/4"		10/60

**3301**

Robinet de colt termostaticabil
pentru conectare pe tub de
cupru/PEX/multistrat.

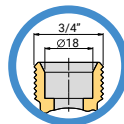
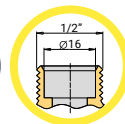

Cod	Dim.	Iesiri	Pret €	Ambalare
330 0017	G 3/8"	1/2" (ø16)		10/60
330 0002	G 1/2"	1/2" (ø16)		10/60
330 0066	G 3/8"	3/4" (ø18)		10/60
330 0046	G 1/2"	3/4" (ø18)		10/60
Versiunea cu O-ring				
330 0011	G 3/8"	1/2" (ø16)		10/60
330 0003	G 1/2"	1/2" (ø16)		10/60
330 0071	G 3/8"	3/4" (ø18)		10/60
330 0051	G 1/2"	3/4" (ø18)		10/60

**3300**

Robinet drept termostaticabil
pentru conectare pe tub de
cupru/PEX/multistrat

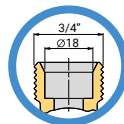
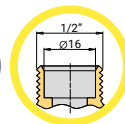

Cod	Dim.	Iesiri	Pret €	Ambalare
330 0058	G 3/8"	1/2" (ø16)		10/60
330 0032	G 1/2"	1/2" (ø16)		10/60
330 0079	G 3/8"	3/4" (ø18)		10/60
330 0065	G 1/2"	3/4" (ø18)		10/60
Versiunea cu O-ring				
330 0048	G 3/8"	1/2" (ø16)		10/60
330 0036	G 1/2"	1/2" (ø16)		10/60
330 0082	G 3/8"	3/4" (ø18)		10/60
330 0083	G 1/2"	3/4" (ø18)		10/60

**3308**

Robinet de colt termostaticabil pentru montare pe tub de fier.
Cu capac de protecție



Cod	Dimensiune	Pret €	Ambalare
330 0031	G 3/8"		10/60
330 0001	G 1/2"		10/60
330 0027	G 3/4"		10/60
Versiunea cu O-ring			
330 0057	G 3/8"		10/60
330 0055	G 1/2"		10/60
330 0075	G 3/4"		10/60

**3307**

Robinet drept termostaticabil pentru montare pe tub de fier.
Cu capac de protecție



Cod	Dimensiune	Pret €	Ambalare
330 0047	G 3/8"		10/60
330 0012	G 1/2"		10/60
330 0007	G 3/4"		10/60
Versiunea cu O-ring			
330 0069	G 3/8"		10/60
330 0074	G 1/2"		10/60
330 0063	G 3/4"		10/60

**3303**

Robinet de colt termostaticabil pentru conectare pe tub de cupru/PEX/multistrat.
Cu capac de protecție

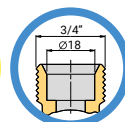
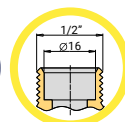

Cod	Dimensiune	Iesiri	Pret €	Ambalare
330 0019	G 3/8"	1/2" (ø16)		10/60
330 0006	G 1/2"	1/2" (ø16)		10/60
330 0067	G 3/8"	3/4" (ø18)		10/60
330 0038	G 1/2"	3/4" (ø18)		10/60
Versiunea cu O-ring				
330 0064	G 3/8"	1/2" (ø16)		10/60
330 0028	G 1/2"	1/2" (ø16)		10/60
330 0088	G 3/8"	3/4" (ø18)		10/60
330 0076	G 1/2"	3/4" (ø18)		10/60

**3302**

Robinet drept termostaticabil pentru conectare pe tub de cupru/PEX/multistrat.
Cu capac de protecție

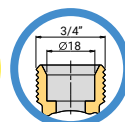
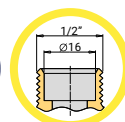

Cod	Dimensiune	Iesiri	Pret €	Ambalare
330 0070	G 3/8"	1/2" (ø16)		10/60
330 0034	G 1/2"	1/2" (ø16)		10/60
330 0080	G 3/8"	3/4" (ø18)		10/60
330 0073	G 1/2"	3/4" (ø18)		10/60
Versiunea cu O-ring				
330 0078	G 3/8"	1/2" (ø16)		10/60
330 0068	G 1/2"	1/2" (ø16)		10/60
330 0087	G 3/8"	3/4" (ø18)		10/60
330 0081	G 1/2"	3/4" (ø18)		10/60



3336
Robinet de retur de colt pentru montare pe tub de fier



Cod	Dimensiune	Pret €	Ambalare
333 0014	G 3/8"		10/60
333 0006	G 1/2"		10/60
333 0011	G 3/4"		10/60
333 0050	G 1/2"		1/60
333 0052	G 3/4"		1/60
Versiunea cu O-ring			
333 0015	G 3/8"		10/60
333 0010	G 1/2"		10/60
333 0017	G 3/4"		10/60
333 0051	G 1/2"		1/60
333 0053	G 3/4"		1/60

versiune cromata



3335
Robinet de retur drept pentru montare pe tub de fier



Cod	Dimensiune	Pret €	Ambalare
333 0027	G 3/8"		10/60
333 0009	G 1/2"		10/60
333 0004	G 3/4"		10/60
333 0046	G 1/2"		1/60
333 0048	G 3/4"		1/60
Versiunea cu O-ring			
333 0024	G 3/8"		10/60
333 0026	G 1/2"		10/60
333 0031	G 3/4"		10/60
333 0047	G 1/2"		1/60
333 0049	G 3/4"		1/60

versiune cromata



3331
Robinet de retur de colt pentru conectare pe tub de cupru/PEX/multistrat

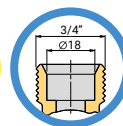
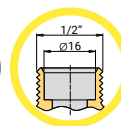

Cod	Dim.	Iesiri	Pret €	Ambalare
333 0007	G 3/8"	1/2" (ø16)		10/60
333 0002	G 1/2"	1/2" (ø16)		10/60
333 0033	G 3/8"	3/4" (ø18)		10/60
333 0013	G 1/2"	3/4" (ø18)		10/60
Versiunea cu O-ring				
333 0008	G 3/8"	1/2" (ø16)		10/60
333 0003	G 1/2"	1/2" (ø16)		10/60
333 0029	G 3/8"	3/4" (ø18)		10/60
333 0025	G 1/2"	3/4" (ø18)		10/60



3330
Robinet de retur drept pentru conectare pe tub de cupru/PEX/multistrat

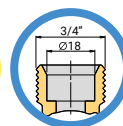
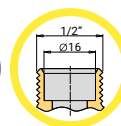

Cod	Dim.	Iesiri	Pret €	Ambalare
333 0032	G 3/8"	1/2" (ø16)		10/60
333 0021	G 1/2"	1/2" (ø16)		10/60
333 0038	G 3/8"	3/4" (ø18)		10/60
333 0019	G 1/2"	3/4" (ø18)		10/60
Versiunea cu O-ring				
333 0030	G 3/8"	1/2" (ø16)		10/60
333 0023	G 1/2"	1/2" (ø16)		10/60
333 0041	G 3/8"	3/4" (ø18)		10/60
333 0028	G 1/2"	3/4" (ø18)		10/60



**3306C**

Robinet de colt termostaticabil
pentru montare pe tub de fier.
versiune cromata lucioasa

Cod	Dimensiune	Pret €	Ambalare
330 0061	G 3/8"		10/60
330 0016	G 1/2"		10/60

**3305C**

Robinet drept termostaticabil
pentru montare pe tub de fier.
versiune cromata lucioasa

Cod	Dimensiune	Pret €	Ambalare
330 0060	G 3/8"		10/60
330 0025	G 1/2"		10/60

**3301C**

Robinet de colt termostaticabil
pentru conectare pe tub de
cupru/PEX/multistrat.
versiune cromata lucioasa

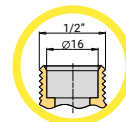

Cod	Dimensiune	Iesiri	Pret €	Ambalare
330 0042	G 3/8"	1/2" (Ø16)		10/60
330 0009	G 1/2"	1/2" (Ø16)		10/60

**3300C**

Robinet drept termostaticabil
pentru conectare pe tub de
cupru/PEX/multistrat.
versiune cromata lucioasa

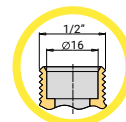

Cod	Dimensiune	Iesiri	Pret €	Ambalare
330 0059	G 3/8"	1/2" (Ø16)		10/60
330 0041	G 1/2"	1/2" (Ø16)		10/60

**3336C**

Robinet de retur de colt pentru montare pe tub de fier.
versiune cromata lucioasa

Cod	Dimensiune	Pret €	Ambalare
333 0035	G 3/8"		10/60
333 0001	G 1/2"		10/60

**3335C**

Robinet de retur drept pentru montare pe tub de fier.
versiune cromata lucioasa

Cod	Dimensiune	Pret €	Ambalare
333 0034	G 3/8"		10/60
333 0012	G 1/2"		10/60

**3331C**

Robinet de retur de colt pentru conectare pe tub de cupru/PEX/multistrat.
versiune cromata lucioasa

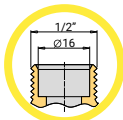

Cod	Dimensiune	lesiri	Pret €	Ambalare
333 0016	G 3/8"	1/2"(ø16)		10/60
333 0005	G 1/2"	1/2"(ø16)		10/60

**3330C**

Robinet de retur drept pentru conectare pe tub de cupru/PEX/multistrat.
versiune cromata lucioasa

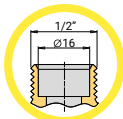

Cod	Dimensiune	lesiri	Pret €	Ambalare
333 0036	G 3/8"	1/2"(ø16)		10/60
333 0018	G 1/2"	1/2"(ø16)		10/60

**1240C**

Pentru tub din cupru
Piulita cromata + inel de compresie pentru conexiuni 1/2" x 16

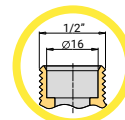

Cod	Dimensiune	Pret €	Ambalare
144 0084	10 x 1/2"(ø16)		10/400
144 0050	12 x 1/2"(ø16)		10/400
144 0067	14 x 1/2"(ø16)		10/400
144 0066	15 x 1/2"(ø16)		10/400

**1635C**

Pentru tub multistrat
Adaptor cromat pentru conexiuni 1/2" x 16

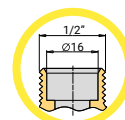

Cod	Dimensiune	Pret €	Ambalare
144 0065	14 x 2,0 - 1/2"(ø16)		10/350
144 0035	16 x 2,0 - 1/2"(ø16)		10/300
144 0079	16 x 2,25 - 1/2"(ø16)		10/300



9553
Cap termostatic cu element sensibil cu lichid incorporat (6-28 °C)

Cod	Dimensiune	Pret €	Ambalare
955 0025	M30 x 1,5		1/30



9553C
Cap termostatic cu element sensibil cu lichid incorporat. Cromat (6-28 °C)

Cod	Dimensiune	Pret €	Ambalare
955 0026	M30 x 1,5		1/30



9558
Cap termostatic cu element sensibil cu lichid la distanta (lungime capilar 2 m)

Cod	Dimensiune	Pret €	Ambalare
955 0003	M30 x 1,5		1/15



9551
Cap termostatic cu comanda la distanta. Lungime capilar 2 m

Cod	Dimensiune	Pret €	Ambalare
955 0029	M30 x 1,5		1/5



9553INS
Pereche de placute pentru limitarea temperaturii pentru cap termostatic 9553/9553C

Cod	Dimensiune	Pret €	Ambalare
955 0037	-		5/50



9553AM2
Kit antivandalizare și antideteriorare pentru cap termostatic 9553/9553C

Cod	Dimensiune	Pret €	Ambalare
955 0033	-		20/80



9553CHT
Cheie pentru kit antivandalism protecție cap termostatic 9553/9553C

Cod	Dimensiune	Pret €	Ambalare
955 0038	-		1/1



9553AM1
Maneta antivandalizare și antideteriorare pentru cap termostatic 9553/9553C

Cod	Dimensiune	Pret €	Ambalare
955 0036	-		1/4



9556
Cap termostatic electronic programabil. Interval de temperatura 8-28 °C

Cod	Dimensiune	Pret €	Ambalare
955 0015	M30 x 1,5		1/5



9556USB
Cheie USB pentru programarea capului termostatic electronic

Cod	Dimensiune	Pret €	Ambalare
955 0017	-		10/40



9564W

Cap termostatic electronic comunicare Wi-Fi. Sistemul „Tiemme GATE”. Domeniu de temperatura 6-28 °C

CARACTERISTICI TEHNICE:

- Alimentarea: nr. 2 baterii 1,5 V tip AA
- Funcționarea: ON, OFF, manuală, în regim automat
- Domeniu de reglare: +60C÷280C
- Tip conexiune: M30 x 1,5
- Adaptorii pentru toate tipurile de robineti uzuali prezenti pe piata
- Banda de frecvență Wi-Fi: 2,4 GHz
- Clasa: VIII (cu o comanda OpenTherm - releu 9564RS)
IV (cu o comanda ON/OFF - releu 9564RS)

Cod	Dimensiune	Pret €	Ambalare
955 0052	M30 x 1,5		1/4



9564ST

Sonda de temperatură cu Wi-Fi. Sistemul „TIEMME GATE”

CARACTERISTICI TEHNICE:

- Alimentarea: nr. 2 baterii 1,5 V tip AA
- Domeniu de reglare: 0 °C ÷ +50 °C
- Banda de frecvență Wi-Fi: 2,4 GHz

Cod	Dimensiune	Pret €	Ambalare
955 0053	0 °C ÷ + 50 °C		1/10



9564RS

Releu cu Wi-Fi. Sistemul „TIEMME GATE”

CARACTERISTICI TEHNICE:

- Alimentarea: 85 ÷ 230 Vac 50/60 Hz
- Iesire releu de contact: 5 A 230 V
- Control tip “OpenTherm” catre centrala termica
- Banda de frecvență cu Wi-Fi: 2,4 GHz

Cod	Dimensiune	Pret €	Ambalare
955 0054	-		1/10



Disponibil pentru



9564W-9564ST-9564RS EXEMPLU DE INSTALARE

SISTEM CENTRALIZAT

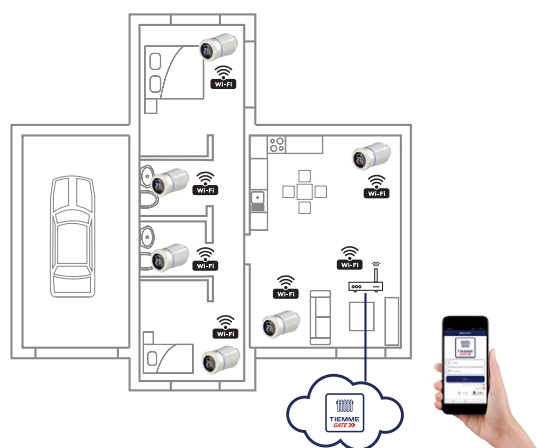

SISTEM AUTONOM

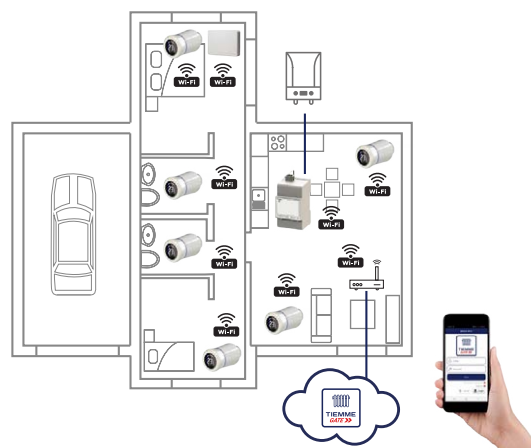

**9556W**

Cap termostatic electronic programabil wireless. Interval de temperatura 8-28 °C

Cod	Dimensiune	Pret €	Ambalare
955 0027	M30 x 1,5		1/5

**4601**

Termostat de ambient electronic cu trasmisie via radio

CARACTERISTICI TEHNICE:

- Display cu touchscreen
- Alimentare: 2 baterii AAA de 1,5 V
- Durata bateriei: 1 an
- Frecventa de transmisie: 433,92 MHz
- Functie VARA-IARNA-OFF
- Domeniu de reglare: 2-35°C
- Grad de precizie: reglabil de la +0,1 la +1°C (default+ 0,3°C)

Cod	Dimensiune	Pret €	Ambalare
957 0156	Electronic		1/10

**9580W**

Cronotermostat de ambient electronic cu touchscreen cu transmisie via radio

CARACTERISTICI TEHNICE:

- Display cu touchscreen
- Alimentare: 2 baterii AAA de 1,5 V
- Durata bateriei: 1 an
- Frecventa de transmisie: 433,92 MHz
- Iesire: in releu, liber de contact 5 A (230 Vac)
- Functie VARA-IARNA-OFF
- Programare saptamanala cu trei niveluri de temperatura
- Domeniu de reglare: 2-35°C
- Grad de precizie: reglabil de la $\pm 0,1$ la $\pm 1^\circ\text{C}$ (default+ 0,3°C)

Cod	Dimensiune	Pret €	Ambalare
957 0172	Electronic		1/10

 Cronotermostat disponibil art.9590 poate fi gestionat de la distanta prin aplicatie (vezi cap. 14)

9556W-4601-9580W**EXEMPLU DE INSTALARE**

Robinet termostaticabil cu pre-reglare, cap termostatic și robinet de retur (versiunea cu O-ring)

**331HKIT01**

Kit 3 piese compus din: robinet de colt TERMOSTATAT CU PRE-REGLARE, cap termostatic, robinet de retur cu racord pentru teava din fier



+ CU PRE-REGLARE

Cod	Dimensiune	Pret €	Ambalare
331 0046	G 3/8"		1/10
331 0047	G 1/2"		1/10
331 0048	G 3/4"		1/10

**332HKIT01**

Kit 3 piese compus din: robinet de colt TERMOSTATAT CU PRE-REGLARE, cap termostatic, robinet de retur cu racord pentru tub din cupru, Pex și multistrat

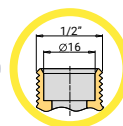

+ CU PRE-REGLARE

Cod	Dimensiune	Iesiri	Pret €	Ambalare
331 0052	G 3/8"	1/2" (ø16)		1/10
331 0053	G 1/2"	1/2" (ø16)		1/10

Robinet termostaticabil cu pre-reglare, cap termostatic și robinet de retur "EXCEL" (versiunea cu O-ring)

**331HKIT**

Kit 3 piese compus din: robinet de colt TERMOSTATAT CU PRE-REGLARE, cap termostatic, robinet de retur EXCEL cu racord pentru teava din fier



+ CU PRE-REGLARE

Cod	Dimensiune	Pret €	Ambalare
331 0036	G 3/8"		1/10
331 0037	G 1/2"		1/10
331 0045	G 3/4"		1/10

**332HKIT**

Kit 3 piese compus din: robinet de colt TERMOSTATAT CU PRE-REGLARE, cap termostatic, robinet de retur EXCEL cu racord pentru tub din cupru, Pex și multistrat

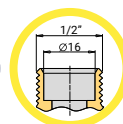

+ CU PRE-REGLARE

Cod	Dimensiune	Iesiri	Pret €	Ambalare
331 0040	G 3/8"	1/2" (ø16)		1/10
331 0041	G 1/2"	1/2" (ø16)		1/10



Robinet termostaticabil, cap termostatic, si robinet de retur "EXCEL" (versiune cu O-ring)



3308KIT04 3308KIT04R

Kit 3 piese compus din: robinet termostaticabil de colt, cap termostatic, robinet de retur EXCEL cu racord pentru teava din fier

Cod	Dimensiune	Pret €	Ambalare
330 0177	G 1/2"		1/20
Versiunea cu O-ring			
330 0153	G 1/2"		1/20



3303KIT04 3303KIT04R

Kit 3 piese compus din: robinet termostaticabil de colt, cap termostatic, robinet de retur EXCEL cu racord pentru tub din cupru, Pex si multistrat

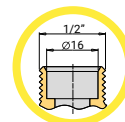

Cod	Dimensiune	Iesiri	Pret €	Ambalare
330 0178	G 3/8"	1/2"(ø16)		1/20
Versiunea cu O-ring				
330 0155	G 1/2"	1/2"(ø16)		1/20



4490
TIEMME BOX 1 pentru
reglarea incalzirii in functie de
temperatura ambientala

Cod	Dimensiune	Pret €	Ambalare
449 0001	3/4" (ø18)		1/4



4490C
TIEMME BOX 1 pentru
reglarea incalzirii in functie de
temperatura ambientala.
Versiunea cromata

Cod	Dimensiune	Pret €	Ambalare
449 0021	3/4" (ø18)		1/4

4490 - 4490C EXEMPLU DE UTILIZARE

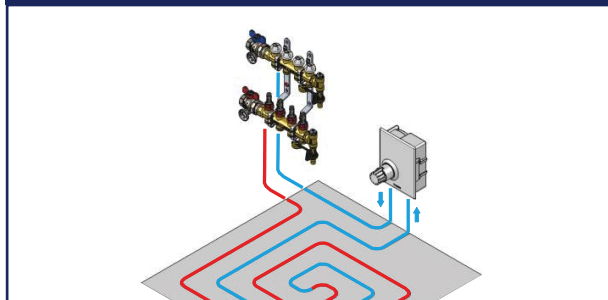

4491
TIEMME BOX 2 pentru limitarea
temperaturii de retur a
circuitului de incalzire (RTL)

Cod	Dimensiune	Pret €	Ambalare
449 0002	3/4" (ø18)		1/4



4491C
TIEMME BOX 2 pentru limitarea
temperaturii de retur a
circuitului de incalzire (RTL).
Versiunea cromata

Cod	Dimensiune	Pret €	Ambalare
449 0022	3/4" (ø18)		1/4

4491 - 4491C EXEMPLU DE UTILIZARE

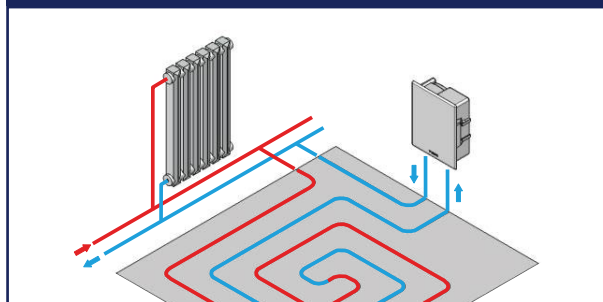

4492
TIEMME BOX 3 pentru
reglarea incalzirii in functie
de temperatura ambientala si
limitarea temperaturii de retur a
circuitului de incalzire (RTL)

Cod	Dimensiune	Pret €	Ambalare
449 0003	3/4" (ø18)		1/4



4492C
TIEMME BOX 3 pentru
reglarea incalzirii in functie
de temperatura ambientala si
limitarea temperaturii de retur
a circuitului de incalzire (RTL).
Versiunea cromata

Cod	Dimensiune	Pret €	Ambalare
449 0023	3/4" (ø18)		1/4

4492 - 4492C EXEMPLU DE UTILIZARE

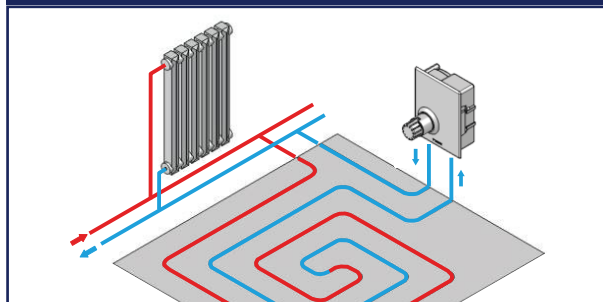



3326
Robinet manual SERIA MAXIMA
de tur de colt pentru conectare
pe tub de fier



Cod	Dimensiune	Pret €	Ambalare
332 0001	G 1/2"		1/60
332 0008	G 3/4"		1/60
Versiunea cu O-ring			
332 0010	G 1/2"		1/60
332 0012	G 3/4"		1/60



3325
Robinet manual SERIA MAXIMA
de tur drept pentru conectare
pe tub de fier



Cod	Dimensiune	Pret €	Ambalare
332 0003	G 1/2"		1/60
332 0009	G 3/4"		1/60
Versiunea cu O-ring			
332 0011	G 1/2"		1/60
332 0014	G 3/4"		1/60



3321
Robinet manual SERIA MAXIMA
de tur de colt montare
conectare pe tub de cupru/Pex/
multistrat

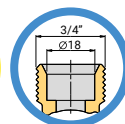
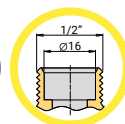

Cod	Dim.	Iesiri	Pret €	Ambalare
332 0034	G 1/2"	1/2" (ø16)		10/60
332 0036	G 1/2"	3/4" (ø18)		10/60
Versiunea cu O-ring				
332 0006	G 1/2"	1/2" (ø16)		10/60
332 0037	G 1/2"	3/4" (ø18)		10/60



3320
Robinet manual SERIA MAXIMA
de tur drept pentru montare pe
tub de cupru/Pex/multistrat

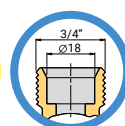
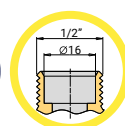

Cod	Dim.	Iesiri	Pret €	Ambalare
332 0028	G 1/2"	1/2" (ø16)		10/60
332 0031	G 1/2"	3/4" (ø18)		10/60
Versiunea cu O-ring				
332 0029	G 1/2"	1/2" (ø16)		10/60
332 0032	G 1/2"	3/4" (ø18)		10/60

**3266**

Robinet manual de tur de colt pentru montare pe tub de fier



Cod	Dimensiune	Pret €	Ambalare
326 0037	G 3/8"		10/60
326 0038	G 1/2"		10/60
326 0039	G 3/4"		10/60
Versiunea cu O-ring			
326 0047	G 3/8"		10/60
326 0040	G 1/2"		10/60
326 0041	G 3/4"		10/60

**3266PTFE**

Robinet manual de tur de colt pentru conectare pe tub de fier. SEMIOLANDEZ CU GARNITURA PTFE



Cod	Dimensiune	Pret €	Ambalare
326 0111	G 1/2"		10/60

Pina la terminarea stocului

**3265**

Robinet manual de tur drept pentru montare pe tub de fier



Cod	Dimensiune	Pret €	Ambalare
326 0042	G 3/8"		10/60
326 0043	G 1/2"		10/60
326 0044	G 3/4"		10/60
Versiunea cu O-ring			
326 0048	G 3/8"		10/60
326 0045	G 1/2"		10/60
326 0046	G 3/4"		10/60

**3263**

Robinet de tur-coltar, serie NEW EXCEL pentru conectare pe tub de cupru prin sudura



Cod	Dim.	Iesiri	Pret €	Ambalare
326 0053	G 1/2"	Ø 15		10/60
Versiunea cu O-ring				
326 0106	G 1/2"	Ø 15		10/60

**3261**

Robinet manual de tur de colt pentru conectare pe tub de cupru/Pex/multistrat

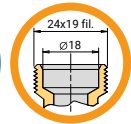
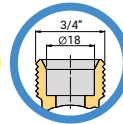
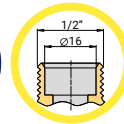

Cod	Dim.	Iesiri	Pret €	Ambalare
326 0029	G 3/8"	1/2" (Ø16)		10/60
326 0030	G 1/2"	1/2" (Ø16)		10/60
326 0105	G 1/2"	3/4" (Ø18)		1/60
326 0049	G 1/2"	24 x 19 fil (Ø18)		1/60
326 0082	G 3/4"	24 x 19 fil (Ø18)		1/60
Versiunea cu O-ring				
326 0031	G 3/8"	1/2" (Ø16)		10/60
326 0032	G 1/2"	1/2" (Ø16)		10/60
326 0050	G 1/2"	24 x 19 fil (Ø18)		1/60
326 0083	G 3/4"	24 x 19 fil (Ø18)		1/60

versiune cromata



**3260**

Robinet manual de tur drept
pentru montare pe tub de
cupru/Pex/multistrat

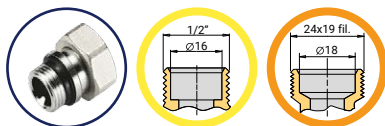

Cod	Dim.	Iesiri	Pret €	Ambalare
326 0033	G 3/8"	1/2" (ø16)		10/60
326 0034	G 1/2"	1/2" (ø16)		10/60
326 0051	G 1/2"	24 x 19 fil (ø18)		1/60
Versiunea cu O-ring				
326 0035	G 3/8"	1/2" (ø16)		10/60
326 0036	G 1/2"	1/2" (ø16)		10/60
326 0052	G 1/2"	24 x 19 fil (ø18)		1/60

versiune cromata

**3236EXCEL**

Robinet de retur de colt pentru montare pe tub de fier



Cod	Dimensiune	Pret €	Ambalare
323 0009	G 3/8"		10/60
323 0001	G 1/2"		10/60
323 0027	G 1/2"		10/60
323 0013	G 3/4"		10/60
Versiunea cu O-ring			
323 0041	G 3/8"		10/60
323 0008	G 1/2"		10/60
323 0023	G 3/4"		10/60

Cu capac nichelat

Versiunea cromata

**3236EXPTFE**

Robinet de retur de tur de colt pentru conectare pe tub de fier. SEMIOLANDEZ CU GARNITURA PTFE



Cod	Dimensiune	Pret €	Ambalare
323 0056	G 1/2"		10/60

Pina la terminarea stocului

**3235EXCEL**

Robinet de retur drept pentru montare pe tub de fier



Cod	Dimensiune	Pret €	Ambalare
323 0010	G 3/8"		10/60
323 0003	G 1/2"		10/60
323 0014	G 3/4"		10/60
Versiunea cu O-ring			
323 0042	G 3/8"		10/60
323 0016	G 1/2"		10/60
323 0018	G 3/4"		10/60

Cu capac nichelat

**3233EXCEL**

Robinet de retur-coltar, serie EXCEL pentru conectare pe tub de cupru prin sudura

Cod	Dim.	Iesiri	Pret €	Ambalare
323 0038	G 1/2"	Ø 15		10/60
Versiunea cu O-ring				
323 0054	G 1/2"	Ø 15		10/60

**3231EXCEL**

Robinet de retur de colt pentru montare pe tub de cupru/Pex/multistrat

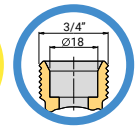
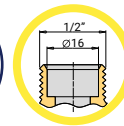

Cod	Dim.	Iesiri	Pret €	Ambalare
323 0004	G 3/8"	1/2" (Ø16)		10/60
323 0002	G 1/2"	1/2" (Ø16)		10/60
323 0053	G 1/2"	3/4" (Ø18)		1/60
Versiunea cu O-ring				
323 0005	G 3/8"	1/2" (Ø16)		10/60
323 0006	G 1/2"	1/2" (Ø16)		10/60

versiune cromata

cu capac cromat

**3231EXPTFE**

Robinet de retur de tur de colt pentru conectare pe tub de cupru/Pex/multistrat. SEMIOLANDEZ CU GARNITURA PTFE

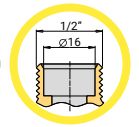

Cod	Dim.	Iesiri	Pret €	Ambalare
323 0057	G 1/2"	1/2" (Ø16)		10/60

Pina la terminarea stocului

12 ROBINETI DE RETUR SERIA "EXCEL"



3230EXCEL

Robinet de retur drept pentru montare pe tub de cupru/Pex/multistrat

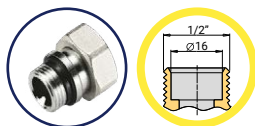

Cod	Dimensiune	Iesiri	Pret €	Ambalare
323 0012	G 3/8"	1/2"(ø16)		10/60
323 0007	G 1/2"	1/2"(ø16)		10/60
Versiunea cu O-ring				
323 0015	G 3/8"	1/2"(ø16)		10/60
323 0019	G 1/2"	1/2"(ø16)		10/60

12 KIT ROBINETI MANUALI

Robineti manuali tur/retur "EXCEL"



3266KIT01 3266KITR01

Kit compus din: robinet de tur si robinet de retur cu racord pentru tub fier



Cod	Dimensiune	Pret €	Ambalare
326 0074	G 1/2"		60/60
Versiunea cu O-ring			
326 0075	G 1/2"		60/60



3261KIT01 3261KITR01

Kit compus din: robinet de tur si robinet de retur cu racord pentru tub cupru/Pex/multistrat

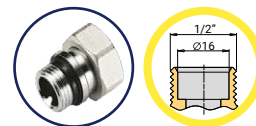

Cod	Dimensiune	Iesiri	Pret €	Ambalare
326 0076	G 1/2"	1/2"(ø16)		60/60
Versiunea cu O-ring				
326 0077	G 1/2"	1/2"(ø16)		60/60



3383K

Robinet termostatic „DUAL” cromat pentru instalatii mono/ bitub cu intrare reversibila și sonda metalică de 15 cm. Conexiuni interax 38 mm

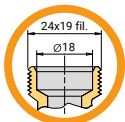

Cod	Dim.	Iesiri	Pret €	Ambalare
338 0002	G 1/2"	24 x 19 fil (Ø18)		1/20

3383K

EXEMPLU DE UTILIZARE

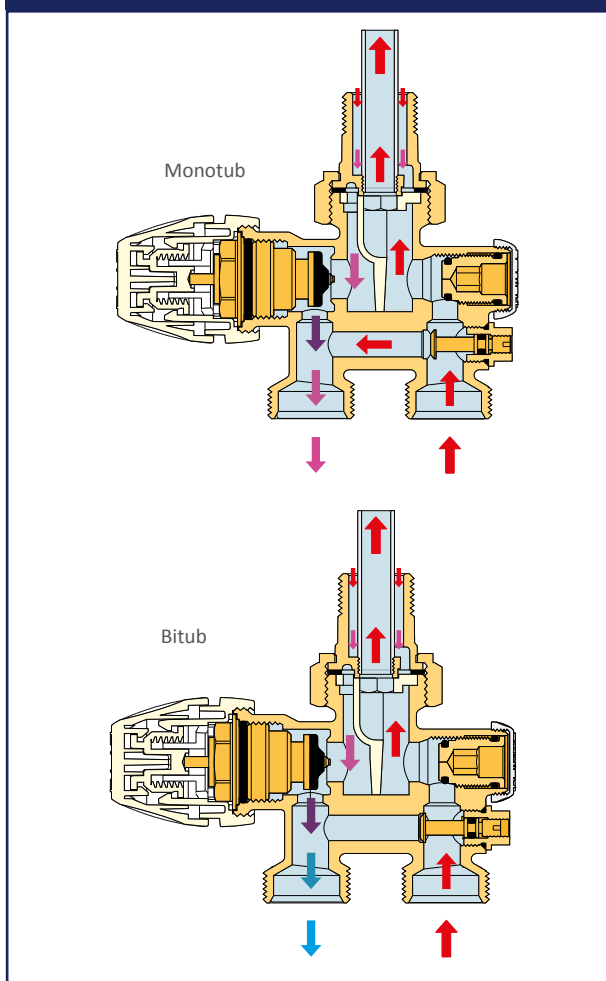

3381KSX

Robinet coltar termostatic „DUAL” cromat pentru instalatii mono/bitub cu intrare reversibila si sonda metalica L=15 cm. Conexiuni interax 38mm

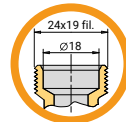

i cu maneta de comanda pe stanga

Cod	Dim.	Iesiri	Pret €	Ambalare
338 0028	G 1/2"	24 x 19 fil (Ø18)		1/20



3381KDX

Robinet coltar termostatic „DUAL” cromat pentru instalatii mono/bitub cu intrare reversibila si sonda metalica L=15 cm. Conexiuni interax 38mm

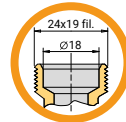

i cu maneta de comanda pe dreapta

Cod	Dim.	Iesiri	Pret €	Ambalare
338 0038	G 1/2"	24 x 19 fil (Ø18)		1/20



**3384K**

Robinet monotub cromat cu sonda metalica L= 15 cm. Interaxa racorduri 36 mm. Filet cu O-ring

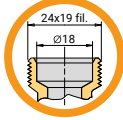

Cod	Dim.	Iesiri	Pret €	Ambalare
338 0015	G 1/2"	24 x 19 fil (ø18)		1/20

3384K

EXEMPLU DE UTILIZARE

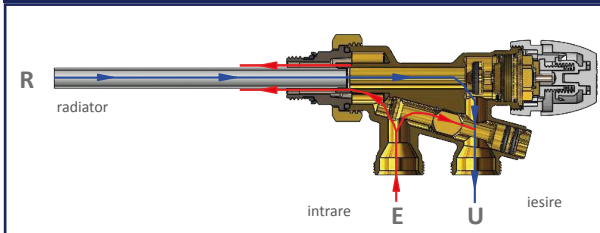
**3387K**

Robinet monotub compact cromat cu sonda metalica L= 15 cm. Interaxa racorduri 36 mm. Filet cu O-ring

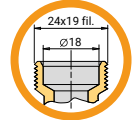

Cod	Dim.	Iesiri	Pret €	Ambalare
338 0034	G 1/2"	24 x 19 fil (ø18)		1/20

3387K

EXEMPLU DE UTILIZARE

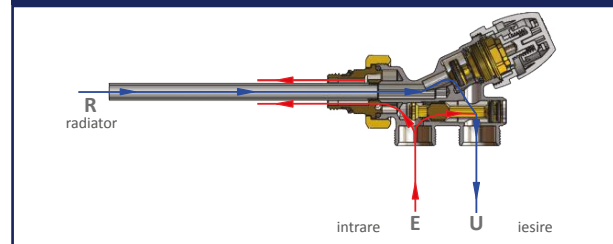
**3386K**

Robinet bitub cromat cu sonda metalica L= 15 cm. Interaxa racorduri 36 mm. Filet cu O-ring

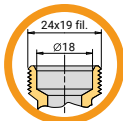

Cod	Dim.	Iesiri	Pret €	Ambalare
338 0022	G 1/2"	24 x 19 fil (ø18)		1/20

3386K

EXEMPLU DE UTILIZARE

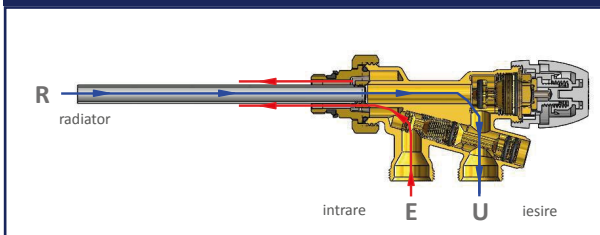
**3388K**

Robinet bitub compact cromat cu sonda metalica L= 15 cm. Interaxa racorduri 36 mm. Filet cu O-ring

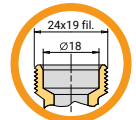

Cod	Dim.	Iesiri	Pret €	Ambalare
338 0035	G 1/2"	24 x 19 fil (ø18)		1/20

3388K

EXEMPLU DE UTILIZARE

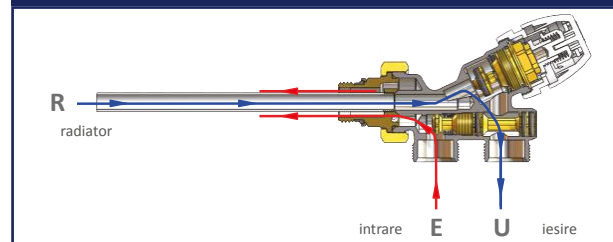



3383SOND

Sonda metalica pentru 3381K, 3383K, 3384K, 3385K si 3386K

Cod	Dimensiune	Pret €	Ambalare
338 0039	Ø10 x 1,0 L = 15 cm		5/50
338 0029	Ø 10 x 1,0 L = 45 cm		5/50



3370K

Distribuitoare cu racorduri de alimentare din pardoseala, cu debit pe calorifer **50%**. Racorduri 24x19 fil (Ø18) cu interaxa 38 mm - racord teava cupru Ø 15 la calorifer

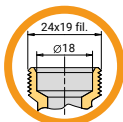

Cod	Dim.	Iesiri	Pret €	Ambalare
337 0003	G 1/2"	24 x 19 fil (Ø18)		5/25



3375K

Distribuitoare cu racorduri de alimentare din pardoseala, cu debit pe calorifer **100%**. Racorduri 24x19 fil (Ø18) cu interaxa 38 mm - racord teava cupru Ø 15 la calorifer

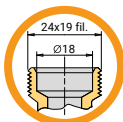

Cod	Dim.	Iesiri	Pret €	Ambalare
337 0002	G 1/2"	24 x 19 fil (Ø18)		5/25



3371K

Distribuitoare cu racorduri de alimentare din perete, cu debit pe calorifer **50%**. Racorduri 24x19 (Ø18) cu interaxa 38 mm - racord teava cupru Ø 15 la calorifer

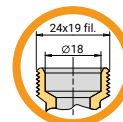

Cod	Dim.	Iesiri	Pret €	Ambalare
337 0005	G 1/2"	24 x 19 fil (Ø18)		5/25



3376K

Distribuitoare cu racorduri de alimentare din perete, cu debit pe calorifer **100%**. Racorduri 24x19 (Ø18) cu interaxa 38 mm - racord teava cupru Ø 15 la calorifer

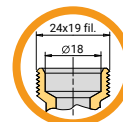

Cod	Dim.	Iesiri	Pret €	Ambalare
337 0006	G 1/2"	24 x 19 fil (Ø18)		5/25



3365N

Cot nichel termostatizabil cu niplu curbat si racord pentru tub de cupru/Pex/multistrat

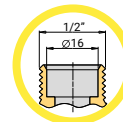

Cod	Dimensiune	Iesiri	Pret €	Ambalare
330 0197	G 1/2"	1/2"(Ø16)		10/60



3391

Distribuitoare bitub pentru calorifere de oțel, cu grup de robineti termostaticizabili încorporat. Alimentare din pardoseala cu racorduri pentru calorifer 3/4"x18 (Eurocono)

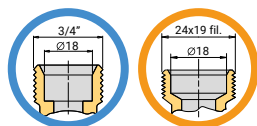

Cod	Dimensiune	Pret €	Ambalare
339 0001	3/4" F - 3/4"(ø18)		15/45
339 0010	3/4" F - 24 x 19 fil (ø18)		15/45

versiune nichelata
versiune cromata



3393

Distribuitoare bitub pentru calorifere de oțel, cu grup de robineti termostaticizabili încorporat. Alimentare din perete cu racorduri pentru calorifer 3/4"x18 (Eurocono)

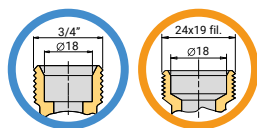

Cod	Dimensiune	Pret €	Ambalare
339 0002	3/4" F - 3/4"(ø18)		10/30
339 0004	3/4" F - 24 x 19 fil (ø18)		10/30

versiune nichelata
versiune cromata

3391 - 3393 EXEMPLU DE UTILIZARE

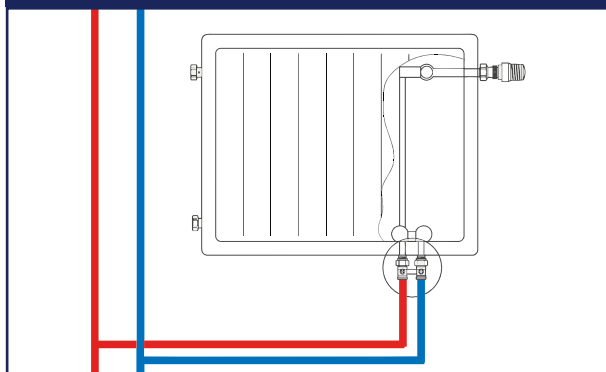

3391BY

Distribuitoare bitub pentru calorifere de oțel, cu grup de robineti termostaticizabili încorporat și by-pass. Alimentare din pardoseala cu racorduri pentru calorifer 3/4"x18 (Eurocono)

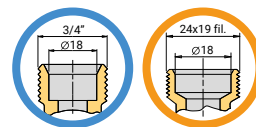

SI BY-PASS

Cod	Dimensiune	Pret €	Ambalare
339 0007	3/4" F - 3/4"(ø18)		10/30
339 0006	3/4" F - 24 x 19 fil (ø18)		10/30

versiune nichelata
versiune cromata



3393BY

Distribuitoare bitub pentru calorifere de oțel, cu grup de robineti termostaticizabili încorporat și by-pass. Alimentare din perete cu racorduri pentru calorifer 3/4"x18 (Eurocono)

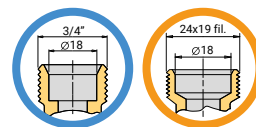

SI BY-PASS

Cod	Dimensiune	Pret €	Ambalare
339 0011	3/4" F - 3/4"(ø18)		10/30
339 0005	3/4" F - 24 x 19 fil (ø18)		10/30

versiune nichelata
versiune cromata



3390RID

Reductie pentru racord 1/2" feminin

Cod	Dimensiune	Pret €	Ambalare
339 0003	3/4" x 1/2"		10/250



3345N

Piulita si inel din lama pentru montarea pe tub din fier G1/2" si pe tub din cupru

Cod	Dimensiune	Pret €	Ambalare
327 0010	10 x 1/2"		10/500
327 0009	12 x 1/2"		10/500
327 0011	14 x 1/2"		10/500
327 0002	15 x 1/2"		10/500
327 0012	16 x 1/2"		10/500

3345N

EXEMPLU DE UTILIZARE

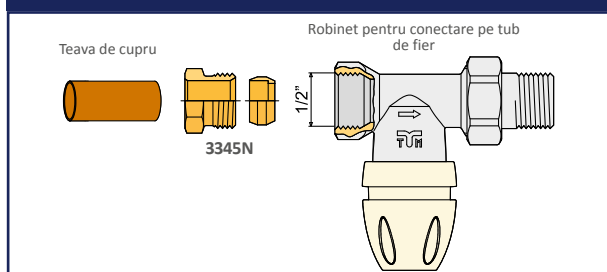

3340C

Rozeta decorativa universala cromat

Cod	Dimensiune	Pret €	Ambalare
327 0075	Ø10 - Ø16		10/100



3342

Rozeta decorativa universala dubla cu interaxa 38 mm

Cod	Dimensiune	Pret €	Ambalare
327 0004	Ø10 - Ø18		1/50



9550

Cap de actionare pentru robinetii seria "3300"

Cod	Dimensiune	Pret €	Ambalare
327 0006	-		5/50



9552P06

Cap manual pentru robinetii seria "MAXIMA"

Cod	Dimensiune	Pret €	Ambalare
327 0038	-		5/50



9552NX

Cap manual pentru robinetii seria "NEW EXCEL"

Cod	Dimensiune	Pret €	Ambalare
327 0054	-		5/50





3338
Racord olandez cu garnitura

Cod	Dimensiune	Pret €	Ambalare
327 0007	3/8"		5/100
327 0003	1/2"		5/100
327 0005	3/4"		5/100



3350
Supapa de aerisire pentru radiatoare

Cod	Dimensiune	Pret €	Ambalare
198 0021	1/8"		10/500
198 0020	1/4"		10/500
198 0015	3/8"		10/500
198 0016	1/2"		10/500



3351
Supapa de aerisire pentru radiatoare, cu garnitura de etansare

Cod	Dimensiune	Pret €	Ambalare
198 0010	1/4"		10/500
198 0008	3/8"		10/500
198 0006	1/2"		10/500



3352
Supapa de aerisire pentru radiatoare

Cod	Dimensiune	Pret €	Ambalare
198 0049	1/4"		10/500
198 0047	3/8"		10/500
198 0018	1/2"		10/500



3300ATTR
Echipament care permite interventia rapida de înlocuire a ventilului încorporat în robinetii termostaziabili chiar si atunci când instalatia este în functiune

Cod	Dimensiune	Pret €	Ambalare
327 0057	-		1/2



H9705
Ventil alamă pentru robinetii termostatzabili

Cod	Dimensiune	Pret €	Ambalare
758 0069	-		10/50



H9706CAP
Capac numerotat 6 pozitii pentru ventil alamă cu pre-reglare

Cod	Dimensiune	Pret €	Ambalare
327 0055	-		10/100



H9706CV
Ventil alamă cu pre-reglare afisată pentru robinetii termostatzabili

Cod	Dimensiune	Pret €	Ambalare
758 0070	-		10/50



9568

Servocomanda electrotermica pentru robinet termostaticabil de inchidere cu indicator de cursa. NORMAL INCHIS (pentru robineti termostaticabili)

Cod	Dimensiune	Pret €	Ambalare
450 0543	24V		1/20
450 0539	230V		1/20
450 0545	24V		1/20
450 0541	230V		1/20

Versiuni cu microinterrupator auxiliar

9568

EXEMPLU DE INSTALARE

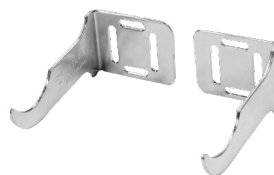

1829Z

Set suporturi de fixare radiator











Cod	Dimensiune	Pret €	Ambalare
076 0002	unica		25/100



13A Sisteme de pardoseli radiante

Introducere		264
Sistem de tip rezidential/tertiar		268
Echipamente		278

13B Colectoare si grupuri de amestec pentru distributie

Set colectoare "Floor" din alama stantata 1"		279
Set colectoare "Floor" din alama stantata 1" 1/4		281
Set colectoare "Floor" din alama stantata cu filet fazat 1"		283
Set colectoare bara din alama - 1"		285
Set colectoare din otel-inox AISI 304L - 1"		287
Accesorii pentru colectoare		290
Adaptoare pentru colectoare		295
Set colectoare "INDUSTRIAL FLOOR" din alama stantata - 1" 1/2		296
Grupuri de amestec - 1"		291
Vana deviatie/amestec		302
Grup de amestec si distributie cu punct fix - 1"		303
Accesorii pentru grupuri de amestec		308



13_A DE CE UN SISTEM DE INCALZIRE PRIN PARDOSEALA TIEMME?

CALDURA ESTE DISTRIBUITA MAI BINE

Radiatoarele se bazeaza pe circulatia aerului prin convecție impingand aerul cald in partea de sus si pe cel rece in partea de jos. In cazul incalzirii prin pardoseala schimbul termic se produce prin radiatie, fenomen care garanteaza o temperatura constanta in ambient.

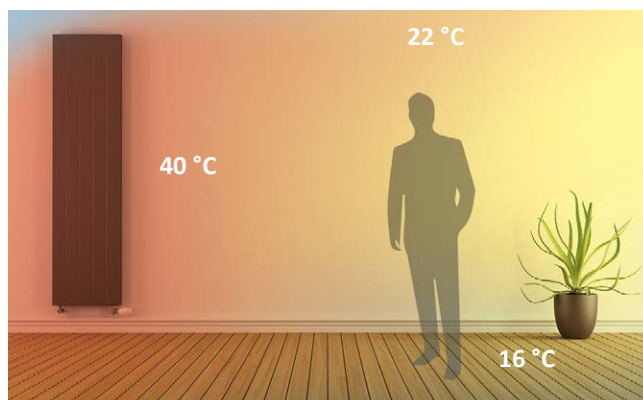

Incalzirea cu radiatoare

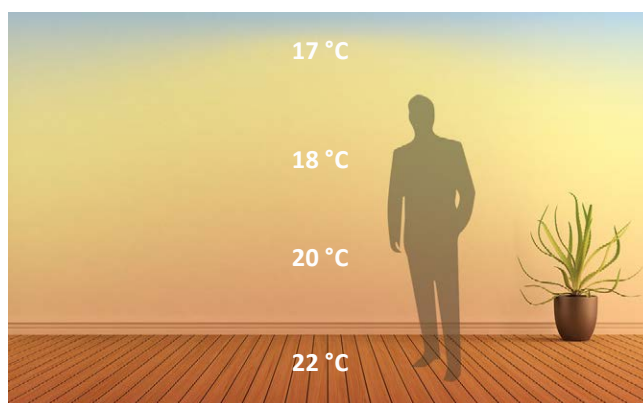

Incalzirea prin pardoseala

COMPATIBILITATE CU ENERGIILE REGENERABILE

Un sistem de incalzire cu radiatoare necesita o centrala cu combustibil gazos sau lichid care poate ridica temperatura apei la o valoare intre 70 si 80°C. Instalatia de incalzire prin pardoseala lucreaza la temperaturi mult inferioare-cuprinse intre 35-40 °C – si din aceste motive ofera o compatibilitate maxima cu sursele de energie mai ecologice pentru mediul inconjurator, precum cazane cu peleti, pompe de caldura si sisteme solare integrate.

REDUCEREA PRAFULUI, ACARIENI SI MUCEGAI

Prezenta radiatoarelor produce praf care apoi se imprastie deranjant in mediul ambient prin efectul de convecție. In cazul incalzirii prin pardoseala aceasta problema se reduce simtitor astfel se reduce si prezenta acarienilor si mucegaiului.

LIBERTATE DEPLINA IN ORGANIZAREA SPATIULUI INTERN

Radiatoarele limiteaza spatiul intern mentinand inutilizabili peretii pe care sunt montate. Instalatia de incalzire prin pardoseala permite castigarea unui spatiu mare lasand peretii in intregime liberi.

LIBERTATE DEPLINA IN ALEGEREA PARDOSELII

Incalzirea radianta este compatibila cu mai multe tipuri de pardoseli: gresie, mocheta. Unica grija priveste lemnul pentru care se va acorda o atentie majora in alegerea unui parchet stabil si de dimensiuni reduce.



Grafitul este una dintre formele alotrope ale carbonului.

Are o structură cristalină cu atomi de carbon dispuși în straturi paralele formând astfel o rețea de hexagoane regulate cu un atom de carbon în vârf. Datorită acestei structuri moleculare speciale de tip fagure, particulele de grafit absorb și reflectă căldura stocată și reduc la minimum transmiterea căldurii prin radiație.

Tocmai pentru a profita de această proprietate, Tiemme a ales să ofere panouri izolante din grafit caracterizate printr-o putere izolatoare mai mare:

- **NEW CLASSIC GRAPHITE**
- **TECHNO GRAPHITE CAM**

Adăugarea de aditivi vă permite să reduceți coeficientul de conductivitate termică până la valoarea de 0,030 W/mk, făcând posibilă respectarea standardului UNI EN 1264 cu o grosime mai mică a stratului izolator al panoului.



Efesto este software-ul creat de Tiemme și destinat tuturor acelor profesioniști care au nevoie de suport IT care simplifică faza de proiectare a sistemului radiant, fie că este podea, tavan sau perete.

Datorită ușurinței sale de utilizare, vă permite să regăsiți cu ușurință gama Tiemme și să identificați rapid produsele necesare dezvoltării fiecărui proiect.

Iată câteva puncte forte care l-au făcut pe Efesto atât de popular:

- Învățare rapidă pentru faza de proiectare;
- Crearea automată a listelor complete de materiale;
- Abilitatea de a importa și exporta desene în format DWG®;
- Posibilitatea de vizualizare a proiectelor atât în plan cât și pe verticală;
- Funcția de dispunere automată a serpentinelor pentru sisteme de pardoseală radiantă;
- Proiectare sisteme de încălzire și răcire.

Cu Efesto este posibil să se dezvolte orice tip de proiect din gama sistemelor radiante. În special:

- Clădiri de locuit, vile, blocuri sau alte clădiri de uz civil;
- Hale sau alte clădiri de uz industrial;
- Școli, lăcașuri de cult, centre sportive sau alte clădiri de uz public;
- Birouri, puncte de vânzare cu amănuntul sau alte clădiri de uz terțiar.

Efesto este un soft simplu și extrem de versatil, un produs indispensabil pentru cei care vor să facă un pas înainte în ceea ce privește proiectarea.





Sistemele radiante Tiemme oferă o gamă completă de aplicații care vor satisface cel mai bine toate nevoile de confort în orice mediu de locuit.

Fiecare sistem este rezultatul unei dezvoltări continue printre cele mai bune tehnologii și cele mai bune materiale pentru a oferi clienților soluții de ultimă oră atât în ceea ce privește izolația termică și/sau acustică cât și în ceea ce privește eco-durabilitatea.

Dar dacă performanța unui sistem este importantă, la fel de importantă este fiabilitatea acestuia.

Tiemme este foarte conștient de faptul că un sistem radiant nu trebuie să provoace îngrijorări și din acest motiv pune fiabilitatea pe primul loc pe scara sa de valori prin introducerea unei garanții de zece ani pentru sistemele sale. Așa s-a născut Garanta zero10.



GARANȚIE 10 ANI

SISTEME RADIANTE DE ÎNCĂLZIRE/RĂCIRE

Tiemme Raccorderie S.p.A. garantează pentru 10 ani țevile Cobra-pex Oxistop, Al-Cobrapex și accesoriile aferente din alama Tiemme folosite în cadrul instalației radiante. Garanția se acordă prin eliberarea unui certificat numit: **GARANȚIA ZERO10 "Zero Riscuri timp de 10 Ani!"**. Respectivul certificat se eliberează exclusiv în urma unei cereri speciale înaintate de către instalator.

a) Client:

b) Proiectant responsabil: Adresă

c) Proiect de referință: Adresă

d) Locul instalării:

e) Tip de sistem:

f) Tip țevă: CobraPex Oxistop Al-CobraPex

g) Accesorii din alama, oțel, poliamidă:

h) Compania responsabilă cu instalarea: Adresă

i) Distribuitor:

l) Data finalizării instalației:

m) Data testării/pornirii instalației:

Declar pe propria răspundere că materialul a fost instalat și supus testelor, conform instrucțiunilor tehnice publicate în cataloagele tehnice ale producătorului și/sau în standardele de referință și/sau de ștampilă și semnătură instalator:

Data:

Garanția este valabilă numai dacă are toate rubricile completate și dacă este transmisă către TIEMME RACCORDERIE S.p.A. în termen de 30 de zile de la data testării sistemului/pornirii instalației.





G210.BAD.003

1/3

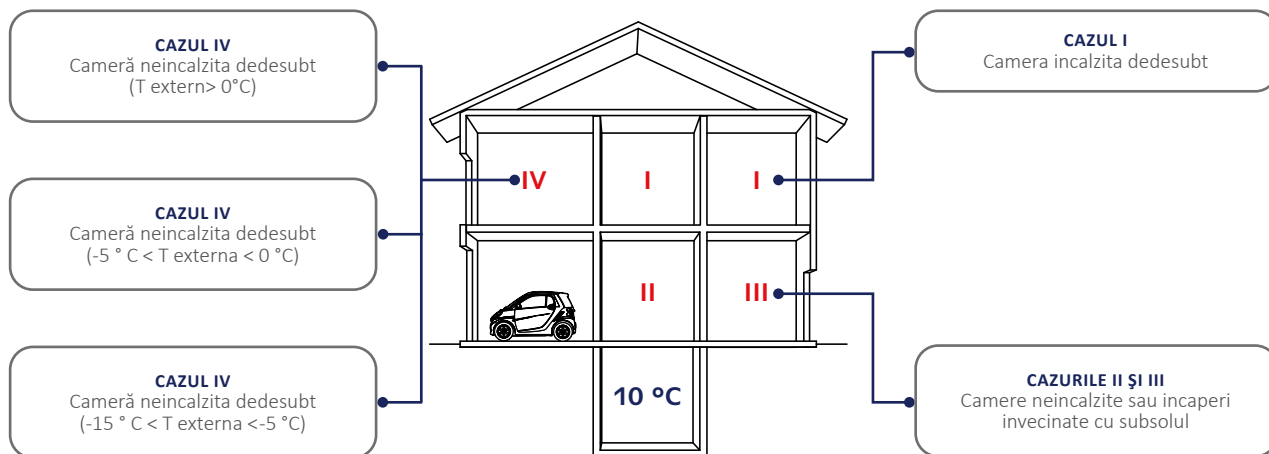

ORIGINAL ITALIAN TRADEMARK

GHID PENTRU ALEGEREA GROSIMILOR CONFORM UNI EN 1264



	R_D ($\text{m}^2\text{K}/\text{W}$)	Grosimea totală echivalentă minimă necesară (mm)	
		EPS cu Grafīt $\lambda_D = 0,030$ (W/mK)	EPS $\lambda_D = 0,035$ (W/mK)
CAZUL I	0,75	22,5	26,5
CAZURILE II și III	1,25	37,5	44
CAZUL IV ($T_{\text{externa}} > 0^{\circ}\text{C}$)	1,25	37,5	44
CAZUL IV ($-5^{\circ}\text{C} < T_{\text{externa}} < 0^{\circ}\text{C}$)	1,50	45	53
CAZUL IV ($-15^{\circ}\text{C} < T_{\text{externa}} < -5^{\circ}\text{C}$)	2,00	60	70



SOLUȚIILE TIEMME

NEW CLASSIC ȘI NEW CLASSIC GRAPHITE

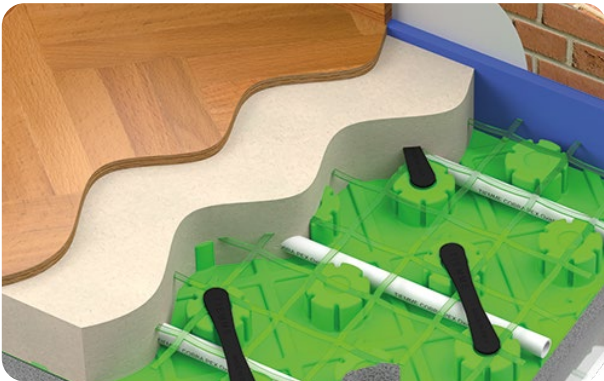

TECHNO GRAPHITE CAM

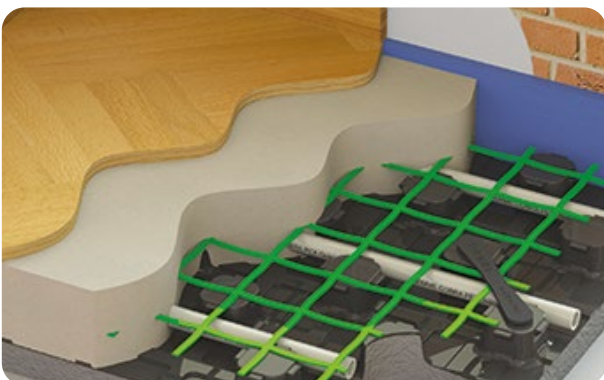

BASIC



13A NEW CLASSIC ȘI NEW CLASSIC GRAPHITE

INTRODUCERE

Soluție ideală pentru sistemele de încălzire și răcire rezidențiale și comerciale. Panoul cu nuturi este rezultatul cuplării dintre o placă de polistiren expandat cu aditiv cu grafit (NEW CLASSIC GRAPHITE), obținută cu cele mai bune tehnici de turnare, și o folie de polistiren cu grosimea de 0,16 mm. Rezultatul este un panou ușor de utilizat și disponibil în diferite grosimi de strat izolator, de la 20 la 60 mm, toate certificate și cu o rezistență excelentă la compresiune. Cuplarea între panouri este garantată de un sistem special de cuplare cu îmbinări perimetrice. Pas de instalare 50 mm și multipli.

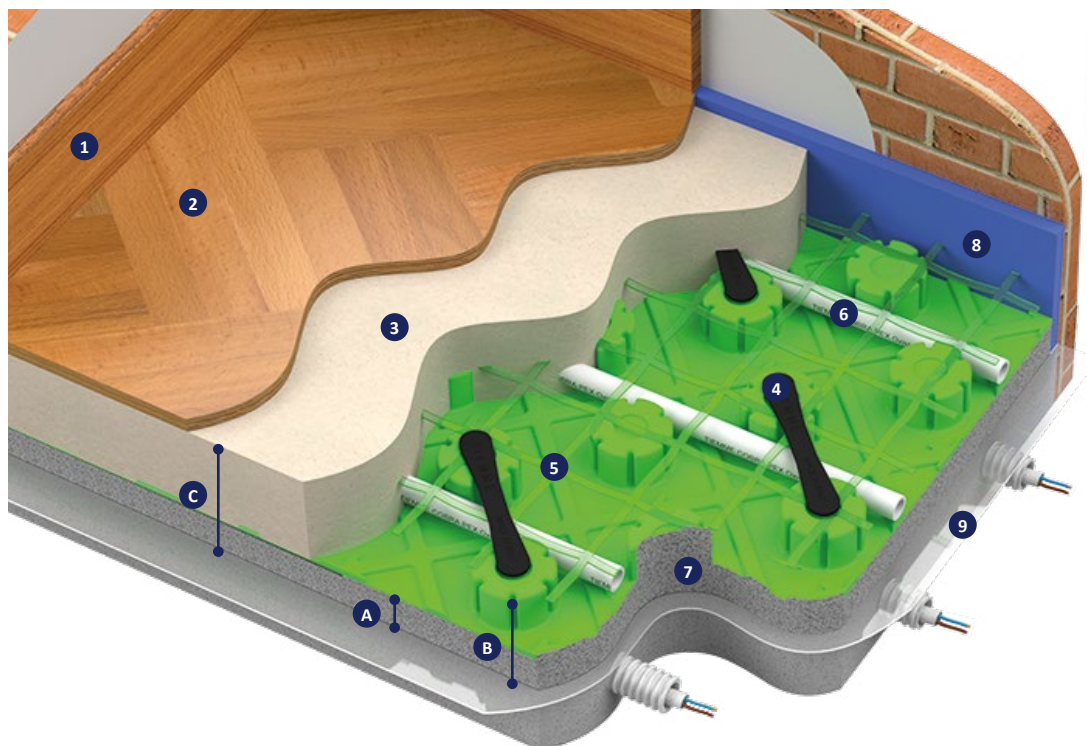

- | | |
|-------------------------------|-------------------------|
| 1. Plinta | - |
| 2. Pardoseala | - |
| 3. Sapa speciala | - |
| 4. Colier pentru fixarea tevi | art. 4527 |
| 5. Plasa in fibra de sticla | art. 4532 |
| 6. Tub | art. 0200B |
| 7. Panou izolant | art. 4500/4500N/4524GRF |
| 8. Banda perimetrala | art. 4507 |
| 9. Folie PE | art. 4503 |

Cod	Dimensiune (mm)		
	A	B	C
450 0005 450 0769	20	40	70 ÷ 80
450 0721	23	47	73 ÷ 83
450 0722	38	62	88 ÷ 98
450 0725	45	69	95 ÷ 105
450 0726	60	84	110 ÷ 120

GROSIMI CONFORME CU UNI EN 1264

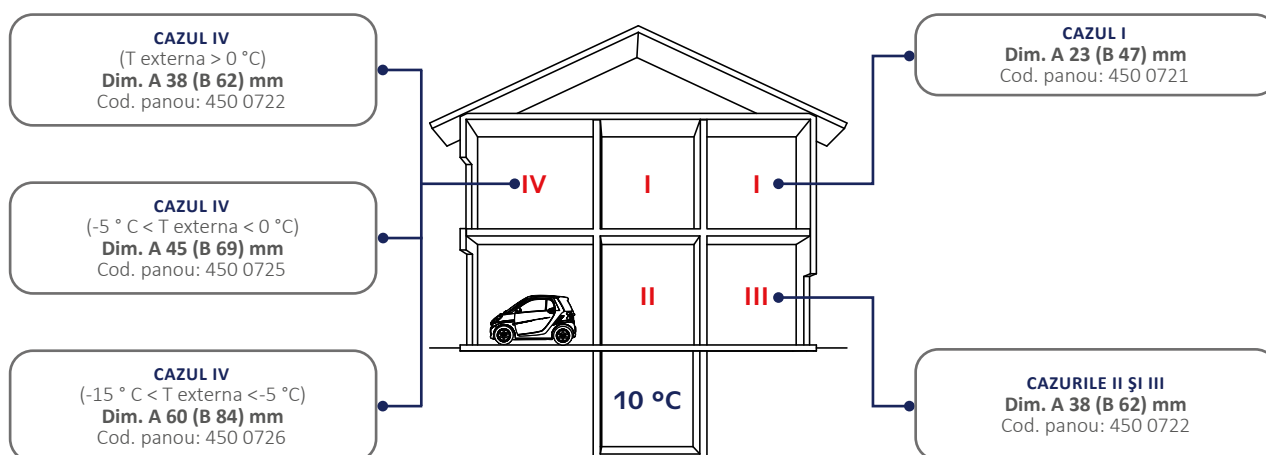

13A NEW CLASSIC ȘI NEW CLASSIC GRAPHITE

PANOUL IZOLANT

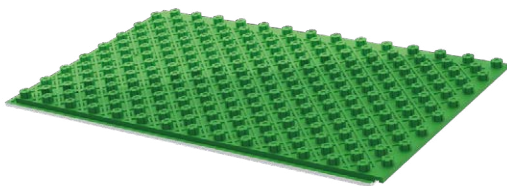

4500

Panoul izolant din polistiren expandat sinterizat respecta normele UNI EN 13163. Nuturile de pe suprafata panoului rezultate in urma termoformarii permit montajul tubului la un pas minim de 50mm, iar imbinarea tip nut si feder asigura o fixare sigura intre panouri.

Cod	Grosime izolant (mm)	R.C. 10% (kPa)	Pret €/m ²	Ambalare (m ²)	N° Panouri Pentru ambal.
450 0005	20	200		17,92/71,68	16

Până la terminarea stocului

NOUJATAI



4500N

Panoul izolant din polistiren expandat sinterizat respecta normele UNI EN 13163. Nuturile de pe suprafata panoului rezultate in urma termoformarii permit montajul tubului la un pas minim de 50mm, iar imbinarea tip nut si feder asigura o fixare sigura intre panouri.

Cod	Grosime izolant (mm)	R.C. 10% (kPa)	Pret €/m ²	Ambalare (m ²)	N° Panouri Pentru ambal.
450 0769	20	200		17,92/71,68	16

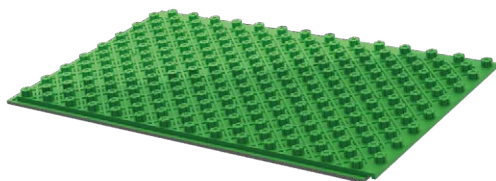

4524GRF

Panoul izolant din polistiren expandat sinterizat cu grafit respecta normele UNI EN 13163. Nuturile de pe suprafata panoului rezultate in urma termoformarii permit montajul tubului la un pas minim de 50mm, iar imbinarea tip nut si feder asigura o fixare sigura intre panouri.
Grosimi disponibile conforme prevederilor normelor UNI EN 1264:2021

Cod	Grosime izolant (mm)	R.C. 10% (kPa)	Pret €/m ²	Ambalare (m ²)	N° Panouri Pentru ambal.
450 0721	23	150		15,68/62,72	14
450 0722	38	150		11,20/44,80	10
450 0725	45	150		8,96/35,84	8
450 0726	60	150		7,84/31,36	7

La cerere

CARACTERISTICI TEHNICE

	Cod				
	450 0005 450 0769	450 0721	450 0722	450 0725	450 0726
Rezistenta termica EN 13163 (m ² k/W)	0,61	0,75	1,25	1,50	2,00
Rezistenta la compresie la 10% UNI EN 826 (kPa)	200	150			
Grosime izolatie (mm)	20	23	38	45	60
Grosime totala (mm)	40	47	62	69	84
Pellicula de plastic (μm)	160				
Pas minim de asezare (mm)	50				
Conductibilitatea termica UNI EN 12667 (W/mk)	0,033	0,030			
Absorbtia apei UNI EN 12087 (%)	<5	4			
Reactie la foc EN 13501-1 (Euroclasa)	E				
Dimensiune totala panou (mm)	1425 x 825	1425 x 825			
Dimensiune utila panou (mm)	1400 x 800	1400 x 800			
Suprafata utila a panoului (m ²)	1,12	1,12			
Numar panouri in ambalaj (n)	16	14	10	8	7
Suprafata panou in ambalaj (m ²)	17,92	15,68	11,20	8,96	7,84

Soluție ideală pentru sistemele de încălzire și răcire rezidențiale și comerciale. Panoul cu nuturi termoformat permite obținerea chiar și de grosimi mici și, prin urmare, este potrivit și pentru renovări.

Protecție maximă împotriva punților termice. Pas de instalare 50 mm și multipli. Cuplarea dintre panouri este garantată prin suprapunerea nuturilor laterale.

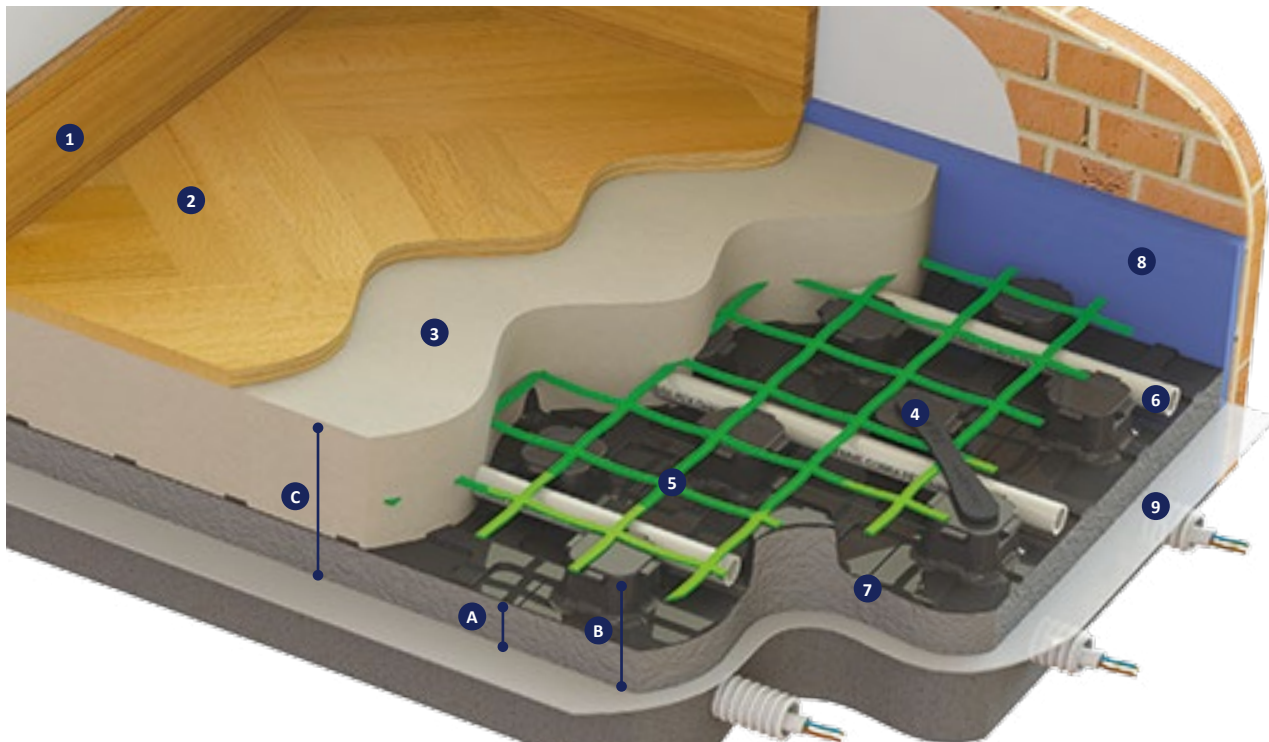

- | | |
|--------------------------------|-----------------|
| 1. Plinta | - |
| 2. Pardoseala | - |
| 3. Sapa speciala | - |
| 4. Colier pentru fixarea tevii | art. 4527 |
| 5. Plasa in fibra de sticla | art. 4532 |
| 6. Tub | art. 0200B |
| 7. Panou izolant | art. 4528PANGRF |
| 8. Banda perimetrala | art. 4507 |
| 9. Folie PE | art. 4503 |

Cod	Dimensiune (mm)		
	A	B	C
450 0729	10	32	60 ÷ 70
450 0730	23	45	73 ÷ 85
450 0731	38	60	88 ÷ 98
450 0732	45	67	95 ÷ 105
450 0733	60	82	110 ÷ 120

GROSIMI CONFORME CU UNI EN 1264

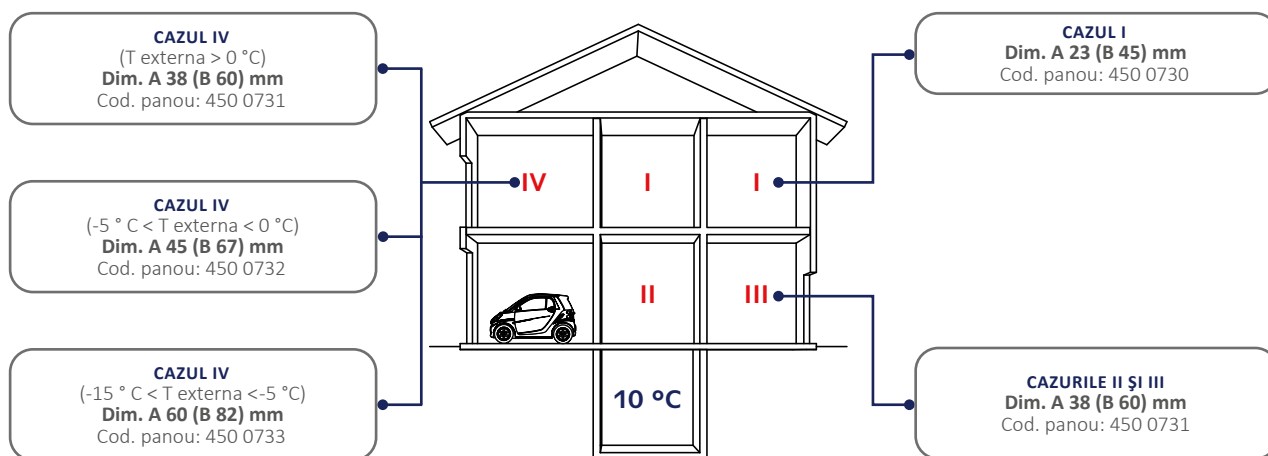



4528PANGRF

Placa cu nuturi termoformată din polistiren expandat sinterizat cu grafit și acoperită cu o peliculă de plastic de culoare neagră. Realizat conform normei EN 13163, pelicula de plastic are o structură solidă ce a permis realizarea unor canturi laterale pe corpul nuturilor, obținându-se astfel o fixare mai stabilă a tubului (pas 50mm). Folia rigidă din plastic de culoare neagră îmbunătățește rezistența panoului în timpul montajului. Profilele nuturilor laterale de tip mama-tata asigură o etanșeizare îmbunătățită, fapt ce permite și posibilitatea de utilizare a șapelor auto-nivelante.

Grosimi disponibile conforme prevederilor normelor UNI EN 1264:2021

Cod	Grosime izolant (mm)	R.C. 10% (kPa)	Pret €/m ²	Ambalare (m ²)	N° Panouri Pentru ambal.
450 0729	10	200		20,16/100,8	18
450 0730	23	150		12,32/61,60	11
450 0731	38	150		8,96/44,80	8
450 0732	45	150		7,84/39,20	7
450 0733	60	150		5,60/28,00	5

CARACTERISTICI TEHNICE

	Cod				
	450 0729	450 0730	450 0731	450 0732	450 0733
Rezistența termică EN 13163 (m ² k/W)	0,33	0,75	1,25	1,50	2,00
Rezistența la compresie la 10% UNI EN 826 (kPa)	200	150			
Grosime izolație (mm)	10	23	38	45	60
Grosime totală (mm)	32	45	60	67	82
Placă rigidă de acoperire (mm)	0,6				
Pas minim de așezare (mm)	50				
Conductibilitatea termică UNI EN 12667 (W/mk)	0,030				
Absorbția apei UNI EN 12087 (%)	6,5	4,0			
Reacție la foc EN 13501-1 (Euroclasa)	E				
Dimensiune totală panou (mm)	1450 X 850				
Dimensiune utilă panou (mm)	1400 X 800				
Suprafața utilă a panoului (m ²)	1,12				
Număr panouri în ambalaj (n)	18	11	8	7	5
Suprafața panou în ambalaj (m ²)	20,16	12,32	8,96	7,84	5,60

Soluție ideală pentru sistemele de încălzire și răcire rezidențiale și comerciale. Panoul cu nuturi termoformat permite obținerea chiar și de grosimi mici și, prin urmare, este potrivit și pentru renovări.

Protecție maximă împotriva punctilor termice. Pas de instalare 50 mm și multipli. Cuplarea dintre panouri este garantată prin suprapunerea nuturilor laterale.

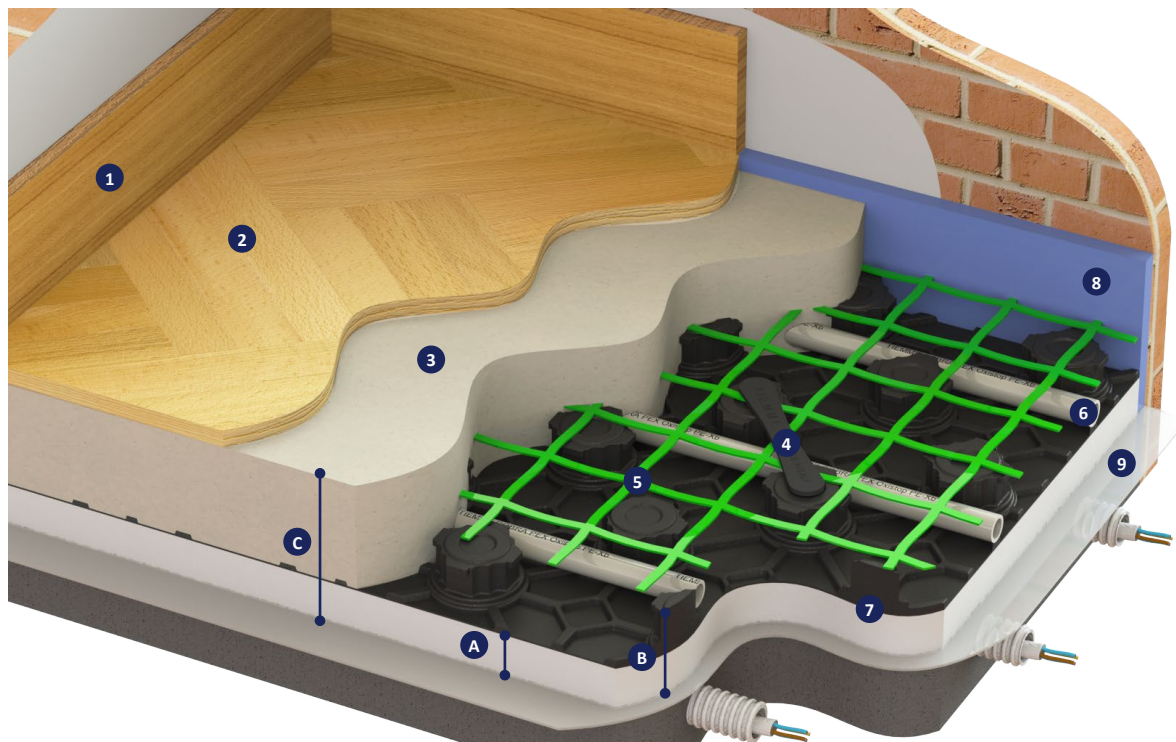

- | | |
|--------------------------------|---------------------|
| 1. Plinta | - |
| 2. Pardoseala | - |
| 3. Sapa speciala | - |
| 4. Colier pentru fixarea tevii | art. 4527 |
| 5. Plasa in fibra de sticla | art. 4532 |
| 6. Tub | art. 0200B |
| 7. Panou izolant | art. 4501PAN |
| 8. Banda perimetrala | art. 4507 |
| 9. Folie PE | art. 4503 |

Cod	Dimensiune (mm)		
	A	B	C
450 0570	10	32	60 ÷ 70
450 0531	20	42	70 ÷ 80
450 0532	30	52	80 ÷ 90
450 0687	40	62	90 ÷ 100



4501PAN

Placa cu nuturi termoformata din polistiren expandat sinterizat si acoperita cu o pelicula de plastic de culoare neagra. Realizat conform normei EN 13163, pelicula de plastic are o structura solida ce a permis realizarea unor canturi laterale pe corpul nuturilor, obtinandu-se astfel o fixare mai stabila a tubului (pas 50mm). Folia rigida din plastic de culoare neagra imbunatateste rezistenta panoului in timpul montajului. Profilele nuturilor laterale de tip mama-tata asigura o etanseizare imbunătățită, fapt ce permite si posibilitatea de utilizare a saepelor auto-nivelante.

Cod	Grosime izolant (mm)	R.C. 10% (kPa)	Pret €/m ²	Ambalare (m ²)	N° Panouri Pentru ambal.
450 0570	10	150		20,16/100,8	18
450 0531	20	150		13,44/67,2	12
450 0532	30	150		11,2/56	10
450 0687	40	150		8,96/44,8	8

CARACTERISTICI TEHNICE

	Cod			
	450 0570	450 0531	450 0532	450 0687
Rezistenta termica EN 13163 (m ² k/W)	0,29	0,59	0,88	1,18
Rezistenta la compresie la 10% UNI EN 826 (kPa)	150			
Grosime izolatie (mm)	10	20	30	40
Grosime totala (mm)	32	42	52	62
Placă rigidă de acoperire (mm)	0,5			
Pas minim de asezare (mm)	50			
Conductibilitatea termica UNI EN 12667 (W/mk)	0,034			
Absorbția apei UNI EN 12087 (%)	0,5			
Reactie la foc EN 13501-1 (Euroclasa)	E			
Dimensiune totala panou (mm)	1450 X 850			
Dimensiune utila panou (mm)	1400 X 800			
Suprafata utila a panoului (m ²)	1,12			
Numar panouri in ambalaj (n)	18	12	10	8
Suprafata panou in ambalaj (m ²)	20,16	13,44	11,20	8,96



0200B

Tub din polietilena reticulata de inalta densitate **COBRAPEX** cu bariera oxigen (EVOH). Culoare alba

CARACTERISTICI TEHNICE

- Temperatura maxima de lucru: 95°C
- Conductivitate termică: 0,38 W/mk
- Conform EN ISO 15875-2
- Bariera de oxigen EVOH conformă cu DIN 4726
- Compozitie: PE-Xb

Cod	Dimensiune	Pret €/m	Ambalare (m)
020 0005	16 x 2,0		120/3240
020 0018	16 x 2,0		200/3600
020 0003	16 x 2,0		300/3600
020 0001	16 x 2,0		600/3000
020 0008	17 x 2,0		120/3240
020 0071	17 x 2,0		200/3200
020 0006	17 x 2,0		300/2400
020 0002	17 x 2,0		600/3000



0200R

Tub din polietilena reticulata de inalta densitate **COBRAPERT** cu bariera oxigen (EVOH). Culoare rosie

i De culoare tub ■

Cod	Dimensiune	Pret €/m	Ambalare (m)
020 0074	16 x 2,0		300/2700
020 0090	16 x 2,0		600/3000
020 0128	17 x 2,0		600/3000



0210R

Tub din polietilena rezistenta la temperaturi ridicate **COBRAPERTE** cu bariera oxigen (EVOH). Culoare rosie.

CARACTERISTICI TEHNICE

- Temperatura maxima de lucru: 70°C
- Conductivitate termică: 0,40 W/mk
- Conform EN ISO 22391
- Bariera de oxigen EVOH conformă cu DIN 4726
- Compozitie: PE-RT

i De culoare tub ■

Cod	Dimensiune	Pret €/m	Ambalare (m)
021 0004	16 x 2,0		300/2700
021 0003	16 x 2,0		600/3000
021 0013	17 x 2,0		120/3840
021 0011	17 x 2,0		300/2400
021 0005	17 x 2,0		600/3000



4507

Banda perimetrala din PE expandat cu partea posterioara complet adeziva si folie din PE.

i Pretaiata H=100mm

Cod	Dimensiune	Pret €/m	Ambalare (m)
450 0443	H 150 x 5 mm		50/250
450 0007	H 150 x 8 mm		25/125



1480P

Curba conductoare la 90° din plastic pentru protectia si sustinerea tubului „COBRAPEX” in apropierea racordului la colectorul de distributie

Cod	Dimensiune	Pret €	Ambalare
034 0077	tub Ø 16 - 18		25/500



4527

Colier de fixare pe panou a tubului si/sau plasei zincate de prindere. Realizat din plastic si prevazut cu aripioare de fixare

Cod	Dimensiune (mm)	Pret €	Ambalare
450 0018	H = 28		100/1000



4540

Aditiv pentru sapa în solutie apoasa compus din polimeri acrilici; reduce contractiile higroscopice reducand rezistenta termica si îmbunatatind conductivitatea.

CARACTERISTICI TEHNICE

- Dozaj: 1kg aditiv x 100 kg ciment

Cod	Dimensiune	Pret €/kg	Ambalare (kg)
450 0019	10 Kg ≈ 9,6 l		10/10
450 0017	25 Kg ≈ 24 l		25/25



LISTA DE PREȚURI



4508

Profil de dilatare din PE cu suport autoadeziv.

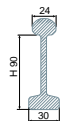

CARACTERISTICI TEHNICE

- Înălțime: 90 mm
- Lungime: 2m

Cod	Dimensiune	Pret €/m	Ambalare (m)
450 0023	-		20/180



4503

Folie PE cu rol de izolație și bariera împotriva umidității.

CARACTERISTICI TEHNICE

- Latime: 1,2 m
- Lungime: 100 m
- Grosime: 0,15 mm

Cod	Dimensiune	Pret €/m ²	Ambalare (m ²)
450 0025	-		120/120

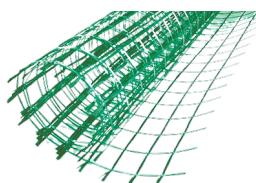

4532

Plasă din fibra de sticlă tratată antialkalin pentru armarea sașurilor de ciment.

CARACTERISTICI TEHNICE

- Dimensiunea ochiului: 40 x 40 mm
- Greutate: 130 g/m²

i La cerere și plasă de sârmă de 2 mm.

Cod	Dimensiune	Pret €/m ²	Ambalare (m ²)
450 0152	1 m x 50 m		50/800
450 0022	1 m x 100 m		100/800



4539

Soluție protectivă contra coroziunii, în particular metalice cu Fungicid antibacterian universal pentru sisteme de încălzire și răcire

CARACTERISTICI TEHNICE

- Dozare: 1 l aditiv x 100 l apă

Cod	Dimensiune	Pret €	Ambalare
450 0486	1 l		1/12



4535

Pompa de incercare a instalatiilor la presiune, cu racord de 1/2\".

i Capacitate rezervor 8 l

Cod	Dimensiune	Pret €	Ambalare
450 0049	50 bar		1



4530

Dispozitiv de desfasurat tubul (pana la 20)

Cod	Dimensiune	Pret €	Ambalare
450 0028	-		1



1495

Foarfecă pentru tuburi

Cod	Dimensiune	Pret €	Ambalare
034 0015	∅ 0 - 35		50/200



4522

Masina de uscat sapa

Cod	Dimensiune	Pret €	Ambalare
450 0020	230 Vac 2,5 KW		1/1



4522A

Adaptor 380VAC-230VAC pentru masina de uscat sapa

Cod	Dimensiune	Pret €	Ambalare
450 0381	230 - 380 Vac		1/5



13_B SET COLECTOARE "FLOOR" DIN ALAMA STANTATA 1"

Pentru utilizare cu caseta 1939 (pag. 294)



3873J

Colector de distribuție de 1" cu debitmetre

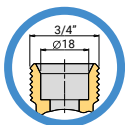

Cod	Dimensiune	Cai	Pret €	Ambalare
385 0106	1"G	2		1/1
385 0107	1"G	3		1/1
385 0108	1"G	4		1/1
385 0109	1"G	5		1/1
385 0110	1"G	6		1/1
385 0111	1"G	7		1/1
385 0112	1"G	8		1/1
385 0113	1"G	9		1/1
385 0114	1"G	10		1/1
385 0115	1"G	11		1/1
385 0116	1"G	12		1/1



3878

Colector de distribuție de 1" cu memorie mecanică

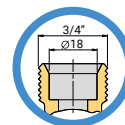

Cod	Dimensiune	Cai	Pret €	Ambalare
385 0040	1"G	2		1/1
385 0042	1"G	3		1/1
385 0035	1"G	4		1/1
385 0030	1"G	5		1/1
385 0028	1"G	6		1/1
385 0044	1"G	7		1/1
385 0031	1"G	8		1/1
385 0065	1"G	9		1/1
385 0058	1"G	10		1/1
385 0057	1"G	11		1/1
385 0060	1"G	12		1/1



3873BYD

Colector de distribuție de 1" cu by-pass diferential și debitmetre



Cu by-pass diferential

Cod	Dimensiune	Cai	Pret €	Ambalare
385 0062	1"G	2		1/1
385 0061	1"G	3		1/1
385 0043	1"G	4		1/1
385 0026	1"G	5		1/1
385 0001	1"G	6		1/1
385 0004	1"G	7		1/1
385 0008	1"G	8		1/1
385 0013	1"G	9		1/1
385 0006	1"G	10		1/1
385 0021	1"G	11		1/1
385 0007	1"G	12		1/1
385 0120	1"G	13		1/1
385 0121	1"G	14		1/1



3878BYD

Colector de distribuție de 1" cu by-pass diferential și memorie mecanică



Cu by-pass diferential

Cod	Dimensiune	Cai	Pret €	Ambalare
385 0068	1"G	2		1/1
385 0069	1"G	3		1/1
385 0067	1"G	4		1/1
385 0064	1"G	5		1/1
385 0052	1"G	6		1/1
385 0066	1"G	7		1/1
385 0033	1"G	8		1/1
385 0055	1"G	9		1/1
385 0051	1"G	10		1/1
385 0050	1"G	11		1/1
385 0056	1"G	12		1/1

13_B SET COLECTOARE "FLOOR" DIN ALAMA STANTATA 1"

Pentru utilizare cu caseta 1940 (pag. 294)



3873RJ

Colector de distribuție de 1" cu debitmetre și izolație

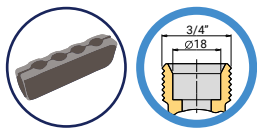

Cod	Dimensiune	Cai	Pret €	Ambalare
557 0546	1"G	2		1/1
557 0547	1"G	3		1/1
557 0548	1"G	4		1/1
557 0549	1"G	5		1/1
557 0550	1"G	6		1/1
557 0551	1"G	7		1/1
557 0552	1"G	8		1/1
557 0553	1"G	9		1/1
557 0554	1"G	10		1/1
557 0555	1"G	11		1/1
557 0556	1"G	12		1/1



3878R

Colector de distribuție de 1" cu memorie mecanică și izolație

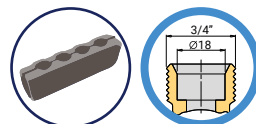

Cod	Dimensiune	Cai	Pret €	Ambalare
557 0051	1"G	2		1/1
557 0052	1"G	3		1/1
557 0053	1"G	4		1/1
557 0054	1"G	5		1/1
557 0055	1"G	6		1/1
557 0056	1"G	7		1/1
557 0057	1"G	8		1/1
557 0058	1"G	9		1/1
557 0059	1"G	10		1/1
557 0060	1"G	11		1/1
557 0061	1"G	12		1/1



3873RBYDJ

Colector de distribuție de 1" cu by-pass diferential debitmetre și izolație



Cu by-pass diferential

Cod	Dimensiune	Cai	Pret €	Ambalare
557 0653	1"G	2		1/1
557 0654	1"G	3		1/1
557 0655	1"G	4		1/1
557 0656	1"G	5		1/1
557 0657	1"G	6		1/1
557 0658	1"G	7		1/1
557 0659	1"G	8		1/1
557 0660	1"G	9		1/1
557 0661	1"G	10		1/1
557 0662	1"G	11		1/1
557 0663	1"G	12		1/1
557 0670	1"G	13		1/1
557 0671	1"G	14		1/1



3878RBYD

Colector de distribuție de 1" cu by-pass diferential memorie mecanică și izolație



Cu by-pass diferential

Cod	Dimensiune	Cai	Pret €	Ambalare
557 0062	1"G	2		1/1
557 0063	1"G	3		1/1
557 0064	1"G	4		1/1
557 0065	1"G	5		1/1
557 0066	1"G	6		1/1
557 0067	1"G	7		1/1
557 0068	1"G	8		1/1
557 0069	1"G	9		1/1
557 0070	1"G	10		1/1
557 0071	1"G	11		1/1
557 0072	1"G	12		1/1



13_B SET COLECTOARE "FLOOR" DIN ALAMA STANTATA 1" 1/4

Pentru utilizare cu caseta 1940 (pag. 294)



3877

Colector de distribuție de 1" 1/4 cu debitmetre

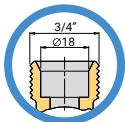

Cod	Dimensiune	Cai	Pret €	Ambalare
385 0122	1" 1/4G	2		1/1
385 0123	1" 1/4G	3		1/1
385 0124	1" 1/4G	4		1/1
385 0125	1" 1/4G	5		1/1
385 0126	1" 1/4G	6		1/1
385 0127	1" 1/4G	7		1/1
385 0128	1" 1/4G	8		1/1
385 0129	1" 1/4G	9		1/1
385 0130	1" 1/4G	10		1/1
385 0131	1" 1/4G	11		1/1
385 0132	1" 1/4G	12		1/1



3879

Colector de distribuție de 1" 1/4 cu memorie mecanică

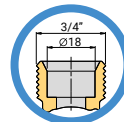

Cod	Dimensiune	Cai	Pret €	Ambalare
385 0144	1" 1/4G	2		1/1
385 0145	1" 1/4G	3		1/1
385 0146	1" 1/4G	4		1/1
385 0147	1" 1/4G	5		1/1
385 0148	1" 1/4G	6		1/1
385 0149	1" 1/4G	7		1/1
385 0150	1" 1/4G	8		1/1
385 0151	1" 1/4G	9		1/1
385 0152	1" 1/4G	10		1/1
385 0153	1" 1/4G	11		1/1
385 0154	1" 1/4G	12		1/1



3877BYD

Colector de distribuție de 1" 1/4 cu by-pass diferential și debitmetre



Cu by-pass diferential

Cod	Dimensiune	Cai	Pret €	Ambalare
385 0133	1" 1/4G	2		1/1
385 0134	1" 1/4G	3		1/1
385 0135	1" 1/4G	4		1/1
385 0136	1" 1/4G	5		1/1
385 0137	1" 1/4G	6		1/1
385 0138	1" 1/4G	7		1/1
385 0139	1" 1/4G	8		1/1
385 0140	1" 1/4G	9		1/1
385 0141	1" 1/4G	10		1/1
385 0142	1" 1/4G	11		1/1
385 0143	1" 1/4G	12		1/1



3879BYD

Colector de distribuție de 1" 1/4 cu by-pass diferential și memorie mecanică



Cu by-pass diferential

Cod	Dimensiune	Cai	Pret €	Ambalare
385 0155	1" 1/4G	2		1/1
385 0156	1" 1/4G	3		1/1
385 0157	1" 1/4G	4		1/1
385 0158	1" 1/4G	5		1/1
385 0159	1" 1/4G	6		1/1
385 0160	1" 1/4G	7		1/1
385 0161	1" 1/4G	8		1/1
385 0162	1" 1/4G	9		1/1
385 0163	1" 1/4G	10		1/1
385 0164	1" 1/4G	11		1/1
385 0165	1" 1/4G	12		1/1

13_B SET COLECTOARE "FLOOR" DIN ALAMA STANTATA 1" 1/4

Pentru utilizare cu caseta 1940 (pag. 294)

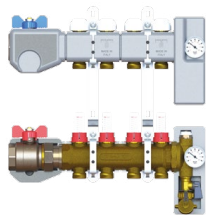

3877R

Colector de distribuție izolat 1" 1/4 cu debitmetre

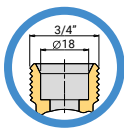

Cod	Dimensiune	Cai	Pret €	Ambalare
557 0571	1" 1/4G	2		1/1
557 0572	1" 1/4G	3		1/1
557 0573	1" 1/4G	4		1/1
557 0574	1" 1/4G	5		1/1
557 0575	1" 1/4G	6		1/1
557 0576	1" 1/4G	7		1/1
557 0577	1" 1/4G	8		1/1
557 0578	1" 1/4G	9		1/1
557 0579	1" 1/4G	10		1/1
557 0580	1" 1/4G	11		1/1
557 0581	1" 1/4G	12		1/1

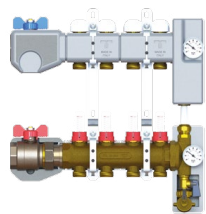

3877RBYD

Colector de distribuție izolat de 1" 1/4 cu by-pass diferential și debitmetre

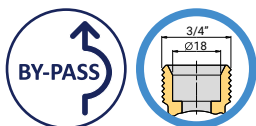

Cu by-pass diferential

Cod	Dimensiune	Cai	Pret €	Ambalare
557 0582	1" 1/4G	2		1/1
557 0583	1" 1/4G	3		1/1
557 0584	1" 1/4G	4		1/1
557 0585	1" 1/4G	5		1/1
557 0586	1" 1/4G	6		1/1
557 0587	1" 1/4G	7		1/1
557 0588	1" 1/4G	8		1/1
557 0589	1" 1/4G	9		1/1
557 0590	1" 1/4G	10		1/1
557 0591	1" 1/4G	11		1/1
557 0592	1" 1/4G	12		1/1

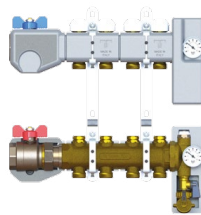

3879R

Colector de distribuție izolat de 1" 1/4 cu memorie mecanică

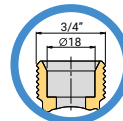

Cod	Dimensiune	Cai	Pret €	Ambalare
557 0561	1" 1/4G	2		1/1
557 0562	1" 1/4G	3		1/1
557 0563	1" 1/4G	4		1/1
557 0564	1" 1/4G	5		1/1
557 0565	1" 1/4G	6		1/1

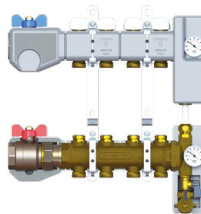

3879RBYD

Colector de distribuție izolat de 1" 1/4 cu by-pass diferential și memorie mecanică



Cu by-pass diferential

Cod	Dimensiune	Cai	Pret €	Ambalare
557 0566	1" 1/4G	2		1/1
557 0567	1" 1/4G	3		1/1
557 0568	1" 1/4G	4		1/1
557 0569	1" 1/4G	5		1/1
557 0570	1" 1/4G	6		1/1



13_B SET COLECTOARE "FLOOR" DIN ALAMA STANTATA CU FILET FAZAT 1"

Pentru utilizare cu caseta 1939 (pag. 294)



3049

Colector de distributie cu filet fazat de 1" cu iesiri 3/4"x18 (Eurocono) si indicatoare de debit

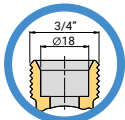

Cod	Dimensiune	Cai	Pret €	Ambalare
385 0047	1"G	2		1/1
385 0039	1"G	3		1/1
385 0032	1"G	4		1/1
385 0016	1"G	5		1/1
385 0003	1"G	6		1/1
385 0012	1"G	7		1/1
385 0019	1"G	8		1/1
385 0025	1"G	9		1/1
385 0037	1"G	10		1/1
385 0053	1"G	11		1/1
385 0046	1"G	12		1/1
385 0070	1"G	13		1/1
385 0071	1"G	14		1/1



3050

Colector de distributie cu filet fazat de 1" cu iesiri 3/4"x18 (Eurocono) si vane cu memorie mecanica

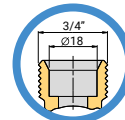

Cod	Dimensiune	Cai	Pret €	Ambalare
385 0059	1"G	2		1/1
385 0054	1"G	3		1/1
385 0034	1"G	4		1/1
385 0038	1"G	5		1/1
385 0017	1"G	6		1/1
385 0018	1"G	7		1/1
385 0023	1"G	8		1/1
385 0024	1"G	9		1/1
385 0027	1"G	10		1/1
385 0048	1"G	11		1/1
385 0049	1"G	12		1/1
385 0072	1"G	13		1/1
385 0073	1"G	14		1/1



3049I

Colector de distributie cu filet fazat de 1" cu iesiri 3/4"x18 (Eurocono) si indicatoare de debit

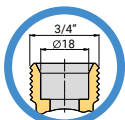

i Debitmetre instalate pe partea superioară a kitului

Cod	Dimensiune	Cai	Pret €	Ambalare
385 0084	1"G	2		1/1
385 0085	1"G	3		1/1
385 0086	1"G	4		1/1
385 0087	1"G	5		1/1
385 0088	1"G	6		1/1
385 0089	1"G	7		1/1
385 0090	1"G	8		1/1
385 0091	1"G	9		1/1
385 0092	1"G	10		1/1
385 0093	1"G	11		1/1
385 0094	1"G	12		1/1



3050I

Colector de distributie cu filet fazat de 1" cu iesiri 3/4"x18 (Eurocono) si vane cu memorie mecanica

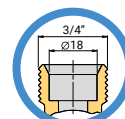

i Ventilele cu memorie mecanica instalate pe partea superioară a kitului

Cod	Dimensiune	Cai	Pret €	Ambalare
385 0095	1"G	2		1/1
385 0096	1"G	3		1/1
385 0097	1"G	4		1/1
385 0098	1"G	5		1/1
385 0099	1"G	6		1/1
385 0100	1"G	7		1/1
385 0101	1"G	8		1/1
385 0102	1"G	9		1/1
385 0103	1"G	10		1/1
385 0104	1"G	11		1/1
385 0105	1"G	12		1/1

13_B SET COLECTOARE "FLOOR" DIN ALAMA STANTATA 1"



3049KIT01

Kit terminal pentru colectoare "FLOOR"

Cod	Dimensiune	Pret €	Ambalare
385 0005	1"		1/5
385 0266	1"1/4		1/5



3049KIT01J

Kit terminal pentru colectoare "FLOOR"

Cod	Dimensiune	Pret €	Ambalare
385 0117	1"		1/5
385 0281	1"1/4		1/5



3049KIT02D

Kit terminal cu by-pass diferential pentru colectoare "FLOOR"

Cu by-pass diferential

Cod	Dimensiune	Pret €	Ambalare
385 0285	1"		1/8
385 0286	1"1/4		1/5



3049KIT02JD

Kit terminal cu by-pass diferential pentru colectoare "FLOOR"

Cu by-pass diferential

Cod	Dimensiune	Pret €	Ambalare
385 0282	1"		1/8

EXEMPLU DE INSTALARE

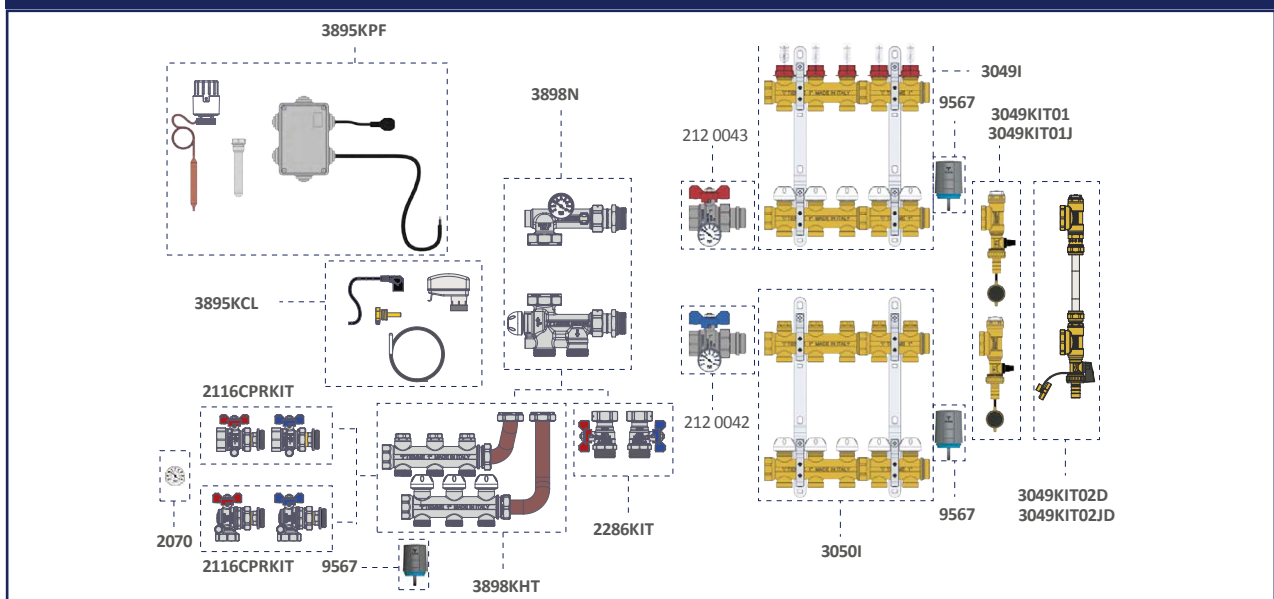

13_B SET COLECTOARE BARA DIN ALAMA - 1"

Pentru utilizare cu caseta 1939 (pag. 294)



3856N

Colector de distribuție de 1" cu debitmetre

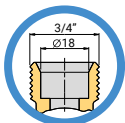

Cod	Dimensiune	Cai	Pret €	Ambalare
387 0309	1"G	3		1/1
387 0202	1"G	4		1/1
387 0311	1"G	5		1/1
387 0307	1"G	6		1/1
387 0312	1"G	7		1/1
387 0308	1"G	8		1/1
387 0313	1"G	9		1/1
387 0314	1"G	10		1/1
387 0315	1"G	11		1/1
387 0310	1"G	12		1/1



3866N

Colector de distribuție de 1" cu memorie mecanică

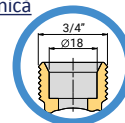

Cod	Dimensiune	Cai	Pret €	Ambalare
387 0271	1"G	3		1/1
387 0303	1"G	4		1/1
387 0263	1"G	5		1/1
387 0264	1"G	6		1/1
387 0265	1"G	7		1/1
387 0266	1"G	8		1/1
387 0267	1"G	9		1/1
387 0268	1"G	10		1/1
387 0269	1"G	11		1/1
387 0270	1"G	12		1/1

13_B SET COLECTOARE BARA DIN ALAMA - 1"



3891N

Kit terminal pentru colectoare
3856X - 3866X - 3856N - 3866N

Cod	Dimensiune	Pret €	Ambalare
450 0441	1"		1/10



3891NJ

Kit terminal pentru colectoare

Cod	Dimensiune	Pret €	Ambalare
450 0484	1"		1/5



3891NBY

Kit terminal cu by-pass pentru
colectoare 3856X - 3866X -
3856N - 3866N

Cod	Dimensiune	Pret €	Ambalare
450 0442	1"		1/10



3891NBYD

Kit terminal cu by-pass
diferential pentru colectoare
3855X-3856X-3865X-3866X

Cod	Dimensiune	Pret €	Ambalare
385 0301	1"		1/10



3891NBYJ

Kit terminal cu by-pass pentru
colectoare

Cod	Dimensiune	Pret €	Ambalare
450 0485	1"		1/8

GHID DE ACCESORII

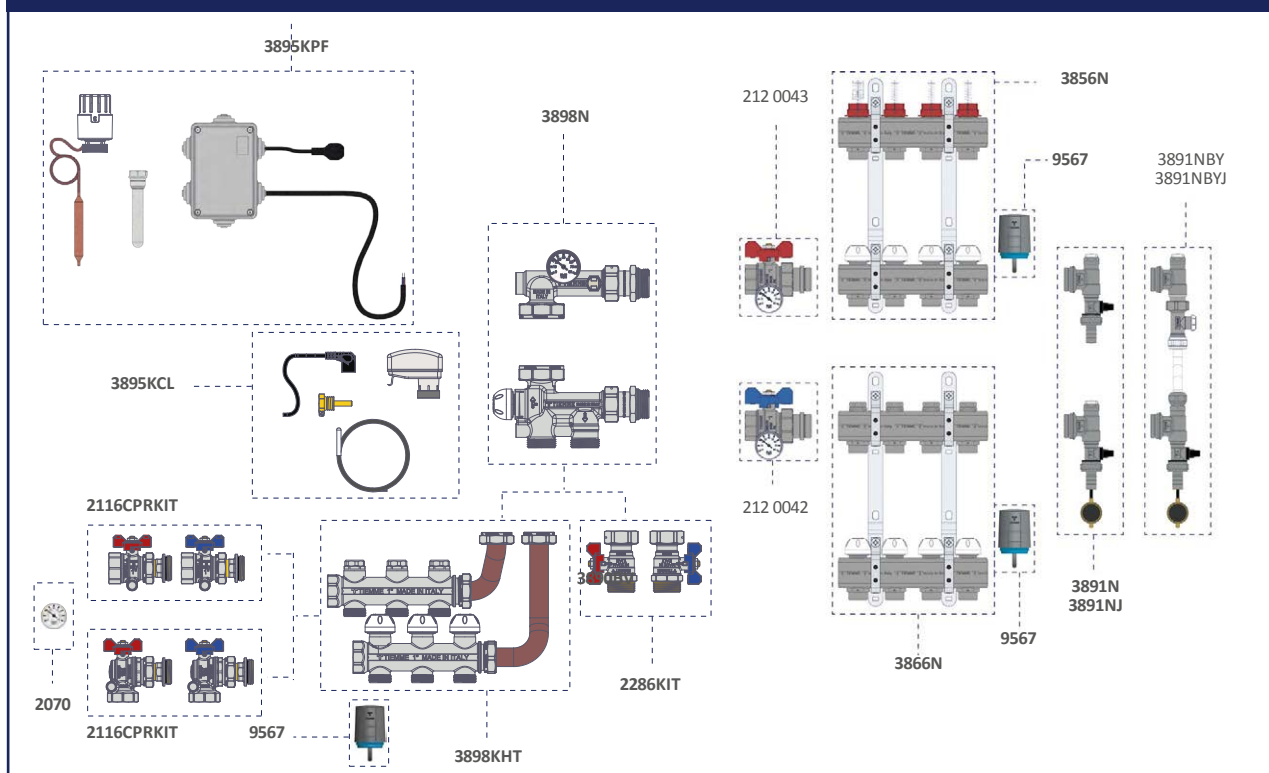

13_B SET COLECTOARE DIN OTEL-INOX AISI 304L - 1"

Pentru utilizare cu caseta 1939 (pag. 294)

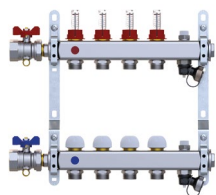

3871XT

Colector de distributie de 1" din otel inox AISI 304L cu iesiri 3/4"x18 (Eurocono) si indicatoare de debit.

Cod	Dimensiune	Cai	Pret €	Ambalare
387 0349	1"G	2		1/1
387 0350	1"G	3		1/1
387 0351	1"G	4		1/1
387 0352	1"G	5		1/1
387 0353	1"G	6		1/1
387 0354	1"G	7		1/1
387 0355	1"G	8		1/1
387 0356	1"G	9		1/1
387 0357	1"G	10		1/1
387 0358	1"G	11		1/1
387 0359	1"G	12		1/1

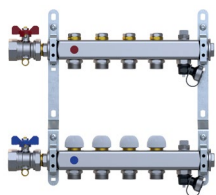

3875XT

Colector de distributie de 1" din otel inox AISI 304L cu iesiri 3/4"x18 (Eurocono) si vane cu memorie mecanica.

Cod	Dimensiune	Cai	Pret €	Ambalare
387 0360	1"G	2		1/1
387 0361	1"G	3		1/1
387 0362	1"G	4		1/1
387 0363	1"G	5		1/1
387 0364	1"G	6		1/1
387 0365	1"G	7		1/1
387 0366	1"G	8		1/1
387 0367	1"G	9		1/1
387 0368	1"G	10		1/1
387 0369	1"G	11		1/1
387 0370	1"G	12		1/1



2070

Termometru Ø 40 L=30 mm
scara 0 ÷ 80°C

Cod	Dimensiune	Pret €	Ambalare
179 0006	-		10/50

13_B SET COLECTOARE DIN OTEL-INOX AISI 304L - 1"

Pentru utilizare cu caseta 1939 (pag. 294)

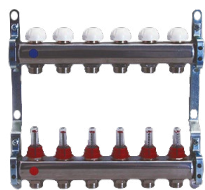

3856X

Colector de distributie de 1" din oțel inox AISI 304L cu iesiri 3/4"x18 (Eurocono) și indicatoare de debit.

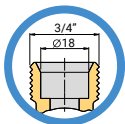

Cod	Dimensiune	Cai	Pret €	Ambalare
392 0059	1"G	2		1/1
392 0060	1"G	3		1/1
392 0061	1"G	4		1/1
392 0062	1"G	5		1/1
392 0063	1"G	6		1/1
392 0064	1"G	7		1/1
392 0065	1"G	8		1/1
392 0066	1"G	9		1/1
392 0067	1"G	10		1/1
392 0068	1"G	11		1/1
392 0069	1"G	12		1/1
392 0215	1"G	13		1/1

Noutati

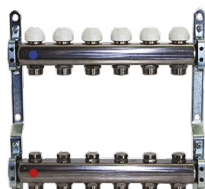

3866X

Colector de distributie de 1" din oțel inox AISI 304L cu iesiri 3/4"x18 (Eurocono) și vane cu memorie mecanică.

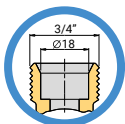

Cod	Dimensiune	Cai	Pret €	Ambalare
392 0070	1"G	2		1/1
392 0071	1"G	3		1/1
392 0072	1"G	4		1/1
392 0073	1"G	5		1/1
392 0074	1"G	6		1/1
392 0075	1"G	7		1/1
392 0076	1"G	8		1/1
392 0077	1"G	9		1/1
392 0078	1"G	10		1/1
392 0079	1"G	11		1/1
392 0080	1"G	12		1/1

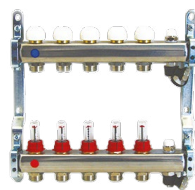

3855X

Colector de distributie de 1" din oțel inox AISI 304L, iesiri 3/4"x18 (Eurocono), indicatoare de debit, supape de aerisire și robineti de golire.

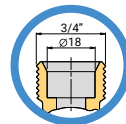

Cod	Dimensiune	Cai	Pret €	Ambalare
392 0081	1"G	2		1/1
392 0082	1"G	3		1/1
392 0083	1"G	4		1/1
392 0084	1"G	5		1/1
392 0085	1"G	6		1/1
392 0086	1"G	7		1/1
392 0087	1"G	8		1/1
392 0088	1"G	9		1/1
392 0089	1"G	10		1/1
392 0090	1"G	11		1/1
392 0091	1"G	12		1/1

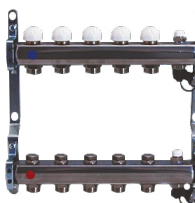

3865X

Colector de distributie de 1" din oțel inox AISI 304L, iesiri 3/4"x18 (Eurocono), vane cu memorie mecanică, supape de aerisire și robineti de golire.

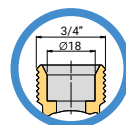

Cod	Dimensiune	Cai	Pret €	Ambalare
392 0092	1"G	2		1/1
392 0093	1"G	3		1/1
392 0094	1"G	4		1/1
392 0095	1"G	5		1/1
392 0096	1"G	6		1/1
392 0097	1"G	7		1/1
392 0098	1"G	8		1/1
392 0099	1"G	9		1/1
392 0100	1"G	10		1/1
392 0101	1"G	11		1/1
392 0102	1"G	12		1/1



13_B SET COLECTOARE DIN OTEL-INOX AISI 304L - 1"

Pentru utilizare cu caseta 1939 (pag. 294)



3891N

Kit terminal pentru colectoare
3856X - 3866X - 3856N - 3866N

Cod	Dimensiune	Pret €	Ambalare
450 0441	1"		1/10



3891NBY

Kit terminal cu by-pass pentru
colectoare 3856X - 3866X -
3856N - 3866N

Cod	Dimensiune	Pret €	Ambalare
450 0442	1"		1/10



3891NJ

Kit terminal pentru colectoare

Cod	Dimensiune	Pret €	Ambalare
450 0484	1"		1/5



3891NBYJ

Kit terminal cu by-pass pentru
colectoare

Cod	Dimensiune	Pret €	Ambalare
450 0485	1"		1/8

GHID DE ACCESORII

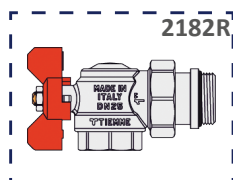

2182R



9567

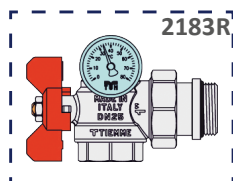

2183R

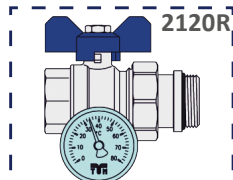

2120R

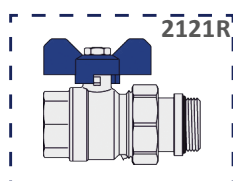

2121R

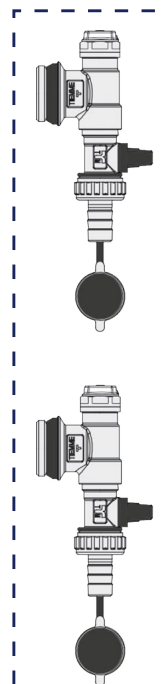
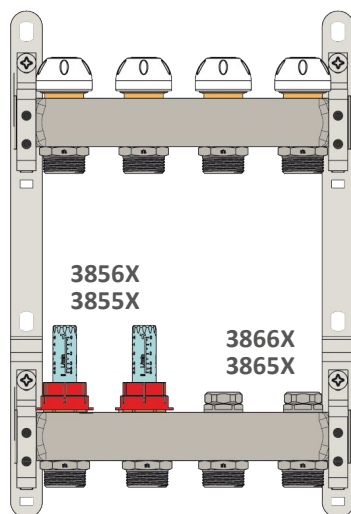

3891N
3891NJ

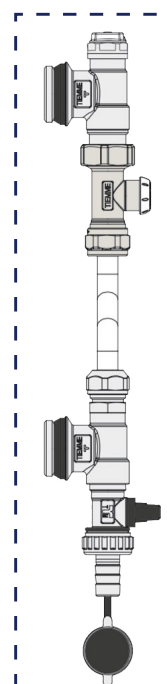



3891NBY
3891NBYJ

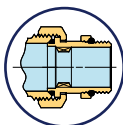

2121R

Set robineti drepti drept cu olandez si O-RING, cu pre-etansare



Cod	Dimensiune	Pret €	Ambalare
 maneta tip fluture rosie			
212 0013	1"		9/36
 maneta tip fluture albastra			
212 0014	1"		9/36



2121RSAC

Set robinet drept cu maneta tip fluture de culoare rosie si albastra cu olandez si garnitura O-RING, cu pre-etansare

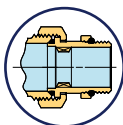

Cod	Dimensiune	Pret €	Ambalare
386 0035	1"		1/10



Nr 1 cu maneta tip fluture de culoare albastra + Nr 1 cu maneta tip fluture de culoare rosie

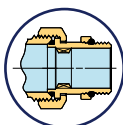

2182R

Robinet de colt cu olandez si garnitura O-RING, cu pre-etansare



Cod	Dimensiune	Pret €	Ambalare
 maneta tip fluture rosie			
212 0048	1"		5/20
 maneta tip fluture albastra			
212 0044	1"		5/20



2182RSAC

Set robineti M/F de colt ISO 228 cu maneta tip fluture de culoare rosie si albastra pentru colectoare, cu etansare si prindere pe O-RING, cu pre-etansare

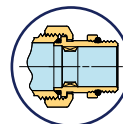

Cod	Dimensiune	Pret €	Ambalare
386 0032	1"		1/10

Nr 1 cu maneta tip fluture de culoare albastra + Nr 1 cu maneta tip fluture de culoare rosie



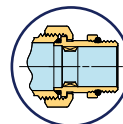

2120R

Robinet drept cu olandez, garnitura O-RING si termometru cu prindere reversibila, cu pre-etansare



BREVETAT

Cod	Dimensiune	Pret €	Ambalare
 maneta tip fluture rosie			
212 0043	1"		5/20
 maneta tip fluture albastra			
212 0042	1"		5/20



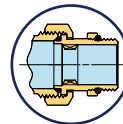

2183R

Robinet M/F de colt ISO 228 cu maneta tip fluture de culoare rosie sau albastra, cu pre-etansare, garnitura O-RING si termometru cu prindere reversibila, cu pre-etansare



BREVETAT

Cod	Dimensiune	Pret €	Ambalare
 maneta tip fluture rosie			
212 0031	1"		5/20
 maneta tip fluture albastra			
212 0032	1"		5/20

 Pentru gama completă de supape cu bilă, vezi capitolul 1 A



2114CPRKIT

Set robineti sfera cu olandez garnitura plata model drept compact, cu maneta tip fluture culoare rosie si albastra si termometre ce au conexiune reversibila

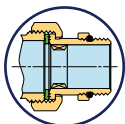

 BREVETAT

Cod	Dimensiune	Pret €	Ambalare
212 0195	1"		1/10



2184CPRKIT

Set robineti sfera cu olandez garnitura plata model coltar compact, cu maneta tip fluture culoare rosie si albastra si termometre ce au conexiune reversibila

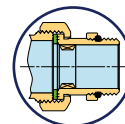

 BREVETAT

Cod	Dimensiune	Pret €	Ambalare
212 0197	1"		1/10



2116CPRKIT

Set robineti sfera cu olandez garnitura plata model drept compact, cu maneta tip fluture culoare rosie si albastra fara termometre

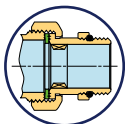

 BREVETAT

Cod	Dimensiune	Pret €	Ambalare
212 0196	1"		1/10



2186CPRKIT

Set robineti sfera cu olandez garnitura plata model coltar compact, cu maneta tip fluture culoare rosie si albastra fara termometre

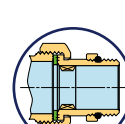

 BREVETAT

Cod	Dimensiune	Pret €	Ambalare
212 0198	1"		1/10



9567

Servocomanda electrotermica pentru robinet termostaticabil de inchidere cu indicator de cursa.

NORMAL INCHIS

Cod	Dimensiune	Pret €	Ambalare
450 0026	24V		1/20
450 0012	230V		1/20
450 0045	24V		1/20
450 0006	230V		1/20

Versiuni cu microinterruptor auxiliar



H9709

Indicatoare de debit pentru Colector de distributie FLOOR

Cod	Dimensiune	Pret €	Ambalare
040 0196	-		5/100



H9708

Ventil termostaticabil pentru colector de distributie FLOOR

Cod	Dimensiune	Pret €	Ambalare
040 0241	1"		10/50
040 0287	1"1/4		10/50

Noutati



2070

Termometru Ø 40 L=30 mm scara 0 ÷ 80°C

Cod	Dimensiune	Pret €	Ambalare
179 0006	-		10/50



3352

Supapa de aerisire pentru radiatoare

Cod	Dimensiune	Pret €	Ambalare
198 0047	3/8"		10/500
198 0018	1/2"		10/500



2990G

Robinet cu sfera pentru golire



Cod	Dimensiune	Pret €	Ambalare
295 0001	1/2"		25/100
295 0040	1/2"		10/50

Varianta cu lant metalic

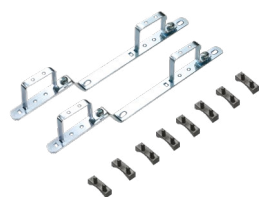

1863

Set de prindere pentru colectoare "FLOOR" pentru caseta Art. 1931-1939-1940

Cod	Dimensiune	Pret €	Ambalare
181 0032	1"		1/25
181 0203	1"1/4		1/25



5533
Set deviator pentru distribuitor

Cod	Dimensiune	Pret €	Ambalare
556 0456	1"		1/1

5533 EXEMPLU DE UTILIZARE

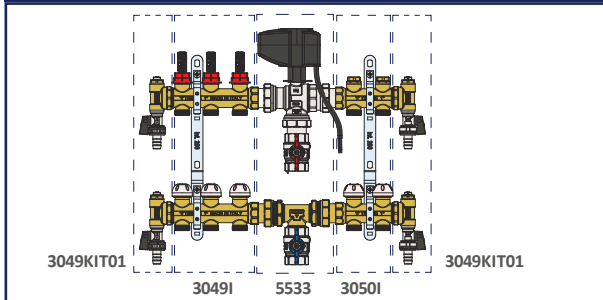

5533ISOL
Izolatie pentru set deviator

Cod	Dimensiune	Pret €	Ambalare
556 0459	1"		1/5

NOUȚĂȚI



4729
Supapa de sens termostatica

Cod	Dimensiune	Pret €	Ambalare
324 0025	3/4"(18) Eurocono		20/80

4729 EXEMPLU DE UTILIZARE

FUNCȚIE ÎNCĂLZIRE:
T tur > 19°C

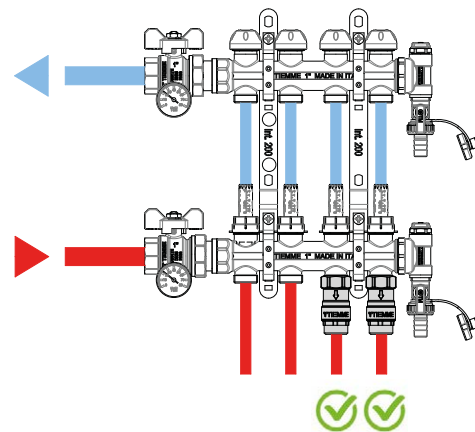

FUNCȚIE RĂCIRE:
T tur < 19°C

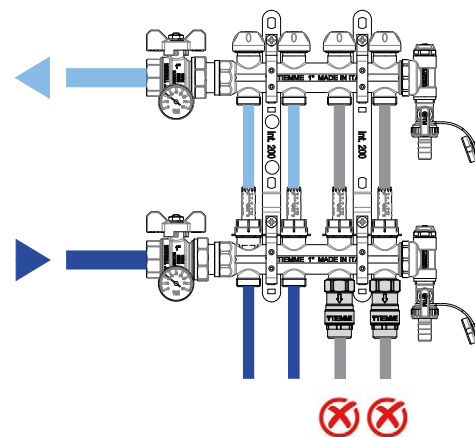



1939

Caseta reglabila pe inaltime si in adancime pentru colectoare tip bara si "FLOOR". Necesita seturi de prindere art. 1865-1864 in functie de diametrul colectorului

i Adancime reglabila de la 90 mm la 140 mm

Cod	Dimensiune	Pret €	Ambalare
181 0192	400 x 660 x 90 ÷ 140		1/1
181 0193	500 x 660 x 90 ÷ 140		1/1
181 0206	600 x 660 x 90 ÷ 140		1/1
181 0194	700 x 660 x 90 ÷ 140		1/1
181 0195	1000 x 660 x 90 ÷ 140		1/1

1939

DIMENSIUNE

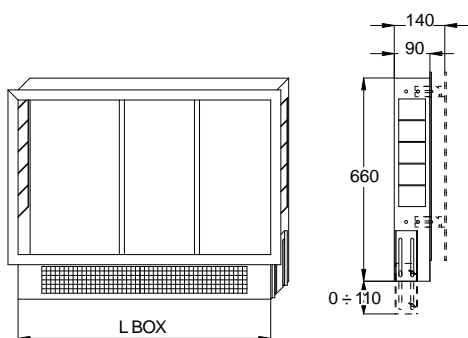

GHID DE ALEGERE A CASETELOR

COMPATIBILITATEA COLECTORULUI

3873J - 3873BYD - 3878 - 3878BYD - 3049 - 3049I - 3050 3050I - 3856N - 3866N - 3856X - 3866X - 3855X - 3865X

Nr. circuite	L* (mm)	L BOX (mm)	Cod
2	232	400	181 0192
3	282		
4	332		
5	382	500	181 0193
6	432		
7	482	600	181 0206
8	532		
9	582	700	181 0194
10	632		
11	682	1000	181 0195
12	732		
13	782		
14	832		

* Latimea colectorului



1940

Caseta reglabila pe inaltime si in adancime pentru grupuri de amestec si distributie si colectoare.

Necesita seturi de prindere

i Adancime reglabila de la 120 mm la 170 mm

Cod	Dimensiune	Pret €	Ambalare
181 0020	600 x 670 x 120 ÷ 170		1/1
181 0016	700 x 670 x 120 ÷ 170		1/1
181 0015	850 x 670 x 120 ÷ 170		1/1
181 0019	1000 x 670 x 120 ÷ 170		1/1
181 0025	1200 x 670 x 120 ÷ 170		1/1

1940

DIMENSIUNE

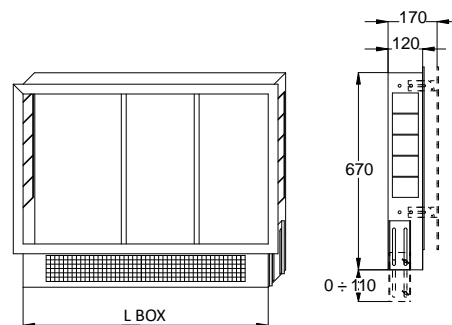

GHID DE ALEGERE A CASETELOR

COMPATIBILITATEA COLECTORULUI

3873RJ - 3873RBYDJ - 3878R - 3878RBYD - 3877 - 3877BYD - 3879 - 3879BYD - 3877R - 3877RBYD - 3879R - 3879RBYD

Nr. circuite	L* (mm)	L BOX (mm)	Cod
2	262	600	181 0020
3	312		
4	362		
5	412		
6	462	700	181 0016
7	512		
8	562		
9	612	850	181 0015
10	662		
11	712		
12	762		

* Latimea colectorului

i - Pentru produsele art. 3049 - 3049I - 3050 - 3050I - 3856N - 3866N - 3856X - 3866X - 3855X - 3865X dimensiunea L include robinetii cu sfera și seturi de terminale ca accesorii





1436

Pentru tub PEX

Adaptor pentru conexiuni
3/4"x18 (EUROCONO)

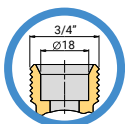

Cod	Dimensiune	Pret €	Ambalare
144 0099	16 x 2,0 - 3/4"(ϕ 18)		10/250
144 0085	17 x 2,0 - 3/4"(ϕ 18)		10/200
144 0089	20 x 2,0 - 3/4"(ϕ 18)		10/200



1436N

Pentru tub PEX

Adaptor pentru conexiuni
3/4"x18 (EUROCONO)
Versiunea nichelata

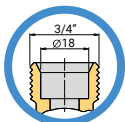

Cod	Dimensiune	Pret €	Ambalare
144 0011	16 x 2,0 - 3/4"(ϕ 18)		10/250
144 0012	17 x 2,0 - 3/4"(ϕ 18)		10/200
144 0019	20 x 2,0 - 3/4"(ϕ 18)		10/200



1636

Pentru tub MULTISTRAT

Adaptor pentru conexiuni
3/4"x18 (EUROCONO)

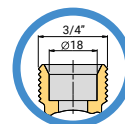

Cod	Dimensiune	Pret €	Ambalare
144 0080	16 x 2,0 - 3/4"(ϕ 18)		10/250
144 0172	17 x 2,0 - 3/4"(ϕ 18)		10/200
144 0100	20 x 2,0 - 3/4"(ϕ 18)		10/200



1636N

Pentru tub MULTISTRAT

Adaptor pentru conexiuni
3/4"x18 (EUROCONO)
Versiunea nichelata

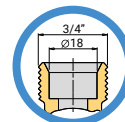

Cod	Dimensiune	Pret €	Ambalare
144 0002	16 x 2,0 - 3/4"(ϕ 18)		10/250
144 0033	17 x 2,0 - 3/4"(ϕ 18)		10/200
144 0003	20 x 2,0 - 3/4"(ϕ 18)		10/200

13_B SET COLECTOARE "INDUSTRIAL FLOOR" DIN ALAMA STANTATA – 1" 1/2

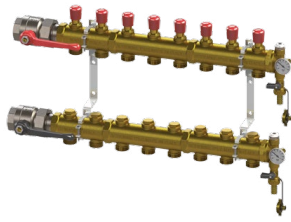

3874

Colector de distributie INDUSTRIAL FLOOR de 1"1/2 stantat din alama cu iesiri 1" M si robineti manuali

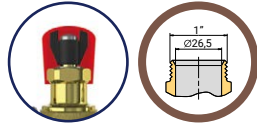

DESCRIERE:

Colector de distributie pentru incalzire in pardoseala din alama de 1"1/2 alcătuit din:

- Colector de tur si retur din alama CW617N conform normei EN12165
- Iesiri 1" cu robinet de reglare pe tur
- Robineti cu sfera 1"1/2 pe alimentare
- Termometre
- Robineti de incarcare/descarcare
- Supapa manuala de aerisire
- Set de prindere

Cod	Dim.	Cai	Iesiri	Pret €	Ambalare
385 0074	1"1/2G	5	1"G (Ø26,5)		1/1
385 0075	1"1/2G	6	1"G (Ø26,5)		1/1
385 0076	1"1/2G	7	1"G (Ø26,5)		1/1
385 0077	1"1/2G	8	1"G (Ø26,5)		1/1
385 0078	1"1/2G	9	1"G (Ø26,5)		1/1
385 0079	1"1/2G	10	1"G (Ø26,5)		1/1
385 0080	1"1/2G	11	1"G (Ø26,5)		1/1
385 0081	1"1/2G	12	1"G (Ø26,5)		1/1
385 0082	1"1/2G	13	1"G (Ø26,5)		1/1
385 0083	1"1/2G	14	1"G (Ø26,5)		1/1

3874

GHID DE CONEXIUNI

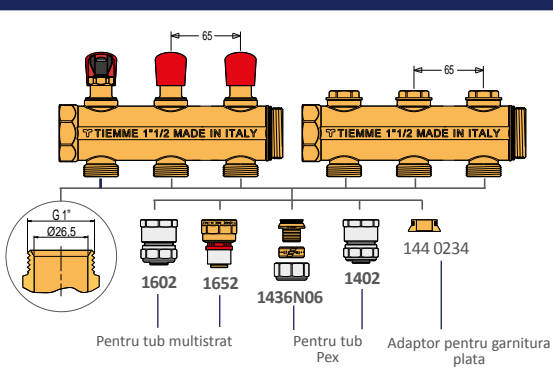

1436N06

Adaptor pentru conexiuni 1" pentru tub PEX



Cod	Dimensiune	Pret €	Ambalare
144 0232	20 x 2,0 - 1" G (Ø26,5)		10/200
144 0075	25 x 2,3 - 1" G (Ø26,5)		10/200



1859

Adaptor pentru conexiuni 1" G

Cod	Dimensiune	Pret €	Ambalare
144 0234	1"G		10/300



3874P

Capac de protectie

Cod	Dimensiune	Pret €	Ambalare
179 0037	-		5/50



1889TERMO

Teu feminin cu filet fazat si suport termometru

Cod	Dimensiune	Pret €	Ambalare
195 0076	1"1/4 x 1/2" x 1/2"		5/50
195 0064	1"1/2 x 1/2" x 1/2"		5/50



3874ISOL

Carcasa de izolare pentru colector de distributie 1"1/2

Cod	Dimensiune	Pret €	Ambalare
557 0520	2 vias		1/5
557 0522	3 vias		1/5



1890ISOL

Izolatie grup terminal cu supapa de aerisire

Cod	Dimensiune	Pret €	Ambalare
557 0516	1"1/4 - 1"1/2		1/10



13_B SET COLECTOARE "INDUSTRIAL FLOOR" DIN ALAMA STANTATA - 1" 1/2



9567KIT
Adaptor INDUSTRIAL FLOOR
pentru servocomanda
electrotermica 9567

Cod	Dimensiune	Pret €	Ambalare
179 0328	-		1/100

9567-9567KIT INSTRUȚIUNI DE MONTAJ

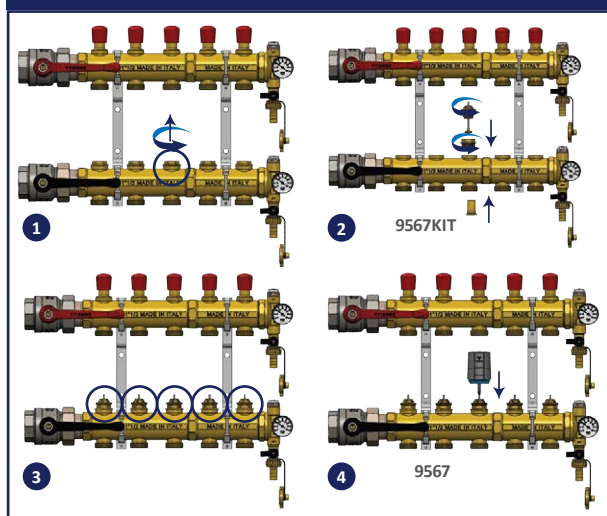

1

2

9567KIT

3

4

9567

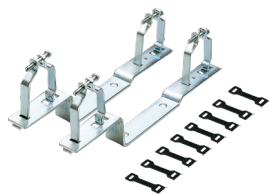

1865
Set de prindere universal pentru
colectoare stantate "INDUSTRIAL
FLOOR"

Cod	Dimensiune	Pret €	Ambalare
181 0007	1"1/2		1/25



1941
Casetă externă pentru
colectoare "INDUSTRIAL FLOOR"

Cod	Dimensiune	Pret €	Ambalare
181 0110	900 x 650 x 170		1/1
181 0111	1200 x 650 x 170		1/1

1941 DIMENSIUNE

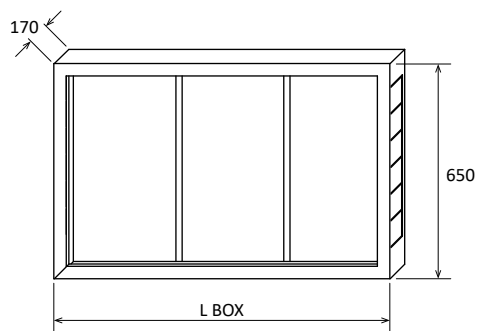

GHID DE ALEGEREA CASETELOR

COMPATIBILITATEA COLECTORULUI

Nr. circuite	L* (mm)	L BOX (mm)	Cod
5	495	900	181 0110
6	560		
7	625		
8	690		
9	755		
10	820	1200	181 0111
11	885		
12	950		
13	1015		
14	1080		

* Latimea colectorului



3898N

Grup de amestec pentru instalatii radiante. Versiunea nichelata

DESCRIERE

- Termostat de siguranță temperatură fixă (55°C)
- 1 Termometru (temperatură tur)
- By-pass
- Supapă de sens

Cod	Dimensiune	Pret €	Ambalare
389 0049	Fără pompă		1/5
389 0050	Wilo PARA 25/7		1/1

ErP READY

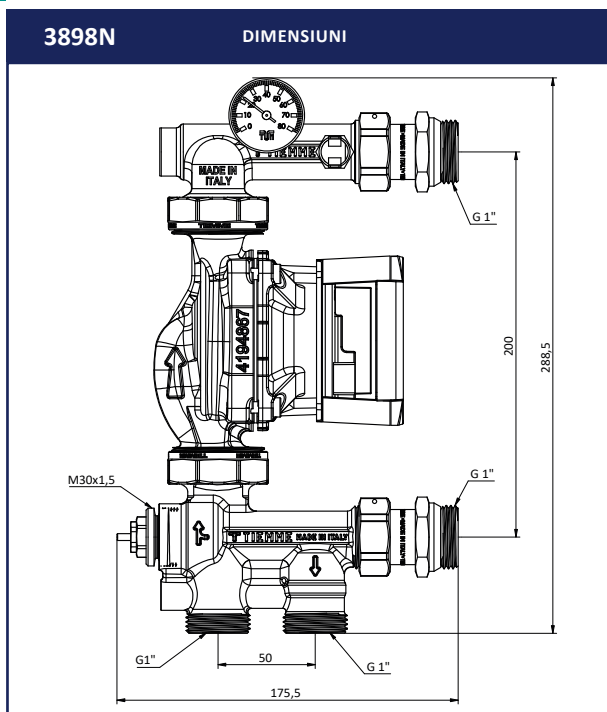

3898N

DIMENSIUNI



3898KHT

Kit de distribuție de înaltă temperatură

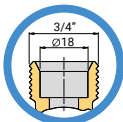

DESCRIERE:

Kit compus din:

- Colectoare de distribuție din alama 1" 3 căi cu racorduri 3/4"x18 Eurocono și robineti termostaticabili
- Colectoare de distribuție din alama 1" 3 căi cu racorduri 3/4"x18 Eurocono și vane cu memorie mecanică
- Accesorii de conectare

Cod	Dimensiune	Pret €	Ambalare
450 0715	1" 3 căi		1/2



2286KIT

Set robineti drept M ISO 228 cu piulita și maneta tip fluture culoare roșie și albastră

Cod	Dimensiune	Pret €	Ambalare
226 0200	1"		1/25



3898I

Izolație termică termoformată pentru grup de amestec

Cod	Dimensiune	Pret €	Ambalare
557 0698	3898N		1/1

La cerere



3898IHT

Izolație termică termoformată pentru kit de distribuție de înaltă temperatură

Cod	Dimensiune	Pret €	Ambalare
557 0695	3898KHT		1/1

La cerere

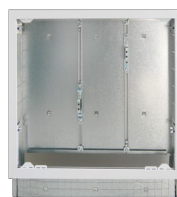

1931

Caseta din metal prevăzută cu seturi pentru kit de amestec

Adâncime reglabilă de la 120 mm la 170 mm

Cod	Dimensiune	Pret €	Ambalare
181 0255	600 x 670 x 120 ÷ 170		1/1





3895KPF

Kit de reglare cu punct fix setabil (20÷50°C)



DESCRIERE:

Kit compus din:

- Cap termostatic cu sondă la distanță și câmp de reglare 20÷50°C
- Teacă port sondă (cod.040 0180)
- Casetă legături electrice (pompa și termostat de siguranță)

Cod	Dimensiune	Pret €	Ambalare
450 0376	-		1/1



3895KCL

Kit de reglare a temperaturii pentru încălzire/racire



DESCRIERE:

Kit compus din:

- Servocomanda 0÷10V NC cu alimentare 24V
- Teacă port sondă Ø6 montaj uscat
- Cablu de legatură pentru termostatul de siguranță
- Sonda de temperatură NTC 10K@25°C, diametru 6 mm

Cod	Dimensiune	Pret €	Ambalare
450 0377	-		1/1

3898N

EXEMPLU DE UTILIZARE

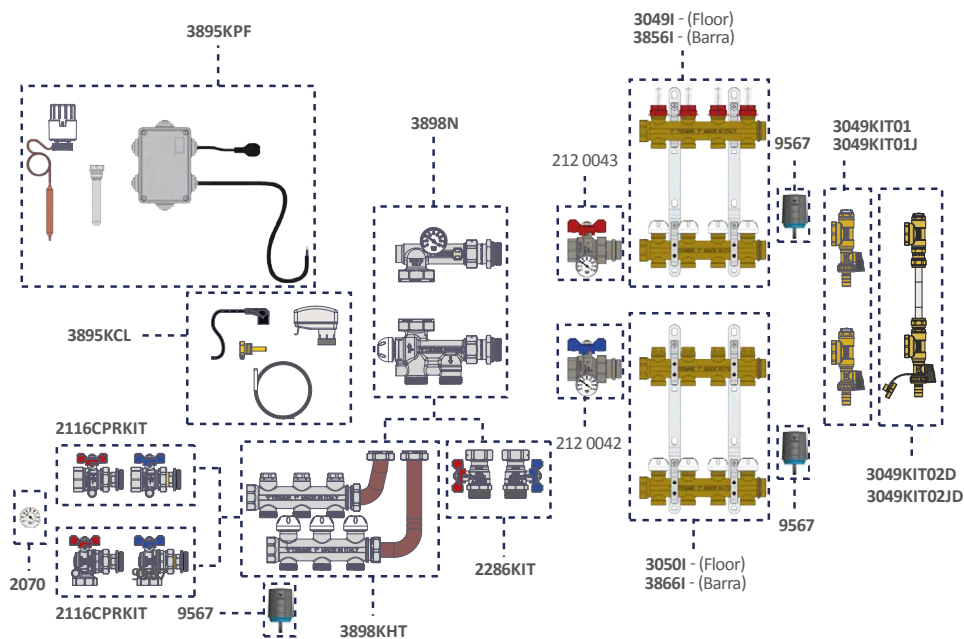

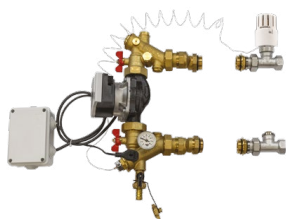

3899G3

Grup de amestec si distributie premontat cu robinet drept termostatic

DESCRIERE:

- Racorduri pentru alimentare pe 3/4" F
- Robinet termostatic drept cu comanda 20-50°C
- Pompa de circulatie
- Kit de conexiuni electrice
- Termostate de siguranta cu punct fix 55°C (EN1264)
- Termometru (inclus)
- Supapa de aerisire si robineti de incarcare/descarcare
- Racorduri cu preetansare nealiniata (30 mm) pentru colectoare de distributie premontate (art. 3856 sau 3866)

Cod	Dim.	Model pompa	Pret €	Ambalare
389 0023	1"	Fără pompă		1/1
389 0008	1"	Wilo PARA 25/7		1/1

ErP READY

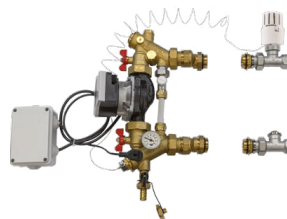

3899G3BY

Grup de amestec si distributie premontat cu robinet drept termostatic

DESCRIERE:

- Racorduri pentru alimentare pe 3/4" F
- Robinet termostatic drept cu comanda 20-50°C
- Detentor de echilibrare
- Pompa de circulatie
- Kit de conexiuni electrice
- Termostate de siguranta cu punct fix 55°C (EN1264)
- Termometru (inclus)
- Supapa de aerisire si robineti de incarcare/descarcare
- Racorduri cu preetansare nealiniata (30 mm) pentru colector de distributie premontate (art. 3049, 3050, 3856 e 3866)
- By-pass cu detentor de echilibrare

CU BY-PASS

Cod	Dim.	Model pompa	Pret €	Ambalare
389 0024	1"	Fără pompă		1/1
389 0009	1"	Wilo PARA 25/7		1/1

ErP READY





1940

Caseta reglabila în înaltime si adancime pentru grupuri de amestec si distributie

i Adancime reglabila de la 120 mm la 170 mm

Cod	Dimensiune	Pret €	Ambalare
181 0020	600 x 670 x 120 ÷ 170		1/1
181 0016	700 x 670 x 120 ÷ 170		1/1
181 0015	850 x 670 x 120 ÷ 170		1/1
181 0019	1000 x 670 x 120 ÷ 170		1/1
181 0025	1200 x 670 x 120 ÷ 170		1/1

EXEMPLU DE UTILIZARE

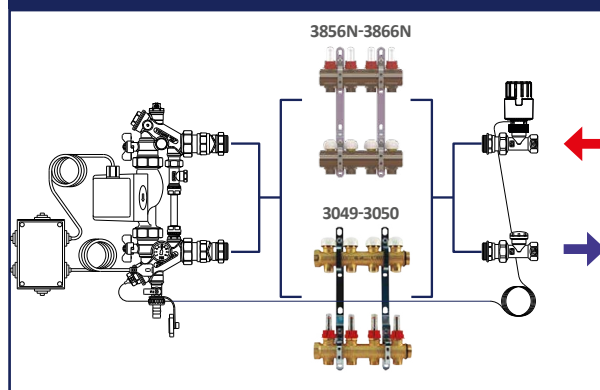

GHID DE ALEGEREA CASETELOR

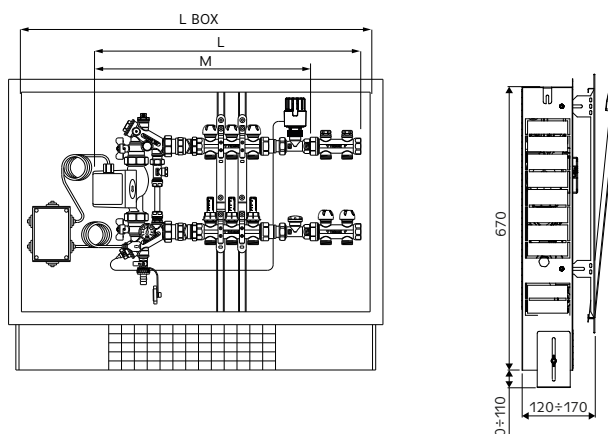

ALEGEREA CUTIEI

N. circuite	2	3	4	5	6	7	8	9	10	11	12
M (mm)	460	510	560	610	660	710	760	810	860	910	960
L BOX (mm)	600		700			850			1000		1200
Cod	181 0020		181 0016			181 0015			181 0019		181 0025

ALEGEREA CUTIEI PENTRU COLECTOARE CU 2 CIRCUITE SUPLIMENTARE DE INALTA TEMPERATURA

N. circuite	2	3	4	5	6	7	8	9	10	11	12
L (mm)	580	630	680	730	780	830	880	930	980	1030	1080
L BOX (mm)	700		850			1000			1200		
Cod	181 0016		181 0015			181 0019			181 0025		

ALEGEREA CUTIEI PENTRU COLECTOARE CU 3 CIRCUITE SUPLIMENTARE DE INALTA TEMPERATURA

N. circuite	2	3	4	5	6	7	8	9	10	11	12
L (mm)	630	680	730	780	830	880	930	980	1030	1080	1130
L BOX (mm)	700		850			1000			1200		
Cod	181 0016		181 0015			181 0019			181 0025		



3890VD

Vana termostatica cu 3 cai deviatie/amestec pentru gestiunea instalatiilor de incalzire si racire.

In functie de pozitia de montaj functioneaza ca vana deviatoare sau ca vana de amestec.

Cod	Dimensiune	Pret €	Ambalare
450 0047	1"		2/20
450 0515	1"1/4		1/10
450 0516	1"1/2		1/10

3890VD

GHID DE INSTALARE

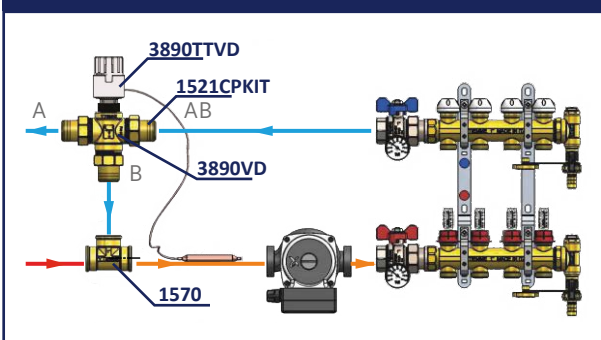

3890VDKIT

Kit olandez pentru Vana termostatica cu 3 cai deviatie/ amestec

i Kit-ul cuprinde: 3 stuturi filetate, 3 piulite, 3 garnituri

Cod	Dimensiune	Pret €	Ambalare
150 1017	1" F x 3/4" M		1/20
150 1013	1"1/4 F x 1" M		1/15
150 1014	1"1/2 F x 1"1/4 M		1/10



1570

Teu F

Cod	Dimensiune	Pret €	Ambalare
150 0009	3/4" x 3/4" x 3/4"		5/50
150 0005	1" x 1" x 1"		5/25
150 0029	1"1/4 x 1"1/4 x 1"1/4		5/20



3890TTVD

Cap termostatic cu sonda la distanta pentru supapa de deviere

Cod	Dimensiune	Pret €	Ambalare
450 0527	20 - 50°C		1/10
450 0556	40 - 70°C		1/10



13_B GRUP DE AMESTEC SI DISTRIBUTIE CU PUNCT FIX - 1"

3868G - 3868GHPPP2 - 3868GHPPP3

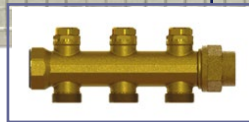
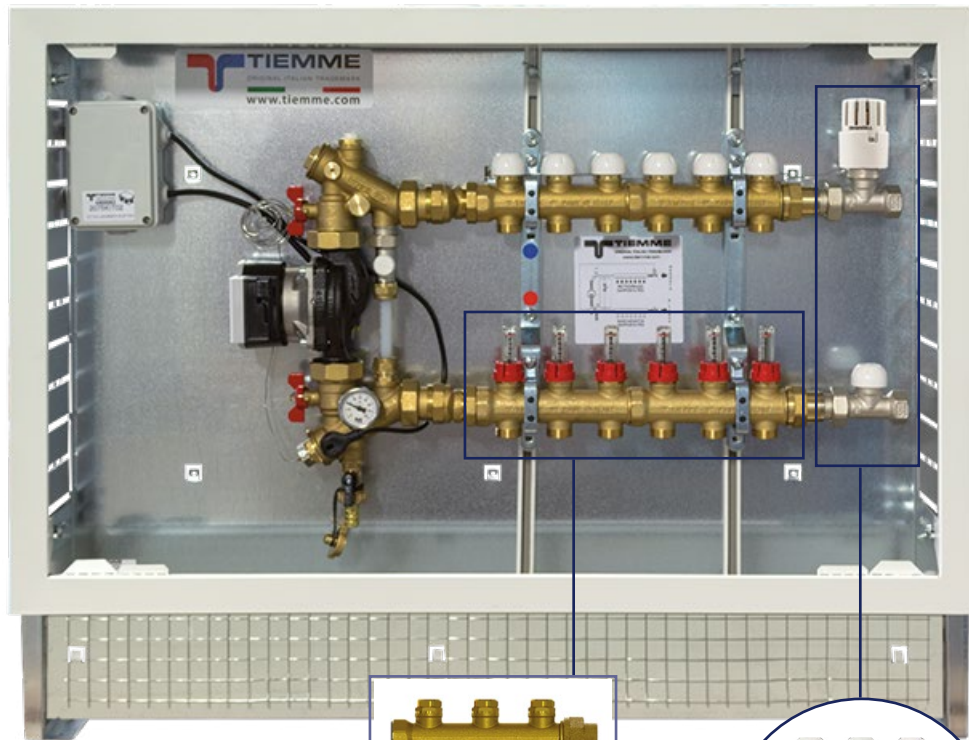

VERSIUNEA CU COLECTOR
SUPLIMENTAR DE
TEMPERATURA INALTA

DESCRIERE

Grup de amestec și distribuție pentru sisteme radiante pre-asamblat într-o cutie metalică format din:

- Kit de amestec cu reglare punct fix
- Pompă de circulație de înaltă eficiență (EEI 0.23) cu viteză variabilă și magneți permanenți.
- Distribuitor modular de tur complet cu reglare a debitului prin intermediul debitmetrelor cu ieșiri de 3/4 "x18 (Eurocon)
- Distribuitor modular de retur cu supape de închidere termostatică cu ieșiri de 3/4 "x18 (Eurocon)
- Ventil de aerisire și robinet de încărcare/descărcare
- Modele disponibile cu kit de temperatură înaltă cu 2 - 3 căi pentru calorifere
- Înveliș izolator din spumă de polietilenă termoformată

DIMENSIUNE

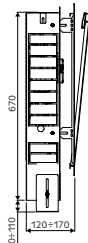
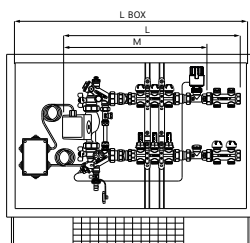

Pentru tabelul de dimensiuni vezi pagina anterioară

13_B GRUP DE AMESTEC SI DISTRIBUTIE CU PUNCT FIX - 1"

3868G - 3868GHTPP2 - 3868GHTPP3



3868G

Grup de amestec și distribuție cu punct fix și by-pass.



Cod	Dimensiune	Cai	Pret €	Ambalare
391 0103	1"G	2		1/1
391 0110	1"G	3		1/1
391 0101	1"G	4		1/1
391 0098	1"G	5		1/1
391 0028	1"G	6		1/1
391 0077	1"G	7		1/1
391 0064	1"G	8		1/1
391 0111	1"G	9		1/1
391 0071	1"G	10		1/1
391 0059	1"G	11		1/1
391 0062	1"G	12		1/1
Versiunea cu vane cu memorie mecanica				
391 0112	1"G	2		1/1
391 0113	1"G	3		1/1
391 0102	1"G	4		1/1
391 0114	1"G	5		1/1
391 0079	1"G	6		1/1
391 0099	1"G	7		1/1
391 0115	1"G	8		1/1
391 0093	1"G	9		1/1
391 0116	1"G	10		1/1
391 0092	1"G	11		1/1
391 0117	1"G	12		1/1

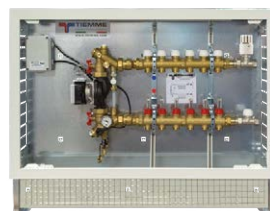

3868GHTPP2

Grup de amestec și distribuție cu reglare punct fix, by-pass și kit de temperatură înaltă în 2 cai

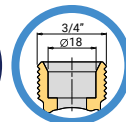

Cod	Dimensiune	Cai	Pret €	Ambalare
391 0118	1"G	2		1/1
391 0097	1"G	3		1/1
391 0074	1"G	4		1/1
391 0036	1"G	5		1/1
391 0047	1"G	6		1/1
391 0029	1"G	7		1/1
391 0058	1"G	8		1/1
391 0052	1"G	9		1/1
391 0051	1"G	10		1/1
391 0061	1"G	11		1/1
391 0128	1"G	12		1/1
Versiunea cu vane cu memorie mecanica				
391 0130	1"G	2		1/1
391 0132	1"G	3		1/1
391 0053	1"G	4		1/1
391 0010	1"G	5		1/1
391 0024	1"G	6		1/1
391 0067	1"G	7		1/1
391 0044	1"G	8		1/1
391 0022	1"G	9		1/1
391 0040	1"G	10		1/1
391 0089	1"G	11		1/1
391 0054	1"G	12		1/1



13_B GRUP DE AMESTEC SI DISTRIBUTIE CU PUNCT FIX - 1"

3868G - 3868GHTPP2 - 3868GHTPP3

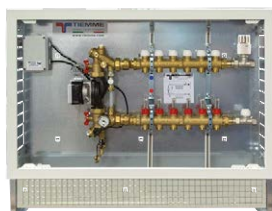

3868GHTPP3

Grup de amestec si distributie cu punct fix cu iesiri 3/4"x18 (Euro-con), by-pass si colector de temperatura inalta 3 cai

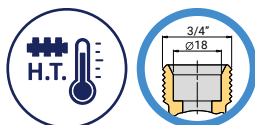

Cod	Dimensiune	Cai	Pret €	Ambalare
391 0119	1"G	2		1/1
391 0120	1"G	3		1/1
391 0121	1"G	4		1/1
391 0122	1"G	5		1/1
391 0123	1"G	6		1/1
391 0124	1"G	7		1/1
391 0125	1"G	8		1/1
391 0126	1"G	9		1/1
391 0085	1"G	10		1/1
391 0127	1"G	11		1/1
391 0129	1"G	12		1/1
Versiunea cu vane cu memorie mecanica				
391 0131	1"G	2		1/1
391 0133	1"G	3		1/1
391 0134	1"G	4		1/1
391 0135	1"G	5		1/1
391 0136	1"G	6		1/1
391 0088	1"G	7		1/1
391 0137	1"G	8		1/1
391 0084	1"G	9		1/1
391 0087	1"G	10		1/1
391 0073	1"G	11		1/1
391 0138	1"G	12		1/1

13_B GRUP DE AMESTEC SI DISTRIBUTIE CU PUNCT FIX - 1"

3896PF - 3896PFBYD - 3896PFHT - 3896PFHTBYD



PÂNĂ LA TERMINAREA STOCULUI

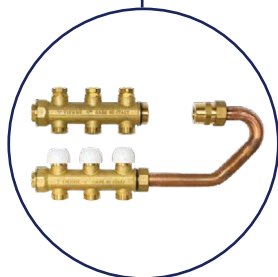
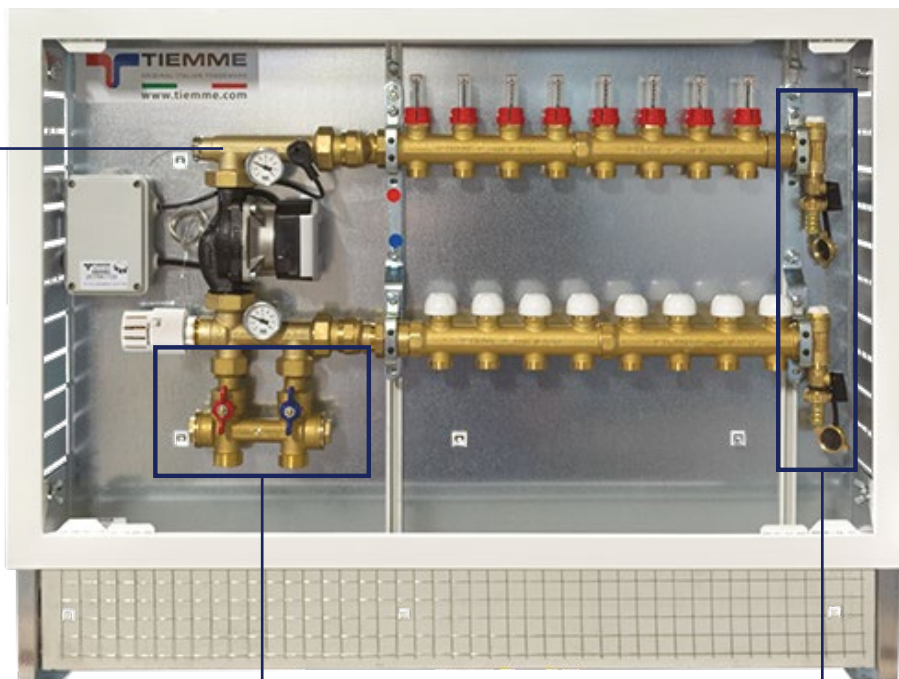

VERSIUNEA CU COLECTOR SUPPLEMENTAR DE TEMPERATURA INALTA

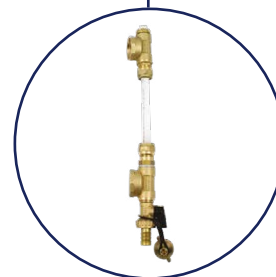

VERSIUNE CU BY-PASS DIFERENTIAL

DESCRIERE

Grup de amestec și distribuție pentru sisteme radiante pre-asamblat într-o cutie metalica format din:

- Kit de amestec cu reglare punct fix
- Pompă de circulație de înaltă eficiență (EEI 0.23) cu viteză variabilă și magneți permanenți.
- Distribuitor modular de tur complet cu reglare a debitului prin intermediul debitmetrelor cu iesiri de 3/4 "x18 (Eurocon)
- Distribuitor modular de retur cu supape de închidere termostatică cu ieșiri de 3/4 "x18 (Eurocon)
- Ventil de aerisire și robinet de încărcare/descărcare
- Sunt disponibile modelele cu by-pass și kit cu 3 căi de înaltă temperatură pentru radiatoare

DIMENSIUNE

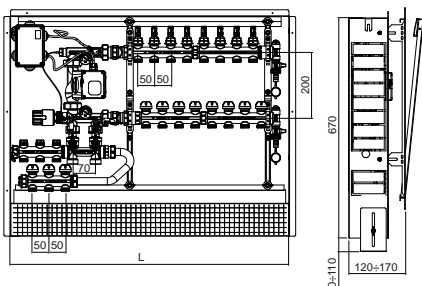

N. circuite	2	3	4	5	6	7	8	9	10	11	12
L (mm)	600	700	850	1000	1200						



LISTA DE PREȚURI

13_B GRUP DE AMESTEC SI DISTRIBUTIE CU PUNCT FIX - 1"

3896PF - 3896PFBYD - 3896PFHT - 3896PFHTBYD



3896PF

Grup de amestec și distribuție cu reglare cu punct fix

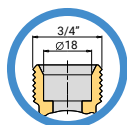

Cod	Dimensiune	Cai	Pret €	Ambalare
390 0444	1"G	2		1/1
390 0445	1"G	3		1/1
390 0446	1"G	4		1/1
390 0447	1"G	5		1/1
390 0448	1"G	6		1/1
390 0449	1"G	7		1/1
390 0450	1"G	8		1/1
390 0451	1"G	9		1/1
390 0452	1"G	10		1/1
390 0453	1"G	11		1/1
390 0454	1"G	12		1/1



3896PFHT

Grup de amestec și distribuție cu reglare punct fix și kit de temperatură înaltă

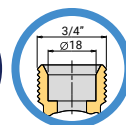

Cod	Dimensiune	Cai	Pret €	Ambalare
390 0488	1"G	2		1/1
390 0489	1"G	3		1/1
390 0490	1"G	4		1/1
390 0491	1"G	5		1/1
390 0492	1"G	6		1/1
390 0493	1"G	7		1/1
390 0494	1"G	8		1/1
390 0495	1"G	9		1/1
390 0496	1"G	10		1/1
390 0497	1"G	11		1/1
390 0498	1"G	12		1/1



3896PFBYD

Grup de amestec și distribuție cu punct fix și by-pass diferential

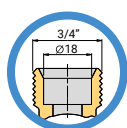

Cu by-pass diferential

Cod	Dimensiune	Cai	Pret €	Ambalare
390 0466	1"G	2		1/1
390 0467	1"G	3		1/1
390 0468	1"G	4		1/1
390 0469	1"G	5		1/1
390 0470	1"G	6		1/1
390 0471	1"G	7		1/1
390 0472	1"G	8		1/1
390 0473	1"G	9		1/1
390 0474	1"G	10		1/1
390 0475	1"G	11		1/1
390 0476	1"G	12		1/1



3896PFHTBYD

Grup de amestec și distribuție cu reglare punct fix, by-pass diferential și kit de temperatură înaltă

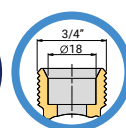

Cu by-pass diferential

Cod	Dimensiune	Cai	Pret €	Ambalare
390 0510	1"G	2		1/1
390 0511	1"G	3		1/1
390 0512	1"G	4		1/1
390 0513	1"G	5		1/1
390 0514	1"G	6		1/1
390 0515	1"G	7		1/1
390 0516	1"G	8		1/1
390 0517	1"G	9		1/1
390 0518	1"G	10		1/1
390 0519	1"G	11		1/1
390 0520	1"G	12		1/1



9567

Servocomanda electrotermica pentru robinet termostaticabil de inchidere cu indicator de cursa.

NORMAL INCHIS

Cod	Dimensiune	Pret €	Ambalare
450 0026	24V		1/20
450 0012	230V		1/20
450 0045	24V		1/20
450 0006	230V		1/20

Versiuni cu microintrerupator auxiliar



9561KIT01

Cap termostatic cu sonda la distanta si teaca cu racord 1/2". Domeniu de reglare 20-50°C

Cod	Dimensiune	Pret €	Ambalare
450 0032	20-50°C		1/10



2075KIT02

Set de conexiuni electrice pentru grupul de mixare, gestionarea pompei de circulatie, contact auxiliar pentru boilerul sau supapa de zona, intrare pentru termostat ambiental si termostat de siguranta, cutie de borne detașabilă pentru facilitarea activității instalatorului

i Regleta detașabila pentru a facilita munca instalatorului

i Se livreaza complet cu cabluri pentru conectarea pompei de circulatie si a termostatului de siguranta

Cod	Dimensiune	Pret €	Ambalare
450 0063	120 x 80 x H60 mm		1/10



2075KIT01

Termostat de siguranta bimetalic cu pastila si surub de fixare M4. Temperatura de interventie 55°C. Tip contact (normal inchis) 10 A 250 Vac. Furnizat impreuna cu cablul de conexiune

Cod	Dimensiune	Pret €	Ambalare
450 0051	55°C		1/50



3049SKIT

Kit de fixare a colectoarelor FLOOR

Cod	Dimensiune	Pret €	Ambalare
385 0063	1"		1/5



3890SKIT

Kit de fixare a colectoarelor bara

Cod	Dimensiune	Pret €	Ambalare
181 0043	1"		1/5

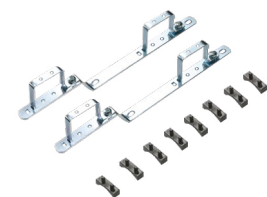

1863

Set de prindere pentru colectoare "FLOOR" pentru caseta Art. 1931-1939-1940

Cod	Dimensiune	Pret €	Ambalare
181 0032	1"		1/25
181 0203	1"1/4		1/25



1864P

Suport pentru fixarea direct pe perete a colectorelui bara de 1"-1"1/4

Cod	Dimensiune	Pret €	Ambalare
181 0041	1"		1/25
181 0042	1"1/4		1/25





3891G0001
Kit terminal cu by-pass pentru grupuri de amestec si distributie 3899

Cod	Dimensiune	Pret €	Ambalare
450 0065	unica		1/6



3887
Robinet cu sfera multifunctional pentru grupuri de amestec si distributie

Cod	Dimensiune	Pret €	Ambalare
450 0050	1"		2/6



3890PW2
Pompa de circulatie de inalta eficienta Wilo PARA 25/7 cu interaxă 130 mm. Iesire 1" 1/2 corp de fontă

+ POMPA DE MARE EFICIENTA

Cod	Dimensiune	Pret €	Ambalare
450 0358	Wilo PARA 25/7		1/1



3890P
Pompa de circulație cu trei viteze. Iesiri de 1"1/2 interaxă 130 mm

Cod	Dimensiune	Pret €	Ambalare
450 0033	Grundfos UPS 25-55		1/1

Disponibila pentru tari non UE



3889
Olandez pompa 1"1/2 cu robinet sfera inCorprat, actionabil cu cheie hexagonala cu filet 1" interior

Cod	Dim.	Atac pompa	Pret €	Ambalare
450 0031	1"	1"1/2		2/40



3888
Olandez pompa 1"1/2 cu robinet sfera inCorprat, actionabil cu cheie hexagonala si legatura pentru teava cupru

Cod	Dim.	Atac pompa	Pret €	Ambalare
450 0041	22	1"1/2		1/50
450 0044	28	1"1/2		1/50

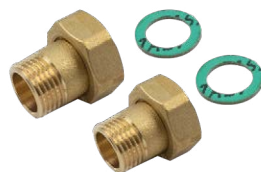

1555SET
Set olandez din alama pentru pompa cu racorduri M/F si garnitura plata.

i Setul include: 2 stuturi, 2 piulițe, 2 garnituri

Cod	Dim.	Atac pompa	Pret €	Ambalare
150 0825	1/2"	3/4"		1/50
150 0826	3/4"	1"		1/50
150 0827	1"	1"1/4		1/25
150 0578	1"1/4	1"1/2		1/20



1557SET
Set olandez din alama pentru pompa cu racorduri F/F si **GARNITURA PLATA**.
150 0355 pentru pompele: 35/130, 55/130, 65/130;
art.150 0440 pentru pompele: 50/180, 80/180, 110/180

i Setul include: 2 stuturi, 2 piulițe, 2 garnituri

Cod	Dim.	Atac pompa	Pret €	Ambalare
150 0906	1/2"	1"		1/50
150 0839	3/4"	1"1/4		1/25
150 0355	1"	1"1/2		1/20
150 0440	1"1/4	2"		1/10

14 TERMOREGLARE

Termostate si cronotermostate



312

Umidostate si cronoumidostate



314

Sisteme de termoreglare wireless



315

Sisteme de termoreglare Wi-Fi **TIEMME GATE >>**



317

Sisteme de termoreglare Wi-Fi **TIEMME NEXT >>**



318

Termostate de siguranta



319





9575
Termostat de ambient
electromecanic

CARACTERISTICI TEHNICE:

- Iesire: contact normal deschis 16 (2,5) A/250 Vac
- Domeniu de reglare: 5 – 30°C
- Grad de precizie: ± 0,5°C

Cod	Dimensiune	Pret €	Ambalare
957 0002	electromecanic		1/40



9587
Termostat electronic digital
montat pe perete pentru
controlul temperaturii camerei
atât la încălzire, cât și la racire.
Alimentare pe baterii.

CARACTERISTICI TEHNICE:

- Alimentare: 2 baterii AAA de 1,5 V
- Durata bateriei: 1 an
- Domeniu de reglare: 2 – 35°C
- Grad de precizie: ± 0,5°C

Cod	Dimensiune	Pret €	Ambalare
957 0178	electromecanic		1/60



9581
Termostat electronic cu
touchscreen

CARACTERISTICI TEHNICE:

- Display cu touchscreen
- Alimentare: 2 baterii AAA de 1,5 V
- Durata bateriei: 1 an
- 5 A (230 Vac)
- Functie VARA-IARNA-OFF
- Intrare digitala pentru modificarea setarii de referinta 3°C
- Domeniu de reglare: 2-50°C
- Grad de precizie: reglabil de la ± 0,1 la ± 1°C

Cod	Dimensiune	Pret €	Ambalare
957 0155	electronic		1/10



9580
Cronotermostat de ambient
electronic cu touchscreen

CARACTERISTICI TEHNICE:

- Display cu touchscreen
- Alimentare: 2 baterii AAA de 1,5 V
- Durata bateriei: 1 an
- Iesire: in releu, liber de contact 5 A (230 Vac)
- Functie VARA-IARNA-OFF
- Programare saptamanala cu trei nivele de temperatura
- Domeniu de reglare: 2-50°C
- Grad de precizie: reglabil de la ± 0,1 la ± 1°C

Cod	Dimensiune	Pret €	Ambalare
957 0154	electronic		1/10



9567
Servocomanda electrotermica
pentru robinet termostaticabil
de inchidere cu indicator de
cursa.
NORMAL INCHIS

Cod	Dimensiune	Pret €	Ambalare
450 0026	24V		1/20
450 0012	230V		1/20
450 0045	24V		1/20
450 0006	230V		1/20

Versiuni cu microinterruptor auxiliar



9568
Servomotor termoelectric cu
indicare cursa (pentru vane cu
optiune termostatica si colector
din poliamida art.3872POL -
3871PMON)

Cod	Dimensiune	Pret €	Ambalare
450 0543	24V		1/20
450 0539	230V		1/20
450 0545	24V		1/20
450 0541	230V		1/20

Versiuni cu microinterruptor auxiliar

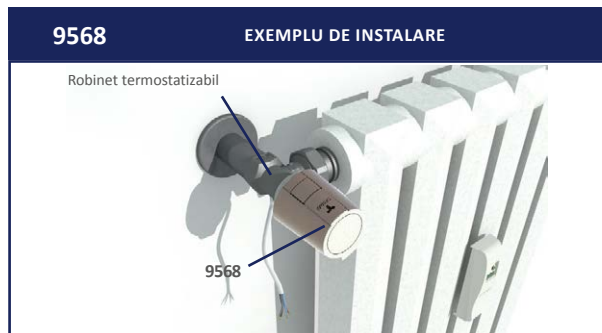

14 TERMOSTATE SI CRONOTERMOSTATE



4625D

Distributor electric cu 10 zone pentru conectarea termostatelor prin fir si a servomotoarelor electrice corespunzatoare, iesire in releu 5(2)A 230 Vac pentru comanda pompei

NOU TATI!



4626D

Distributor electric cu 6 zone pentru conectarea termostatelor prin fir si a servomotoarelor electrice corespunzatoare, iesire in releu 5(2)A 230 Vac pentru comanda pompei

Cod	Dimensiune	Pret €	Ambalare
957 0005	230V		1/6

Echipat cu releu de comutare pentru comanda pompa

Cod	Dimensiune	Pret €	Ambalare
957 0238	230V		1/6

Echipat cu releu de comutare pentru comanda pompa

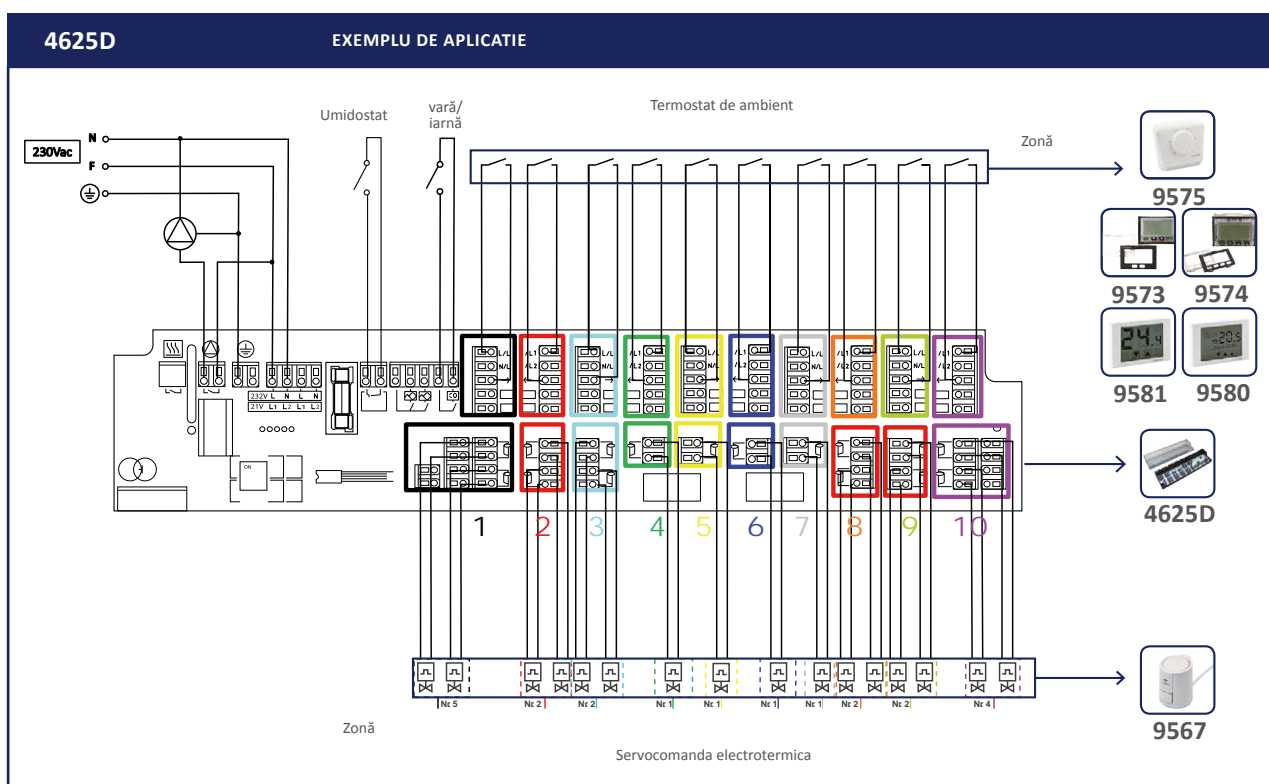



9582U

Umidostat de perete cu display cu touchscreen si alimentare de la retea electrica, pentru reglarea umiditatii in ambientul domestic

CARACTERISTICI TEHNICE:

- Alimentare: 230 Vac (-15% ÷ +10%) 50/60 Hz
- Relee de iesire monostabile 5A/250 Vac
- Tip de reglare: ON/OFF cu diferential fix ±2,5% RH
- Precizie in masurare: ± 5% RH
- Domeniu de reglare: 30% ÷ 90% RH
- Grad de protectie: IP40

Cod	Dimensiune	Pret €	Ambalare
957 0164	electronic		1/10



9583CU

Cronotermostat cu programare saptamanala, cu senzor de umiditate integrat, care regleaza temperatura si controleaza umiditatea ambientului, datorita celor doua relee independente.

CARACTERISTICI TEHNICE:

- Alimentare: 1 baterie alkalina de 1,5V (tip AA)
- Autonomie: un an
- IESIRE:
 - releu bistabil cu contact comutator 5A/ 250Vac (reglare temperatura)
 - releu normal deschis 5A/ 250Vac (reglare umiditate)
- CRONOTERMOSTAT
- Reglarea temperaturii
 - On/Off cu diferential setabil intre 0,1°C si 1°C
 - Proportionala cu banda si perioada de reglare setate
 - Camp reglare temperatura: 2,0°C ÷ +50°C
- Functionare iarna / vara / manuala
- UMIDOSTAT

Functionia umidificare sau dezumidificare selectabila

Reglare ON/OFF cu diferential setabil intre 5% RH si 20% RH

- Precizie in masurare: ± 5% RH
- Domeniu de reglare: 30% ÷ 90% RH

Cod	Dimensiune	Pret €	Ambalare
957 0165	alba		1/6



**4601**

Termostat de ambient electronic cu transmisie via radio

CARACTERISTICI TEHNICE:

- Display cu touchscreen
- Alimentare: 2 baterii AAA de 1,5 V
- Durata bateriei: 1 an
- Frecventa de transmisie: 433,92 MHz
- Functie VARA-IARNA-OFF
- Domeniu de reglare: 2-50°C
- Grad de precizie: reglabil de la +0,1 la +1°C

Cod	Dimensiune	Pret €	Ambalare
957 0156	electronic		1/10

**9580W**

Cronotermostat de ambient electronic cu touchscreen cu transmisie via radio

CARACTERISTICI TEHNICE:

- Display cu touchscreen
- Alimentare: 2 baterii AAA de 1,5 V
- Durata bateriei: 1 an
- Frecventa de transmisie: 433,92 MHz
- Functie VARA-IARNA-OFF
- Programare saptamanala cu trei nivele de temperatura
- Domeniu de reglare: 2-50°C
- Grad de precizie: reglabil de la +0,1 la +1°C

Cod	Dimensiune	Pret €	Ambalare
957 0172	electronic		1/10

**4606**

Sistem pentru termoreglare via radio compus din termostat de ambient electronic cu touchscreen + receptor cu un canal

CARACTERISTICI TEHNICE:**TERMOSTAT**

- Vezi caracteristici tehnice art. 4601

RECEPTOR:

- Vezi caracteristici tehnice art. 4607

Cod	Dimensiune	Pret €	Ambalare
957 0157	electronic		1/4

**4607**

Receptor radio cu 1 canal cu comanda pentru centrala/pompa de caldura/pompa circulatie

CARACTERISTICI TEHNICE

- Alimentare: 230 Vac 50 Hz
- Versiune 2 module DIN
- Iesire: releu de comutare fara tensiune 8 A (230 Vac)

Cod	Dimensiune	Pret €	Ambalare
957 0183	electronic		1/25

**4612**

Receptor radio cu 6 canale cu comanda pentru capete electrotermice 9567

CARACTERISTICI TEHNICE:

- Alimentare: 230 Vac 50 Hz
- N° canale: 6
- Comanda capete electrotermice: releu de contact 5 A (230 Vac)
- Comanda pompa: releu de contact 5 A (230 Vac)
- Intarziere comanda pompa setabila de la 3 secunde la 5 minute
- Antena externa inclusa
- Versiune 4 module DIN

Cod	Dimensiune	Pret €	Ambalare
957 0158	electronic		1/4

**9556W**

Cap termostatic electronic programabil wireless. Interval de temperatura 8-28 °C

Cod	Dimensiune	Pret €	Ambalare
955 0027	M30 x 1,5		1/5

4601-4612-9567

EXEMPLU DE INSTALARE

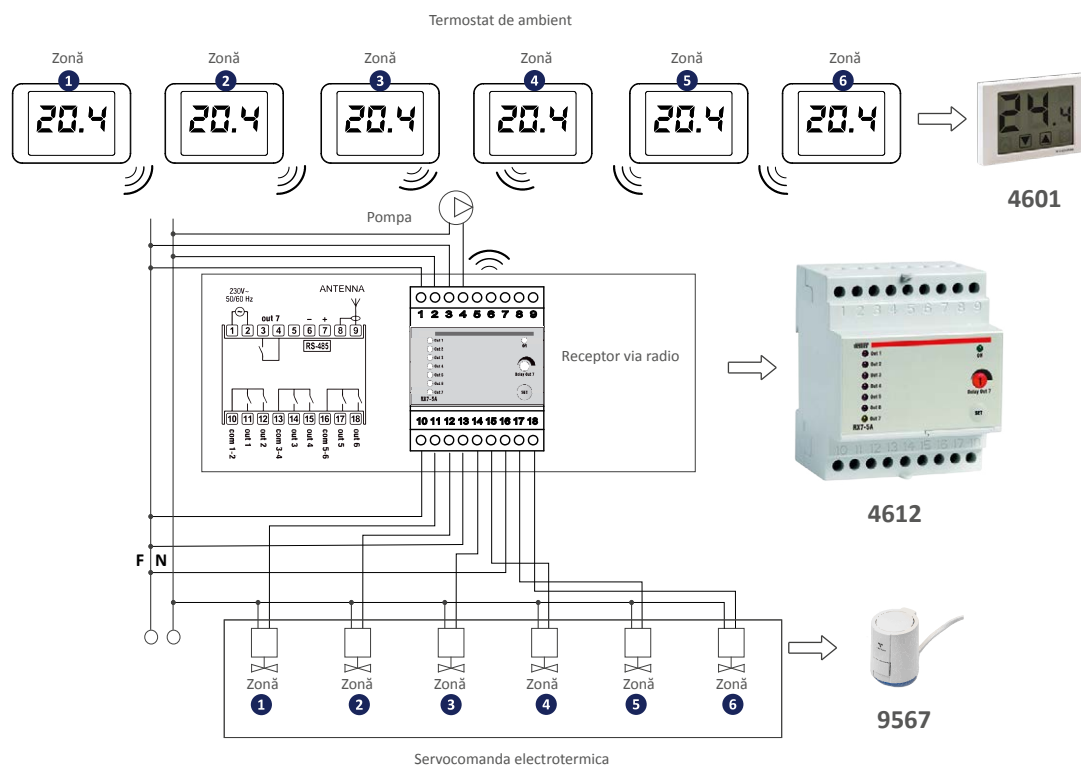

9556W-4601-9580W

EXEMPLU DE INSTALARE



14 SISTEME DE TERMOREGLARE WI-FI

TIEMME GATE



9564W

Cap termostatic electronic comunicare Wi-Fi. Sistemul „Tiemme GATE”. Domeniu de temperatura 6-28o C

CARACTERISTICI TEHNICE:

- Alimentarea: nr. 2 baterii 1,5 V tip AA
- Funcționarea: ON, OFF, manuală, în regim automat
- Domeniu de reglare: +6oC÷28oC
- Tip conexiune: M30 x 1,5
- Adaptorii pentru toate tipurile de robineti uzuali prezenti pe piata
- Banda de frecvență Wi-Fi: 2,4 GHz
- Clasa: VIII (cu o comanda OpenTherm - releu 9564RS) IV (cu o comanda ON/OFF - releu 9564RS)

Cod	Dimensiune	Pret €	Ambalare
955 0052	M30 x 1,5		1/4



9564ST

Sonda de temperatură cu Wi-Fi. Sistemul „TIEMME GATE”

CARACTERISTICI TEHNICE:

- Alimentarea: nr. 2 baterii 1,5 V tip AA
- Domeniu de reglare: 0 °C ÷ +50 °C
- Banda de frecvență Wi-Fi: 2,4 GHz

Cod	Dimensiune	Pret €	Ambalare
955 0053	0 °C ÷ + 50 °C		1/10



9564RS

Releu cu Wi-Fi. Sistemul „TIEMME GATE”

CARACTERISTICI TEHNICE:

- Alimentarea: 85 ÷ 230 Vac 50/60 Hz
- Iesire releu de contact: 5 A 230 V
- Control tip “OpenTherm” catre centrala termica
- Banda de frecvență cu Wi-Fi: 2,4 GHz

Cod	Dimensiune	Pret €	Ambalare
955 0054	-		1/10



Disponibil pentru



9564W-9564ST-9564RS EXEMPLU DE INSTALARE

SISTEM CENTRALIZAT

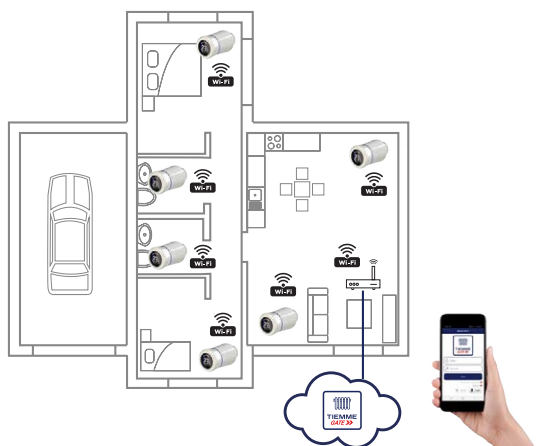

SISTEM AUTONOM

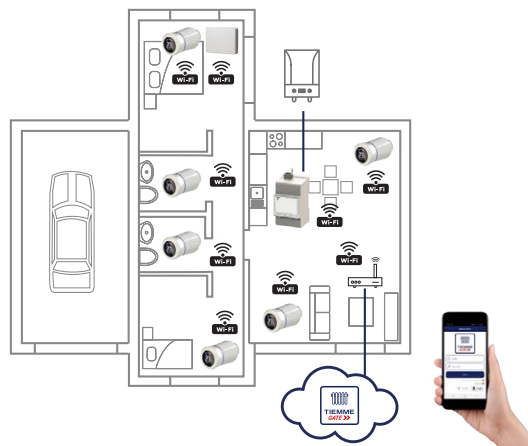

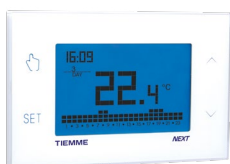

9589

Cronotermostat de perete săptămânal **TIEMME NEXT** culoare alb. Comunicare prin Wi-Fi.

CARACTERISTICI TEHNICE

- Alimentare: 230Vac ± 10% 50/60 Hz / 4 baterii de 1,5V (tip AA)
- Ieșire: releu de comutare fără tensiune de 5 A (250 Vac)
- Funcție iarna / vara / oprit
- Programare: Săptămânal cu 3 niveluri de temperatură (T1 - T2 - T3)
- Domeniu de reglare: 2,0 ÷ 50,0 °C
- Reglarea temperaturii: ON/OFF cu diferential reglabil (0,1 ÷ 1,0 °C) sau proporțional cu banda reglabila
- Modul Wi-Fi pentru conectarea cu aplicația TIEMME NEXT
- Montaj: Pe perete 130 x 85 grosime 28 mm

Cod	Dimensiune	Pret €	Ambalare
957 0201	230 Vac		1/10
957 0211	4 x 1,5 V AA		1/10

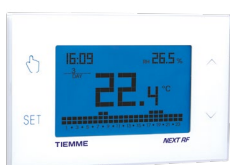

9590

Cronotermostat săptămânal de perete cu senzor de umiditate **TIEMME NEXT RF** de culoare albă. Comunicare prin Wi-Fi și RF (frecvență radio).

CARACTERISTICI TEHNICE

- Alimentare: 230Vac ± 10% 50/60 Hz
- Funcție iarna / vara / oprit
- Programare: Săptămânal cu 3 niveluri de temperatură (T1 - T2 - T3)
- Domeniu de reglare: 2,0 ÷ 50,0 °C
- Reglarea temperaturii: ON / OFF cu diferential reglabil (0,1 ÷ 1,0 °C) sau proporțional cu bandă reglabila
- Modul Wi-Fi pentru conectarea cu aplicația TIEMME NEXT
- Modul de radiofrecvență pentru gestionarea a 3 comenzi (Temperatura/Umiditate/VMC)
- Banda de frecvență: 433,92 MHz
- Montaj: Pe perete 130 x 85 grosime 28 mm

Cu senzor de umiditate

Cu modul de radiofrecvență integrat pentru comunicare cu receptorul radio art. 4607 - 4612 sau cap termostatic art. 9556W

Cod	Dimensiune	Pret €	Ambalare
957 0203	230 Vac		1/10



9591

Cronotermostat săptămânal pentru montaj încastrat (cutie dreptunghiulară) **TIEMME NEXT IN**. Comunicare Wi-Fi

CARACTERISTICI TEHNICE

- Alimentare: 230Vac ± 10% 50/60 Hz
- Ieșire: releu de comutare fără tensiune de 5 A (250 Vac)
- Funcție iarna / vara / oprit
- Programare: Săptămânal cu 3 niveluri de temperatură (T1 - T2 - T3)
- Domeniu de reglare: 2,0 ÷ 50,0 °C
- Reglarea temperaturii: ON / OFF cu diferential reglabil (0,1 ÷ 1,0 °C) sau proporțional cu bandă reglabila
- Modul Wi-Fi pentru conectarea cu aplicația TIEMME NEXT
- Instalare: încastrat (2 module) în seria principală casnică (Bticino, Vimar, Ave, Gewiss)

Cod	Dimensiune	Pret €	Ambalare
957 0205	230 Vac		1/5



9592

Cronotermostat săptămânal încastrat (cutie rotundă) **TIEMME NEXT RD**. Comunicare Wi-Fi

CARACTERISTICI TEHNICE

- Alimentare: 230Vac ± 10% 50/60 Hz
- Ieșire: releu de comutare fără tensiune de 5 A (250 Vac)
- Funcție iarna / vara / oprit
- Programare: Săptămânal cu 3 niveluri de temperatură (T1 - T2 - T3)
- Domeniu de reglare: 2,0 ÷ 50,0 °C
- Reglarea temperaturii: ON / OFF cu diferential reglabil (0,1 ÷ 1,0 °C) sau proporțional cu bandă reglabila
- Modul Wi-Fi pentru conectarea cu aplicația TIEMME NEXT
- Instalare: încastrat (distanța centrală a cutiei rotunde 60 mm)

Cod	Dimensiune	Pret €	Ambalare
957 0207	230 Vac		1/5



Disponibil pentru



LISTA DE PREȚURI



2075
Termostat cu contact reglabil

CARACTERISTICI TEHNICE

- Domeniu de reglare: 0-90°C
- Ieșire: contact liber de tensiune 16(4) A/250 Vac-6(1) A/400 Vacc
- Grad de protecție: IP40
- Diferențial: $6 \pm 2^\circ\text{C}$
- Arc de fixare inclus

Cod	Dimensiune	Pret €	Ambalare
957 0001	0/90°C		1/20



2076
Termostat de imersie reglabil

CARACTERISTICI TEHNICE

- Contine izolatia cu prindere de 1/2"
- Domeniu de reglare: 0-90°C
- Ieșire: contact liber de tensiune 16(4) A/250 Vac-6(1) A/400 Vac
- Grad de protecție: IP40
- Diferențial: $6 \pm 2^\circ\text{C}$

Cod	Dimensiune	Pret €	Ambalare
957 0003	0/90°C - 1/2"		1/10



2077
Termostat de imersie cu reglare fixa

CARACTERISTICI TEHNICE

- Inclusiv stut cu racord de 1/2"
- Temperatura de intervenție: $96 \pm 3^\circ\text{C}$
- Ieșire: contact de întrerupere 16 (2,5) A / 250 Vac
- Grad de protecție: IP40
- Diferențial: $4 \pm 2^\circ\text{C}$
- Rearmare manuală

Cod	Dimensiune	Pret €	Ambalare
957 0016	96°C - 1/2"		1/10



2078
Termostat de imersie cu actiune dubla: reglare fixa si posibilitate de reglare

CARACTERISTICI TEHNICE

- Inclusiv stut cu racord de 1/2"
- Interval de reglare: 30-90 °C
- Temperatura de intervenție: $96 \pm 3^\circ\text{C}$
- Ieșire de reglare: contacte comutatoare fără tensiune 16 (4) A / 250 Vac
- Ieșire de calibrare fixă: contact de întrerupere 16 (2,5) A / 250 Vac
- Grad de protecție: IP40
- Diferențial: $4 \pm 2^\circ\text{C}$
- Rearmare manuală

Cod	Dimensiune	Pret €	Ambalare
957 0010	30/90°C - 96°C 1/2"		1/5

15 COMPONENTE PENTRU CENTRALE TERMICE/INCALZIRE



























INAIL



TSU

EAC



Supape de siguranta		322
Grup de siguranta		324
Manometru si termomanometru		325
Supape limitare presiune		326
Distribuitor preasamblat cu elemente de masura si control INAIL		327
Presostate și termostate de siguranță		328
Supape de siguranta pentru boiler		328
Grupuri de incarcare		329
Colectori de distributie si separatoare de otel din centrala termica		330
Colectoare de distributie din alama pentru centrala termica		331
Accesorii pentru colectoare de distributie din alama pentru centrala termica		338
Grupuri de pompare		339
Accesorii pentru grupuri de pompare		342
Filtre magnetice de separare a murdăriei		344
Dozator proportional al cristalelor de polifosfati		346
Supape de aerisire		346
Modul hidronic		349
Vana deviatie/amestec		350
Ventil termic amestec anticondens		351
Robinete de echilibrare		351
Filtre cu autocuratare		359
Filtre Y		361
Reductoare de presiune		362
Vane de amestec termostatic		364
Kit termostatic anti-oparire cu recirculare		365
Amortizor lovitura de berbec		366
Vana anti-retur		367



1917 1927

Supapa de siguranta F/F

CARACTERISTICI TEHNICE:

- Temperatura minima de exercitiu: -5°C
- Temperatura maxima de exercitiu: 120°C
- Presiune nominala: PN10
- Corp: din alama CW 617N
- Marja de deschidere: 10%
- Filete interioare: F ISO 228

Cod	Dimensiune	Tarare	Pret €	Ambalare
192 0013	1/2" x 1/2"	1,5 bar		1/40
192 0033	1/2" x 1/2"	1,8 bar		1/40
192 0025	1/2" x 1/2"	2 bar		1/40
192 0008	1/2" x 1/2"	2,5 bar		1/40
192 0001	1/2" x 1/2"	3 bar		1/40
192 0060	1/2" x 1/2"	3,5 bar		1/40
192 0010	1/2" x 1/2"	4 bar		1/40
192 0053	1/2" x 1/2"	5 bar		1/40
192 0006	1/2" x 1/2"	6 bar		1/40
192 0022	1/2" x 1/2"	7 bar		1/40
192 0035	1/2" x 1/2"	8 bar		1/40
192 0011	1/2" x 1/2"	9 bar		1/40
192 0018	1/2" x 1/2"	10 bar		1/40
192 0014	3/4" x 3/4"	1,5 bar		1/40
192 0027	3/4" x 3/4"	1,8 bar		1/40
192 0034	3/4" x 3/4"	2 bar		1/40
192 0012	3/4" x 3/4"	2,5 bar		1/40
192 0003	3/4" x 3/4"	3 bar		1/40
192 0054	3/4" x 3/4"	3,5 bar		1/40
192 0015	3/4" x 3/4"	4 bar		1/40
192 0071	3/4" x 3/4"	5 bar		1/40
192 0007	3/4" x 3/4"	6 bar		1/40
192 0036	3/4" x 3/4"	7 bar		1/40
192 0030	3/4" x 3/4"	8 bar		1/40
192 0043	3/4" x 3/4"	9 bar		1/40
192 0031	3/4" x 3/4"	10 bar		1/40
192 0072	1" x 1"	1,5 bar		1/25
192 0073	1" x 1"	1,8 bar		1/25
192 0074	1" x 1"	2 bar		1/25
192 0075	1" x 1"	2,5 bar		1/25
192 0004	1" x 1"	3 bar		1/25
192 0076	1" x 1"	3,5 bar		1/25

1917-1927 - Supapa de siguranta F/F

Cod	Dimensiune	Tarare	Pret €	Ambalare
192 0023	1" x 1"	4 bar		1/25
192 0077	1" x 1"	5 bar		1/25
192 0009	1" x 1"	6 bar		1/25
192 0016	1" x 1"	7 bar		1/25
192 0026	1" x 1"	8 bar		1/25



1918 1928

Supapa de siguranta M/F

CARACTERISTICI TEHNICE:

- Temperatura minima de exercitiu: -5°C
- Temperatura maxima de exercitiu: 120°C
- Presiune nominala: PN10
- Corp: din alama CW 617N
- Marja de deschidere: 10%
- Filete interioare: F ISO 228

Cod	Dimensiune	Tarare	Pret €	Ambalare
192 0052	1/2" x 1/2"	1,5 bar		1/40
192 0078	1/2" x 1/2"	1,8 bar		1/40
192 0045	1/2" x 1/2"	2 bar		1/40
192 0041	1/2" x 1/2"	2,5 bar		1/40
192 0002	1/2" x 1/2"	3 bar		1/40
192 0055	1/2" x 1/2"	3,5 bar		1/40
192 0020	1/2" x 1/2"	4 bar		1/40
192 0059	1/2" x 1/2"	5 bar		1/40
192 0005	1/2" x 1/2"	6 bar		1/40
192 0029	1/2" x 1/2"	7 bar		1/40
192 0037	1/2" x 1/2"	8 bar		1/40
192 0050	1/2" x 1/2"	9 bar		1/40
192 0038	1/2" x 1/2"	10 bar		1/40
192 0086	1" x 1"	1,5 bar		1/25
192 0087	1" x 1"	1,8 bar		1/25
192 0088	1" x 1"	2 bar		1/25
192 0089	1" x 1"	2,5 bar		1/25
192 0090	1" x 1"	3 bar		1/25
192 0091	1" x 1"	3,5 bar		1/25
192 0092	1" x 1"	4 bar		1/25
192 0093	1" x 1"	5 bar		1/25
192 0102	1" x 1"	6 bar		1/25
192 0019	1" x 1"	7 bar		1/25
192 0024	1" x 1"	8 bar		1/25





1917M 1927M

Supapa de siguranta F/F ISO 7

CARACTERISTICI TEHNICE:

- Temperatura minima de exercitiu: -5°C
- Temperatura maxima de exercitiu: 120°C
- Presiune nominala: PN10
- Corp: din alama CW 617N
- Marja de deschidere: 10%
- Filete interioare: F ISO 7

+ IESIRE MARITA

Cod	Dimensiune	Tarare	Pret €	Ambalare
192 0066	1/2" x 3/4"	1,5 bar		1/40
192 0067	1/2" x 3/4"	1,8 bar		1/40
192 0048	1/2" x 3/4"	2 bar		1/40
192 0042	1/2" x 3/4"	2,5 bar		1/40
192 0040	1/2" x 3/4"	3 bar		1/40
192 0068	1/2" x 3/4"	3,5 bar		1/40
192 0069	1/2" x 3/4"	4 bar		1/40
192 0070	1/2" x 3/4"	5 bar		1/40
192 0039	1/2" x 3/4"	6 bar		1/40
192 0057	1/2" x 3/4"	7 bar		1/40
192 0096	1/2" x 3/4"	8 bar		1/40
192 0097	1/2" x 3/4"	9 bar		1/40
192 0098	1/2" x 3/4"	10 bar		1/40



1917MAN 1927MAN

Supapa de siguranta F/F cu iesire manometru

CARACTERISTICI TEHNICE:

- Temperatura minima de exercitiu: -5°C
- Temperatura maxima de exercitiu: 120°C
- Presiune nominala: PN10
- Corp: din alama CW 617N
- Marja de deschidere: 10%
- Filete interioare: F ISO 228

+ CU RACORD MANOMETRU

i Accesorii: Termometru art. 2080POST pag.325

Cod	Dimensiune	Tarare	Pret €	Ambalare
192 0061	1/2" x 1/2"	1,5 bar		1/40
192 0062	1/2" x 1/2"	1,8 bar		1/40
192 0063	1/2" x 1/2"	2 bar		1/40
192 0046	1/2" x 1/2"	2,5 bar		1/40
192 0028	1/2" x 1/2"	3 bar		1/40
192 0064	1/2" x 1/2"	3,5 bar		1/40
192 0044	1/2" x 1/2"	4 bar		1/40
192 0065	1/2" x 1/2"	5 bar		1/40
192 0058	1/2" x 1/2"	6 bar		1/40
192 0051	1/2" x 1/2"	7 bar		1/40
192 0094	1/2" x 1/2"	8 bar		1/40
192 0095	1/2" x 1/2"	9 bar		1/40
192 0056	1/2" x 1/2"	10 bar		1/40



**1918MAN
1928MAN**
Supapa de siguranta M/F cu
iesire manometru

CARACTERISTICI TEHNICE:

- Temperatura minima de exercitiu: -5°C
- Temperatura maxima de exercitiu: 120°C
- Presiune nominala: PN10
- Corp: din alama CW 617N
- Marja de deschidere: 10%
- Filete interioare: F ISO 228

CU RACORD MANOMETRU

i Accesorii: Manometru art. 2080POST pag. 325

Cod	Dimensiune	Tarare	Pret €	Ambalare
192 0079	1/2" x 1/2"	1,5 bar		1/40
192 0080	1/2" x 1/2"	1,8 bar		1/40
192 0081	1/2" x 1/2"	2 bar		1/40
192 0082	1/2" x 1/2"	2,5 bar		1/40
192 0032	1/2" x 1/2"	3 bar		1/40
192 0083	1/2" x 1/2"	3,5 bar		1/40
192 0084	1/2" x 1/2"	4 bar		1/40
192 0085	1/2" x 1/2"	5 bar		1/40
192 0049	1/2" x 1/2"	6 bar		1/40
192 0047	1/2" x 1/2"	7 bar		1/40
192 0099	1/2" x 1/2"	8 bar		1/40
192 0100	1/2" x 1/2"	9 bar		1/40
192 0101	1/2" x 1/2"	10 bar		1/40



1916
Supapa de siguranta M de
temperatura si presiune pentru
teava cupru

CARACTERISTICI TEHNICE:

- Temperatura de exercitiu: între 90 și 95°C
- Presiune de exercitiu: 3-4-6-7 bar
- Presiune nominala PN 10
- Fluid: apa
- Material corp: alama CW 617N UNI EN 12165
- Conform Normei europene EN 1490 si Directivei 97/23/CE (PED)

CONTROL TEMPERATURA-PRESIUNE

Cod	Dimensiune	Tarare	Pret €	Ambalare
192 0106	1/2" x 15	3 bar		1/10
192 0107	1/2" x 15	4 bar		1/10
192 0108	1/2" x 15	6 bar		1/10
192 0109	1/2" x 15	7 bar		1/10
192 0111	3/4" x 15	3 bar		1/10
192 0112	3/4" x 15	4 bar		1/10
192 0113	3/4" x 15	6 bar		1/10
192 0114	3/4" x 15	7 bar		1/10
192 0116	3/4" x 22	3 bar		1/10
192 0117	3/4" x 22	4 bar		1/10
192 0118	3/4" x 22	6 bar		1/10
192 0119	3/4" x 22	7 bar		1/10

Pentru încălzitorul de apă



**3177
3177X**
Grup de siguranta pentru boiler
si acumulator acm

Cod	Dimensiune	Tarare	Pret €	Ambalare
319 0013	3/4" x 3/4"	7 bar		1/20
319 0014	3/4" x 3/4"	7 bar		1/20

Scaun (supapă de siguranță) alama

Scaun (supapă de siguranță) din oțel inoxidabil



15 GRUP DE SIGURANTA

Pentru centrale (cazane) pe lemne



3175CT
Grup de siguranta izolat pt. centrale pe lemne

Cod	Dimensiune	Pret €	Ambalare
319 0010	1" - 1,5 bar		1/5
319 0021	1" - 2,5 bar		1/5
319 0009	1" - 3 bar		1/5

TUTORIAL VIDEO



Grup de siguranta cu izolatie pentru cazane pe lemne - Principiu de functionare



3175ISOL
Grup de siguranta izolat pentru centrale pe lemne

Cod	Dimensiune	Pret €	Ambalare
319 0003	1" - 1,5 bar		1/5
319 0001	1" - 3 bar		1/5

15 MANOMETRU SI TERMOMANOMETRU



2080POST
Manometru cu atac posterior



Cod	Dimensiune	Scara	Pret €	Ambalare
192 0021	1/4"	0 - 4 bar		1/40
192 0017	1/4"	0 - 10 bar		1/40

Pentru supape tarate pana la 3 bar



2080
Manometru cu prindere radiala DN50

Cod	Dimensiune	Scara	Pret €	Ambalare
318 0007	1/4"	0 - 6 bar		5/25
318 0025	1/4"	0 - 16 bar		5/25



2081
Termomanometru 0-120°C/0-6 bar

Cod	Dimensiune	Pret €	Ambalare
208 0001	1/4" (1/2")		1/30



19210M

Supapa limitare presiune unghiulara cu racord cu filet interior/interior si evacuare directionata, care poate fi calibrata la 0÷16 bar, cu obturator din metal

CARACTERISTICI TEHNICE:

- Temperatura minima de exercitiu: 5°C
- Temperatura maxima de exercitiu: 200°C
- Presiune nominala: PN16 (de 3/8" a 2")- PN10 (de 2"½ a 3")
- Corp: CW 617N brass
- Marja de deschidere: 20%
- Filete interioare: F ISO 228

Cod	Dimensiune	Pret €	Ambalare
196 0001	3/8"		12/48
196 0002	1/2"		10/40
196 0003	3/4"		7/28
196 0004	1"		4/16
196 0005	1"1/4		2/8
196 0006	1"1/2		1/4
196 0007	2"		1/4
196 0008	2"1/2		1/1
196 0009	3"		1/1



19210G

Supapa limitare presiune unghiulara cu racord cu filet interior/interior si evacuare directionata, care poate fi calibrata la 0÷16 bar, cu obturator din cauciuc (SBR)

CARACTERISTICI TEHNICE:

- Temperatura minima de exercitiu: 5°C
- Temperatura maxima de exercitiu: 70°C
- Presiune nominala: PN16 (de 3/8" a 2")- PN10 (de 2"½ a 3")
- Corp: CW 617N brass
- Marja de deschidere: 20%
- Filete interioare: F ISO 228

Cod	Dimensiune	Pret €	Ambalare
196 0019	3/8"		12/48
196 0020	1/2"		10/40
196 0021	3/4"		7/28
196 0022	1"		4/16
196 0023	1"1/4		2/8
196 0024	1"1/2		1/4
196 0025	2"		1/4
196 0026	2"1/2		1/1
196 0027	3"		1/1



19210P

Supapa limitare presiune unghiulara cu racord cu filet interior/interior si evacuare directionata, care poate fi calibrata la 0÷16 bar, cu obturator din PTFE

CARACTERISTICI TEHNICE:

- Temperatura minima de exercitiu: 5°C
- Temperatura maxima de exercitiu: 180°C
- Presiune nominala: PN16 (de 3/8" a 2")- PN10 (de 2"½ a 3")
- Corp: CW 617N brass
- Marja de deschidere: 20%
- Filete interioare: F ISO 228

Cod	Dimensiune	Pret €	Ambalare
196 0037	3/8"		12/48
196 0038	1/2"		10/40
196 0039	3/4"		7/28
196 0040	1"		4/16
196 0041	1"1/4		2/8
196 0042	1"1/2		1/4
196 0043	2"		1/4
196 0044	2"1/2		1/1
196 0045	3"		1/1



**7169**

Distribuitor cu preasamblat cu elemente de masura si control

CARACTERISTICI TEHNICE:

- Corp colector: oțel ST195 vopsit
- Racorduri principale: filetat cu olandezi 1"1/4, 1"1/2, 2" și flansa (PN16) DN50, DN65 și DN80
- Fluid utilizat: apă și glicol (procentaj maxim 30%)
- P_{max} de exercițiu: 10 bar
- Gama de temperatura: 0 ÷ 110°C

Cod	Dimensiune	Pret €	Ambalare
321 0001	1"1/4		1/1
321 0002	1"1/2		1/1
321 0003	2"		1/1
321 0004	DN50		1/1
321 0005	DN65		1/1
321 0006	DN80		1/1

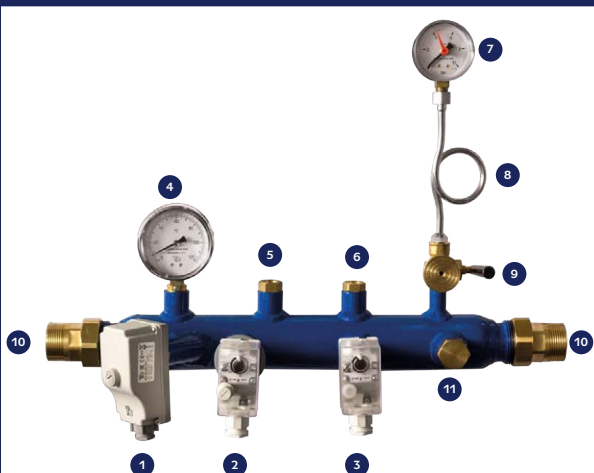
7169**CONFIGURATIE**

1. Termostat de imersie
2. Presostat de siguranta cu re-armare manula
3. Presostat de minim cu re-armare manuala
4. Termometru
5. Stut pentru vana de control a alimentarii cu combustibil
6. Stut pentru control
7. Manometru
8. Sifon de amortizare pentru temperaturi inalte
9. Robinet pentru manometru
10. Racorduri
11. Racord disponibil pentru conectarea supapei de siguranta INAIL

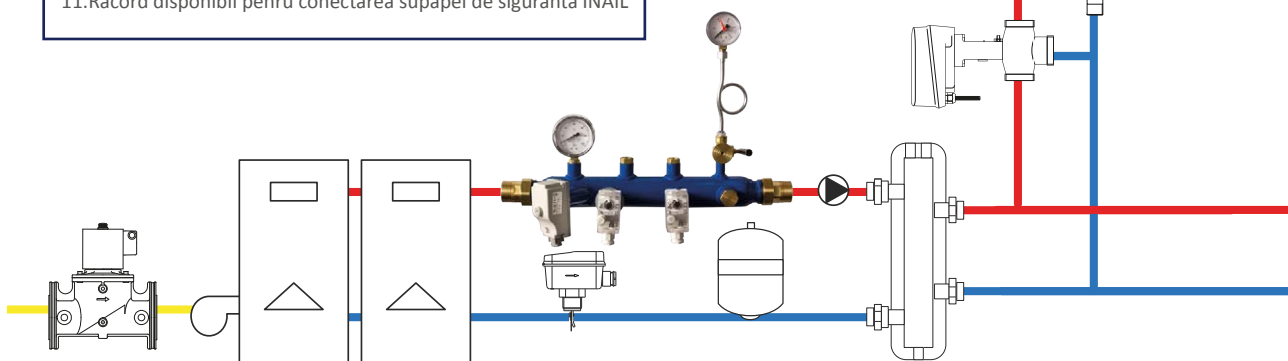
**1923**

Robinet pentru manometru cu racord cu filet exterior/interior cu presetupa și dren. Mâner din rasina termoplastica

Cod	Dimensiune	Pret €	Ambalare
199 0007	1/4"		15/60
199 0008	3/8"		10/40
199 0009	1/2"		5/20

**1923FL**

Robinet pentru manometru cu racord cu filet exterior/interior cu blocare de siguranta, flansa și capac flansa. Mâner din rasina termoplastica

Cod	Dimensiune	Pret €	Ambalare
199 0001	1/4"		15/60
199 0002	3/8"		10/40
199 0003	1/2"		5/20

**1924**

Serpentina pentru manometru cu racord cu filet exterior fix, capac rotativ și teava de cupru Ø 8 mm

Cod	Dimensiune	Pret €	Ambalare
178 0001	1/4"		10/40
178 0002	3/8"		10/40
178 0003	1/2"		10/40

**2074MIN**

Comutator al presiunii minime
cu resetare manuala, IP44

Cod	Dimensiune	Pret €	Ambalare
075 0069	0,5 ÷ 2,5 Bar		1/18

**2074MAX**

Comutator al presiunii maxime
cu resetare manuala, IP44

Cod	Dimensiune	Pret €	Ambalare
075 0068	2 ÷ 5,5 Bar		1/18

**2079**

Presostat pentru instalatii
hidro-sanitare

Cod	Dimensiune	Pret €	Ambalare
075 0022	1 - 5 Bar		1/50
075 0041	3 - 12 Bar		1/15

**2079-3V**

Presostat monofazat Racord cu 3
căi Manometru apă

Cod	Dimensiune	Pret €	Ambalare
075 0001	1 - 5 Bar		1/30

**2079INV**

Presostat de protectie inversa
pentru sisteme hidraulice si
pneumatice

Cod	Dimensiune	Pret €	Ambalare
075 0070	1 - 5 Bar		1/50

**1919**

Supapa de siguranta pentru
boiler

CARACTERISTICI TEHNICE:

- Temperatura maxima de exercitiu: 120°C
- Presiune nominala: PN10
- Corp: din alama CW 617N
- Filete interioare: M/F ISO 228

Cod	Dimensiune	Taratura	Pret €	Ambalare
193 0002	1/2"	8,5 bar		5/50

**1929**

Supapa de siguranta pentru
boiler cu "maneta"

CARACTERISTICI TEHNICE:

- Temperatura maxima de exercitiu: 120°C
- Presiune nominala: PN10
- Corp: din alama CW 617N
- Filete interioare: M/F ISO 228

Cod	Dimensiune	Taratura	Pret €	Ambalare
193 0001	1/2"	8,5 bar		5/50





3160GN
Grup de incarcare automat

CARACTERISTICI TEHNICE:

- Domeniu de reglare: 1-6 bar (Setare din fabrică 1,5 bar)
- Presiune maxima in amonte: 16 bar
- Temperatura maxima de exercitiu: 65°C
- Corp: din alama CW 617N
- Intrare: olandez 1/2" M ISO 228
- Iesire: 1/2" F ISO 228
- Iesire manometru: 1/4" F
- Livrat cu manometru

Cod	Dimensiune	Pret €	Ambalare
317 0030	1/2"		1/10



3161
Grup de incarcare automat cu 2 robineti de izolare si manometru pentru instalatiile de incalzire cu circuit inchis

CARACTERISTICI TEHNICE:

- Interval de reglare: 1-6 bar (setare din fabrică 1,5 bar)
- Presiune maximă de intrare: 16 bar
- Temperatura maxima de lucru: 65°C
- Material corp: alama CW617N
- Racord manometru: 1/4" F
- Se livreaza cu manometru

Cod	Dimensiune	Pret €	Ambalare
317 0007	1/2"		1/8
317 0008	3/4"		1/8



3180C
Cartus de înlocuire pentru reductor de presiune Art. 3180 si grup de incarcare automat Art. 3160GN - 3161

Cod	Dimensiune	Pret €	Ambalare
318 0053	3180/ 3160GN/3161		1/40



3170
Grup de alimentare cu antigel

CARACTERISTICI TEHNICE:

- Temperatura minima de exercitiu: -20°C
- Temperatura maxima de exercitiu: +100°C
- Presiune maxima de exercitiu: 10 bar
- Corp: din alama CW 617N
- Legaturi linie principala: 1" M ISO 228
- Legaturi pentru antigel: 3/4" M ISO 228
- Contine filtre de 350 µm
- Livrat cu izolatie in polistiren expandat (EPS)

Cod	Dimensiune	Pret €	Ambalare
317 0002	1"		1/2

3170 FUNCTIONARE

FUNCTIONARE NORMALA

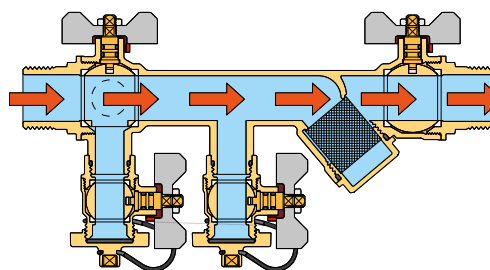

FUNCTIONARE IN CONTINUU

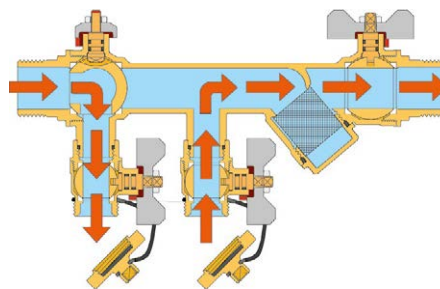

**3165**

Butelie de egalizare

CARACTERISTICI TEHNICE:

- Material corp: oțel Fe 360 vopsit cu pulberi epoxidice
- Presiune maximă de lucru: 10 bar
- Temperatura maxima de lucru: 110°C

i Transformabil in varianta magnetica cu ajutorul accesoriului 3144MAG

Cod	Dimensiune	Debit max	Pret €	Ambalare
316 0006	1"	2,5 (m³/h)		1/1
316 0003	1"1/4	4,0 (m³/h)		1/1
316 0004	1"1/2	6,0 (m³/h)		1/1
316 0005	2"	9,0 (m³/h)		1/1

**3165ISOL**

Butelie de egalizare cu izolație în polistiren expandat

CARACTERISTICI TEHNICE:

- Material corp: oțel Fe 360 vopsit cu pulberi epoxidice
- Material izolație: PE-X expandat cu celule închise
- Presiune maximă de lucru: 10 bar
- Temperatura maxima de lucru: 100°C

i Transformabil in varianta magnetica cu ajutorul accesoriului 3144MAG.

Cod	Dimensiune	Debit max	Pret €	Ambalare
316 0001	1"	2,5 (m³/h)		1/1
316 0002	1"1/4	4,0 (m³/h)		1/1
316 0008	1"1/2	6,0 (m³/h)		1/1
316 0007	2"	9,0 (m³/h)		1/1

**3144**

Butelie de egalizare echipata cu kit magnetic

**CARACTERISTICI TEHNICE:**

- Material corp: oțel Fe 360 vopsit cu pulberi epoxidice
- Presiune maximă de lucru: 10 bar
- Temperatura maxima de lucru: 110°C

Cod	Dimensiune	Debit max	Pret €	Ambalare
314 0001	1"	2,5 (m³/h)		1/1
314 0002	1"1/4	4,0 (m³/h)		1/1
314 0003	1"1/2	6,0 (m³/h)		1/1
314 0004	2"	9,0 (m³/h)		1/1

**3144ISOL**

Butelie de egalizare echipata cu kit magnetic și izolație polistiren expandat

**CARACTERISTICI TEHNICE:**

- Material corp: oțel Fe 360 vopsit cu pulberi epoxidice
- Material izolație: PE-X expandat cu celule închise
- Presiune maximă de lucru: 10 bar
- Temperatura maxima de lucru: 100°C

Cod	Dimensiune	Debit max	Pret €	Ambalare
314 0005	1"	2,5 (m³/h)		1/1
314 0006	1"1/4	4,0 (m³/h)		1/1
314 0007	1"1/2	6,0 (m³/h)		1/1
314 0008	2"	9,0 (m³/h)		1/1

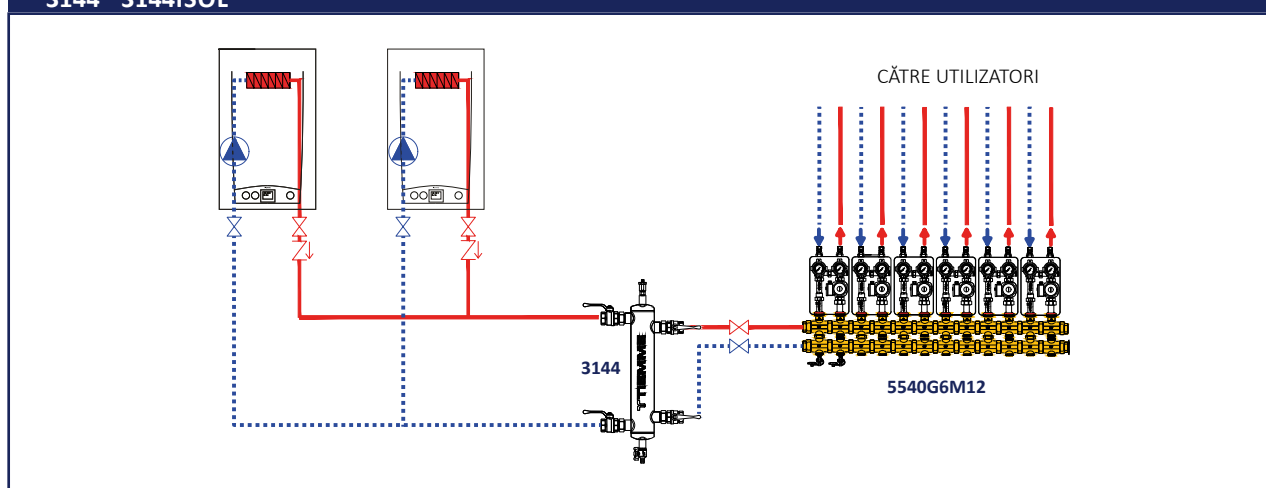
**3165 - 3165ISOL
3144 - 3144ISOL****EXEMPLU DE INSTALARE**

**3144MAG**

Kit magnetic

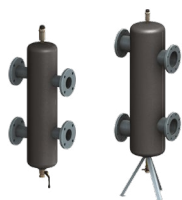

Cod	Dimensiune	Pret €	Ambalare
316 0105	1/2"		1/25

**3167ISOL**

Butelie de egalizare cu flanse si izolatie

CARACTERISTICI TEHNICE

- Material corp: oțel Fe 360
- Material izolator: PPE
- Presiune maximă de lucru: 10 bar
- Temperatura maxima de lucru: 100°C

Cod	Dimensiune	Debit max	Pret €	Ambalare
316 0106	DN50	9 (m³/h)		1/1
316 0107	DN65	20 (m³/h)		1/1
316 0108	DN80	25 (m³/h)		1/1
316 0109	DN100	40 (m³/h)		1/1
316 0110	DN125	65 (m³/h)		1/1
316 0111	DN150	95 (m³/h)		1/1

Prevazut cu baza suport pentru podea

**5539X**

Compensator hidraulic (butelie de egalizare)/colector din oțel cu izolatie si seturi de prindere, interaxa 125 mm, racorduri cu garnitura plata si semiolandez 1"1/2

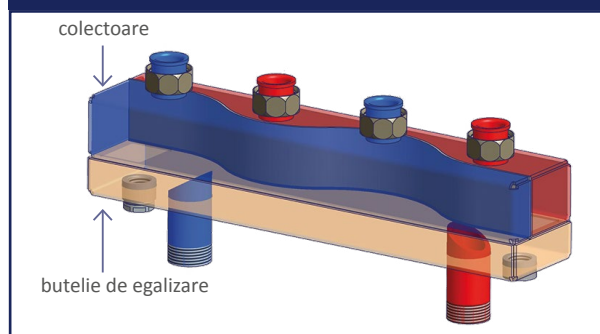

Cod	Dimens.	Nr. circuite	Debit max	Pret €	Ambalare
557 0001	80 x 80	2	3,0 (m³/h)		1/1
557 0002	80 x 80	3	3,0 (m³/h)		1/1
557 0003	120 x 120	2	7,0 (m³/h)		1/1
557 0004	120 x 120	3	7,0 (m³/h)		1/1
557 0005	120 x 120	4	7,0 (m³/h)		1/1

5539X**FUNCTIONARE****5538X
5540X**

Colector din oțel cu izolatie si seturi de prindere, interaxa 125 mm, racorduri cu garnitura plata si semiolandez 1"1/2



Cod	Dimens.	Nr. circuite	Debit max	Pret €	Ambalare
557 0006	80 x 60	2	3,0 (m³/h)		1/1
557 0007	80 x 60	3	3,0 (m³/h)		1/1
557 0008	120 x 80	3	6,5 (m³/h)		1/1
557 0009	120 x 80	4	6,5 (m³/h)		1/1
557 0010	120 x 80	5	6,5 (m³/h)		1/1
557 0366	120 x 80	6	6,5 (m³/h)		1/1

**5540X**

Set suportii pentru pardoseala izolati fonic si zincati

i Accesorii pentru colector de 120x80

Cod	Dimensiune	Pret €	Ambalare
557 0011	h= 405-600 mm		1/1

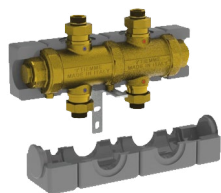
**7166**

Separator hidraulic cu filet si izolatie

Cod	Dimens.	Debit max	Pret €	Ambalare
316 0050	1"	2,5 (m³/h)		1/1

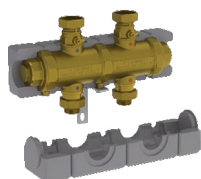
**7167**

Separator hidraulic cu filet, izolatie si supape

Cod	Dimens.	Debit max	Pret €	Ambalare
316 0065	1"	2,5 (m³/h)		1/1

7166 - 7167

EXEMPLE DE INSTALARE

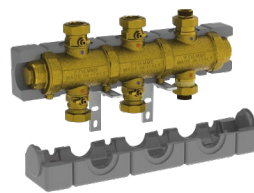
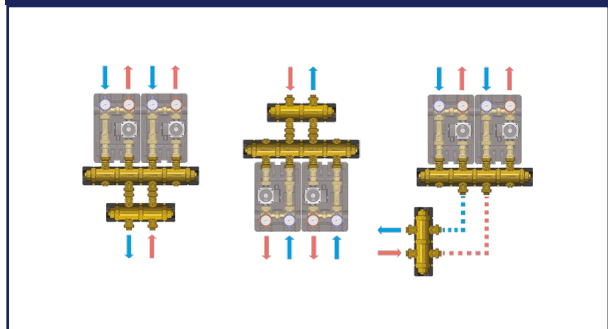
**5538G2M3**

Colector modular din alama pentru centrala termica cu robineti cu sfera, izolatie si cleme de fixare. Interaxa 125 mm, racorduri cu fata plana si piulita de 1"1/2

Cod	Dimens.	Nr. circuite	Debit max	Pret €	Ambalare
557 0368	2"1/2	2	2,2 (m³/h)		1/1
557 0483	2" 1/2	2	2,2 (m³/h)		1/1

5538G2M3

EXEMPLE DE INSTALARE

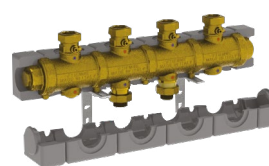
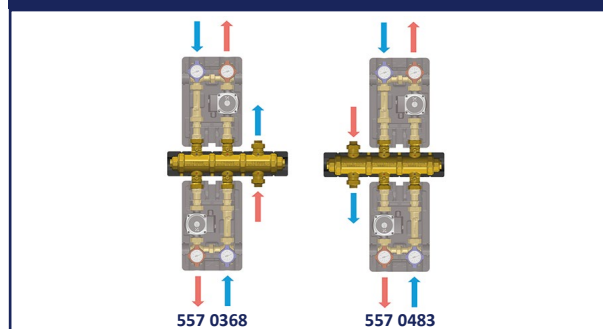
**5538G2M4**

Colector modular din alama pentru centrala termica cu robineti cu sfera, izolatie si cleme de fixare. Interaxa 125 mm, racorduri cu fata plana si piulita de 1"1/2

Cod	Dimens.	Nr. circuite	Debit max	Pret €	Ambalare
557 0369	2"1/2	2	2,2 (m³/h)		1/1
557 0484	2" 1/2	2	2,2 (m³/h)		1/1
557 0485	2" 1/2	2	2,2 (m³/h)		1/1

5538G2M4

EXEMPLE DE INSTALARE

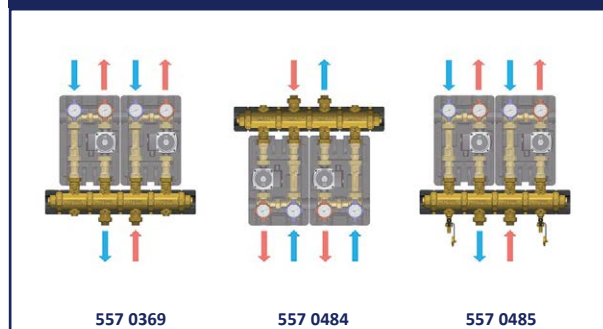

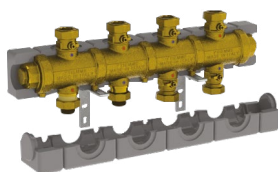
**5538G3M4**

Colector modular din alama pentru centrala termica cu robineti cu sfera, izolatie si cleme de fixare. Interaxa 125 mm, racorduri cu fata plana si piulita de 1"1/2

Cod	Dimens.	Nr. circuite	Debit max	Pret €	Ambalare
557 0370	2"1/2	3	2,2 (m ³ /h)		1/1
557 0486	2" 1/2	3	2,2 (m ³ /h)		1/1

5538G3M4

EXEMPLE DE INSTALARE

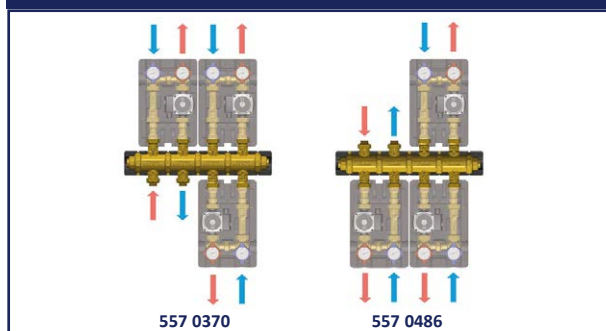

557 0370

557 0486

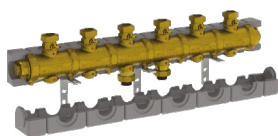
**5538G3M6**

Colector modular din alama pentru centrala termica cu robineti cu sfera, izolatie si cleme de fixare. Interaxa 125 mm, racorduri cu fata plana si piulita de 1"1/2

Cod	Dimens.	Nr. circuite	Debit max	Pret €	Ambalare
557 0371	2"1/2	3	2,2 (m ³ /h)		1/1
557 0487	2" 1/2	3	2,2 (m ³ /h)		1/1
557 0488	2" 1/2	3	2,2 (m ³ /h)		1/1

5538G3M6

EXEMPLE DE INSTALARE

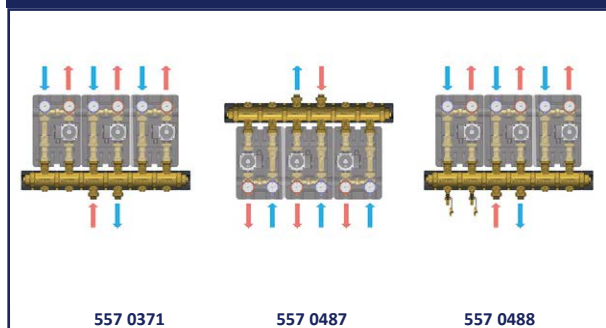

557 0371

557 0487

557 0488

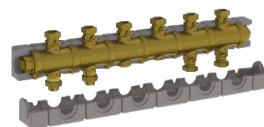
**5538G4M6**

Colector modular din alama pentru centrala termica cu robineti cu sfera, izolatie si cleme de fixare. Interaxa 125 mm, racorduri cu fata plana si piulita de 1"1/2

Cod	Dimens.	Nr. circuite	Debit max	Pret €	Ambalare
557 0477	2"1/2	4	2,2 (m ³ /h)		1/1
557 0478	2" 1/2	4	2,2 (m ³ /h)		1/1
557 0479	2" 1/2	4	2,2 (m ³ /h)		1/1

5538G4M6

EXEMPLE DE INSTALARE

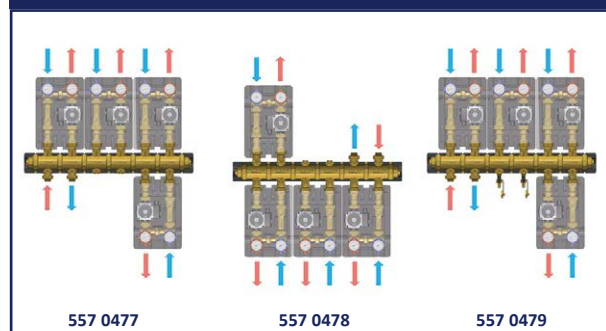

557 0477

557 0478

557 0479

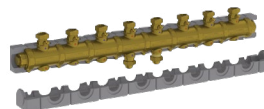
**5538G4M8**

Colector modular din alama pentru centrala termica cu robineti cu sfera, izolatie si cleme de fixare. Interaxa 125 mm, racorduri cu fata plana si piulita de 1"1/2

Cod	Dimens.	Nr. circuite	Debit max	Pret €	Ambalare
557 0480	2"1/2	4	2,2 (m ³ /h)		1/1
557 0481	2" 1/2	4	2,2 (m ³ /h)		1/1
557 0482	2" 1/2	4	2,2 (m ³ /h)		1/1

5538G4M8

EXEMPLE DE INSTALARE

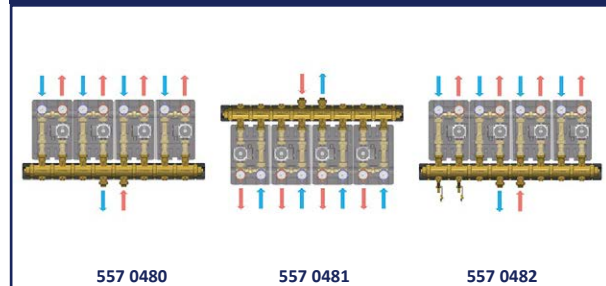

557 0480

557 0481

557 0482

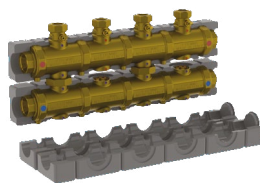
**5540G2M4**

Colector modular din alama pentru centrala termica cu robineti cu sfera, izolatie si cleme de fixare. Interaxa 125 mm, racorduri cu fata plana si piulita de 1"1/2

Cod	Dimens.	Nr. circuite	Debit max	Pret €	Ambalare
557 0372	2"1/2	2	6,5 (m³/h)		1/1
557 0489	2"1/2	2	6,5 (m³/h)		1/1
557 0490	2"1/2	2	6,5 (m³/h)		1/1

5540G2M4

EXEMPLE DE INSTALARE

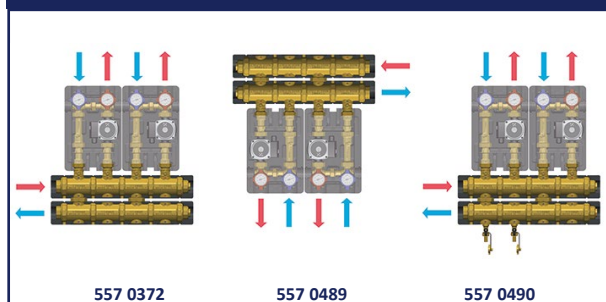

557 0372

557 0489

557 0490

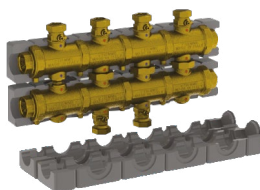
**5540G3M4**

Colector modular din alama pentru centrala termica cu robineti cu sfera, izolatie si cleme de fixare. Interaxa 125 mm, racorduri cu fata plana si piulita de 1"1/2

Cod	Dimens.	Nr. circuite	Debit max	Pret €	Ambalare
557 0373	2"1/2	3	6,5 (m³/h)		1/1
557 0491	2"1/2	3	6,5 (m³/h)		1/1
557 0492	2"1/2	3	6,5 (m³/h)		1/1

5540G3M4

EXEMPLE DE INSTALARE

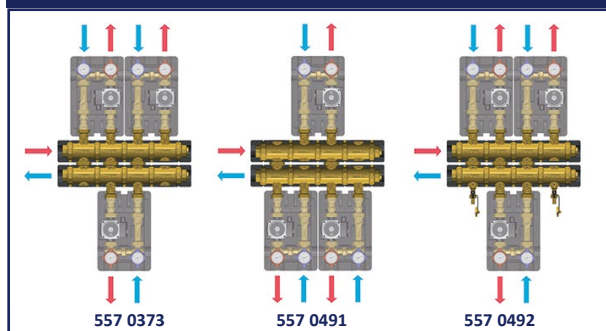

557 0373

557 0491

557 0492

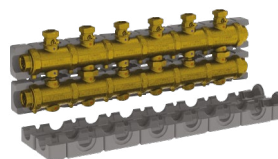
**5540G3M6**

Colector modular din alama pentru centrala termica cu robineti cu sfera, izolatie si cleme de fixare. Interaxa 125 mm, racorduri cu fata plana si piulita de 1"1/2

Cod	Dimens.	Nr. circuite	Debit max	Pret €	Ambalare
557 0374	2"1/2	3	6,5 (m³/h)		1/1
557 0493	2"1/2	3	6,5 (m³/h)		1/1
557 0494	2"1/2	3	6,5 (m³/h)		1/1

5540G3M6

EXEMPLE DE INSTALARE

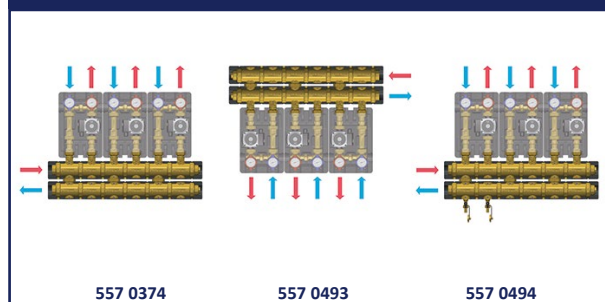

557 0374

557 0493

557 0494

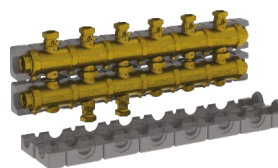
**5540G4M6**

Colector modular din alama pentru centrala termica cu robineti cu sfera, izolatie si cleme de fixare. Interaxa 125 mm, racorduri cu fata plana si piulita de 1"1/2

Cod	Dimens.	Nr. circuite	Debit max	Pret €	Ambalare
557 0375	2"1/2	4	6,5 (m³/h)		1/1
557 0495	2"1/2	4	6,5 (m³/h)		1/1
557 0496	2"1/2	4	6,5 (m³/h)		1/1

5540G4M6

EXEMPLE DE INSTALARE

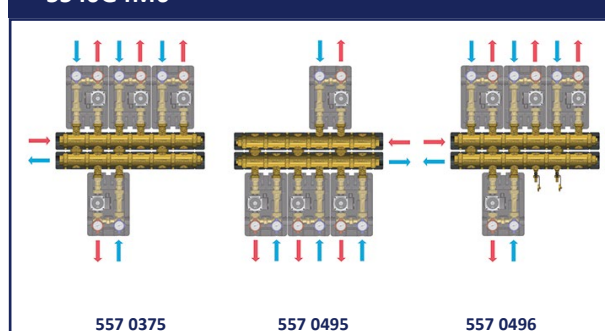

557 0375

557 0495

557 0496

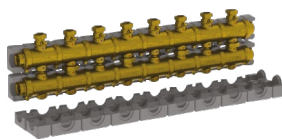
**5540G4M8**

Colector modular din alama pentru centrala termica cu robineti cu sfera, izolatie si cleme de fixare. Interaxa 125 mm, racorduri cu fata plana si piulita de 1"1/2

Cod	Dimens.	Nr. circuite	Debit max	Pret €	Ambalare
557 0376	2"1/2	4	6,5 (m³/h)		1/1
557 0497	2"1/2	4	6,5 (m³/h)		1/1
557 0498	2"1/2	4	6,5 (m³/h)		1/1

5540G4M8

EXEMPLE DE INSTALARE

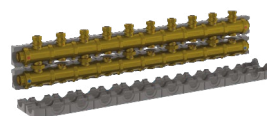
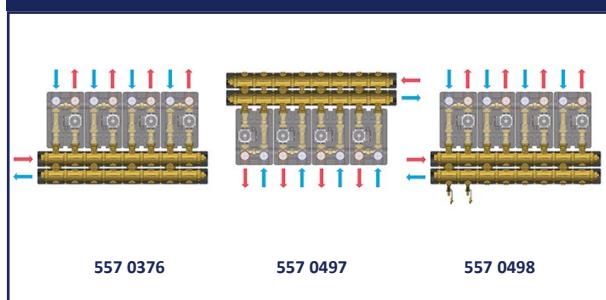
**5540G5M10**

Colector modular din alama pentru centrala termica cu robineti cu sfera, izolatie si cleme de fixare. Interaxa 125 mm, racorduri cu fata plana si piulita de 1"1/2

Cod	Dimens.	Nr. circuite	Debit max	Pret €	Ambalare
557 0476	2"1/2	5	6,5 (m³/h)		1/1
557 0501	2"1/2	5	6,5 (m³/h)		1/1
557 0502	2"1/2	5	6,5 (m³/h)		1/1

5540G5M10

EXEMPLE DE INSTALARE

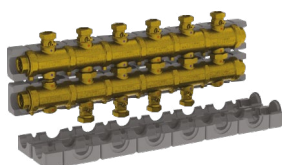
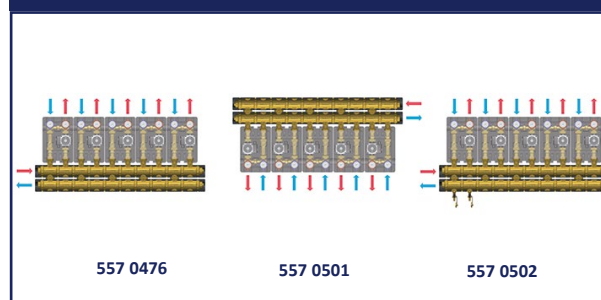
**5540G5M6**

Colector modular din alama pentru centrala termica cu robineti cu sfera, izolatie si cleme de fixare. Interaxa 125 mm, racorduri cu fata plana si piulita de 1"1/2

Cod	Dimens.	Nr. circuite	Debit max	Pret €	Ambalare
557 0377	2"1/2	5	6,5 (m³/h)		1/1
557 0499	2"1/2	5	6,5 (m³/h)		1/1
557 0500	2"1/2	5	6,5 (m³/h)		1/1

5540G5M6

EXEMPLE DE INSTALARE

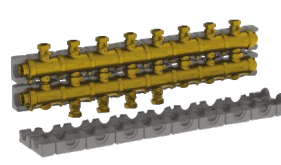
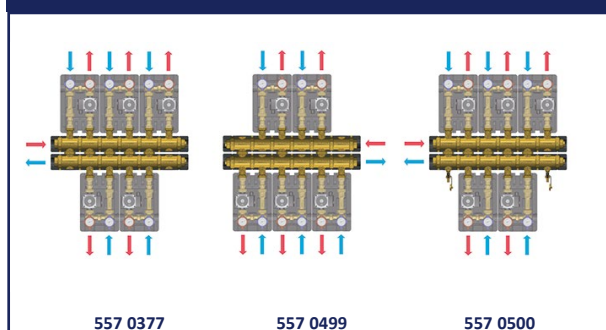
**5540G6M8**

Colector modular din alama pentru centrala termica cu robineti cu sfera, izolatie si cleme de fixare. Interaxa 125 mm, racorduri cu fata plana si piulita de 1"1/2

Cod	Dimens.	Nr. circuite	Debit max	Pret €	Ambalare
557 0378	2"1/2	6	6,5 (m³/h)		1/1
557 0503	2"1/2	6	6,5 (m³/h)		1/1
557 0504	2"1/2	6	6,5 (m³/h)		1/1

5540G6M8

EXEMPLE DE INSTALARE

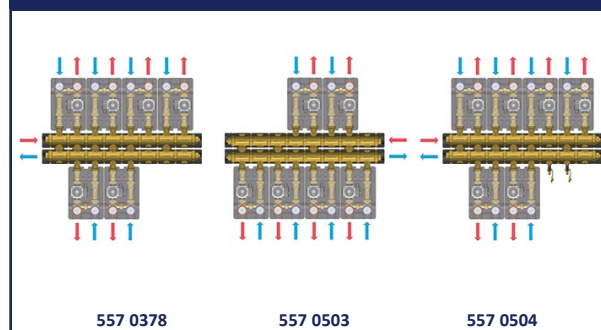

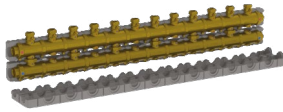
**5540G6M12**

Colector modular din alama pentru centrala termica cu robineti cu sfera, izolatie si cleme de fixare. Interaxa 125 mm, racorduri cu fata plana si piulita de 1"1/2

Cod	Dimens.	Nr. circuite	Debit max	Pret €	Ambalare
557 0505	2"1/2	6	6,5 (m³/h)		1/1
557 0506	2"1/2	6	6,5 (m³/h)		1/1
557 0507	2"1/2	6	6,5 (m³/h)		1/1

5540G6M12

EXEMPLE DE INSTALARE

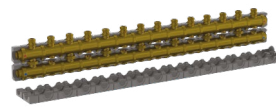
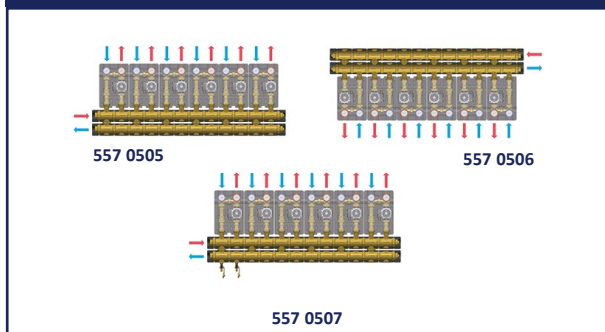
**5540G7M14**

Colector modular din alama pentru centrala termica cu robineti cu sfera, izolatie si cleme de fixare. Interaxa 125 mm, racorduri cu fata plana si piulita de 1"1/2

Cod	Dimens.	Nr. circuite	Debit max	Pret €	Ambalare
557 0472	2"1/2	7	6,5 (m³/h)		1/1
557 0511	2"1/2	7	6,5 (m³/h)		1/1
557 0512	2"1/2	7	6,5 (m³/h)		1/1

5540G7M14

EXEMPLE DE INSTALARE

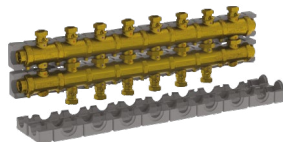
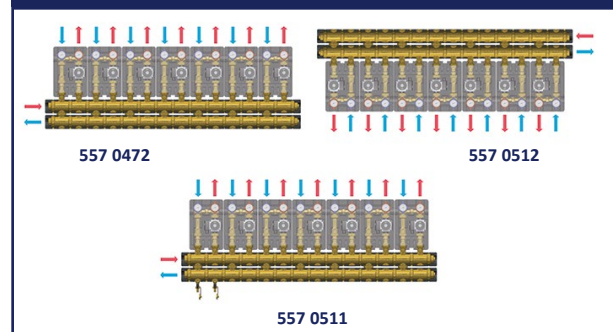
**5540G7M8**

Colector modular din alama pentru centrala termica cu robineti cu sfera, izolatie si cleme de fixare. Interaxa 125 mm, racorduri cu fata plana si piulita de 1"1/2

Cod	Dimens.	Nr. circuite	Debit max	Pret €	Ambalare
557 0508	2"1/2	7	6,5 (m³/h)		1/1
557 0509	2"1/2	7	6,5 (m³/h)		1/1
557 0510	2"1/2	7	6,5 (m³/h)		1/1

5540G7M8

EXEMPLE DE INSTALARE

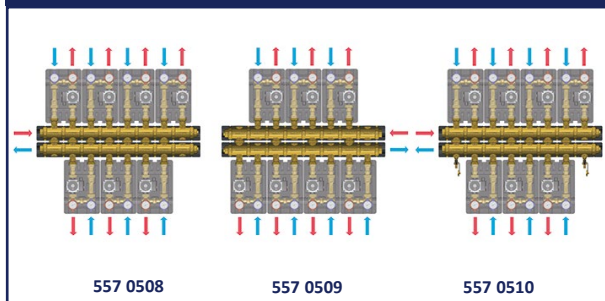
**IMPORTANT**

Se pot crea configuratii speciale, in functie de cerintele clientului



5538G

FUNCTIONARE

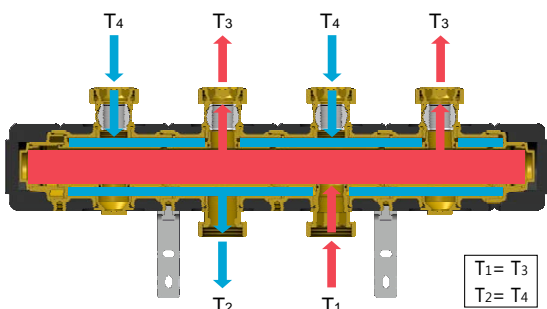

5540G

FUNCTIONARE

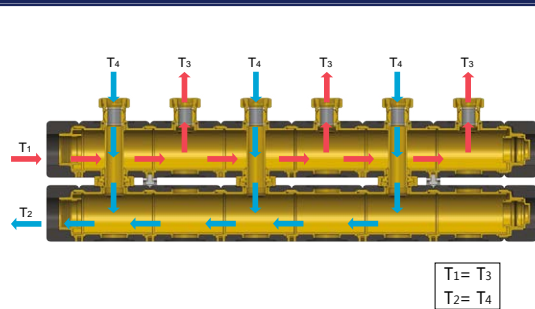

5538G - 5540G

INSTALARE

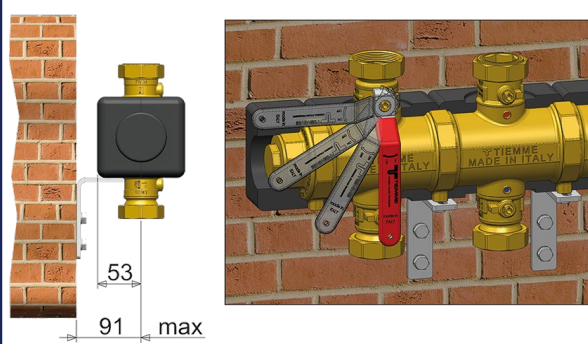

Instalarea pe perete este rapidă și ușoară datorită suportului special reglabil care poate fi fixat pe perete și pe colector cu ajutorul șuruburilor.

Scaunele pentru șuruburi au fost realizate direct pe colector. Cu robinetul cu bilă instalat direct pe colector, este posibil să se efectueze intervenții de întreținere întrerupând numai linia în cauză fără a opri restul instalației care va rămâne în funcțiune.

5538G - 5540G

GHID DE CONECTARE

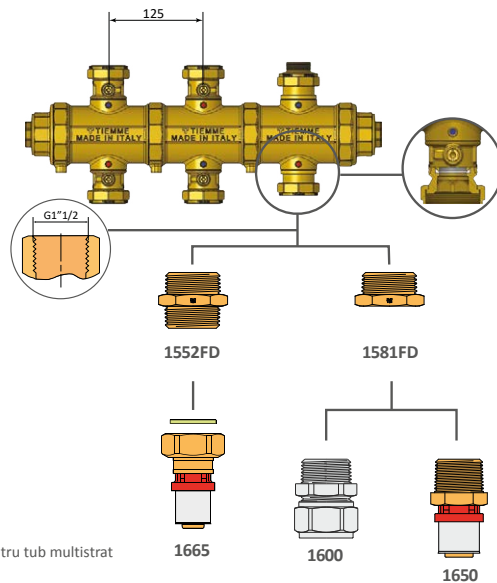
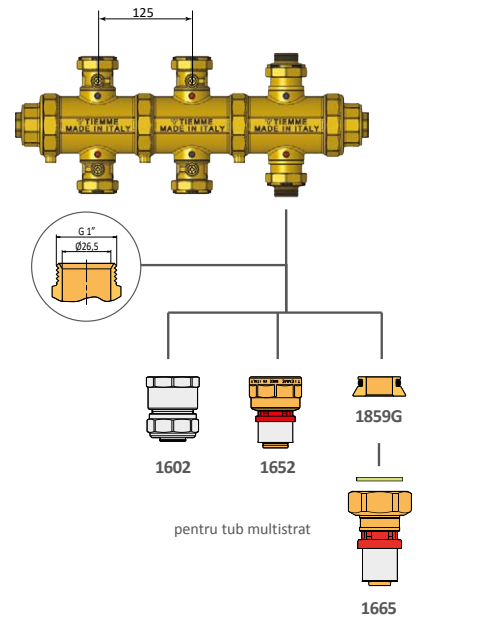

5540G

GHID DE CONECTARE

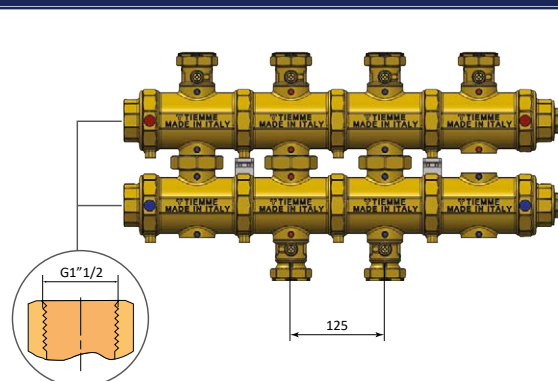

**1602**

Racord drept F
Pentru tub din polietilena reticulata cu insertie de aluminiu

Cod	Dimensiune	Pret €	Ambalare
160 0112	25 x 2,5 - 1"		5/50
160 0029	26 x 3,0 - 1"		5/100
160 0039	32 x 3,0 - 1"		5/50

**1652**

Racord drept F
Pentru tub din polietilena reticulata cu insertie de aluminiu

Cod	Dimensiune	Pret €	Ambalare
165 0268	25 x 2,5 - 1"		5/25
165 0053	26 x 3,0 - 1"		5/25
165 0050	32 x 3,0 - 1"		5/25

**1665**

Racord drept cu piulita si garnitura plata
Pentru tub din polietilena reticulata cu insertie de aluminiu

Cod	Dimensiune	Pret €	Ambalare
165 0233	25 x 2,5 - 1"		2/50
165 0071	26 x 3,0 - 1"		2/50
165 0134	32 x 3,0 - 1"		2/100
165 0239	40 x 3,5 - 1"1/2		1/25

Se utilizeaza cu 1859

Se utilizeaza cu 1552FD

**1859**

Adaptor pentru a transforma un filet conexiuni 1" G in filet cu fata planat

Cod	Dimensiune	Pret €	Ambalare
144 0234	1"G		10/300

**1552FD**

Niplu fata dreapta si garnitura plata

Cod	Dimensiune	Pret €	Ambalare
471 0086	1"1/2 x 1"1/2		2/30

**1881**

Reductie M/F cu garnitura O-ring pentru colectoare

Cod	Dimensiune	Pret €	Ambalare
195 0066	1" 1/2 x 3/4"		5/70

**1828Z**

Consola cu suruburi pentru colectoare pentru centrala termica

Cod	Dimensiune	Pret €	Ambalare
179 0323	unica		1/25

**2095R**

Maneta plata rosie din otel plastifiat

Cod	Dimensiune	Pret €	Ambalare
209 0069	unica		1/10

**2121CP**

Robinet M/F ISO 228 cu maneta de culoare rosie si albastra pentru colectoare si GARNITURA PLATA

Cod	Dimensiune	Pret €	Ambalare
 maneta tip levier rosie			
212 0122	1"1/2		3/12

Cod	Dimensiune	Pret €	Ambalare
 maneta tip levier neagra			
212 0124	1"1/2		3/12



5535G
Grup de pompare



CARACTERISTICI TEHNICE:

- Material corp: Alama CW 617 N
- Garnituri: EPDM
- Material izolat: EPP
- Dimensiune: DN 25 (1")
- Conexiuni:
 - Intrare: 1"1/2 etansare mecanica plana
 - Iesire: 1"1/2 etansare mecanica plana
- Presiunea maxima: 8 bar
- Temp. maxima de intrare: 110°C
- Pompe:
 - Grundfos UPM3 HYBRID 25/70
 - Grundfos UPS 25-65
 - Wilo PARA 25/7
 - Wilo PARA 25/9

Cod	Dimensiune	Pret €	Ambalare
316 0017	Fara pompa		1/1
316 0043	Wilo PARA 25/7		1/1
316 0042	UPM3 HYBRID 25/70		1/1
316 0090	Wilo PARA 25/9		1/1
316 0018	Grundfos UPS 25-65		1/1

ErP READY

Disponibila pentru tari non UE



5535GPF
Grup de amestec cu punct fix



CARACTERISTICI TEHNICE:

- Material corp: Alama CW 617 N
- Garnituri: EPDM
- Material izolat: EPP
- Dimensiune: DN 25 (1")
- Conexiuni:
 - Intrare: 1"1/2 etansare mecanica plana
 - Iesire: 1"1/2 etansare mecanica plana
- Presiunea maxima: 8 bar
- Temp. maxima de intrare: 110°C
- Domeniul de reglare: 20÷50°C
- Termostat de siguranta: 55°C
- Pompe:
 - Grundfos UPM3 HYBRID 25/70
 - Grundfos UPS 25-65
 - Wilo PARA 25/7
 - Wilo PARA 25/9

Cod	Dimensiune	Pret €	Ambalare
316 0020	Fara pompa		1/1
316 0046	Wilo PARA 25/7		1/1
316 0045	Grundfos UPM3 HYBRID 25/70		1/1
316 0091	Wilo PARA 25/9		1/1
316 0021	Grundfos UPS 25-65		1/1

ErP READY

Disponibila pentru tari non UE

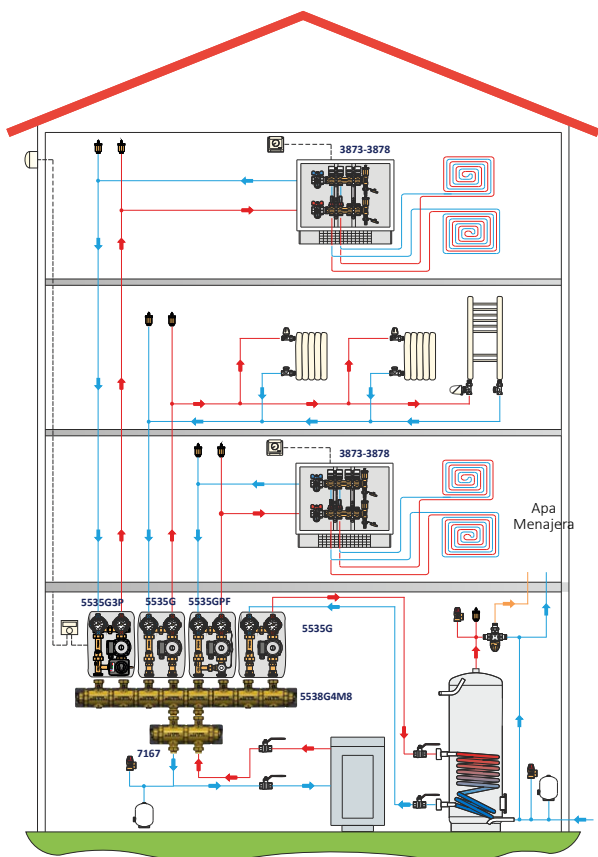

TUTORIAL VIDEO



Grupuri de pompare



5535G3P
Grup de amestec modulant



CARACTERISTICI TEHNICE:

- Material corp: Alama CW 617 N
- Garnituri: EPDM
- Material izolatie: EPP
- Dimensiune: DN 25 (1")
- Conexiuni:
 - Intrare: 1"1/2 etansare mecanica plana
 - Iesire: 1"1/2 etansare mecanica plana
- Presiunea maxima: 8 bar
- Temp. maxima de intrare: 110°C
- Pompe:
 - Grundfos UPM3 HYBRID 25/70
 - Grundfos UPS 25-65
 - Wilo PARA 25/7
 - Wilo PARA 25/9

SERVOMOTOR

- Alimentare: 230Vac comanda SPDT (3 puncte)
- Durata rotatiei: 120 secunde (unghi de 90°)
- Cuplu nominal: 7 Nm

Cod	Dimensiune	Pret €	Ambalare
316 0023	Fara pompa		1/1
316 0049	Wilo PARA 25/7		1/1
316 0048	Grundfos UPM3 HYBRID 25/70		1/1
316 0092	Wilo PARA 25/9		1/1

ErP READY



5536G
Grup de pompare cu izolatie pentru racire



CARACTERISTICI TEHNICE:

- Material corp: Alama CW 617 N
 - Garnituri: EPDM
 - Material izolatie: PE-X expandat cu celule inchise
 - Dimensiune: DN 25 (1")
 - Intrare: 1"1/2 etansare mecanica plana
 - Iesire: 1"1/2 etansare mecanica plana
 - 8 bar
 - 110°C
 - Wilo PARA 25/7
 - Wilo PARA 25/9
- Presiunea maxima:
Temp. maxima de intrare:
Pompe:

Cod	Dimensiune	Pret €	Ambalare
557 0383	Fara pompa		1/1
557 0386	Wilo PARA 25/7		1/1
557 0559	Wilo PARA 25/9		1/1

ErP READY





5536GS
Grup de amestec modulant și
izolație pentru răcire



CARACTERISTICI TEHNICE:

- Material corp: Alama CW 617 N
- Garnituri: EPDM
- Material izolație: PE-X expandat cu celule închise
- Dimensiune: DN 25 (1")
- Conexiuni:
 - Intrare: 1"1/2 etansare mecanica plana
 - Iesire: 1"1/2 etansare mecanica plana
- Presiunea maxima: 8 bar
- Temp. maxima de intrare: 110°C
- Pompe:
 - Wilo PARA 25/7
 - Wilo PARA 25/9

SERVOMOTOR

- Alimentare: 24Vac comanda 0-10Vdc
- Durata rotatiei: 120 secunde (unghi de 90°)
- Cuplu nominal: 7 Nm

Cod	Dimensiune	Pret €	Ambalare
557 0388	Fara pompa		1/1
557 0391	Wilo PARA 25/7		1/1
557 0560	Wilo PARA 25/9		1/1

ErP READY



5542GS
Grup hidraulic cu mixer și
servomotor complet cu
regulator electronic în punct
fix, dotat cu racorduri plate de
oprire 1"1/2 M cu izolație pentru
răcire



CARACTERISTICI TEHNICE:

- Material corp: Alama CW 617 N
- Garnituri: EPDM
- Material izolație: PE-X expandat cu celule închise
- Dimensiune: DN25 (1")
- Conexiuni 125 mm:
 - Intrare: 1"1/2 etansare mecanica plana
 - Iesire: 1"1/2 etansare mecanica plana
- Presiunea maxima: 8 bar
- Temp. maxima de intrare: 110°C

SERVOMOTOR

- Alimentare: 230 Vac
- Durata rotatiei: 120 sec (unghi de 90°)
- Cuplu nominal: 6 Nm

Cod	Dimensiune	Pret €	Ambalare
557 0717	Wilo PARA 25/7		1/1
557 0723	Wilo PARA 25/9		1/1

ErP READY

Noutati

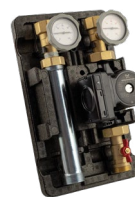

5534G
Grup de pompare



CARACTERISTICI TEHNICE:

- Material corp: alama CW 617 N
- Material garnituri: EPDM
- Material carcasă izolatoare: EPP
- Dimensiune: DN32 (1"1 / 4)
- Distanța interax 125 mm:
 - Intrare: 1"1/2 fata plana
 - Iesire: 1"1/4 feminin
- Pmax de utilizare: 8 bar
- Tmax de utilizare: 110 ° C

Cod	Dimensiune	Pret €	Ambalare
316 0093	Fara pompa		1/1
316 0095	Grundfos UPML 32-105 AUTO		1/1

ErP READY



5534G3P
Grup de amestec pentru
servomotor (nu este inclus)



CARACTERISTICI TEHNICE:

- Material caroserie: alama CW 617 N
- Material garnituri: EPDM
- Material carcasă izolatoare: EPP
- Dimensiune: DN 32
- Distanța interax 125 mm:
 - Intrare: 1"1/2 fata plana
 - Iesire: 1"1/4 feminin
- Pmax de utilizare: 8 bar
- Tmax de utilizare: 110 ° C

i Pentru a fi utilizat cu servomotorul 9562SERV

Cod	Dimensiune	Pret €	Ambalare
316 0097	Fara pompa		1/1
316 0099	Grundfos UPML 32-105 AUTO		1/1

ErP READY

**5535DIFF**

By-pass diferential cu camp de reglare 50-400 mbar. Racord masculin 25x1,5 (utilizabil cu toate grupurile hidraulice)

Cod	Dimensiune	Pret €	Ambalare
316 0029	50-400 mbar		1/50

**2075KIT03**

Termostat de siguranta tip pastila cu cablu si conector drept

Cod	Dimensiune	Pret €	Ambalare
557 0024	55 °C		1/50

**3880GPF**

Vana de amestec pentru reglare cu punct fix

i Se cupleaza la kitul termostatic 9561KIT02

Cod	Dimensiune	Pret €	Ambalare
316 0030	-		1/4

**9561KIT02**

Kit niplu + tub + cap termostatic 20-50°C cu sonda la distant Ø 9 mm. Racord masculin M30x1,5

i Se utilizeaza cu grupul de amestec cu punct fix 5535GPF

Cod	Dimensiune	Pret €	Ambalare
450 0150	20-50 °C		1/10

**3880GSM**

Vana de amestec zona pentru comanda servomotor (nu este furnizat)

i Pentru a fi utilizat cu servomotorul 9562SERV

Cod	Dimensiune	Pret €	Ambalare
316 0031	-		1/4

**9562SERV**

Servomotor complet cu kit pentru conectarea vanei de amestec art. 3880GSM

CARACTERISTICI TEHNICE:

- Material corp: Nylon FV ignifug
- Timp de rotatie: 120 sec
- Unghi de rotatie: 90°
- Cuplu nominal: 7 Nm
- Grad de protectie: IP 40
- Alimentare:
 - 230 Vac SPDT (3 puncte)
 - 24 Vac SPDT (3 puncte)
 - 24 Vac (0-10 Vdc)

Cod	Dimensiune	Pret €	Ambalare
557 0023	230 Vac comanda SPDT (3 puncte)		1/8
557 0306	24 Vac comanda SPDT (3 puncte)		1/8
557 0307	24 Vac comanda 0-10 Vdc		1/8

**9569SERV**

Servomotor complet cu regulator electronic în punct fix

CARACTERISTICI TEHNICE:

- Material corp: PC
- Timp de rotatie: 120 sec.
- Unghi de rotatie: 90°
- Cuplu nominal: 6 Nm
- Grad de protectie: IP 42
- Alimentare:
 - 230 Vac (3 puncte)

Cod	Dimensiune	Pret €	Ambalare
557 0714	230 Vac (3 puncte)		1/4



**4745MANOP**

Maner cu termometru de imersie pentru grupuri hidraulice

Cod	Dimensiune	Pret €	Ambalare
470 0183	Albastru		10/40
470 0184	Rosie		10/40

**5537KIT**

Kit niplu + tub pentru sonda Ø 6 mm. Racord masculin 25x1,5

i Se utilizeaza cu grupul de amestec cu servomotor 5535G3P

Cod	Dimensiune	Pret €	Ambalare
557 0022	-		1/25

**1665**

Racord drept cu piulita si garnitura plata
Pentru tub din polietilena reticulata cu insertie de aluminiu

Cod	Dimensiune	Pret €	Ambalare
165 0240	32 x 1"1/2		1/50
165 0239	40 x 1"1/2		1/25

**1557SET**

Set olandez din alama pentru pompa cu racord F/F si garnitura plata

i Setul include: 2 stuturi, 2 piulițe, 2 garnituri

Cod	Dimensiune	Atac pompa	Pret €	Ambalare
150 0355	1"	1"1/2		1/20

**3890PW2**

Pompa de circulatie de inalta eficienta Wilo PARA 25/7 cu interaxa 130 mm. Iesire 1"1/2 corp de fonta.

+ POMPE DE INALTA EFICIENTA

Cod	Dimensiune	Pret €	Ambalare
450 0358	Wilo PARA 25/7		1/1

**3890PW5**

Pompa de circulatie de inalta eficienta Wilo PARA 25/9 cu interaxa 130 mm. Iesire 1"1/2 corp de fonta.

+ POMPE DE INALTA EFICIENTA

Cod	Dimensiune	Pret €	Ambalare
450 0557	Wilo PARA 25/9		1/1

**3890PV**

Pompa de circulatie cu flux variabil clasa A. Iesire de 1"1/2 interaxa 130 mm

+ POMPE DE INALTA EFICIENTA

Cod	Dimensiune	Pret €	Ambalare
450 0091	Grundfos UPM3 HYBRID 25/70		1/1

**3890P**

Pompa de circulatie cu trei viteze. Iesire de 1"1/2 interaxa 130 mm.

Cod	Dimensiune	Pret €	Ambalare
450 0033	Grundfos UPS 25-55		1/1

Disponibila pentru tari non UE

**3890PU**

Pompă de circulație de înaltă eficiență. Conexiuni de 2", distanță interax 180 mm

+ POMPE DE INALTA EFICIENTA

Cod	Dimensiune	Pret €	Ambalare
450 0637	Grundfos UPML 32-105		1/1

**3150**

TM-MAG MINI Filtru impuritati magnetice compact pentru centrala murala

**CARACTERISTICI TEHNICE:**

- Gradul de filtrare: 800 µm
- Material corp: alamă CW617N / PA6.6 30% F.V.
- Temperatura maxima de lucru: 90°C

Cod	Dimensiune	Pret €	Ambalare
315 0039	3/4"		1/10

**3146KIT**

Kit TM-MAG pentru centrala murala

**CARACTERISTICI TEHNICE:**

- Grad de filtrare: 800 µm
- Materialul paharului colector: policarbonat
- Corp: din alama CW 617N nichelat
- Temperatura maxima de exercitiu: 95°C
- Livrat cu robinet de golire

i Setul include: 1 filtru TM-MAG 3/4", 1 robinet cu bilă F cu piuliță 3/4" cu fluture roșu, 1 robinet cu bilă F cu piuliță de 1/2" cu fluture roșu, 1 robinet cu bilă F cu 3/4" robinet cu fluture albastru și filtru Y de 1/2"

Cod	Dimensiune	Pret €	Ambalare
315 0016	3/4"		1/4

**3142**

TM-MAG Filtru magnetic sub centrala cu robinet cu sfera si pahar colector alama CW617N

**CARACTERISTICI TEHNICE:**

- Grad de filtrare: 800 µm
- Materialul paharului colector: din alama CW 617N nichelat
- Corp: din alama CW 617N nichelat
- Temperatura maxima de exercitiu: 95°C
- Livrat cu robinet de golire

Cod	Dimensiune	Pret €	Ambalare
315 0030	3/4"		1/8

**3154**

TM-MAG EVO Filtru magnetic de separare a murdariei situat sub centrala termica cu „by-pass” si surub.

**CARACTERISTICI TEHNICE:**

- Gradul de filtrare: 800 µm
- Material corp: alamă CW617N nichelat
- Temperatura maxima de lucru: 95°C

CU BY-PASS

Cod	Dimensiune	Pret €	Ambalare
315 0071	3/4"		1/10

TUTORIAL VIDEO

TM-MAG EVO Filtru magnetic cu separator impuritati

MORE INFO

**3154C**

Set (robinet + garnitura) pentru filtru magnetic situat sub centrala termica cu „bypass” si surub (Art. 3154)

Cod	Dimensiune	Pret €	Ambalare
313 0135	1/2"		1/50

La cerere

**3148**

Filtru magnetic linear cu separator de impuritati, cu pahar colector alama CW617N si set de prindere, racorduri exterioare tip olandez M/M

**CARACTERISTICI TEHNICE:**

- Materialul paharului colector: alama CW 617N
- Corp: din alama CW 617N
- Presiune maxima de exercitiu: 10 bar
- Temperatura maxima de exercitiu: 95°C
- Filete interioare: M/M ISO 228
- Livrat cu si robinet de golire

Cod	Dimensiune	Pret €	Ambalare
315 0005	1/2"		1/5
315 0006	3/4"		1/5
315 0007	1"		1/5
315 0008	1"1/4		1/5



LISTA DE PREȚURI

**3149**

Filtru magnetic linear cu separator de impuritati, cu pahar colector alama CW617N si set de prindere, cu iesiri M/F

**CARACTERISTICI TEHNICE:**

- Materialul paharului colector: alama CW 617N
- Corp: din alama CW 617
- Presiune maxima de exercitiu: 10 bar
- Temperatura maxima de exercitiu: 95°C
- Filete interioare: F/M ISO 228
- Livrat cu si robinet de golire

Cod	Dimensiune F M	Pret €	Ambalare
315 0009	1/2" x 3/4"		1/5
315 0010	3/4" x 1"		1/5
315 0011	1" x 1"1/4		1/5
315 0012	1"1/4 x 1"1/2		1/5

**3141**

TM-MAG PLUS Filtru magnetic cu separator de impuritati

**CARACTERISTICE TEHNICE**

- Gradul de filtrare: 800 µm
- Material corp: PA66 + FV 30%
- Temperatura maxima de lucru: 95°C

ORIENTABIL

Cod	Dimensiune	Pret €	Ambalare
315 0032	3/4"		1/4
315 0038	1"		1/4

NOUȚĂȚI

**3149HF**

TM-MAG MAXI Filtru magnetic linear cu separator de impuritati, cu iesiri F - cu debit ridicat

**CARACTERISTICI TEHNICE:**

- Gradul de filtrare: 800 µm
- Material corp: alamă CW617N nichelat
- Temperatura maxima de lucru: 90°C

Cod	Dimensiune	Pret €	Ambalare
315 0084	1"1/4		1/2

**1525N**

Racord drept M nichelat cu piulita si garnitura plata

Cod	Dimensiune	Pret €	Ambalare
150 0891	1/2" x 1/2"		5/100

**1524**

Racord drept F-F cu olandez si garnitura plata

Cod	Dimensiune	Pret €	Ambalare
150 0858	3/4"		1/100

**3146X**

Cartuş de schimb pentru filtrul magnetic sub centrala

Cod	Dimensiune	Pret €	Ambalare
313 0090	-		1/50

**3148A**

Inel cu magneti

Cod	Dimensiune	Pret €	Ambalare
313 0105	-		1/14

**3146OR**

O-ring pentru filtru magnetic sub centrala

Cod	Dimensiune	Pret €	Ambalare
040 0118	-		10/1000

**3142T**

Pahar de alamă de schimb pentru filtrul magnetic sub centrala

Cod	Dimensiune	Pret €	Ambalare
313 0128	-		1/15

**3155**

ULISSE Dozator proportional cu cristale de polifosfati, cu supapa de blocare si cartus, livrat cu un cartus de schimb

Cod	Dimensiune	Pret €	Ambalare
310 0001	1/2"		1/6

**3155POL**

Cartus de schimb cu cristale de polifosfati pentru dozatorul proportional (2 seturi)

Cod	Dimensiune	Pret €	Ambalare
310 0003	pentru art. 3155		1/10

**1896**

Supapa automata de aerisire nichelata

Cod	Dimensiune	Pret €	Ambalare
198 0068	1/2"		1/20
198 0074	3/4"		1/20

Conexiune masculin cu etanșare O-ring

**1896GG**

Ansamblu Flotor pentru supapele de aerisire automate art 1896

Cod	Dimensiune	Pret €	Ambalare
198 0070	-		1/20

**1914**

Supapă de aerisire automată nichelată, racord lateral

Cod	Dimensiune	∅	Pret €	Ambalare
198 0126	3/8"	39		1/50
198 0127	1/2"	39		1/50

**1913**

Supapa automata de aerisire nichelata

Cod	Dimensiune	∅	Pret €	Ambalare
198 0128	3/8"	39		1/50
198 0129	1/2"	39		1/50



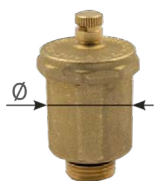

1913G
Supapa automata de aerisire

Cod	Dimensiune	Ø	Pret €	Ambalare
198 0130	3/8"	39		1/50
198 0131	1/2"	39		1/50



1898
Supapa automata de aerisire laterala

Cod	Dimensiune	Ø	Pret €	Ambalare
198 0005	3/8"	39		1/50
198 0004	1/2"	39		1/50



1898G34
Supapa automata de aerisire laterala cu corp de 34 mm

Cod	Dimensiune	Ø	Pret €	Ambalare
198 0114	3/8"	34		1/70
198 0092	1/2"	34		1/70



1898KIT34
Set Supapa automata de aerisire + Supapa de blocare

 Kit format din 1898G34 + 1901P

Cod	Dimensiune	Ø	Pret €	Ambalare
198 0112	3/8"	34		1/70
198 0113	1/2"	34		1/70



1899
Supapa automata de aerisire cu racord laterala

Cod	Dimensiune	Ø	Pret €	Ambalare
198 0011	3/8"	39		1/50
198 0003	1/2"	39		1/50

Până la terminarea stocului

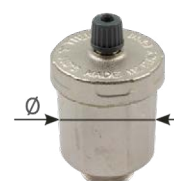

1900
Supapa automata de aerisire

Cod	Dimensiune	Ø	Pret €	Ambalare
198 0002	3/8"	39		1/50
198 0001	1/2"	39		1/50
198 0013	3/4"	45,5		1/25
198 0022	1"	45,5		1/25

Până la terminarea stocului

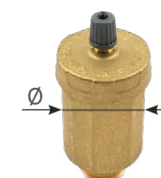

1900G
Supapa automata de aerisire

Cod	Dimensiune	Ø	Pret €	Ambalare
198 0014	3/8"	39		1/50
198 0007	1/2"	39		1/50

Până la terminarea stocului



1900N34
Supapa automata de aerisire

Cod	Dimensiune	Ø	Pret €	Ambalare
198 0024	3/8"	34		1/40
198 0029	1/2"	34		1/40



1900G34
Supapa automata de aerisire

Cod	Dimensiune	Ø	Pret €	Ambalare
198 0017	3/8"	34		1/40
198 0019	1/2"	34		1/40



3350
Supapa de aerisire pentru radiatoare

Cod	Dimensiune	Pret €	Ambalare
198 0021	1/8"		10/500
198 0020	1/4"		10/500
198 0015	3/8"		10/500
198 0016	1/2"		10/500



3351
Supapa de aerisire pentru radiatoare, cu garnitura de etansare

Cod	Dimensiune	Pret €	Ambalare
198 0010	1/4"		10/500
198 0008	3/8"		10/500
198 0006	1/2"		10/500



3352
Supapa de aerisire pentru radiatoare

Cod	Dimensiune	Pret €	Ambalare
198 0049	1/4"		10/500
198 0047	3/8"		10/500
198 0018	1/2"		10/500



1901
Supapa de blocare cu garnitura de etansare si obturator din alama

Cod	Dimensiune	Pret €	Ambalare
198 0012	3/8"		10/300
198 0009	1/2"		10/100
198 0023	M 1/2" - F 3/8"		10/300



1901P
Supapa de blocare cu garnitura de etansare si obturator din plastic

Cod	Dimensiune	Pret €	Ambalare
198 0106	3/8"		10/300
198 0108	1/2"		10/300
198 0110	M 1/2" - F 3/8"		10/300



1901PN
Supapa de blocare nichelata cu garnitura de etansare si obturator din plastic

Cod	Dimensiune	Pret €	Ambalare
198 0107	3/8"		10/300
198 0109	1/2"		10/300
198 0111	M 1/2" - F 3/8"		10/300

La cerere





5532PDC
Modul hidronic de coordonare
PDC-ACM

Cod	Dimensiune	Pret €	Ambalare
556 0272	1"		1/1

5532PDC GHID DE INSTALARE

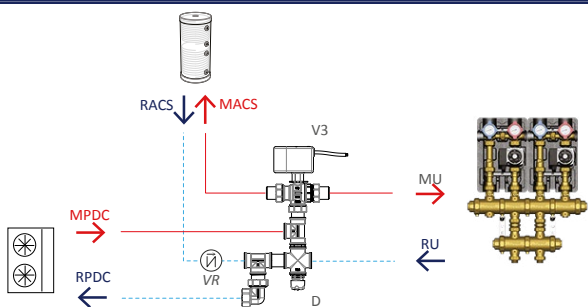

LEGENDĂ

- MU: tur alimentare
- RU: retur alimentare
- MACS: tur apă caldă menajeră
- RACS: retur apă caldă menajeră
- MPDC: tur pompă de căldură
- RPDC: retur pompă de căldură
- V3: supapă cu 3 căi motorizată
- VR: Supapă de reținere
- D: By-pass diferențial



5532HYBRID
Modul hidronic de coordonare
sursa dubla

Cod	Dimensiune	Pret €	Ambalare
556 0273	1"		1/1

5532HYBRID GHID DE INSTALARE

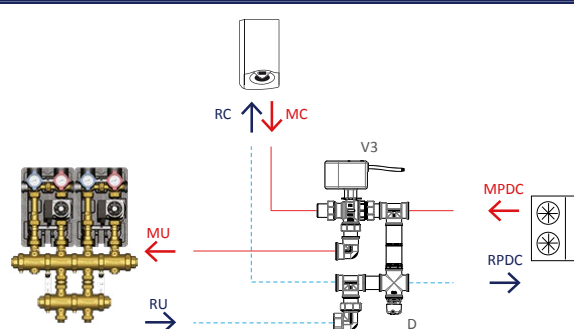

LEGENDĂ

- MC: tur centrală
- RC: retur centrală
- MU: tur alimentare
- RU: retur alimentare
- MPDC: tur pompă de căldură
- RPDC: retur pompă de căldură
- V3: supapă cu 3 căi motorizată
- D: By-pass diferențial



1926
Supapa anti-înghet pentru
pompa de caldura

Cod	Dimensiune	Pret €	Ambalare
192 0157	1"		1/10
192 0158	1"1/4		1/10



3890VD

Vana termostatică cu 3 cai deviație/amestec pentru gestiunea instalațiilor de încălzire și răcire.

În funcție de poziția de montaj funcționează ca vana deviatoare sau ca vana de amestec.

Cod	Dimensiune	Pret €	Ambalare
450 0047	1"		2/20
450 0515	1"1/4		1/10
450 0516	1"1/2		1/10

3890VD

GHID DE INSTALARE

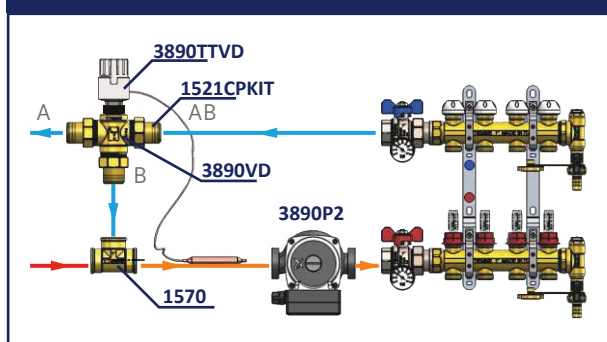

1521CPKIT

Kit olandez pentru Vana termostatică cu 3 cai deviație/amestec

i Setul include: 3 stuturi, 3 piulițe, 3 garnituri

Cod	Dimensiune	Pret €	Ambalare
150 1017	1" F x 3/4" M		1/20
150 1013	1"1/4 F x 1" M		1/15
150 1014	1"1/2 F x 1"1/4 M		1/10



1570

Teu F

Cod	Dimensiune	Pret €	Ambalare
150 0009	3/4" x 3/4" x 3/4"		5/50
150 0005	1" x 1" x 1"		5/25
150 0029	1"1/4 x 1"1/4 x 1"1/4		5/20



3890TTVD

Cap termostatic cu sonda la distanță pentru supapa de deviere

Cod	Dimensiune	Pret €	Ambalare
450 0527	20 - 50°C		1/10
450 0556	40 - 70°C		1/10



**4732**

Supapa de siguranta anti-condensare

i Alte calibrari disponibile la cerere

Cod	Dimensiune	Pret €	Ambalare
324 0031	1" 45°C		1/8
324 0017	1" 60°C		1/8
324 0033	1"1/4 45°C		1/4
324 0018	1"1/4 60°C		1/4
324 0035	1"1/2 50°C		1/4
324 0019	1"1/2 60°C		1/4

Noutati

**1521CPKIT**

Kit olandez

i Setul include: 3 stuturi, 3 piulițe pivotante, 3 garnituri

Cod	Dimensiune	Pret €	Ambalare
150 1017	1" F x 3/4" M		1/20
150 1013	1"1/4 F x 1" M		1/15
150 1014	1"1/2 F x 1"1/4 M		1/10

4737

GHID DE INSTALARE

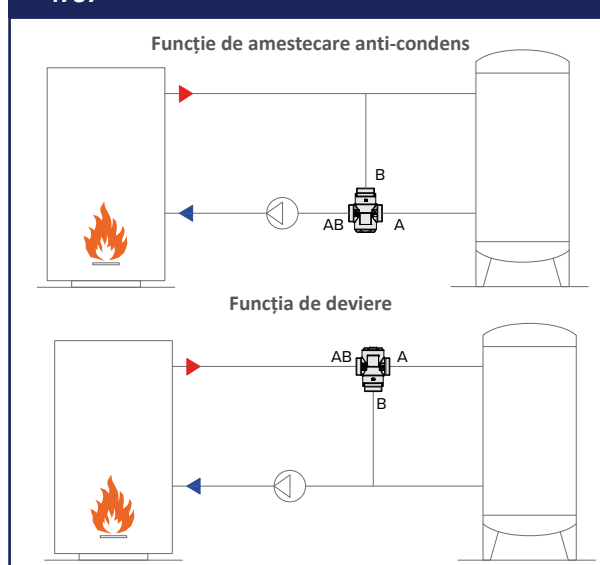
**6535G**

Robinet de echilibrare din alama pentru circuite hidraulice cu cititor de presiune

i Accesorii: 6535ISOL - 6535ET - 6536
Piese de schimb: 6535PP
Pentru coduri vezi pagina 357

Cod	Dimensiune	Pret €	Ambalare
651 0008	1/2"		1/5
651 0009	3/4"		1/5
651 0010	1"		1/5
651 0011	1"1/4		1/5
651 0012	1"1/2		1/4
651 0013	2"		1/4

**6535DN**

Robinet de echilibrare din fonta pentru circuite hidraulice, cu cititor de presiune

i Accesorii: 6535DNISOL - 6535ET - 6536
Piese de schimb: 6535PP - 6535DNMANOP
Pentru coduri vezi pagina 357

Cod	Dimensiune	Pret €	Ambalare
651 0269	DN65		1/1
651 0270	DN80		1/1
651 0271	DN100		1/1
651 0272	DN125		1/1
651 0273	DN150		1/1
651 0274	DN200		1/1

La cerere



6541CC

Robinet de echilibrare dinamică TIEMME-BASIC F/F cu cartuș reglabil intern și conexiuni prize de presiune (opțional)

i Accesorii: 6542PP - 6535ET
Pentru coduri vezi pagina 357

Cod	Corpul supapei	Dimensiunea cartusului	Gama ΔP	Culoare cartus	Debit l/h	Pret €	Ambalare
651 0753	1/2" (DN15)	DN20	20 - 130 kPa	Grey	29 - 155		1/10
651 0754			20 - 130 kPa	Red	207 - 430		1/10
651 0755			20 - 130 kPa	Blue	223 - 526		1/10
651 0756			20 - 130 kPa	Black	162 - 695		1/10
651 0757			20 - 130 kPa	Green	112 - 984		1/10
651 0758			40 - 400 kPa	Grey	42 - 250		1/10
651 0760			40 - 400 kPa	Red	281 - 653		1/10
651 0762			40 - 400 kPa	Blue	203 - 792		1/10
651 0764			40 - 400 kPa	Black	215 - 998		1/10
651 0765			40 - 400 kPa	Green	529 - 1470		1/10
651 0766	3/4" (DN20)	DN20	20 - 130 kPa	Grey	29 - 155		1/10
651 0767			20 - 130 kPa	Red	207 - 430		1/10
651 0768			20 - 130 kPa	Blue	223 - 526		1/10
651 0769			20 - 130 kPa	Black	162 - 695		1/10
651 0770			20 - 130 kPa	Green	112 - 984		1/10
651 0771			40 - 400 kPa	Grey	42 - 250		1/10
651 0772			40 - 400 kPa	Red	281 - 653		1/10
651 0773			40 - 400 kPa	Blue	203 - 792		1/10
651 0774			40 - 400 kPa	Black	215 - 998		1/10
651 0775			40 - 400 kPa	Green	529 - 1470		1/10
651 0776	1" (DN25 small)	DN20	20 - 130 kPa	Grey	29 - 155		1/10
651 0777			20 - 130 kPa	Red	207 - 430		1/10
651 0778			20 - 130 kPa	Blue	223 - 526		1/10
651 0779			20 - 130 kPa	Black	162 - 695		1/10
651 0780			20 - 130 kPa	Green	112 - 984		1/10
651 0781			40 - 400 kPa	Grey	42 - 250		1/10
651 0782			40 - 400 kPa	Red	281 - 653		1/10
651 0783			40 - 400 kPa	Blue	203 - 792		1/10
651 0784			40 - 400 kPa	Black	215 - 998		1/10
651 0785			40 - 400 kPa	Green	529 - 1470		1/10

La cerere





6542CC

Robinet de echilibrare dinamică TIEMME-EASY F/F cu cartuș reglabil extern

i Accesorii: 6543CH - 6535ET
 Piese de schimb: 6542PP
 Pentru coduri vezi pagina 357

Cod	Corpul supapei	Dimensiunea cartusului	Gama ΔP	Culoare cartus	Debit l/h	Pret €	Ambalare
651 0786	1/2" (DN15)	DN20	17 - 210 kPa	■ Black	100 - 412		1/10
651 0787			17 - 210 kPa	■ Green	157 - 609		1/10
651 0788			35 - 400 kPa	■ Black	138 - 615		1/10
651 0789			35 - 400 kPa	■ Green	238 - 896		1/10
651 0790			17 - 200 kPa	■ Red - □ White	276 - 825		1/10
651 0791	3/4" (DN20)	DN20	30 - 400 kPa	■ Red - ■ Grey	406 - 1270		1/10
651 0792			17 - 210 kPa	■ Black	100 - 412		1/10
651 0793			17 - 210 kPa	■ Green	157 - 609		1/10
651 0794			35 - 400 kPa	■ Black	138 - 615		1/10
651 0795			35 - 400 kPa	■ Green	238 - 896		1/10
651 0796	1" (DN25 small)	DN20	17 - 200 kPa	■ Red - □ White	276 - 825		1/10
651 0797			30 - 400 kPa	■ Red - ■ Grey	406 - 1270		1/10
651 0798			17 - 210 kPa	■ Black	100 - 412		1/10
651 0799			17 - 210 kPa	■ Green	157 - 609		1/10
651 0800			35 - 400 kPa	■ Black	138 - 615		1/10
651 0801	1" (DN25 large)	DN40	35 - 400 kPa	■ Green	238 - 896		1/10
651 0802			17 - 200 kPa	■ Red - □ White	276 - 825		1/10
651 0803			30 - 400 kPa	■ Red - ■ Grey	406 - 1270		1/10
651 0804	1"1/4 (DN32)	DN40	17 - 400 kPa	■ Black	535 - 5830		1/4
651 0805	1"1/2 (DN40)	DN50	20 - 400 kPa	□ White	3180 - 16100		1/3
651 0806	2" (DN50)	DN50	20 - 400 kPa	□ White	3180 - 16100		1/3

La cerere



6542CCS

Robinet de echilibrare dinamică TIEMME-AUTO F/F cu cartuș reglabil extern pregătit pentru servomotor

i Accesorii: 6543CH (Per Green 0, Green 1, Green 2) - 6545CH (Per Green 3) - 6542SERV (Per Green 0, Green 1, Green 2)
- 6542SERV2 (Per Green 3) - 6542ATT (Per Green 0, Green 1, Green 2) - 6535ET
Piese de schimb: 6542PP
Pentru coduri vezi pagina 357

Cod	Corpul supapei	Dimensiunea cartusului	Gama ΔP	Culoare cartus	Debit l/h	Pret €	Ambalare
651 0808	1/2" (DN15)	DN20	16 - 200 kPa	Green 0 grey o-ring	37 - 575		1/10
651 0809		DN20	30 - 800 kPa	Green 1 black o-ring	64 - 1110		1/10
651 0810	3/4" (DN20)	DN20	16 - 200 kPa	Green 0 grey o-ring	37 - 575		1/10
651 0811		DN20	30 - 800 kPa	Green 1 black o-ring	64 - 1110		1/10
651 0812	1" (DN25 small)	DN20	16 - 200 kPa	Green 0 grey o-ring	37 - 575		1/10
651 0813		DN20	30 - 800 kPa	Green 1 black o-ring	64 - 1110		1/10
651 1062		DN20	35 - 800 kPa	Green 1HF	620 - 2650		1/10
651 0820	1" (DN25 large)	DN40	16 - 800 kPa	Green 2 black o-ring	865 - 4630		1/8
651 0821	1"1/4 (DN32)	DN40	16 - 800 kPa	Green 2 black o-ring	865 - 4630		1/10
651 0822	1"1/2 (DN40)	-	16 - 400 kPa	Green 3	1900 - 13647		1/1
651 0823	2" (DN50)	-	16 - 400 kPa	Green 3	1900 - 13647		1/1

La cerere

Noutati





6538

Robinet de echilibrare cu reglaj la presiune diferentiala

i Accesorii: 6543CH - 6539 - 6535ET
 Piese de schimb: 6542PP
 Pentru coduri vezi pagina 357

Cod	Corpul supapei	Dimensiunea cartusului	Gama ΔP	Debit l/h	Pret €	Ambalare
651 0626	1/2" (DN15)	DN20	5 - 50 kPa	15 - 2000		1/10
651 0627	3/4" (DN20)	DN20	5 - 50 kPa	15 - 2000		1/10
651 0628	1" (DN25 Small)	DN20	5 - 50 kPa	15 - 2000		1/10
651 0898	1" (DN25 Large)	DN40	5 - 60 kPa	15 - 5980		1/10
651 0629	1"1/4 (DN32)	DN40	5 - 60 kPa	15 - 5980		1/10
651 0630	1"1/2 (DN40)	DN50	5 - 100 kPa	200 - 14000		1/3
651 0631	2" (DN50)	DN50	5 - 100 kPa	200 - 14000		1/3

La cerere



6539

Robinet de echilibrare cu racorduri pentru citirea presiunii

i Accesorii: 6535ET
 Piese de schimb: 6535PP
 Pentru coduri vezi pagina 357

Cod	Dimensiune	Pret €	Ambalare
651 0632	1/2"		1/5
651 0633	3/4"		1/5
651 0634	1"		1/5
651 0635	1"1/4		1/5
651 0636	1"1/2		1/4
651 0637	2"		1/4

6538 - 6539

GHID DE INSTALARE

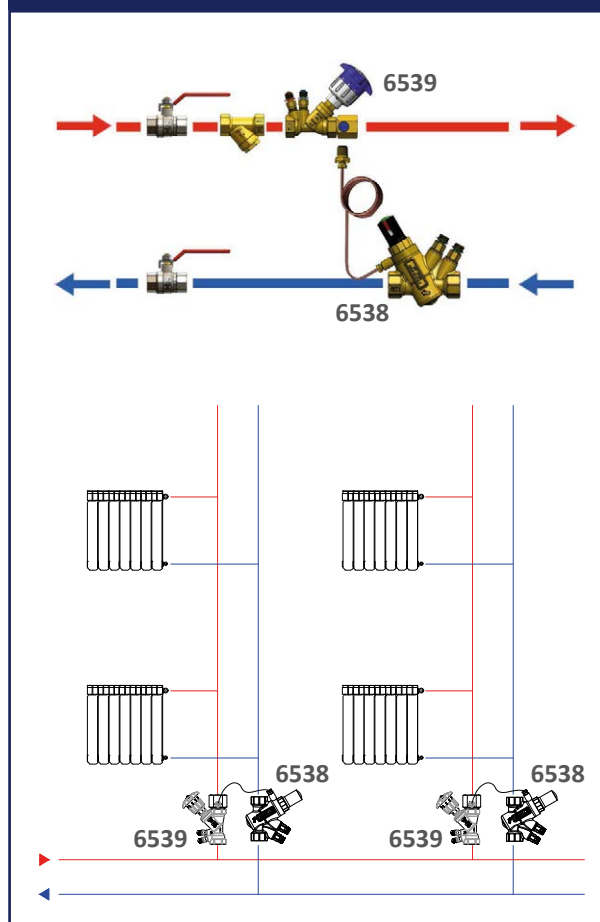



6540

Robinet de echilibrare cu reglaj la presiune diferentia si actuator on/off

i Accesorii: 6543CH - 6542ATT - 6535ET
 Piese de schimb: 6542PP
 Pentru coduri vezi pagina 357

Cod	Dimensiune	Gama ΔP	Debit l/h	Pret €	Ambalare
651 0920	1/2"	3 - 17 kPa	9 - 680		1/10
651 0921	3/4"	3 - 17 kPa	9 - 680		1/10
651 0922	1"	3 - 17 kPa	9 - 680		1/10

6540

GHID DE INSTALARE

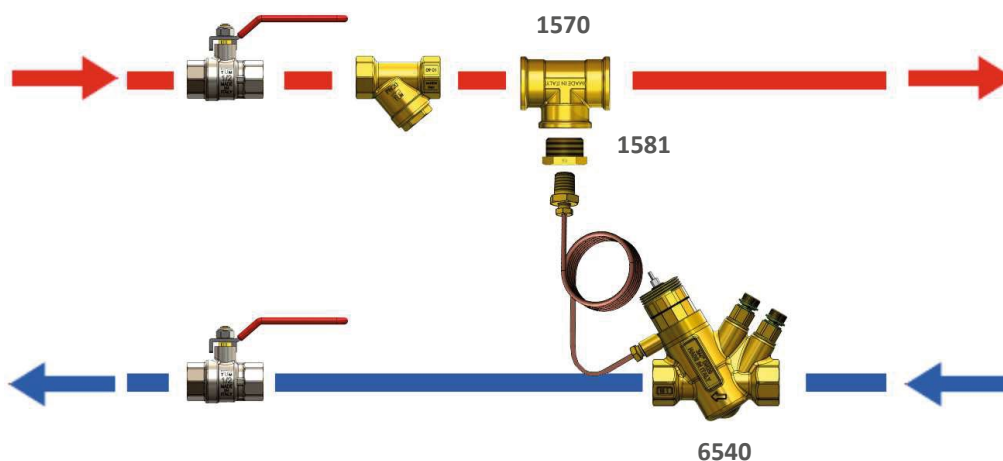

**6535ISOL**

Izolatie din polistiren expandat pentru robinet de echilibrare filetat

i Pentru robinet 6535G

Cod	Dimensiune	Pret €	Ambalare
651 0229	1/2"		1/10
651 0230	3/4"		1/10
651 0231	1"		1/10
651 0232	1"1/4		1/10
651 0233	1"1/2		1/10
651 0234	2"		1/10

**6535DNISOL**

Izolatie din polistiren expandat cu celule inchise pentru robinet de echilibrare art. 6535DN

i Pentru robinet 6535DN

Cod	Dimensiune	Pret €	Ambalare
651 0275	DN65		1/1
651 0276	DN80		1/1
651 0277	DN100		1/1
651 0278	DN125		1/1
651 0279	DN150		1/1
651 0280	DN200		1/1

La cerere

**6535DNMANOP**

Maneta tip rozeta pentru robinetii de echilibrare Art. 6535DN

i Pentru robinet 6535DN

Cod	Dimensiune	Pret €	Ambalare
651 0281	DN65 - DN150		1/1
651 0282	DN200		1/1

La cerere

**6535PP**

Set prize de citit presiunea rosu si albastru

i Pentru robinet 6535G - 6535DN - 6539

Cod	Dimensiune	Pret €	Ambalare
651 0235	1/4"		10/60

**6542PP**

Priză presiune/temperatură pentru robinetii de echilibrare dinamică

i Pentru robinet 6541CC - 6542CC - 6542CCS - 6538 - 6540

Cod	Dimensiune	Pret €	Ambalare
651 0706	1/4"		20/120

**6543CH**

Cheie de reglare pentru cartușe cu reglare externă

i Pentru robinet 6542CC - 6542CCS (Green 0 - Green 1 - Green 2) - 6541DN - 6538 - 6540

Cod	Dimensiune	Pret €	Ambalare
651 0708	-		1/10

**6545CH**

Cheia reglare pentru robinet de echilibrare TM-AUTO DN40-DN50

i Pentru robinet 6542CCS (Green 3)

Cod	Dimensiune	Pret €	Ambalare
651 0870	-		1/10



6542ATT

Servomotor electrotermic pentru robinet de echilibrare TIEMME-AUTO. Conexiune M30x1.5

i Pentru robinet 6542CCS (Green 0 - Green 1 - Green 2) - 6540

Cod	Dimensiune	Pret €	Ambalare
651 0814	NC; on/off (230 Vac)		1/10
651 0815	NC; on/off (24 Vac)		1/10
651 0816	NC; 0÷10V (24 Vac)		1/10

La cerere



6542SERV

Servomotor electric pentru robinet de echilibrare TIEMME-AUTO. Conexiune M30 x 1,5

i Pentru robinet 6542CCS (Green 0 - Green 1 - Green 2)

Cod	Dimensiune	Pret €	Ambalare
651 0817	2 pozitii, reglare în 3 puncte (230 V AC)		1/10
651 0819	0-10 V (24V AC)		1/10



6542SERV2

Servomotor electric pentru supapa de echilibrare TIEMME-AUTO DN40 - DN50. Conexiune M30 x 1,5

i Pentru robinet 6542CCS (Green 3)

Cod	Dimensiune	Pret €	Ambalare
651 0818	Reglare 0-10 V în 2 pozitii, în 3 puncte (24 V AC)		1/10



6536

Manometru diferential digital T550 pentru masurarea presiunii diferentiale și calcularea debitului

Cod	Dimensiune	Pret €	Ambalare
651 0237	-		1/5

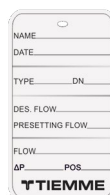

6535ET

Eticheta pentru înregistrarea datelor de setare a robinetului

i Furnizata cu inelul metalic de prindere

Cod	Dimensiune	Pret €	Ambalare
651 0236	-		10/100





3135N

Filtru cu autocuratare cu set de prindere, racorduri exterioare tip olandez M/M

CARACTERISTICI TEHNICE:

- Grad de filtrare: 100 µm
- Materialul paharului colector: policarbonat transparent
- Corp: din alama CW 617N nichelat
- Presiune maxima de exercitiu: 16 bar
- Temperatura maxima de exercitiu: 65°C
- Filete interioare: M/M ISO 228
- Livrat cu manometru si robinet de golire

Cod	Dimensiune	Pret €	Ambalare
313 0002	1/2"		1/5
313 0006	3/4"		1/5
313 0005	1"		1/5
313 0011	1"1/4		1/5



3130N

Filtru cu autocuratare cu set de prindere, racorduri exterioare tip olandez M/M

CARACTERISTICI TEHNICE:

- Grad de filtrare: 100 µm
- Materialul paharului colector: alama CW 617N
- Corp: din alama CW 617N nichelat sau galben
- Presiune maxima de exercitiu: 25 bar
- Temperatura maxima de exercitiu: 95°C
- Filete interioare: M/M ISO 228
- Livrat cu manometru si robinet de golire

 Disponibil si in varianta galbena

Cod	Dimensiune	Pret €	Ambalare
313 0001	1/2"		1/5
313 0003	3/4"		1/5
313 0004	1"		1/5
313 0009	1"1/4		1/5



3136N

Filtru cu autocuratare cu iesiri F/M

CARACTERISTICI TEHNICE:

- Grad de filtrare: 100 µm
- Materialul paharului colector: policarbonat transparent
- Corp: din alama CW 617N nichelat
- Presiune maxima de exercitiu: 16 bar
- Temperatura maxima de exercitiu: 65°C
- Filete interioare: F/M ISO 228
- Livrat cu manometru si robinet de golire

Cod	Dimensiune		Pret €	Ambalare
	F	M		
313 0017	1/2"	x 3/4"		1/5
313 0012	3/4"	x 1"		1/5
313 0015	1"	x 1"1/4		1/5
313 0020	1"1/4	x 1"1/2		1/5



3131N

Filtru cu autocuratare cu iesiri F/M

CARACTERISTICI TEHNICE:

- Grad de filtrare: 100 µm
- Materialul paharului colector: alama CW 617N
- Corp: din alama CW 617N nichelat sau galben
- Presiune maxima de exercitiu: 25 bar
- Temperatura maxima de exercitiu: 95°C
- Filete interioare: F/M ISO 228
- Livrat cu manometru si robinet de golire

 Disponibil si in varianta galbena

Cod	Dimensiune		Pret €	Ambalare
	F	M		
313 0007	1/2"	x 3/4"		1/5
313 0008	3/4"	x 1"		1/5
313 0010	1"	x 1"1/4		1/5
313 0014	1"1/4	x 1"1/2		1/5



3120N
Filtru cu autocuratare cu iesiri F/F

CARACTERISTICI TEHNICE:

- Grad de filtrare: 100 µm
- Materialul paharului colector: alama CW 617N
- Corp: din alama CW 617N nichelat
- Presiune maxima de exercitiu: 16 bar
- Temperatura maxima de exercitiu: 95°C
- Filete interioare: F/F ISO 228
- Livrat cu 2 manometre si robineti de golire

Cod	Dimensiune	Pret €	Ambalare
313 0018	1"1/2		1/6
313 0016	2"		1/8



3145
Kit olandezi pentru filtre cu autocuratare art. 3131-3136

Cod	Dimensiune	Pret €	Ambalare
313 0024	1/2" - 3/4"		1/50
313 0021	3/4" - 1"		1/40
313 0023	1" - 1"1/4		1/30
313 0025	1"1/4 - 1"1/2		1/20



3140
Cartus de schimb pentru filtre cu autocuratare

Cod	Dimensiune	Pret €	Ambalare
313 0013	1/2" - 3/4"		1/50
313 0019	1" - 1"1/4		1/50

3135N - 3130N

OPTIUNI DE ASAMBLARE

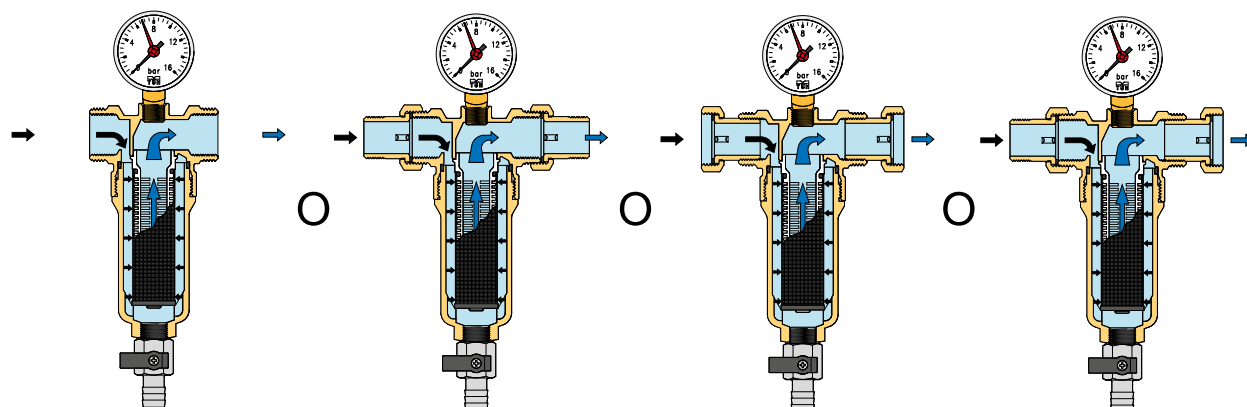

Fara semiolandez si piulita libera

Cu olandez si piulita libera M/M

Cu olandez si piulita libera F/F

Cu olandez si piulita libera M/F





3670
Filtru de impuritati tip "Y"

CARACTERISTICI TEHNICE:

- Grad de filtrare: de la 350 µm la 600 µm in functie de diametru
- Corp: din alama CW 617N
- Presiune maxima de exercitiu: 20 bar pana la 2"; peste 2" 16 bar cealalate
- Temperatura maxima de exercitiu: 100°C
- Filete interioare: F/F ISO 228

Cod	Dimensiune	Pret €	Ambalare
367 0003	1/2"		20/80
367 0001	3/4"		18/54
367 0002	1"		10/30
367 0005	1"1/4		4/16
367 0009	1"1/2		3/12
367 0004	2"		2/8
367 0011	2"1/2		1/8
367 0014	3"		1/5
367 0015	4"		1/1

Capac cu orificiu pentru etansare



3100N
Reductor de presiune cu iesiri F/F

CARACTERISTICI TEHNICE:

- Domeniu de reglare: 1-4 bar (presetat 3 bar)
- Presiune maxima in amonte: 15 bar
- Temperatura maxima de exercitiu: 80°C
- Corp: din alama CW 617N nichelat
- Filete interioare: F/F ISO 228
- Racord pentru manometru: 1/4"F

Cod	Dimensiune	Pret €	Ambalare
318 0021	3/8"		1/50
318 0057	1/2"		1/25
318 0058	3/4"		1/25

Până la terminarea stocului



3110N
Reductor de presiune cu piston si iesiri F/F

CARACTERISTICI TEHNICE:

- Domeniu de reglare: 1-1-5,5 bar (presetat 3 bar)
- Presiune maxima in amonte: 25 bar
- Temperatura maxima de exercitiu: 80°C
- Corp: din alama CW 617N nichelat
- Filete interioare: F/F ISO 228
- Racord pentru manometru: 1/4"F

Cod	Dimensiune	Pret €	Ambalare
318 0008	1/2"		1/10
318 0010	3/4"		1/10
318 0003	1"		1/8
318 0012	1"1/4		1/8
318 0014	1"1/2		1/8
318 0009	2"		1/8
318 0016	2"1/2		1/2
318 0015	3"		1/1
318 0006	4"		1/1



3108N
Reductor de presiune cu piston si racorduri olandez M/M (Presiune maxima in amonte 25bar, domeniu de reglare 1-6 bar si presetat 3 bar)

CARACTERISTICI TEHNICE:

- Domeniu de reglare: 1-5,5 bar (presetat 3 bar)
- Presiune maxima in amonte: 25 bar
- Temperatura maxima de exercitiu: 80°C
- Corp: din alama CW 617N nichelat
- Filete interioare: M/M ISO 228
- Racord pentru manometru: 1/4"F

Cod	Dimensiune	Pret €	Ambalare
318 0068	1/2"		1/10
318 0069	3/4"		1/10
318 0070	1"		1/8
318 0071	1"1/4		1/8
318 0072	1"1/2		1/4
318 0075	2"		1/4



3107N
Reductor de presiune cu piston si racorduri olandez F/F

CARACTERISTICI TEHNICE:

- Domeniu de reglare: 1-1-5,5 bar (presetat 3 bar)
- Presiune maxima in amonte: 25 bar
- Temperatura maxima de exercitiu: 80°C
- Corp: din alama CW 617N nichelat
- Filete interioare: F/F ISO 228
- Racord pentru manometru: 1/4"F

Cod	Dimensiune	Pret €	Ambalare
318 0002	1/2"		1/10
318 0004	3/4"		1/10
318 0011	1"		1/8
318 0019	1"1/4		1/8
318 0020	1"1/2		1/4
318 0018	2"		1/4





3180

Reductor de presiune cu iesiri F/F

CARACTERISTICI TEHNICE:

- Domeniu de reglare: 1-6 bar (presetat 3 bar)
- Presiune maxima in amonte: 16 bar
- Temperatura maxima de exercitiu: 65°C
- Corp: din alama CW 617N nichelat
- Filete interioare: F/F ISO 7/EN 10226
- Racord pentru manometru: 1/4" F

i Pentru cartus de înlocuire vezi 3180C

Cod	Dimensiune	Pret €	Ambalare
318 0017	1/2"		1/10
318 0013	3/4"		1/10



2080

Manometru cu prindere radiala DN50

Cod	Dimensiune	Scara	Pret €	Ambalare
318 0007	1/4"	0 - 6 bar		5/25
318 0025	1/4"	0 - 16 bar		5/25



2080POST

Manometru cu atac posterior



Cod	Dimensiune	Scara	Pret €	Ambalare
192 0017	1/4"	0 - 10 bar		1/40

**4737**

Vana termostatica cromata F pentru apa calda

CARACTERISTICI TEHNICE:

- Conform cu: UNI EN 1111
- Interval de temperatură: 30÷55°C
- Presiune maximă de lucru: 10 bar
- Temperatura maximă de intrare: 90°C
- Material corp: alamă CW617N
- Material capac: PA
- Debit la 3 bar: 30 l/min

Cod	Dimensiune	Pret €	Ambalare
320 0038	1/2"		1/10
320 0037	3/4"		1/10

**4739**

Vana termostatica cromata, racorduri exterioare tip olandez M/M, pentru apa calda

CARACTERISTICI TEHNICE:

- Conform cu: UNI EN 1111
- Interval de temperatură: 30÷55°C
- Presiune maximă de lucru: 10 bar
- Temperatura maximă de intrare: 90°C
- Material corp: alamă CW617N
- Material capac: PA
- Debit la 3 bar: 30 l/min

Cod	Dimensiune	Pret €	Ambalare
320 0039	1/2"		1/10
320 0040	1/2" cu supapă de reținere		1/10

**4738**

Vana de amestec 1" M pentru centrale termice

CARACTERISTICI TEHNICE:

- In conformitate cu Norma Europeana EN 1111
- Corp: din alama CW 602N cromat
- Câmp de reglare a temperaturii: 30 - 55°C
- Temperatura maxima de exercitiu: 10 bar
- Temperatura maxima apa calda: 90°C
- Debit la 3 bar: 72 l/min

Cod	Dimensiune	Pret €	Ambalare
320 0036	3/4"		1/10
320 0001	1"		1/10

**4738KIT01**

Kit semiolandezi pentru vana de amestec 4738

i Setul include: 3 stuturi, 3 piulițe, 3 garnituri

Cod	Dimensiune	Pret €	Ambalare
Pentru 4738 (3/4")			
470 0454	3/4" x 1/2"		1/10
470 0455	3/4" x 1/2" cu supapă de reținere		1/10
470 0475	3/4" x 3/4"		1/10
470 0474	3/4" x 3/4" cu supapă de reținere		1/10
Pentru 4738 (1")			
470 0190	1" x 3/4"		1/10
470 0191	1" x 3/4" cu supapă de reținere		1/10
470 0192	racord din cupru Ø22 compresie		1/10

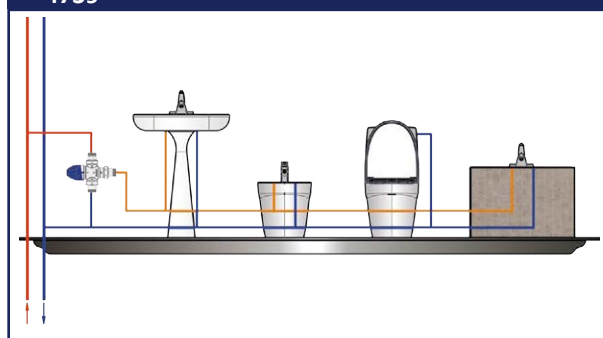
**4737-4738
4739****EXEMPLE DE INSTALARE**

**4738KR**

Kit termostatic anti-oparire cu pompa de recirculare

CARACTERISTICI TEHNICE:

- Vana amestec in conformitate cu: UNI EN 1111
- Câmp temperatura: 30÷55°C
- Temperatura maxima de functionare: 90°C
- Presiune maxima de functionare: 10bar

Cod	Dimensiune	Pret €	Ambalare
320 0002	30÷55°C		1/1

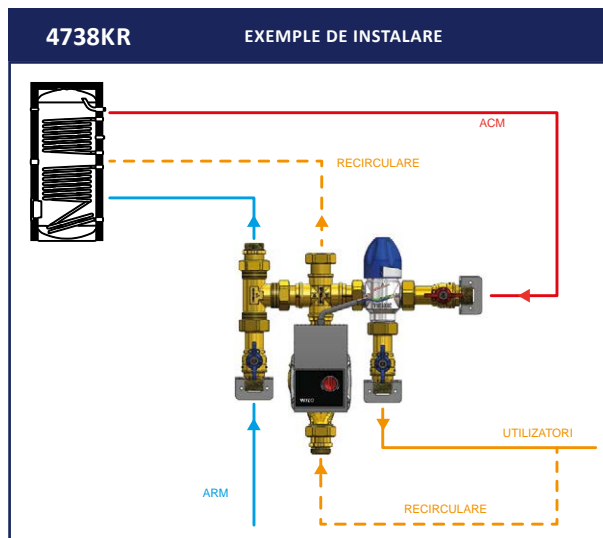



1935
Amortizor lovitura de berbec

CARACTERISTICI TEHNICE:

- Corp: alama CW617N cromata
- Amortizor: polimer cu rezistenta ridicata
- Arc: otel
- Garnituri: EPDM
- Fluidul utilizat: apa
- Presiune max de exercitiu: 10 bar
- Temperatura max a fluidului: 110°C
- Presiune max lovitura de berbec: 50 bar
- Pornire interventie activa: 3 bar
- Racorduri: 1/2" M cu garnitura EPDM

Cod	Dimensiune	Pret €	Ambalare
194 0001	1/2"		1/25

1935

EXEMPLE DE INSTALARE

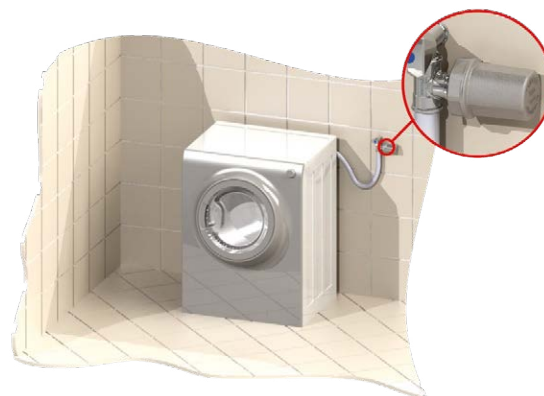



3501

Vana anti-retur cu camera de joasa presiune controlata tip BA

CARACTERISTICI TEHNICE:

- Filet ISO 228
- Material corp: alama CW602N (1/2" - 3/4"); Bronz (> 1")
- Tip BA conform standardului EN 1717
- Împotriva riscurilor de contaminare cu apă până la categoria 4

Cod	Dimensiune	Pret €	Ambalare
350 0296	1/2"		1/1
350 0297	3/4"		1/1
350 0298	1"		1/1
350 0299	1"1/4		1/1
350 0300	1"1/2		1/1
350 0301	2"		1/1

3501

GHID DE INSTALARE

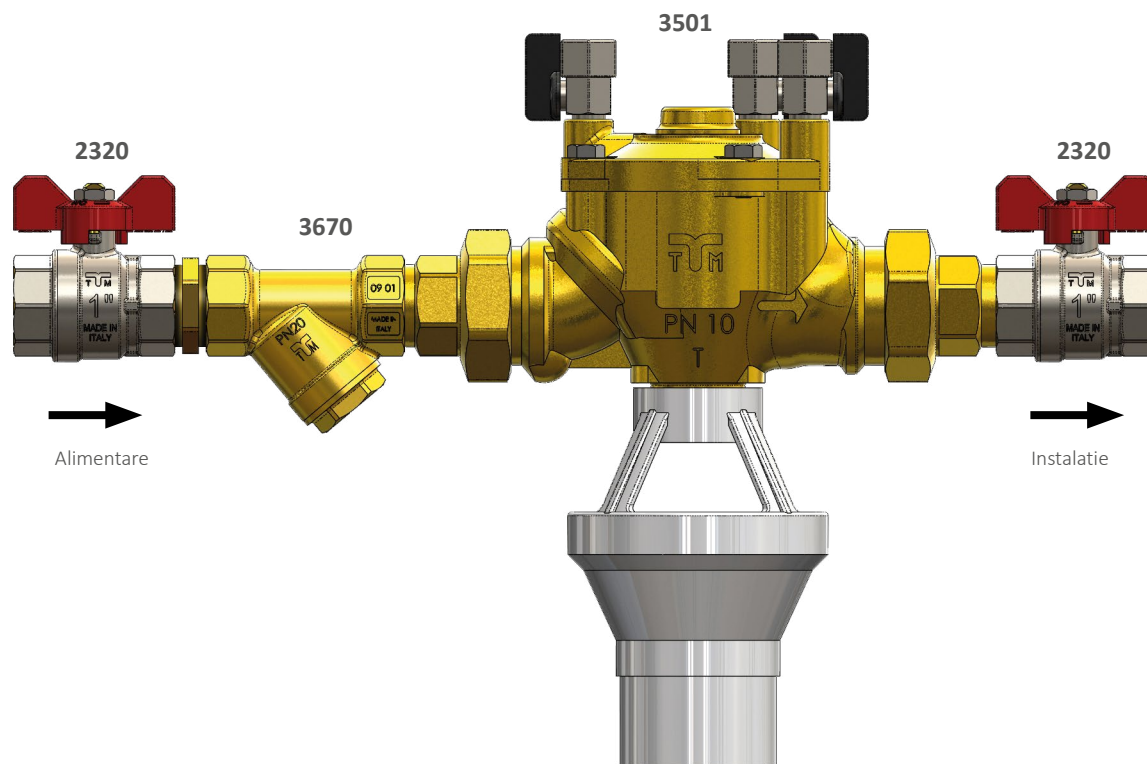

16 SISTEM SOLAR TERMIC CU CIRCULATIE FORTATA PENTRU PRODUCEREA APEI CALDE MENAJERE

Grupuri hidraulice pentru sistemele solare termice  370

Accesorii pentru sistemele solare termice  372

Componente pentru sisteme solare termice  374

Fitinguri cu cuplare rapida "COBRASUN" pentru teava ondulata din otel inoxidabil  379

Racorduri cu prindere rapida "EASYSOLAR"  382

Racorduri pentru teava de cupru si tubul ondulat de otel inox  384

Tub ondulat din otel inox preizolat si accesorii pentru instalare  391



ERC



TSU



**4745**

Grup hidraulic dublu pentru sisteme solare termice cu izolatie inclusa. Versiune cu degazator, robinet cu sfera cu termometru incorporat, grup de siguranta 6 bar si debitmetru mecanic

CARACTERISTICI TEHNICE:

- Dimensiune: DN 25 - 1"
- Conexiuni: 3/4" F
- Presiune maxima: 10 bar
- Temperatura max: 160°C
- Material parti metalice: alama CW 617N
- Material garnituri: EPDM Perox; cauciuc fluorurat
- Material izolatie: polipropilena expandata

TUR

- Masurator / regulator de debit special pentru temperaturi ridicate
- Grup de incarcare / descarcare
- Pompa de circulatie
- Vana de amestec cu filet pentru supapa de siguranta, supapa de sens si termometru
- Supapa de siguranta 6 bar cu manometru

RETUR

- Vana de amestec cu supapa de sens si termometru
- Supapa de aerisire (degazator)

Cod	Pompa de circulatie	Debitmetru	Pret €	Ambalare
470 0315	Fara pompa	1÷10 l/min		1/1
470 0319		8÷30 l/min		1/1
470 0408	Grundfos solar UPM3 15/75	1÷10 l/min		1/1
470 0409		8÷30 l/min		1/1
470 0379	Wilo Para ST 15/7.0	1÷10 l/min		1/1
470 0380		8÷30 l/min		1/1
470 0232	Grundfos solar 15/65	1÷10 l/min		1/1
470 0233		8÷30 l/min		1/1

ErP READY

Disponibila pentru tari non UE

**4745E**

Grup hidraulic dublu pentru sisteme solare termice cu izolatie inclusa. Versiune cu degazator, robinet cu sfera cu termometru incorporat, grup de siguranta 6 bar si debitmetru electronic (Vortex)

**CARACTERISTICI TEHNICE:**

- Dimensiune: DN 25 - 1"
- Conexiuni: 3/4" F
- Presiune maxima: 10 bar
- Temperatura max: 160°C
- Material parti metalice: alama CW 617N
- Material garnituri: EPDM Perox; cauciuc fluorurat
- Material izolatie: polipropilena expandata

TUR

- Masurator / regulator de debit special pentru temperaturi ridicate
- Grup de incarcare / descarcare
- Pompa de circulatie
- Vana de amestec cu filet pentru supapa de siguranta, supapa de sens si termometru
- Supapa de siguranta 6 bar cu manometru

RETUR

- Vana de amestec cu supapa de sens si termometru
- Supapa de aerisire (degazator)

+ DEBITMETRU ELECTRONIC

Cod	Pompa de circulatie	Debitmetru	Pret €	Ambalare
470 0536	Fara pompa	2÷40 l/min		1/1
470 0410	Grundfos solar UPM3 15/75	2÷40 l/min		1/1
470 0381	Wilo Para ST 15/7.0	2÷40 l/min		1/1

ErP READY



**4745R**

Grup hidraulic pentru sisteme solar termice. Izolatie proiectata pentru a proteja controlerul art. 4735E

CARACTERISTICI TEHNICE:

- Dimensiune: DN 25 - 1"
- Conexiuni: 3/4" F
- Presiune maxima: 10 bar
- Temperatura max: 160°C
- Material parti metalice: alama CW 617N
- Material garnituri: EPDM Perox; cauciuc fluorurat
- Material izolatie: polipropilena expandata

Cod	Pompa de circulatie	Debitmetru	Pret €	Ambalare
470 0539	Fara pompa	1÷10 l/min		1/1
470 0540		8÷30 l/min		1/1
470 0416	Wilo Para ST 15/7.0	1÷10 l/min		1/1
470 0417		8÷30 l/min		1/1
470 0275	Grundfos solar 15/65	1÷10 l/min		1/1
470 0276		8÷30 l/min		1/1

ErP READY

Disponibila pentru tari non UE

**4745TRMF**

Grup solar cu pompa Grundfos, debitmetru cu grup de incarcare 1-10 l/min, cu robineti de sectionare cu termometru, grup de siguranta cu manometru si supapa de siguranta 6 bar, fara degazator, iesiri 3/4" feminin

CARACTERISTICI TEHNICE:

- Dimensiune: DN 25 - 1"
- Conexiuni: 3/4" F
- Presiune maxima: 10 bar
- Temperatura max: 160°C
- Material parti metalice: alama CW 617N
- Material garnituri: EPDM Perox; cauciuc fluorurat
- Material izolatie: polipropilena expandata

TUR

- Masurator / regulator de debit special pentru temperaturi ridicate
- Grup de incarcare / descarcare
- Pompa de circulatie
- Vana de amestec cu filet pentru supapa de siguranta, supapă de sens si termometru
- Supapa de siguranta 6 bar cu manometru

RETUR

- Vana de amestec cu supapa de sens si termometru

Cod	Pompa de circulatie	Debitmetru	Pret €	Ambalare
470 0209	Grundfos solar UPM3 15/65	1÷10 l/min		1/1

ErP READY

**4744**

Grup hidraulic mono braț pentru sisteme solare termice cu izolatie inclusa. Versiune cu robinet cu sfera cu termometru incorporat, grup de siguranta 6 bar si debitmetru mecanic

CARACTERISTICI TEHNICE:

- Dimensiune: DN 25 - 1"
- Conexiuni: 3/4" F
- Presiune maxima: 10 bar
- Temperatura max: 160°C
- Material parti metalice: alama CW 617N
- Material garnituri: EPDM Perox; cauciuc fluorurat
- Material izolatie: polipropilena expandata

TUR

- Masurator / regulator de debit special pentru temperaturi ridicate
- Grup de incarcare / descarcare
- Pompa de circulatie
- Vana de amestec cu filet pentru supapa de siguranta, supapă de sens si termometru
- Supapa de siguranta 6 bar cu manometru

Cod	Pompa de circulatie	Debitmetru	Pret €	Ambalare
470 0437	Fara pompa	1÷10 l/min		1/1
470 0411	Grundfos solar UPM3 15/75	1÷10 l/min		1/1
470 0382	Wilo Para ST 15/7.0	1÷10 l/min		1/1
470 0257	Grundfos solar 15/65	1÷10 l/min		1/1

ErP READY

Disponibila pentru tari non UE

**4735E**

Controler electronic diferential programabil pentru sistemele solare, dotat cu display LCD

Cod	Intrari	Sonde	Iesiri	Pret €	Ambalare
470 0516	3	1	2		1/4
470 0517	4	2	3		1/4
470 0518	6	3	4		1/4

Cu intrare pentru debitmetru electronic art. 4749E - 4749FLOWE

**4745C**

Cadru din PPE pentru reglatoarele electronice

Cod	Dimensiune	Pret €	Ambalare
470 0533	Pentru 470 0516		1/10
470 0286	Pentru 470 0517 - 470 0518		1/10
470 0321	ORB		1/10

4745C

CONFIGURAȚII



470 0533



470 0286



470 0321

**4736SONDA**

Sonda de temperatura PT1000, cablu de 2 m siliconat, sonda din oțel 6x25 mm

Cod	Dimensiune	Pret €	Ambalare
470 0027	-		1/50

**4747**

Supapa de aerisire (degazator) pentru grup hidraulic racorduri 3/4" M/M cu O-ring

Cod	Dimensiune	Pret €	Ambalare
470 0057	3/4"		1/20

**4748D**

Grup de siguranta cu manometru 1-10 bar, supapa de siguranta 6 bar

Cod	Dimensiune	Pret €	Ambalare
470 0227	-		1/10

**4749FLOW**

Grup de incarcare / descarcare cu debitmetru mecanic integrat pentru sistemele solare termice

Cod	Dimensiune	Pret €	Ambalare
470 0267	1" F x 3/4" F - 1÷10 l/min		1/5
470 0268	1" F x 3/4" F - 8÷30 l/min		1/5

**4749FLOWE**

Grup de incarcare / descarcare cu debitmetru electronic (Vortex) integrat pentru sistemele solare termice

+ DEBITMETRU ELECTRONIC			
Cod	Dimensiune	Pret €	Ambalare
470 0269	1" F x 3/4" F - 2÷40 l/min		1/5



LISTA DE PREȚURI

**4749E**

Senzor pentru debitmetru electronic

Cod	Dimensiune	Pret €	Ambalare
470 0272	2÷40 l/min		1/5

**4745MANOP**

Maneta cu termometru de imersie pentru grup hidraulic pentru sistemele solare termice

Cod	Dimensiune	Pret €	Ambalare
470 0183	albastru		10/40
470 0184	rosie		10/40

**4712LPS**

Colector solar plan selectiv pentru montare verticala

**CARACTERISTICI TEHNICE:**

- 2 Suprafata totala a colectorului 2,09 m²
- 2 Suprafata de absorbtie 1,92 m²
- Putere maxima 1.325 W
- Temperatura de stagnare 193 °C
- Absorber ALANOD MIROTHERM

Cod	Dimensiune	Pret €	Ambalare
470 0404	2,09 m ²		1/1

**4722KITFX**

Kit pentru montarea a 1 sau 2 colectoare 4712LPS pe acoperisuri plane sau cu inclinare

Cod	Colectoare	Model	Pret €	Ambalare
470 0405	1 (vert.)	4712LPS		10/40
470 0406	2 (vert.)			10/40

**3890PG4**

Pompa de înalta eficienta GRUNDFOS UPM3 SOLAR PM 15/75 cu comanda PWM si interaxa 130 mm

+ POMPE DE INALTA EFICIENTA

Cod	Dimensiune	Pret €	Ambalare
470 0407	Grundfos Solar UPM3 15/75-130		1/1

**3890PW4**

Pompa Wilo Para ST 15/7.0 cu randament mare si comanda PWM. Racorduri 1" si interaxa 130 mm

+ POMPE DE INALTA EFICIENTA

Cod	Dimensiune	Pret €	Ambalare
470 0378	Wilo Para ST 15/7.0		1/1

**3890PG3**

Pompa cu 3 viteze pentru instalatii solare Grundfos Solar 15/65

Cod	Dimensiune	Pret €	Ambalare
470 0224	Grundfos solar 15/65		1/1

Disponibila pentru tari non UE

**2330SUN**

Robinet cu sfera F/F cu maneta de culoare portocalie. Temperatura maxima 180 °C

Cod	Dimensiune	Pret €	Ambalare
472 0012	1/2"		25/100
472 0008	3/4"		15/60
472 0015	1"		10/40

**2162SUN**

Robinet cu capete cupru cu maneta de culoare portocalie. Temperatura maxima 180°C

Cod	Dimensiune	Pret €	Ambalare
472 0074	15		15/60
472 0075	18		15/60
472 0076	22		10/40
472 0077	28		7/28

**2331SUN**

Robinet cu sfera M/F cu maneta de culoare portocalie. Temperatura maxima 180 °C

Cod	Dimensiune	Pret €	Ambalare
472 0018	1/2"		25/100
472 0010	3/4"		15/60
472 0014	1"		10/40

**2371SUN**

Robinet cu sfera M/F cu maneta tip fluture de culoare portocalie. Temperatura maxima 180 °C

Cod	Dimensiune	Pret €	Ambalare
472 0007	1/2"		25/100

**2991SUN**

Robinet cu sfera incarcare/descarcare pentru temperaturi inalte. Racord 1/2" cu O-ring

Cod	Dimensiune	Pret €	Ambalare
472 0019	1/2"		25/100

**3506SUN**

Supapa de sens EUROSTOP F/F ISO228 cu obturator metalic pentru temperaturi inalte

Cod	Dimensiune	Pret €	Ambalare
472 0082	1/2"		15/60
472 0083	3/4"		10/40
472 0084	1"		6/24
472 0085	1"1/4		5/20
472 0086	1"1/2		2/8
472 0087	2"		2/8

**1900SUN**

Supapa automata de aerisire cu O-RING. Temperatura maxima 180°C

Cod	Dimensiune	Pret €	Ambalare
472 0001	1/2"		1/50

**1900KITSUN**

Supapa automata de aerisire cu robinet cu sfera. Temperatura maxima 180°C

Cod	Dimensiune	Pret €	Ambalare
472 0004	1/2"		2/20



1917SUN 1927SUN

Supapa de siguranta pentru sistemele solare termice. Temperatura maxima 160°C. Presiune maxima 10 bar (100KPa). Filet feminin ISO 7

Cod	Dimensiune	Tarare	Pret €	Ambalare
472 0089	1/2" x 1/2"	2,5 bar		1/40
472 0080	1/2" x 3/4"	2,5 bar		1/40
472 0011	1/2" 3/4"	3 bar		1/40
472 0006	1/2" 3/4"	6 bar		1/40



3177XSUN

Grup de siguranta pentru boiler si acumulator pentru sisteme solare termice.

Cod	Dimensiune	Tarare	Pret €	Ambalare
319 0018	3/4" x 3/4"	10 bar		1/20

3177XSUN

EXEMPLU DE APLICARE

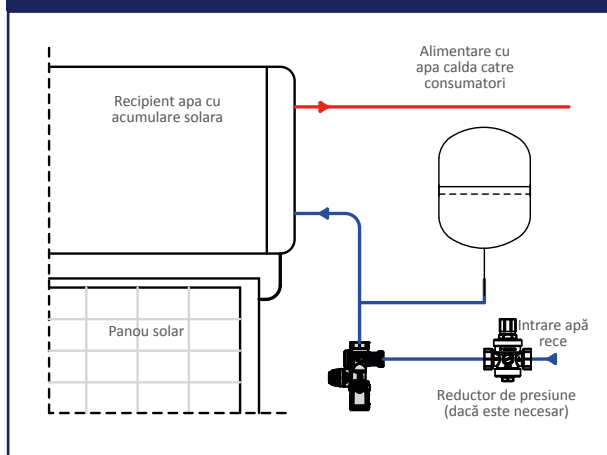

1916SUN

Supapa de siguranta M de temperatura si presiune pentru teava cupru pentru sisteme solare termice.

+ CONTROL TEMPERATURA-PRESIUNE

Cod	Dimensiune	Tarare	Pret €	Ambalare
472 0088	3/4" x 22	10 bar		1/10

**4737SUN**

Vana termostatica cromata F
pentru sistemele solare termice

CARACTERISTICI TEHNICE:

- Conform cu: UNI EN 1111
- Interval de temperatură: 30÷55°C
- Presiune maximă de lucru: 10 bar
- Temperatura maximă de intrare: 100°C
- Material corp: alamă CW617N
- Material capac: PA
- Debit la 3 bar: 30 l/min

Cod	Dimensiune	Pret €	Ambalare
470 0456	1/2"		1/10
470 0457	3/4"		1/10

**4739SUN**

Vana termostatica cromata,
racorduri exterioare tip olandeze
M/M, pentru sistemele solare
termice

CARACTERISTICI TEHNICE:

- Conform cu: UNI EN 1111
- Interval de temperatură: 30÷55°C
- Presiune maximă de lucru: 10 bar
- Temperatura maximă de intrare: 100°C
- Material corp: alamă CW617N
- Material capac: PA
- Debit la 3 bar: 30 l/min

Cod	Dimensiune	Pret €	Ambalare
470 0459	1/2"		1/10
470 0460	1/2" cu supapă de reținere		1/10
470 0476	3/4"		1/10
470 0477	3/4" cu supapă de reținere		1/10

**4738SUN**

Vana termostatica cromata M
pentru sistemele solare termice

CARACTERISTICI TEHNICE:

- Conform cu: UNI EN 1111
- Interval de temperatură: 30÷55°C
- Presiune maximă de lucru: 10 bar
- Temperatura maximă de intrare: 100°C
- Material corp: alamă CW617N
- Material capac: PA
- Debit la 3 bar: 30 l/min (3/4") - 72 l/min (1")

Cod	Dimensiune	Pret €	Ambalare
470 0458	3/4"		1/10
470 0188	1"		1/10

**4738KIT**

Kit semiolandezi pentru vana
termostatica 4738

i Setul include: 3 stuturi, 3 piulițe, 3 garnituri

Cod	Dimensiune	Pret €	Ambalare
Pentru 4738SUN (3/4")			
470 0454	3/4" x 1/2"		1/10
470 0455	3/4" x 1/2" cu supapă de reținere		1/10
470 0475	3/4" x 3/4"		1/10
470 0474	3/4" x 3/4" cu supapă de reținere		1/10
Pentru 4738SUN (1")			
470 0190	1" x 3/4"		1/10
470 0191	1" x 3/4" cu supapă de reținere		1/10
470 0192	racord din cupru Ø22 compresie		1/10



**475KIT**

Kit solar deviator/amestec pentru acumulare apa calda menajera

CARACTERISTICI CONSTRUCTIVE

- Corp: CW617N alamă cromată
- Capace de reglare PA

CARACTERISTICI TEHNICE:**SUPAPA DEVIATOR TERMOSTATIC**

- Temperatura maximă de intrare: +100 ° C
- Presiune maximă de lucru: 10 bar
- Presiune diferențială maximă: 2 bar
- Interval de reglare a temperaturii: +30 ÷ +55 ° C
- Setare din fabrică: +45 ° C
- Precizie: ± 2 ° C
- Compatibilitate cu fluide: apă potabilă

MIXER TERMOSTATIC ANTI-OPARIRE

- Temperatura maximă de intrare: +100 ° C
- Presiune maximă de lucru: 10 bar
- Presiune diferențială maximă: 2 bar
- Interval de reglare a temperaturii: +30 ÷ +55 ° C
- Setare din fabrică: +38 ° C
- Precizie: ± 2 ° C
- Compatibilitate cu fluide: apă potabilă
- Debit la 3 bar: 30 l/min.
- Conformitate: UNI EN 1111

Cod	Dimensiune	Pret €	Ambalare
475 0050	3/4"		1/8

**475KITISOL**

Izolatie pentru kit solar 5 cai deviator si vana termostatica de amestec

Cod	Dimensiune	Pret €	Ambalare
470 0463	475KIT		1/8

475KIT**OPERAȚIUNE**

DIAGRAMA 1: T < Valoare de setare a abaterii



DIAGRAMA 2: T > Valoare de setare a abaterii



**3894VDSUN**

Supapa termostatică de deviere pentru sisteme solare termice.

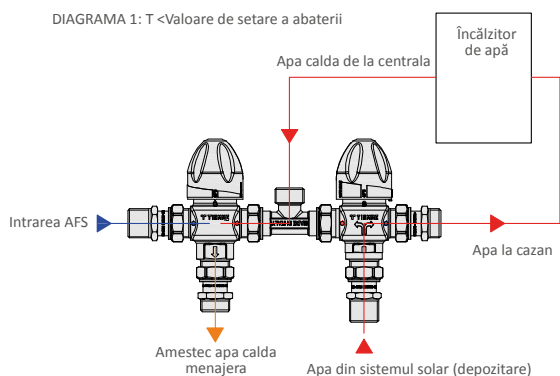
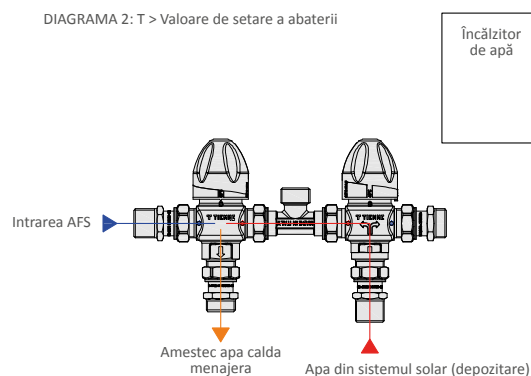
CARACTERISTICI TEHNICE:

- Interval de temperatură: 30 ÷ 55 °C
- Presiune maximă de lucru: 10 bar
- Presiune diferențială maximă: 2 bar
- Temperatura maximă de intrare: 100 °C
- Material corp: alamă CW 617N
- Material buton: PA

Cod	Dimensiune	Pret €	Ambalare
470 0453	3/4"		1/10

**2134SUN**

Robinet cu sfera motorizat cu 3 cai – racorduri cu 3 iesiri



Cod	Dimensiune	Aliment.	Pret €	Ambalare
472 0009	3/4"	230 Vac		1/4
472 0013	1"	230 Vac		1/4

**4730V**

Vas de expansiune presetat la 3 bar

Cod	Dimensiune	Pret €	Ambalare
470 0031	18 l		1/1
470 0045	24 l		1/1
470 0066	35 l		1/1
470 0055	50 l		1/1

**4746KIT**

Kit pentru conectarea vasului de expansiune

Cod	Dimensiune	Pret €	Ambalare
470 0041	3/4"		1/10

**4746**

Racord în unghi drept din trei bucati cu supapa dubla de blocare și izolare pentru vasul de expansiune.

Cod	Dimensiune	Pret €	Ambalare
470 0028	3/4" M - 3/4" F		5/50

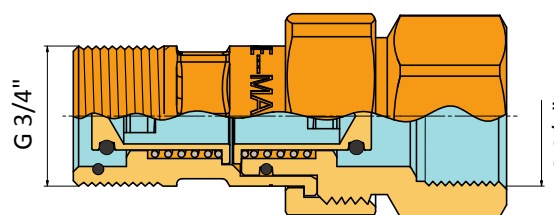
4746 SECȚIUNE**4731ANTIG**

Antigel concentrat pentru sistemele solare

Cod	Litri	Pret €	Ambalare
470 0026	10		1/1





3000X
Racord drept M

BREVETAT

Cod	Dimensiune	Pret €	Ambalare
071 0102	DN12 x 1/2" M		4/40
071 0082	DN12 x 3/4" M		4/40
071 0036	DN16 x 1/2" M		4/40
071 0037	DN16 x 3/4" M		4/40
071 0038	DN16 x 1" M		4/40
071 0039	DN20 x 3/4" M		4/40
071 0040	DN20 x 1" M		4/40
071 0041	DN25 x 1" M		4/40
071 0042	DN25 x 1"1/4 M		4/40
071 0171	DN32 x 1" M		4/40
071 0083	DN32 x 1"1/4 M		4/40
071 0084	DN40 x 1"1/2 M		4/40
071 0085	DN40 x 2" M		4/40



3002X
Racord drept F

BREVETAT

Cod	Dimensiune	Pret €	Ambalare
071 0103	DN12 x 1/2" F		4/40
071 0087	DN12 x 3/4" F		4/40
071 0050	DN16 x 1/2" F		4/40
071 0051	DN16 x 3/4" F		4/40
071 0052	DN16 x 1" F		4/40
071 0053	DN20 x 3/4" F		4/40
071 0054	DN20 x 1" F		4/40
071 0055	DN25 x 1" F		4/40
071 0172	DN32 x 1" F		4/40
071 0088	DN32 x 1"1/4 F		4/40
071 0089	DN40 x 1"1/2 F		4/40
071 0090	DN40 x 2" F		4/40



3001X
Racord drept dublu

BREVETAT

Cod	Dimensiune	Pret €	Ambalare
071 0086	DN12 x DN12		4/40
071 0043	DN16 x DN16		4/40
071 0044	DN20 x DN20		4/40
071 0045	DN25 x DN25		4/40
071 0165	DN32 x DN32		4/40



3001KB
Racord drept dublu INOX/
CUPRU

BREVETAT

Cod	Dimensiune	Pret €	Ambalare
071 0130	DN12x12 (Cu)		4/40
071 0166	DN12x16 (Cu)		4/40
071 0046	DN16 x 15 (Cu)		4/40
071 0047	DN16 x 22/18 (Cu)		4/40
071 0173	DN20 x 15 (Cu)		4/40
071 0048	DN20 x 22/18 (Cu)		4/40
071 0049	DN25 x 22/18 (Cu)		4/40

Furnizati cu ștuț reducție 22-18



3011X
Racord drept INOX/CUPRU

BREVETAT

Cod	Dimensiune	Pret €	Ambalare
071 0174	DN12 x Ø 15		4/40
071 0170	DN12 x Ø 22		4/40
071 0091	DN16 x Ø 18		4/40
071 0056	DN16 x Ø 22		4/40
071 0092	DN20 x Ø 18		4/40
071 0093	DN20 x Ø 22		4/40
071 0094	DN25 x Ø 18		4/40
071 0095	DN25 x Ø 22		4/40
071 0169	DN25 x Ø 28		4/40



3004X
Cot M

BREVETAT

Cod	Dimensiune	Pret €	Ambalare
071 0129	DN16 x 3/4" M		4/40



3005X
Cot F



BREVETAT

Cod	Dimensiune	Pret €	Ambalare
071 0078	DN16 x 3/4" F		4/40



3003KB
Cot dublu INOX/CUPRU

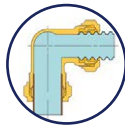

BREVETAT

Cod	Dimensiune	Pret €	Ambalare
071 0159	DN12 x 15 (Cu)		4/40
071 0160	DN12 x 18 (Cu)		4/40
071 0133	DN16 x 18 (Cu)		4/40
071 0079	DN16 x 22 (Cu)		4/40

La cerere



3018KB
COBRASUN Racord cot dublu
Inox/tub din cupru cu set suport
sonda de temperatura (ø 6mm)

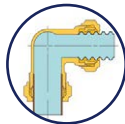

BREVETAT

Cod	Dimensiune	Pret €	Ambalare
071 0167	DN20 x 22 (Cu)		4/40
071 0168	DN25 x 22 (Cu)		4/40



3007KB
Teu CUPRU/INOX/CUPRU



BREVETAT

Cod	Dimensiune	Pret €	Ambalare
071 0080	22 (Cu) x DN16 x 22 (Cu)		4/40



3015
Inel

BREVETAT

Cod	Dimensiune	Pret €	Ambalare
071 0104	DN12		50/1000
071 0105	DN16		50/1000
071 0106	DN20		50/1000
071 0107	DN25		50/1000
071 0155	DN32		50/1000

TABEL DE COMPATIBILITATE TUB ONDULAT DIN OTEL INOXIDABIL

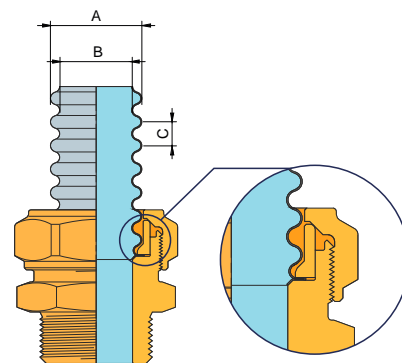

IN TABELUL DE MAI JOS SUNT TRECUTE DIMENSIUNILE DE TEAVA RECOMANDATE:

DN*	A	B	C
12	16,5 ± 0,10	12,5 ± 0,50	4 ± 0,50
16	21,4 ± 0,20	16,8 ± 0,50	5 ± 0,50
20	26,4 ± 0,20	20,8 ± 0,50	5 ± 0,50
25	31,7 ± 0,25	25,5 ± 0,50	5 ± 0,50
32	40,7 ± 0,35	35 ± 0,50	5 ± 0,70
40	49 ± 0,45	40,5 ± 0,50	6,5 ± 0,70

*Pentru alte diametre, contactati departamentul nostru tehnic.

TUTORIAL VIDEO



GHID DE INSTALARE



LISTA DE PRETURI

GHID DE INSTALARE

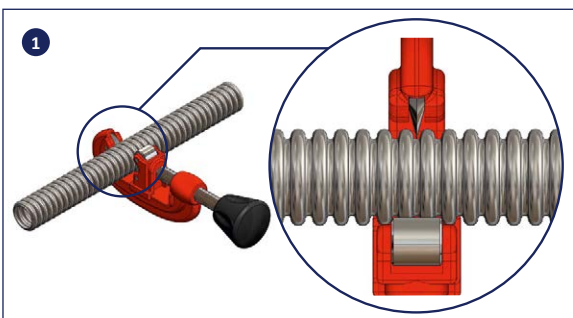

1
 Pozitionati lama in onduleu, perpendicular pe tub.
 Tăietura trebuie să fie curată, fără bavuri

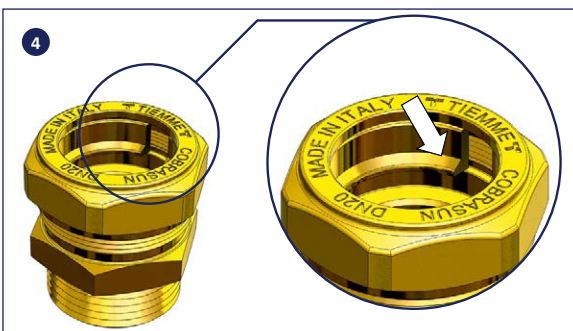

4
 Nu demontati racordul. In cazul dezasamblarii accidentale, trebuie avut grija ca, in momentul reasamblarii șaiba sa fie pozitionata cu fata plana in interiorul niplului.

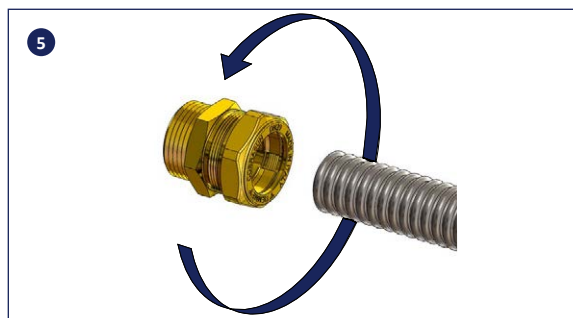

5
 Slabiti manual piulita cu o jumatate de rotatie, in cazul in care nu este deja slabita (fig.5)

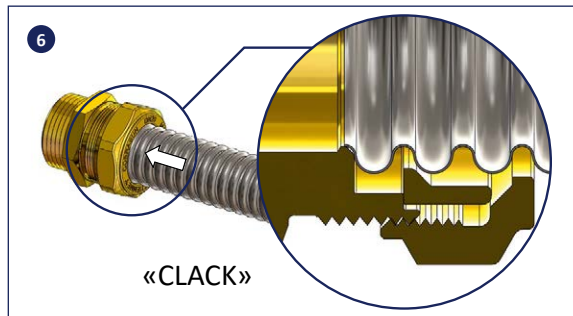

6
 Impingeti tubul in racord pana se aude "CLACK" (fig. 6)

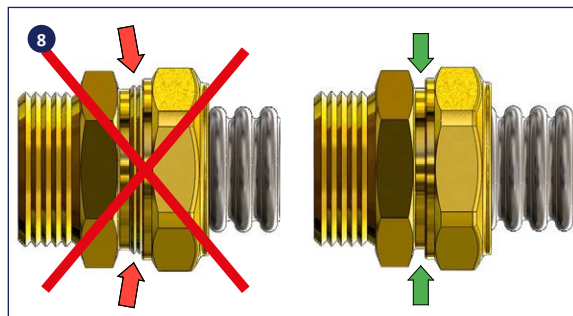
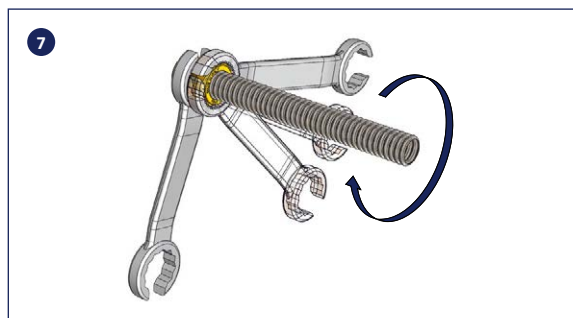

8



3200X
Racord drept M

Cod	Dimensiune	Pret €	Ambalare
071 0057	DN16 x 1/2" M		4/40
071 0058	DN16 x 3/4" M		4/40
071 0059	DN16 x 1" M		4/40
071 0060	DN20 x 3/4" M		4/40
071 0061	DN20 x 1" M		4/40
071 0062	DN25 x 1" M		4/40
071 0063	DN25 x 1"1/4 M		4/40



3202X
Racord drept F

Cod	Dimensiune	Pret €	Ambalare
071 0071	DN16 x 1/2" F		4/40
071 0072	DN16 x 3/4" F		4/40
071 0073	DN16 x 1" F		4/40
071 0074	DN20 x 3/4" F		4/40
071 0075	DN20 x 1" F		4/40
071 0096	DN25 x 3/4" F		4/40
071 0076	DN25 x 1" F		4/40



3201X
Racord drept dublu

Cod	Dimensiune	Pret €	Ambalare
071 0064	DN16 x DN16		4/40
071 0065	DN20 x DN20		4/40
071 0066	DN25 x DN25		4/40



3201KB
Racord drept dublu INOX/
CUPRU

Cod	Dimensiune	Pret €	Ambalare
071 0067	DN16 x 15 (Cu)		4/40
071 0068	DN16 x 22/18 (Cu)		4/40
071 0069	DN20 x 22/18 (Cu)		4/40
071 0070	DN25 x 22/18 (Cu)		4/40

Furnizati cu ștuț reducție 22-18



3211X
Racord drept INOX/tub cilindric

Cod	Dimensiune	Pret €	Ambalare
071 0097	DN16 x Ø 18		4/40
071 0077	DN16 x Ø 22		4/40
071 0098	DN20 x Ø 18		4/40
071 0081	DN20 x Ø 22		4/40
071 0100	DN25 x Ø 18		4/40
071 0101	DN25 x Ø 22		4/40



3204X
Cot M

Cod	Dimensiune	Pret €	Ambalare
071 0035	DN16 x 1/2" M		5/75



3205X
Cot F

Cod	Dimensiune	Pret €	Ambalare
071 0148	DN16 x 1/2" F		5/75
071 0033	DN16 x 3/4" F		5/75





3203KB
Cot dublu INOX/CUPRU

Cod	Dimensiune	Pret €	Ambalare
071 0032	DN16 x 22 (Cu)		5/75

TABEL DE COMPATIBILITATE TUB ONDULAT DIN OTEL INOXIDABIL

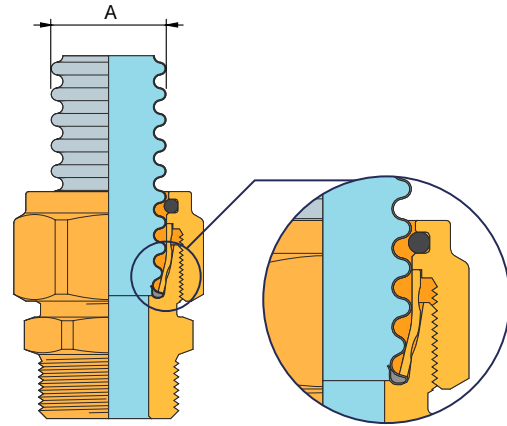

IN TABELUL DE MAI JOS SUNT TRECUTE DIMENSIUNILE DE TEAVA RECOMANDATE:

DN*	A
16	21,4 ± 0,2
20	26,4 ± 0,2
25	31,7 ± 0,25

*Pentru alte diametre, contactati departamentul nostru tehnic.

GHID DE INSTALARE

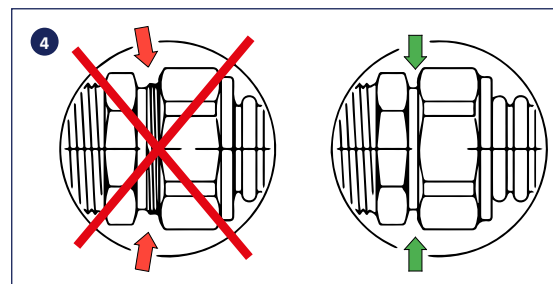
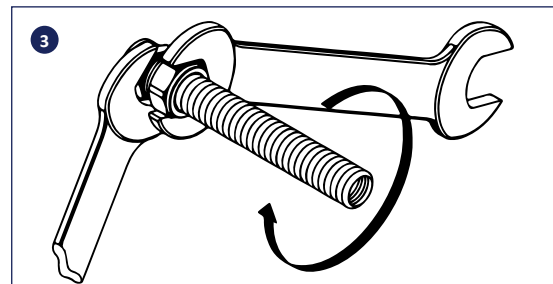
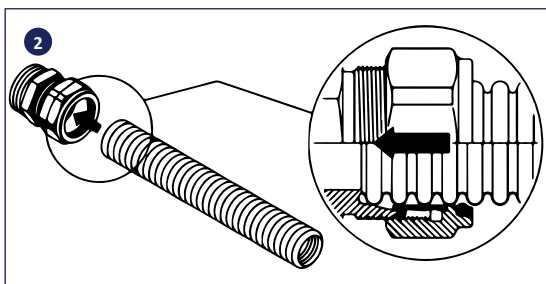
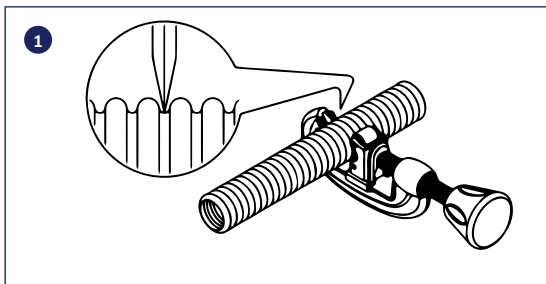

KIT PENTRU CONECTAREA TEVII ONDULATE DE OTEL INOX LA ARMATURI CU FILET MASCULIN FATA PLANA

DESCRIERE

Seturile de conectare art. 1552SET și 8930SET permit o conectare ușoară și rapidă a țevii ondulate din oțel inoxidabil la fittingurile cu filet masculin cu fata plana. Vedeți gama de fittinguri compatibile (marcate cu nota FATA PLANA) prezentată în paginile următoare.

Fittingurile pentru țevi din cupru din seria 1100FD, prin utilizarea kit-ului corespunzător, permit conectarea directă a țevii de cupru/țeavă ondulantă din oțel inoxidabil, asigurând versatilitate și flexibilitate maximă de instalare.

INSTRUCȚIUNI PENTRU ETANSAREA TUBULUI

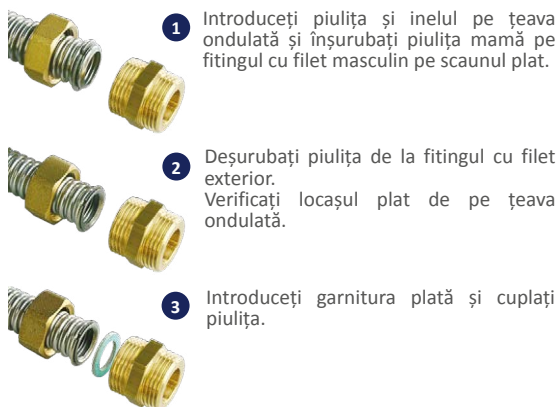

1 Introduceți piulița și inelul pe țeava ondulantă și înșurubați piulița mamă pe fittingul cu filet masculin pe scaunul plat.

2 Deșurubați piulița de la fittingul cu filet exterior. Verificați locașul plat de pe țeava ondulantă.

3 Introduceți garnitura plată și cuplați piulița.

COMPATIBILITATE PENTRU CUPLAREA TUB-RACORD

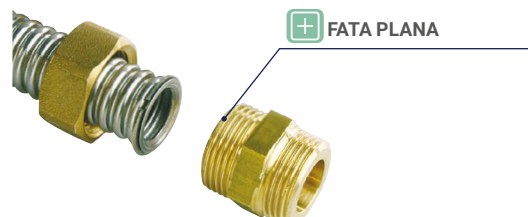

Teava de oțel corugat	Măsurile racord
DN12	1/2"
DN16	3/4"
DN20	1"
DN25	1" 1/4
DN32	1" 1/2



1552SET

Set conectare tuburi din oțel, compus din: 4 piulite, 4 garnituri plate, 4 inele pentru prinderea piulitei pe tub, 2 niple

Cod	Dimensiune	Filet	Pret €	Ambalare
071 0128	DN12	1/2"		1/50
071 0001	DN16	3/4"		1/50
071 0003	DN20	1"		1/25
071 0005	DN25	1" 1/4		1/20
071 0017	DN32	1" 1/2		1/15

Noutati



8930IM

Piulița de strângere pentru tuburi ondulate de oțel

Cod	Dimensiune	Pret €	Ambalare
071 0109	1/2"		10/500
071 0007	3/4"		10/300
071 0012	1"		10/200
071 0014	1" 1/4		10/100
071 0022	1" 1/2		10/100

Noutati



8930SET

Set pentru instalarea tuburilor din oțel ondulant, compus din: 4 piulite, 4 garnituri plate, 4 inele pentru strângerea piulitei pe tub

Cod	Dimensiune	Filet	Pret €	Ambalare
071 0126	DN12	1/2"		1/150
071 0002	DN16	3/4"		1/150
071 0004	DN20	1"		1/100
071 0011	DN25	1" 1/4		1/50
071 0025	DN32	1" 1/2		1/35

Noutati



9341SET

Set garnitura plata si inel pentru tuburi ondulate din oțel

Cod	Dimensiune	Pret €	Ambalare
071 0108	DN12		10/500
071 0008	DN16		10/500
071 0009	DN20		10/500
071 0013	DN25		10/500
071 0027	DN32		10/500

Noutati



**1100FD**

Racord drept piulita si inel pentru teava de cupru, filet masculin, fata dreapta pentru tubul ondulat din otel si garnitura plata

GARNITURA PLATA

Cod	Dimensiune	Pret €	Ambalare
471 0023	15 x 1/2"		10/100
471 0010	15 x 3/4"		5/100
471 0048	16 x 1/2"		10/100
471 0026	18 x 1/2"		10/100
471 0009	18 x 3/4"		5/100
471 0065	18 x 1"		5/100
471 0066	22 x 1/2"		5/100
471 0001	22 x 3/4"		5/100
471 0007	22 x 1"		5/75
471 0042	28 x 1" 1/4		1/50

**1102FD**

Racord drept piulita si inel pentru teava de cupru, filet feminin, fata dreapta

Cod	Dimensiune	Pret €	Ambalare
471 0054	18 x 1/2"		10/100
471 0044	22 x 1/2"		5/100
471 0062	22 x 3/4"		5/100
471 0055	22 x 1"		5/50

**1001
1101**

Conector pentru teava de cupru

Cod	Dimensiune	Pret €	Ambalare
100 0004	15 x 15		10/100
110 0116	16 x 16		10/100
110 0005	18 x 18		10/100
100 0001	22 x 22		5/75
100 0032	28 x 28		5/50

**1552FD**

Niplu fata dreapta si garnitura plata pentru tubul ondulat din otel inox

GARNITURA PLATA

Cod	Dimensiune	Pret €	Ambalare
471 0052	3/8" x 3/8"		25/200
471 0030	1/2" x 1/2"		10/100
471 0003	3/4" x 3/4"		10/100
471 0017	1" x 1"		5/100
471 0085	1" 1/4 x 1" 1/4		5/50
471 0086	1" 1/2 x 1" 1/2		2/30
471 0019	3/4" x 1/2"		10/100
471 0005	1" x 3/4"		5/100
471 0035	1" 1/4 x 1"		5/50
471 0039	1" 1/2 x 1" 1/4		5/50
471 0056	2" x 1" 1/2		2/30

**1552FDR**

Niplu cu fata dreapta la un capat si O-ring la celalalt

GARNITURA PLATA

Cod	Dimensiune	Pret €	Ambalare
471 0004	3/4" x 3/4"		10/100
471 0046	1" x 3/4"		5/100

**1551FD**

Racord drept M/F cu fata dreapta pentru tubul ondulat din otel si garnitura plata

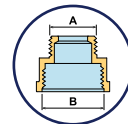

GARNITURA PLATA

Cod	Dimensiune		Pret €	Ambalare
	A	B		
471 0078	3/4" - 1"			10/100

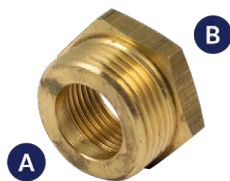
**1581FD**

Reductie M/F cu garnitura plata

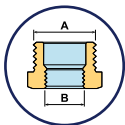

+ GARNITURA PLATA

Cod	Dimensiune A B	Pret €	Ambalare
471 0050	1/2" x 3/8"		25/100
471 0022	3/4" x 1/2"		10/100
471 0079	1" x 1/2"		10/100
471 0012	1" x 3/4"		10/100
471 0038	1" 1/4 x 1"		5/50
471 0111	1" 1/2 x 1"		5/50
471 0043	1" 1/2 x 1" 1/4		5/50
471 0072	2" x 1" 1/2		2/40

**1553FD**

Racord drept de legatura teava cupru / tub ondulat din otel

+ GARNITURA PLATA

Cod	Dimensiune	Pret €	Ambalare
471 0057	Ø 15 - 3/4"		5/100
471 0016	Ø 22 - 3/4"		5/100
471 0036	Ø 22 - 1"		5/100

**1104FD**

Cot piulita si inel pentru teava de cupru, filet masculin, fata dreapta pentru tubul ondulat din otel si garnitura plata

+ GARNITURA PLATA

Cod	Dimensiune	Pret €	Ambalare
471 0113	15 x 1/2"		10/100
471 0021	15 x 3/4"		5/75
471 0059	16 x 3/4"		5/75
471 0006	18 x 3/4"		5/75
471 0002	22 x 3/4"		5/75
471 0032	22 x 1"		5/50

Noutati

**1005
1105**

Cot feminin piulita si inel pentru teava de cupru

Cod	Dimensiune	Pret €	Ambalare
100 0016	15 x 1/2"		10/100
100 0067	15 x 3/4"		5/75
110 0138	16 x 1/2"		10/100
110 0018	18 x 3/4"		5/75
100 0017	22 x 3/4"		5/75
100 0053	22 x 1"		5/50

**1003
1103**

Cot conector pentru teava de cupru

Cod	Dimensiune	Pret €	Ambalare
100 0002	15 x 15		10/100
110 0144	16 x 16		10/100
110 0003	18 x 18		10/100
100 0054	22 x 15		5/100
110 0056	22 x 18		5/75
100 0003	22 x 22		5/75
100 0148	28 x 22		5/50
100 0015	28 x 28		5/25

**1133**

Cot dublu tub din cupru/tub pex

Cod	Dimensiune	Pret €	Ambalare
471 0103	18 (Cu)/18 x 2,5 (Pex)		5/100
471 0067	22 (Cu)/18 x 2,0 (Pex)		5/100
471 0027	22 (Cu)/18 x 2,5 (Pex)		5/100
471 0008	22 (Cu)/22 x 3,0 (Pex)		5/100



**1564FD**

Cot M cu piulita libera si garnitura plata

GARNITURA PLATA

Cod	Dimensiune	Pret €	Ambalare
150 0520	3/4" x 3/4"		5/50

**1039****1139**

Teu F

Cod	Dimensiune	Pret €	Ambalare
100 0062	15 x 15 x 1/2"		10/100
110 0115	18 x 18 x 1/2"		5/70
100 0022	22 x 22 x 1/2"		5/60



3

1007**1107**

Teu pentru tub din cupru

Cod	Dimensiune			Pret €	Ambalare
	1	2	3		
100 0005	15	15	15		10/100
100 0133	15	22	15		5/50
110 0166	16	16	16		10/80
110 0032	18	18	18		5/50
100 0086	22	15	15		5/50
100 0020	22	15	22		5/50
100 0056	22	22	15		5/50
100 0013	22	22	22		5/50
100 0212	22	28	22		5/25
100 0108	28	15	28		5/25
100 0174	28	22	22		5/25
100 0103	28	22	28		5/25
100 0189	28	28	15		5/25
100 0183	28	28	22		5/25
100 0060	28	28	28		5/25

NOU TATI

**1108FD**

Teu M cu fata plana

GARNITURA PLATA

Cod	Dimensiune	Pret €	Ambalare
110 0317	15 x 1/2" x 15		10/100

**1138**

Teu tub din cupru/tub Pex/tub din cupru

Cod	Dimensiune	Pret €	Ambalare
471 0037	22 (Cu)/18 x 2,5 (Pex)/22(Cu)		5/50
471 0025	22 (Cu)/22 x 3,0 (Pex)/22(Cu)		5/50

**1572FD**

Teu masculin cu fata dreapta pentru tubul ondulat de otel si garnitura plata

GARNITURA PLATA

Cod	Dimensiune			Pret €	Ambalare
	1	2	3		
471 0020	1/2"	1/2"	1/2"		10/100
471 0040	3/4"	1/2"	1/2"		5/75
471 0041	3/4"	1/2"	3/4"		5/75
471 0060	3/4"	3/4"	1/2"		5/75
471 0011	3/4"	3/4"	3/4"		5/75
471 0049	1"	3/4"	1"		5/50
471 0084	1"	1"	1"		5/50



1878
Dop M

Cod	Dimensiune	Pret €	Ambalare
150 0273	3/8"		25/200
150 0040	1/2"		25/300
150 0019	3/4"		10/150
150 0077	1"		10/100
150 0222	1" 1/4		5/100
150 0865	1" 1/2		5/50
150 0866	2"		2/40



1035
1135
Dop pentru tub din cupru

Cod	Dimensiune	Pret €	Ambalare
100 0028	15		10/350
110 0027	18		10/220
100 0012	22		5/150
100 0098	28		5/100



1116
Stut de ranforsare pentru tub din cupru

Cod	Dimensiune	Pret €	Ambalare
110 0014	15 x 1,0		50/1300
110 0013	18 x 1,0		100/800
110 0006	22 x 1,0		50/500



1147
1147CZ
Stut reductie

Cod	Dimensiune	Pret €	Ambalare
113 0062	15 x 10		25/900
113 0026	15 x 12		25/900
113 0079	18 x 12		25/750
110 0243	18 x 14		25/750
113 0018	18 x 15		25/750
110 0025	18 x 16		25/750
113 0083	22 x 12		25/500
113 0028	22 x 15		25/500
113 0022	22 x 18		25/500
113 0152	28 x 15		25/300
113 0067	28 x 22		10/300

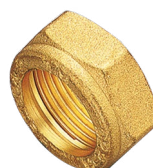

1014
1114
Piulita pentru racord de compresiune pentru tub din cupru

Cod	Dimensiune	Pret €	Ambalare
100 0034	15		50/700
110 0055	18		50/600
100 0035	22		25/400
100 0055	28		25/250



1015
1115
Inel pentru racord de compresiune pentru teava de cupru

Cod	Dimensiune	Pret €	Ambalare
100 0026	15		50/2000
110 0077	18		50/2000
100 0039	22		50/1200
100 0097	28		50/800



**1039S**

Teu cu tub portsonda (sonda \varnothing 6 mm), piulita si inel pentru teava de cupru

Cod	Dimensiune	Lung. sonda	Pret €	Ambalare
471 0064	15 x 15	123 mm		2/10
471 0034	18 x 18	123 mm		2/10
471 0073	18 x 18	164 mm		2/10
471 0024	22 x 22	123 mm		2/10

**1040S**

Teu cu stut portsonda (sonda \varnothing 6 mm), M/M

Cod	Dimensiune	Lung. sonda	Pret €	Ambalare
471 0095	1" x 1"	123 mm		2/10
471 0080	1" x 1"	164 mm		2/10

**1039J**

Teu cu piulita si inel pentru teava de cupru si supapa manuala de aerisire

Cod	Dimensiune	Pret €	Ambalare
471 0063	15 x 15		10/100
471 0047	18 x 18		5/50
471 0013	22 x 22		5/50

**1113KB**

Racord în cruce cu piulită si inel de compresie Pentru tub din cupru, racord cu prindere rapida COBRASUN cu stut port-sondă (sondă \varnothing 6 mm) si supapa de aerisire manual

Cod	Dimensiune	Lung. sonda	Pret €	Ambalare
471 0097	22 x DN16	123 mm		2/10

**1040T**

Teu cu capac M/M

Cod	Dimensiune	Pret €	Ambalare
471 0081	1" x 1"		5/50

**1119FD**

Racord cruce cu filet masculin, fata dreapta pentru tubul ondulat din otel si garnitura plata

GARNITURA PLATA

Cod	Dimensiune	Pret €	Ambalare
471 0045	3/4" x 3/4"		5/50

**1117FD**

Racord cruce cu piulita si inel pentru teava de cupru, filet masculin, fata dreapta pentru tubul ondulat din otel si garnitura plata

GARNITURA PLATA

Cod	Dimensiune	Pret €	Ambalare
471 0033	18 x 3/4"		5/50
471 0014	22 x 3/4"		5/50

**1118**

Cruce cu piulita si inel pentru tub din cupru

Cod	Dimensiune	Pret €	Ambalare
471 0053	18 x 18		5/50
471 0029	22 x 22		5/50

**9561T**

Tub pentru sonda (∅ 6 mm) racord 1/2" cu piulita pentru cupru

Cod	Dimensiune	Pret €	Ambalare
472 0002	123 mm		5/15
472 0005	164 mm		5/15

**3353G**

Supapa manuala de aerisire cu garnitura de cupru

Cod	Dimensiune	Pret €	Ambalare
472 0003	1/2"		10/500

**1900KITSUN**

Supapa automata de aerisire cu robinet cu sfera. Temperatura maxima 180°C

Cod	Dimensiune	Pret €	Ambalare
472 0004	1/2"		2/20

**1117FD-1118
1119FD**

OPTIUNI DE ASAMBLARE

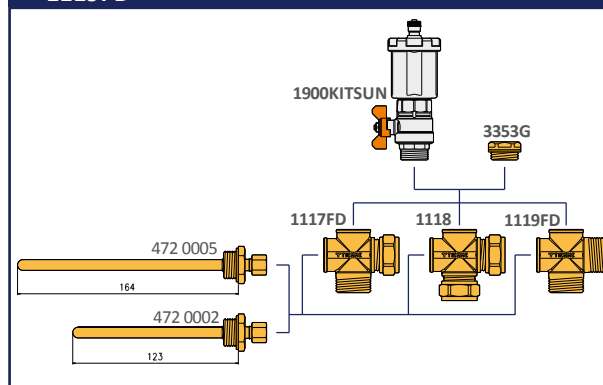

LISTA DE PRETURI

**0700X**

Pereche de tuburi ondulate din oțel inoxid preizolate cu cablu electric pentru conectarea sondei de temperatură la controlerul electronic

Cod	Dimensiune	Pret €/m	Ambalare (m)
070 0008	DN16		10/10
070 0002	DN16		15/15
070 0001	DN16		20/20
070 0004	DN16		25/125
070 0030	DN16		100/100
070 0005	DN20		15/15
070 0003	DN20		20/20
070 0007	DN20		25/125
070 0031	DN20		100/100
070 0006	DN25		20/20

**0720X**

Tub oțel inoxid ondulat

Cod	Dimensiune	Pret €/m	Ambalare (m)
070 0017	DN12 (sp. 0,15)		100/1000
070 0013	DN16 (sp. 0,18)		100/1000
070 0014	DN20 (sp. 0,18)		100/1000
070 0015	DN25 (sp. 0,22)		50/500
070 0018	DN32 (sp. 0,22)		25/375

**0721X**

Tub ondulat din oțel inoxid în izolație termică

Cod	Dimensiune	Pret €/m	Ambalare (m)
070 0016	DN16		50/250

**0705COL**

Set 4 coliere ovale pentru fixarea pe perete a perechii de tuburi ondulate din oțel inoxid

Cod	Dimensiune	Pret €	Ambalare
071 0006	DN16		1/20
071 0010	DN20		1/20
071 0015	DN25		1/20

17 CONTORIZARE DIRECTA MODULE TERMICE

Modul termic HEAT-EVO cu 1 schimbator de caldura



394

Modul termic HEAT-EVO5 cu 1 schimbator de caldura



398

Modul termic HEAT-DUAL1 cu 2 schimbatoare de caldura



401

CE

INTRODUCERE

Modul termic pentru incalzire, cu productie instantanee de ACM prin intermediul unui schimbator de caldura si, optional, conexiune pentru recirculare. Echipat cu vana de echilibrare dinamica, vana deviatoare cu 3 cai pentru prioritate sanitara si izolație. Este unul dintre cele mai utilizate sisteme pentru masurarea energiei combinate cu producția de ACM.

Modulele HEAT-EVO sunt izolate si disponibile in 5 versiuni, cu urmatoarele configuratii:

- **HEAT-EVO1:** Modul termic cu iesire pentru incalzire la temperaturi joase (pentru sisteme radiante), pompa pentru incalzire și pompa de recirculare ACM
- **HEAT-EVO2:** Modul termic cu iesire pentru incalzire la temperatura joasa (pentru sistemele radiante) și pompa pentru incalzire
- **HEAT-EVO3:** Modul termic cu iesire pentru incalzire la temperaturi inalte (pentru radiatoare) si pompa de recirculare ACM
- **HEAT-EVO4:** Modul termic cu iesire pentru incalzire la temperaturi inalte (pentru radiatoare)
- **HEAT-EVO1DYN:** Modul termic cu iesire pentru incalzire la temperaturi joase (pentru sisteme radiante), pompa pentru incalzire și pompa de recirculare ACM. Modelul este echipat cu o vana de echilibrare cu control diferential al presiunii pe linia primara și echilibrare dinamica pe conducta de apa calda menajera.

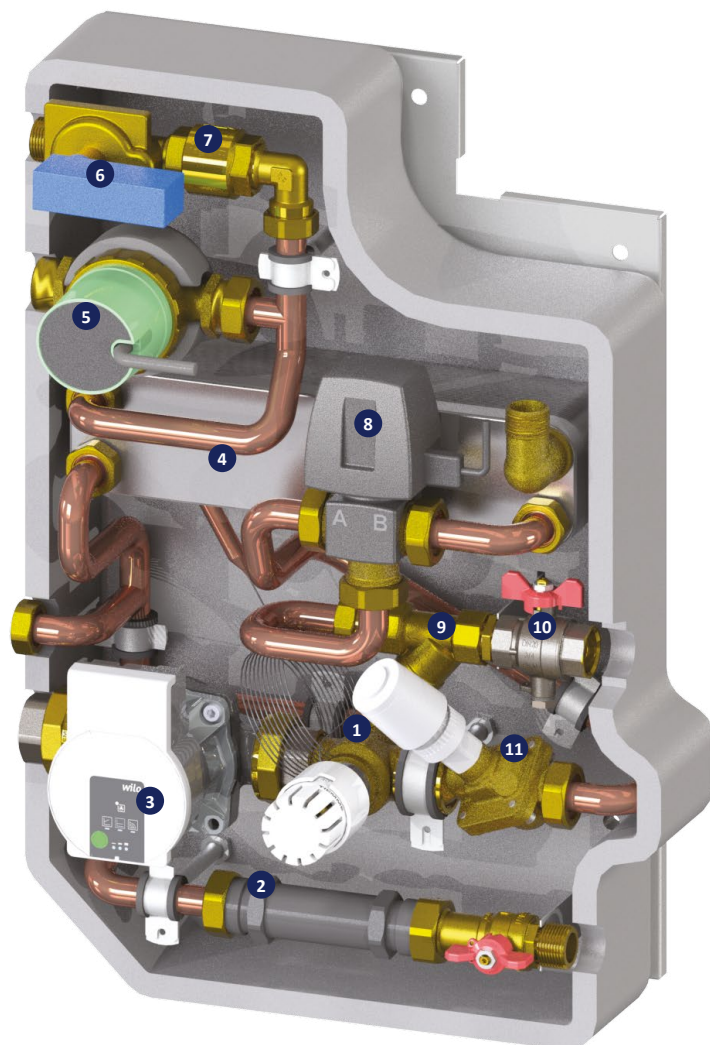

1. Vana termostatica de amestec
2. Pre-echipare pentru instalarea contorului de energie
3. Pompa de incalzire
4. Schimbator de caldura
5. Pompa de recirculare
6. Fluxostat

7. Supapa de sens
8. Vana deviatoare motorizata cu 3 cai
9. Filtru "Y" de impuritati
10. Robinet cu sfera cu port sonda
11. Vana de echilibrare dinamica cu actuator ON/OFF



COMPONENTE PENTRU INSTALARE

NOUȚĂȚI

**HEAT-EVO1**

Modul termic cu ieșire pentru încălzire la temperaturi joase (pentru sisteme radiante), pompa pentru încălzire și pompa de recirculare ACM

DESCRIERE

- Schimbator de caldura in placi 53 kW
- Vana prioritara pentru circuitul de apa calda menajera
- Pompă de recirculare a apei calde menajere
- Vana de echilibrare dinamica (reglare 180÷1080 l/h) echipata cu actuator normal-inchis cu control on/off (alimentare 230 Vac)
- "Pre-instalare" pentru testarea și/sau operatiunile de spalare a sistemului și instalarea ulterioara a contorului de energie termica cu lungime de 130 mm, DN20 (3/4")
- Filtrul "Y" elimina impuritatile
- Vana de amestec cu punct fix (reglare 20÷50 °C)
- Pompa de incalzire
- Fitinguri din cupru pentru conectarea componentelor
- Carcasa de izolație
- Placa metalica pentru montarea pe perete

Cod	Tip	Pret €	Conf.
650 0636	53 kW		1/1

NOUȚĂȚI

**HEAT-EVO2**

Modul termic cu ieșire pentru încălzire la temperatura joasa (pentru sistemele radiante) și pompa pentru încălzire

DESCRIERE

- Schimbator de caldura in placi 53 kW
- Vana prioritara pentru circuitul de apa calda menajera
- Vana de echilibrare dinamica (reglare 180÷1080 l/h) echipata cu actuator normal-inchis cu control on/off (alimentare 230 Vac)
- "Pre-instalare" pentru testarea și/sau operatiunile de spalare a sistemului și instalarea ulterioara a contorului de energie termica cu lungime de 130 mm, DN20 (3/4")
- Filtrul "Y" elimina impuritatile
- Vana de amestec cu punct fix (reglare 20÷50 °C)
- Pompa de incalzire
- Fitinguri din cupru pentru conectarea componentelor
- Carcasa de izolație
- Placa metalica pentru montarea pe perete

Cod	Tip	Pret €	Conf.
650 0637	53 kW		1/1

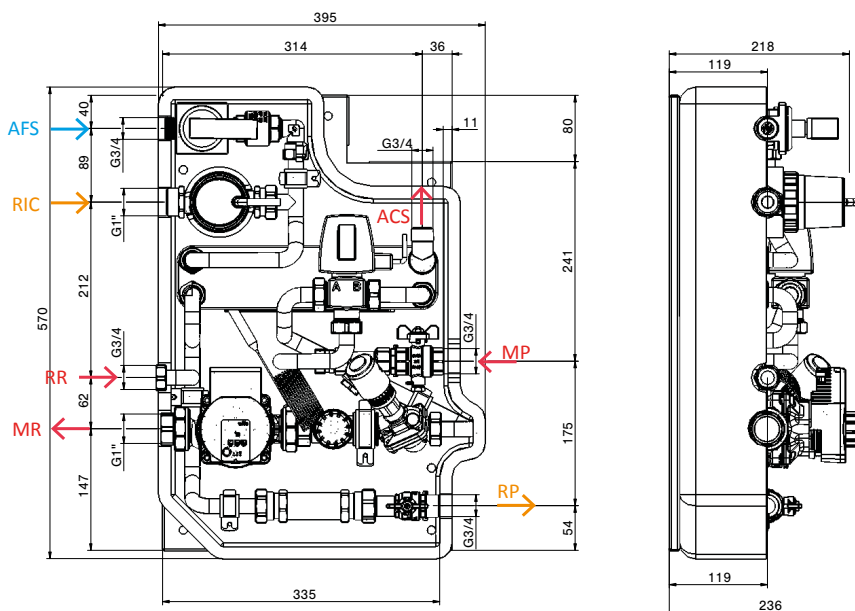
**HEAT-EVO1
HEAT-EVO2****SCHEMA DIMENSIONALA
SCHEMA FUNCTIONALA**

Sigla	Descriere
ACS	Apa calda menajera
AFS	Apa rece sanitară
RIC	Recirculare (doar HEAT-EVO1)
MR	Tur incalzire

Sigla	Descriere
RR	Retur incalzire
MP	Tur primar
RP	Retur primar

COMPONENTE PENTRU INSTALARE

NOUȚĂȚI

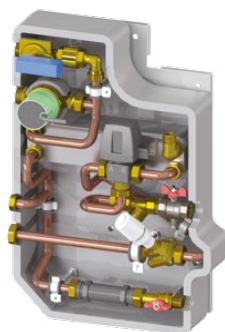
**HEAT-EVO3**

Modul termic cu ieșire pentru încălzire la temperaturi înalte (pentru radiatoare) și pompa de recirculare ACM

DESCRIERE

- Schimbator de caldura in placi 53 kW
- Vana prioritara pentru circuitul de apa calda menajera
- **Pompă de recirculare a apei calde menajere**
- Vana de echilibrare dinamica (reglare 180÷1080 l/h) echipata cu actuator normal-inchis cu control on/off (alimentare 230 Vac)
- "Pre-instalare" pentru testarea și/sau operatiunile de spalare a sistemului și instalarea ulterioara a contorului de energie termica cu lungime de 130 mm, DN20 (3/4")
- Filtrul "Y" elimina impuritatile
- Fitinguri din cupru pentru conectarea componentelor
- Carcasa de izolație
- Placa metalica pentru montarea pe perete

Cod	Tip	Pret €	Conf.
650 0638	53 kW		1/1

NOUȚĂȚI

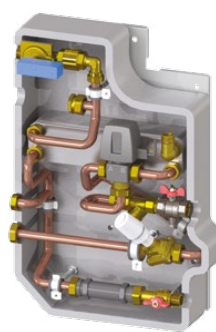
**HEAT-EVO4**

Modul termic cu ieșire pentru încălzire la temperaturi înalte (pentru radiatoare)

DESCRIERE

- Schimbator de caldura in placi 53 kW
- Vana prioritara pentru circuitul de apa calda menajera
- Vana de echilibrare dinamica (reglare 180÷1080 l/h) echipata cu actuator normal-inchis cu control on/off (alimentare 230 Vac)
- "Pre-instalare" pentru testarea și/sau operatiunile de spalare a sistemului și instalarea ulterioara a contorului de energie termica cu lungime de 130 mm, DN20 (3/4")
- Filtrul "Y" elimina impuritatile
- Fitinguri din cupru pentru conectarea componentelor
- Carcasa de izolație
- Placa metalica pentru montarea pe perete

Cod	Tip	Pret €	Conf.
650 0639	53 kW		1/1

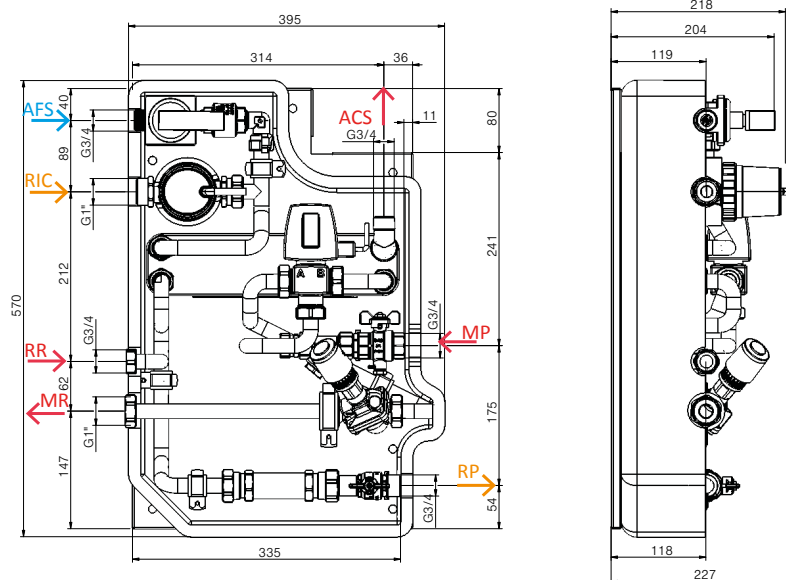
**HEAT-EVO3
HEAT-EVO4****SCHEMA DIMENSIONALA
SCHEMA FUNCTIONALA**

Sigla	Descriere
ACS	Apa calda menajera
AFS	Apa rece sanitară
RIC	Recirculare (doar HEAT-EVO3)
MR	Tur încălzire

Sigla	Descriere
RR	Retur încălzire
MP	Tur primar
RP	Retur primar



NOUȚĂȚI

**HEAT-EVO1DYN**

Modul termic cu iesire pentru incalzire la temperaturi joase (pentru sisteme radiante), pompa pentru incalzire și pompa de recirculare ACM; echipat cu o vana de echilibrare cu control diferential al presiunii pe linia primara și echilibrare dinamica pe conducta de apa calda menajera

DESCRIERE

- Schimbator de caldura in placi 53 kW
- Vana prioritara pentru circuitul de apa calda menajera
- **Pompă de recirculare a apei calde menajere**
- Vana de echilibrare dinamica (reglare ΔP 10÷25 kPa / 65÷920 l/h) echipata cu actuator normal-inchis cu control on/off (alimentare 230 Vac)
- Vana de echilibrare dinamica pe conducta sanitara (reglare 529÷1470 l/h)
- "Pre-instalare" pentru testarea și/sau operatiunile de spalare a sistemului și instalarea ulterioara a contorului de energie termica cu lungime de 130 mm, DN20 (3/4")
- Filtrul "Y" elimina impuritatile
- Vana de amestec cu punct fix (reglare 20÷50 °C)
- Pompa de incalzire
- Fitinguri din cupru pentru conectarea componentelor
- Carcasa de izolație
- Placa metalica pentru montarea pe perete

Cod	Tip	Pret €	Conf.
650 0688	53 kW		1/1

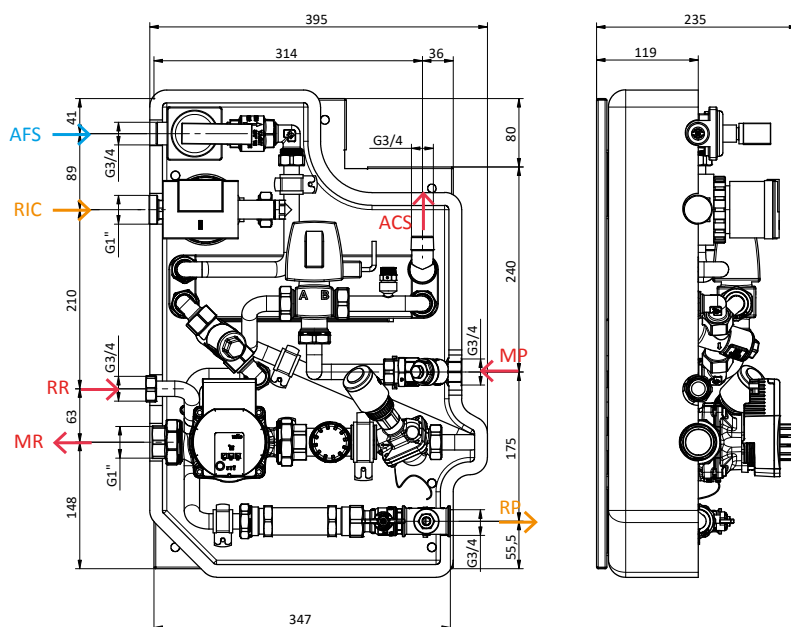
HEAT-EVO1DYN**SCHEMA DIMENSIONALA
SCHEMA FUNCTIONALA**

Sigla	Descriere
ACS	Apa calda menajera
AFS	Apa rece sanitara
RIC	Recirculare
MR	Tur incalzire

Sigla	Descriere
RR	Retur incalzire
MP	Tur primar
RP	Retur primar

INTRODUCERE

Modulul termic HEAT-EVO5 combina trei functii intr-un singur dispozitiv:

GESTIONAREA SISTEMULUI DE INCALZIRE: o vana de amestec permite furnizarea de incalzire prin pardoseala cu un interval de temperatura de 20-50°C; o vana de echilibrare cu control al presiunii diferentiale mentine un Δp constant pe partea generatorului.

PRODUCTIA DE APA CALDA MENAJERA: realizata cu ajutorul unui schimbator de caldura in placi din otel inoxidabil, puterea obtinuta prin ajustarea proportionala a debitului pe schimbatorul primar de caldura; in functie de temperatura și debitul necesar sistemului de apa calda menajera, temperatura este reglata cu ajutorul capului termostatic.

CONTORIZARE: modul conceput pentru instalarea ulterioara a unui contor de apa rece și a unui contor de energie, configuratia hidraulica permite acestora din urma sa masoare energia folosita atat pentru incalzire, cat și pentru partea sanitara.

Modulul termic HEAT-EVO5, proiectat special pentru apartamente si case individuale, este deosebit de compact si instalat integral pe o placa prevazuta cu fante pentru pereti.

1. Placa metalica sau cutie incastrata montata pe perete
2. Schimbator de caldura in placi
3. Carcasa de izolatie a schimbatorului de caldura
4. Deviator/vana de amestec cu 3 cai
5. Cap termostatic cu sonda la distanta
6. Pompa de circulatie pentru incalzire
7. Vana echilibrare dinamica cu control al presiunii diferentiale
8. Filtru "Y" cu portsonda de temperatura
9. Supapa de sens
10. Pre-echipare pentru contor energie termica si apa rece
11. Aerisitor manual

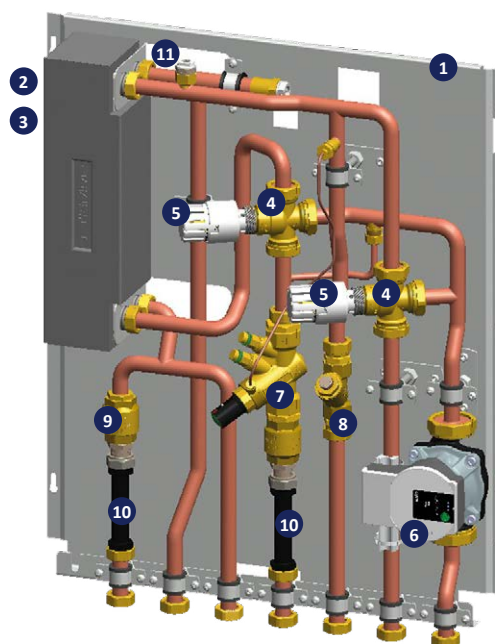

HEAT-EVO5

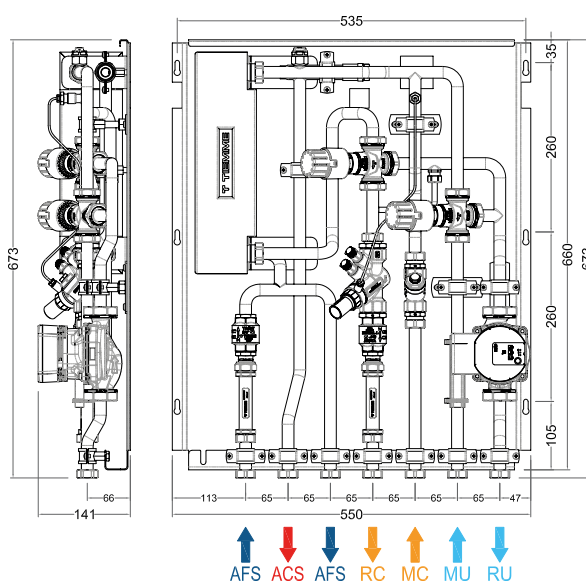
SCHEMA DIMENSIONALA
SCHEMA FUNCTIONALA

Sigla	Descriere
Mc	Tur centrala termica
Rc	Retur centrala termica
Mu	Tur incalzire
Ru	Retur incalzire
ACS	Apa calda menajera
AFS	Apa rece sanitara



NOUȚĂȚI



HEAT-EVO5

Modul termic de contorizare, incalzire și producere de ACM, asamblat pe o placă prevăzută cu fante pentru montare pe perete. Control al sistemului de incalzire prin pardoseala cu reglare între 20 – 50 °C. Producție de apă caldă menajera (ACM) prin schimbătorul de căldură în plăci din oțel inoxidabil. Reglaje pe partea de incalzire și partea sanitară cu capetele termostactice. Contorizarea energiei termice și a apei reci sanitare

DESCRIERE

- Placă metalică pentru instalare directă într-o nișă sau compartiment tehnic: 660x535 mm
- Vană de amestec cu 3 cai pentru reglarea sistemului de incalzire și a temperaturii apei calde menajere
- Capete termostactice cu sonda la distanță pentru ajustarea temperaturilor sistemului de incalzire și a apei calde menajere
- Schimbător de căldură în plăci 53 kW
- Filtru "Y" cu stut pentru sonda de temperatură, cu conexiune M10x1
- Vană de echilibrare dinamică cu control diferențial al presiunii, cu tub capilar (reglare 8÷30 l/min)
- Pre-echipare pentru testare și/sau operațiuni de spălare a instalației și instalarea ulterioară a contoarelor de energie termică și apă rece.

Cod	Dimensiune	Pret €	Ambalare
650 0700	53 kW - fara kit robineti		1/1
650 0732	53 kW - cu kit robineti		1/1



1937

Cutie încadrată pentru modulul termic HEAT-EVO5, completă cu capac și cadru telescopic, din tablă vopsită în alb, RAL 9010. Pregătită pentru a instala kitul de robineti de închidere și șablonul pentru kitul de robineti HEAT-DUAL5K

CARACTERISTICI TEHNICE

- Cutie metalică din oțel galvanizat, completă cu cadru și capac vopsit în alb, RAL 9010

Cod	Dimensiune	Pret €	Ambalare
181 0293	700x850x140÷170 mm		1/1

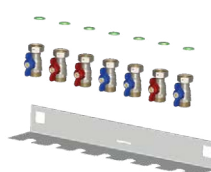

HEAT-DUAL5K

Kit robineti de închidere cu conexiune 3/4" M, complet cu șablon de fixare

Cod	Dimensiune	Pret €	Ambalare
651 1099	3/4" M		1/1

ACCESORII



6560CW 6560C

Contor de energie termica compact, mono jet, pentru citire locala, citire la distanta M-Bus și citire wireless.



Cod	Masura	Tip	Pret €	Conf.
651 0020	DN15 (3/4") qp = 1,5 m ³ /h	Citare locala		1/6
651 0021	DN15 (3/4") qp = 1,5 m ³ /h	Citare cablu M-Bus		1/6
651 0491	DN15 (3/4") qp = 1,5 m ³ /h	Citare wireless M-Bus		1/6



6560CUW 6568C

Contor de energie termica compact **cu ultrasunete**, pentru citire locala, citire la distanta M-Bus și citire wireless.



Cod	Masura	Tip	Pret €	Conf.
651 0600	DN15 (3/4") qp = 1,5 m ³ /h	Citare locala		1/1
651 0055	DN15 (3/4") qp = 1,5 m ³ /h	Citare cablu M-Bus		1/1
651 0493	DN15 (3/4") qp = 1,5 m ³ /h	Citare wireless M-Bus		1/6



6561C

Contor mono jet pentru apa calda sau rece, cu citire locala sau la distanta M-Bus



Cod	Masura	Tip	Pret €	Conf.
651 0024	DN15 (3/4") Q3 = 2,5 m ³ /h	apa calda sau rece		1/12



6561E

Cablu emitor de impulsuri.
1/10 impuls/litru



Cod	Tip	Pret €	Conf.
651 0085	pentru 6561C		1/10



6561CR 6561HR

Contor mono jet pentru apa calda sau rece, cu citire locala sau la distanta wireless



Cod	Masura	Tip	Pret €	Conf.
651 0484	DN15 (3/4") Q3 = 2,5 m ³ /h	apa calda sau rece		1/12



6561MM

Modul compact M-Bus



Cod	Tip	Pret €	Conf.
651 0934	pt 6561CR - 6561HR		1/50



6561MR

Modul radio compact cu senzor wireless inductiv integrat 868 MHz Wireless M-Bus



Cod	Tip	Pret €	Conf.
651 0486	pt 6561CR - 6561HR		1/40



INTRODUCERE

HEAT-DUAL1 este un modul termic ce permite gestionarea sistemului de incalzire, producția instantanee de apa calda menajera (ACM) și masurarea energiei termice, avand ca principala caracteristica separarea agentului termic primar de cel secundar. Aceste caracteristici il fac cea mai eficienta solutie în cazul utilizatorilor deserviti de sisteme centralizate cu temperaturi ridicate sau presiuni statice incompatibile cu sistemul domestic ce trebuie gestionat sau, in cazul combinarii cu sisteme de termoficare, fara a fi nevoie de interpunerea de statii suplimentare. Caracteristicile sunt completate prin amplasarea modului in interiorul unui dulap compact, gata sa fie incastrat in perete.

- Separare hidraulica între agentul termic primar și cel secundar
- Utilizare în sisteme centralizate cu temperaturi/presiuni ridicate în combinație cu diverse sisteme de producere ACM
- Producere instantanee de ACM, fara stocare în camera centralei termice, rezultand economii semnificative de spatiu
- Risc redus de dezvoltare a bacteriei Legionella
- Preincalzirea schimbatorului de apa calda menajera pentru apa calda disponibila imediat
- Reglare a temperaturii de incalzire cu punct fix (30÷75°C)
- Functie de aerisire a sistemului
- Contorizarea consumului pentru incalzire și producere de ACM

1. Vas de expansiune
2. Supapa de siguranta
3. Schimbator in placi (incalzire)
4. Pompa circulatie pentru incalzire
5. Robinet de umplere (incalzire)
6. Schimbator in placi (ACM)
7. Filtru cu sita și portsonda pentru circuit primar
8. Manometru (incalzire)
9. Fluxostat (ACM)
10. Pre-echipare contor energie termica
11. Automatizare – controller electronic
12. Vana deviatoare motorizata incalzire/ACM
13. Vana echilibrare dinamica și control PICV
14. Placa suport

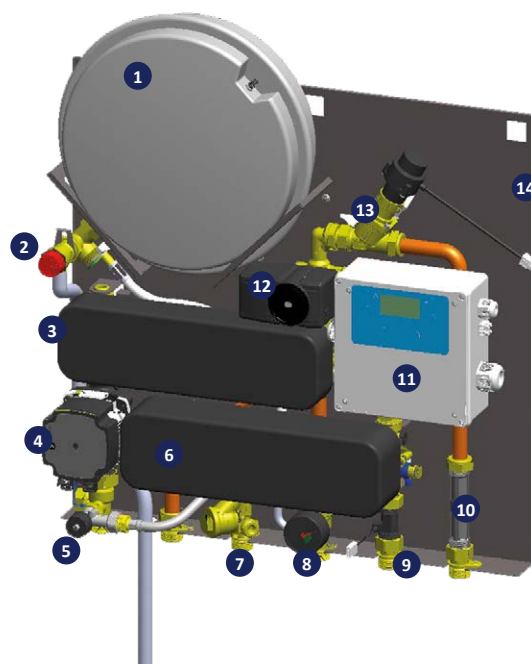

HEAT-DUAL1

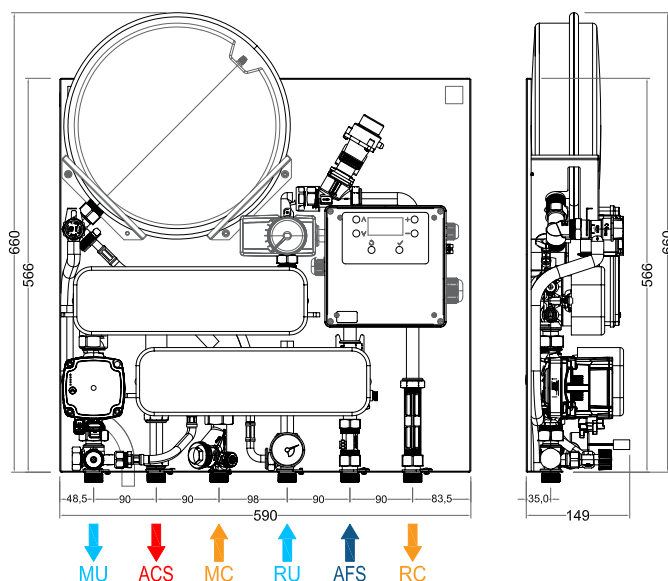
SCHEMA DIMENSIONALA
SCHEMA FUNCTIONALA

Sigla	Descriere
Mc	Tur centrala termica
Rc	Retur centrala termica
Mu	Tur incalzire
Ru	Retur incalzire
ACS	Apa calda menajera
AFS	Apa rece sanitara

NOUȚĂȚI

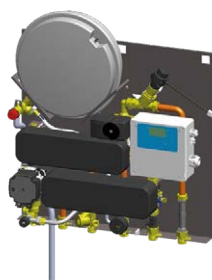

HEAT-DUAL1

Modul termic de contorizare, incalzire și producere de ACM. Solutie eficienta în cazul utilizatorilor deserviti de sisteme centralizate cu temperaturi ridicate sau presiuni statice incompatibile cu sistemul domestic ce urmeaza a fi gestionat. Caracteristica principala: separarea agentului primar de cel secundar

DESCRIERE

- Asamblare pe o placa metalica, dimensiuni 564.5x590 mm pentru instalare directa în nisa, compartiment tehnic sau carcasat într-o cutie de perete (optional)
- Schimbator de caldura în placi pentru circuitul de incalzire, putere nominala 32 kW
- Schimbator de caldura în placi pentru circuit de producție instantanee a apei calde menajere (ACM), putere nominala 75 kW
- Supapa de siguranta pentru circuitul sanitar
- Vana de echilibrare dinamica și control PICV pentru controlul debitului
- Fluxostat și vana deviatoare pentru gestionarea prioritatii de producere a apei, pentru circuitul de incalzire sau cel de ACM.
- Pompa de circulatie pentru circuitul secundar de incalzire
- Controller electronic pentru gestionarea functiilor și calculul curbelor de optimizare și echilibrarea fluxului la schimbatoarele de caldura
- Pre-echipare pentru testarea și/sau spalarea sistemului și instalarea ulterioara a contorului de energie termica.
- Sablon din otel galvanizat pentru fixarea robinetilor de inchidere la baza cutiei.

Cod	Tip	Pret €	Conf.
650 0755	Putere incalzire 32 kW Putere ACM 75 kW		1/1



1937

Cutie incastrata pentru modulul termic HEAT-DUAL1, completa cu capac și cadru telescopic din tabla vopsita în alb, RAL 9010. Pregatita pentru a acomoda kitul de robineti de inchidere și sablonul pentru kitul de robineti HEAT-DUAL1K

CARACTERISTICI TEHNICE

- Cutie metalica din otel galvanizat, completa cu capac și cadru telescopic din tabla vopsita în alb, RAL 9010.

Cod	Tip	Pret €	Conf.
181 0293	700x850x140÷170 mm		1/1

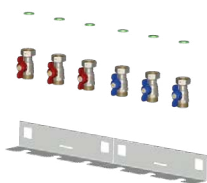

HEAT-DUAL1K

Kit robineti de inchidere cu conexiune 3/4" M, complet cu sablon de fixare

Cod	Tip	Pret €	Conf.
651 1063	3/4" M		1/1



6560CW 6560C

Contor de energie termica compact, mono jet, pentru citire locala, citire la distanță M-Bus și citire wireless



Cod	Masura	Tip	Pret €	Conf.
651 0020	DN15 (3/4") qp = 1,5 m³/h	Citare locala		1/6
651 0021	DN15 (3/4") qp = 1,5 m³/h	Citare cablu M-Bus		1/6
651 0491	DN15 (3/4") qp = 1,5 m³/h	Citare wireless M-Bus		1/6



6560CUW 6568C

Contor de energie termica compact cu ultrasunete, pentru citire locala, citire la distanță M-Bus și citire wireless



Cod	Masura	Tip	Pret €	Conf.
651 0600	DN15 (3/4") qp = 1,5 m³/h	Citare locala		1/1
651 0055	DN15 (3/4") qp = 1,5 m³/h	Citare cablu M-Bus		1/1
651 0493	DN15 (3/4") qp = 1,5 m³/h	Citare wireless M-Bus		1/6



LISTA DE PREȚURI



CERTIFICAT DE CALITATE

TIEMME RACCORDERIE S.p.A.

Producator al sistemelor de incalzire in pardoseala,
instalatii sanitare si de gaz, cu sediul in Castegnato (BS)

Via Cavallera 6/A,

in conformitate cu Legea 46/1990 "Norme pentru siguranta instalatiilor"
si cu D.P.R. 447 din 6 decembrie 1991

"Norme de aplicare a Legii 46/1990, privind siguranta instalatiilor"

CERTIFICA

faptul ca toate produsele livrate clientilor sunt proiectate si produse
in conformitate cu normele tehnice si standardele
internationale de calitate
cuprinse in EN ISO 9000.

Calitatea produselor TIEMME a fost recunoscuta de catre prin ISO 9001,
care atesta seriozitatea companiei in perfectionarea,
producerea si comercializarea articolelor din catalog.

Reprezentant Legal

COPIE FACSIMIL

Documentul in original si textul integral al normelor enuntate sunt disponibile la sediul
TIEMME RACCORDERIE S.p.A., Via Cavallera 6/A (loc. Barco) - 25045 - Castegnato (BS)



MINISTERUL DEZVOLTĂRII, LUCRĂRILOR PUBLICE ȘI ADMINISTRAȚIEI
CONSILIUL TEHNIC PERMANENT PENTRU CONSTRUCȚII



Acord Tehnic
017-05/3951-2023

TEVI PE-X₂ ȘI FITINGURI CU ÎMBINARE PRIN PRESARE PENTRU INSTALAȚII
TUYAUX PE-X₂ ET RACCORDS AVEC SERRAGE POUR INSTALLATIONS
PE-X₂ PIPES AND CRIMP FITTINGS FOR NETWORKS
PE-X₂ ROHRE UND MESSINGSFITTINGS FÜR NETZE
Cod categorie 28 și 29

PRODUCĂTOR: TIEMME RACCORDERIE S.P.A.
Via Cavallera 6/A, 25045 Castagnò (DS), ITALIA
tel: 0039030-2142211, fax: 0039030-2142206

TITULAR ACORD/AGREMENT TEHNIC: S.C. TIEMME SYSTEMS S.R.L.
Str. Rădărbuși, nr. 7, Bolintin Deal, județ Giurgiu
tel: 004021-3115160; fax: 004021-3119150

ELABORATOR ACORD/AGREMENT TEHNIC: INSTITUTUL EUROPEAN PENTRU ȘTIINȚE TERMICE
str. Matei Voievod, nr. 29, sector 2, București
ROMÂNIA
tel/fax: 004021-2521157

Grupa specializată nr. 5 - „Produce, procedee și echipamente pentru instalații aferente construcțiilor”

Prezentul acord tehnic este valabil până la data de 28 octombrie 2026 numai însoțit de AVIZUL TEHNIC al Consiliului Tehnic Permanent pentru Construcții și nu înlocuiește certificatul de calitate.



MINISTERUL DEZVOLTĂRII, LUCRĂRILOR PUBLICE ȘI ADMINISTRAȚIEI
CONSILIUL TEHNIC PERMANENT PENTRU CONSTRUCȚII



Acord Tehnic
017-05/3952-2023

FITINGURI METALICE PENTRU INSTALAȚII
METAL FITTINGS FOR INSTALLATIONS
RACCORDS METALLIQUES POUR INSTALLATIONS
METALSCHWITTINGS FÜR NETZE
Cod categorie 28 și 29

PRODUCĂTOR: TIEMME RACCORDERIE S.P.A.
Via Cavallera 6/A, 25045 Castagnò (DS), ITALIA
tel: 0039030-2142211, fax: 0039030-2142206

TITULAR ACORD/AGREMENT TEHNIC: S.C. TIEMME SYSTEMS S.R.L.
Str. Rădărbuși, nr. 7, Bolintin Deal, județ Giurgiu
tel: 004021-3115160; fax: 004021-3119150

ELABORATOR ACORD/AGREMENT TEHNIC: INSTITUTUL EUROPEAN PENTRU ȘTIINȚE TERMICE
str. Matei Voievod, nr. 29, sector 2, București
ROMÂNIA
tel/fax: 004021-2521157

Grupa specializată nr. 5 - „Produce, procedee și echipamente pentru instalații aferente construcțiilor”

Prezentul acord tehnic este valabil până la data de 20 iulie 2026 numai însoțit de AVIZUL TEHNIC al Consiliului Tehnic Permanent pentru Construcții și nu înlocuiește certificatul de calitate.



MINISTERUL DEZVOLTĂRII, LUCRĂRILOR PUBLICE ȘI ADMINISTRAȚIEI
CONSILIUL TEHNIC PERMANENT PENTRU CONSTRUCȚII



Acord Tehnic
017-05/3953-2023

ARMATURI DIN ALAMĂ PENTRU INSTALAȚII DE ÎNCĂLZIRE ȘI RĂCIRE
BRASS VALVES FOR HEATING AND COOLING INSTALLATIONS
TARMATURES EN LAITON POUR INSTALLATIONS DE CHAUFFAGE ET REFRIGEREMENT
MESSING ARMATUREN FÜR HEIZUNG UND NETZE
Cod categorie 28 și 29

PRODUCĂTOR: TIEMME RACCORDERIE S.P.A.
Via Cavallera 6/A, 25045 Castagnò (DS), ITALIA
tel: 0039030-2142211, fax: 0039030-2142206

TITULAR ACORD/AGREMENT TEHNIC: S.C. TIEMME SYSTEMS S.R.L.
Str. Rădărbuși, nr. 7, Bolintin Deal, județ Giurgiu
tel: 004021-3115160; fax: 004021-3119150

ELABORATOR ACORD/AGREMENT TEHNIC: INSTITUTUL EUROPEAN PENTRU ȘTIINȚE TERMICE
str. Matei Voievod, nr. 29, sector 2, București
ROMÂNIA
tel/fax: 004021-2521157

Grupa specializată nr. 5 - „Produce, procedee și echipamente pentru instalații aferente construcțiilor”

Prezentul acord tehnic este valabil până la data de 28 noiembrie 2026 numai însoțit de AVIZUL TEHNIC al Consiliului Tehnic Permanent pentru Construcții și nu înlocuiește certificatul de calitate.



MINISTERUL DEZVOLTĂRII, LUCRĂRILOR PUBLICE ȘI ADMINISTRAȚIEI
CONSILIUL TEHNIC PERMANENT PENTRU CONSTRUCȚII



Acord Tehnic
017-05/3999-2023

TEVI MULTISTRAT ȘI FITINGURI CU ÎMBINARE PRIN PRESARE PENTRU INSTALAȚII DE APĂ ȘI AER
TUYAUX MULTICOUCHEES ET RACCORDS AVEC SERRAGE POUR INSTALLATIONS D'EAU ET AIR
MULTILAYER PIPES AND CRIMP FITTINGS FOR WATER AND AIR NETWORKS
MEHPLAGIG ROHRE UND MESSINGSFITTINGS FÜR WASSER UND LUFT NETZE
Cod categorie 28 și 29

PRODUCĂTOR: TIEMME RACCORDERIE S.P.A.
Via Cavallera 6/A, 25045 Castagnò (DS), ITALIA
tel: 0039030-2142211, fax: 0039030-2142206

TITULAR ACORD/AGREMENT TEHNIC: S.C. TIEMME SYSTEMS S.R.L.
Str. Rădărbuși, nr. 7, Bolintin Deal, județ Giurgiu
tel: 004021-3115160; fax: 004021-3119150

ELABORATOR ACORD/AGREMENT TEHNIC: INSTITUTUL EUROPEAN PENTRU ȘTIINȚE TERMICE
str. Matei Voievod, nr. 29, sector 2, București
ROMÂNIA
tel/fax: 004021-2521157

Grupa specializată nr. 5 - „Produce, procedee și echipamente pentru instalații aferente construcțiilor”

Prezentul acord tehnic este valabil până la data de 28 octombrie 2026 numai însoțit de AVIZUL TEHNIC al Consiliului Tehnic Permanent pentru Construcții și nu înlocuiește certificatul de calitate.



Produsele fabricate de Tiemme Raccorderie S.p.A. (denumita in continuare: Companie) sunt garantate pentru doi ani de la data vanzarii. Aceasta garantie se alatura si nu prejudiciaza drepturile cumparatorului prevazute in Directiva Europeana 99/44/CE si in legislatia nationala de punere in aplicare, cu exceptia cazurilor în care se menționează altfel.

Nu beneficiaza de garantie produsele defecte sau eventualele pagube cauzate de:

- transportul ce nu a fost efectuat in mod direct de catre Companie;
- nerespectarea instructiunilor si avertizarilor prevazute de catre producator in manuale, instructiuni si/sau cataloage de produse;
- nerespectarea normelor si/sau dispozitiilor prevazute in legislatia si/sau regulamentele in vigoare;
- absenta sau neconformitatea lucrurilor de intretinerea periodica, dezinteresul in folosire, incapacitatea de utilizare, interventiile neautorizate;
- instalarea necorespunzatoare si/sau disfunctionalitati de orice fel in alimentarea instalatiilor sanitare, electrice, de alimentare cu combustibil si/sau de evacuare;
- tratarea in mod neadecvat a apei ce alimenteaza instalatia, tratamente de detartrare efectuate in mod eronat;
- corozivitatea cauzata de agresivitatea apei sau a condensului;
- inghet, curenti paraziti si/sau efecte nocive ale descarcarilor electrice atmosferice;
- inlocuiri preventive;
- situatii de forta majora independente de vointa sau controlul Companiei producatoare.

Eventualele defecte ale materialelor, existenta viciilor ascunse, precum si erorile, diferentele de dimensiune ce depasesc tolerantele de fabricatie, vor angaja Compania sa inlocuiasca piesele defecte.

Eventualele returnuri de produse neconforme vor fi acceptate numai dupa autorizarea prelabila in scris (autorizare de retur) din partea Companiei. In orice caz produsele vor fi returnate la sediul Companiei in conditii porto franco, pe cheltuiala clientului. In caz contrar marfa va fi refuzata si returnata expeditorului.

Orice eventual retur de produse conforme va fi autorizat in prelabil de Companie. In acest caz costurile de transport vor fi suportate de catre client. Acoperirea prin polita de asigurare are o durata de 10 ani de la data livrării din fabricile Companiei.

Numai in cazul in care montarea de produse neconforme ale Companiei cauzeaza pagube materiale sau accidente umane, Tiemme va contacta Compania de Asigurari pentru remedierea acestor situatii conform normelor din polita de asigurare. Pentru a demara procedura de despagubire cu Compania de Asigurari, Tiemme trebuie sa primeasca de la clientul respectiv o informare despre incident, in scris, in termen de 10 zile de la aparitia evenimentului. De asemenea trebuie transmise toate informatiile solicitate in chestionarul dosarului de asigurare, informatii referitoare la detaliile producerii evenimentului, atasand toate documentele si probele necesare pentru a se putea gestiona procedura de despagubire, totul in termen de 30 zile.

Nu va fi recunoscuta nicio despagubire clientului inainte ca Tiemme sa verifice cauza reclamatiei si/sau a daunelor.

In cazul in care sunt necesare sau solicitate teste de laborator pentru a verifica, cerceta, defini neconformitatea unui retur/reclamatie/daune, si responsabilitatea nu poate fi atribuita Companiei Tiemme, cheltuielile vor fi suportate de catre solicitant. Instalatorii trebuie sa efectueze si sa documenteze verificarile instalatiilor in conformitate cu reglementarile internationale in vigoare.

S.C. TIEMME SYSTEMS S.R.L.

lesire Autostrada Bucuresti-Pitesti, Km 23, Com. Bolintin Deal, Str. Rasaritului, Nr. 7, Cod Postal 087015, Jud. Giurgiu
Cod Fiscal RO 16557181, Nr. Ord. Reg. Com. J52/16/2015

Vanzarea marfii se face in urma incheierii unui contract de vanzare-cumparare incheiat intre S.C. TIEMME SYSTEMS S.R.L. in calitate de Vanzator si fiecare client in parte, in calitate de Cumparator.

La livrare, marfa va fi insotita de urmatoarele documente:

- instructiuni privind instalarea, punerea in functiune, exploatarea si intretinerea (acolo unde este cazul);
- declaratie de conformitate;
- certificat de garantie pentru produs;
- factura fiscala;
- aviz de insotire a marfii.

Documentele sus-mentionate vor fi redactate in limba romana.

Producele vandute se vor factura la cursul de schimb euro/leu al BNR din ziua emiterii facturii.

Conditiiile de vanzare sunt cele stabilite prin contract.

Daca cumparatorul nu respecta conditiile de vanzare si plata, S.C. TIEMME SYSTEMS S.R.L. isi rezerva dreptul de a suspenda viitoarele livrari.

COMENZI

Comenzile de marfa duc la rezervarea marfii doar in momentul confirmarii de catre client a facturii proforme si nu implica obligativitatea din partea Vanzatorului de a face livrari partiale.

PRETURI

La preturile de lista se pot stabili de comun acord o serie de reduceri pentru fiecare categorie de produse in parte, preturi ce vor fi valabile pana la momentul in care intervin modificari acceptate de ambele parti. Daca nu exista acorduri diverse confirmate in scris de ambele parti, livrarile se vor face la preturile valabile la data livrarii. Preturile de vanzare sunt pentru conditia de livrare FRANCO DEPOZIT VANZATOR.

LIVRARI

Marfa se livreaza in mod normal prin curierat rapid, daca nu exista acorduri diverse intre parti. Marfa va fi transportata sub raspunderea transportatorului chiar si in situatia in care conditia de livrare este FRANCO DESTINATAR.

PLATI

Conditiiile de plata sunt cele inscrise in factura si sunt obligatorii. Orice intarziere in ce priveste termenul de plata se va penaliza fara preaviz cu procentul stipulat in contractul de vanzare cumparare pe fiecare zi de intarziere din suma restanta, pana la data achitarii integrale. Comisioanele bancare de plata intra in totalitate in sarcina clientului.

RECLAMATII

Nu se accepta reclamatii la mai mult de 5 zile lucratoare de la data primirii marfii. Orice reclamatie catre TIEMME se va face in scris si va fi transmisa la sediul nostru.

RETURURI

Nu se accepta returul de marfa fara acordul in prealabil al TIEMME SYSTEMS. Atat cererea de acceptare a returului de marfa cat si acceptul returului se vor face in scris. Marfa returnata se va expedia pe adresa depozitului TIEMME SYSTEMS pe cheltuiala clientului.

SUSPENDAREA COMENZILOR SI FORTA MAJORA

In cazul in care cumparatorul nu a respectat conditiile comerciale concordate, chiar si partial, societatea noastra poate suspenda livrarile ulterioare. Societatea noastra este exonerata de raspunderea contractuala in caz de aparitie a unei situatii de forta majora.

MODIFICARI

TIEMME isi rezerva dreptul de a face, fara notificare, in orice moment si din orice motiv, orice modificari necesare de natura tehnica.

LITIGII

Orice litigii vor fi supuse spre solutionare instantelor judecatoresti competente.

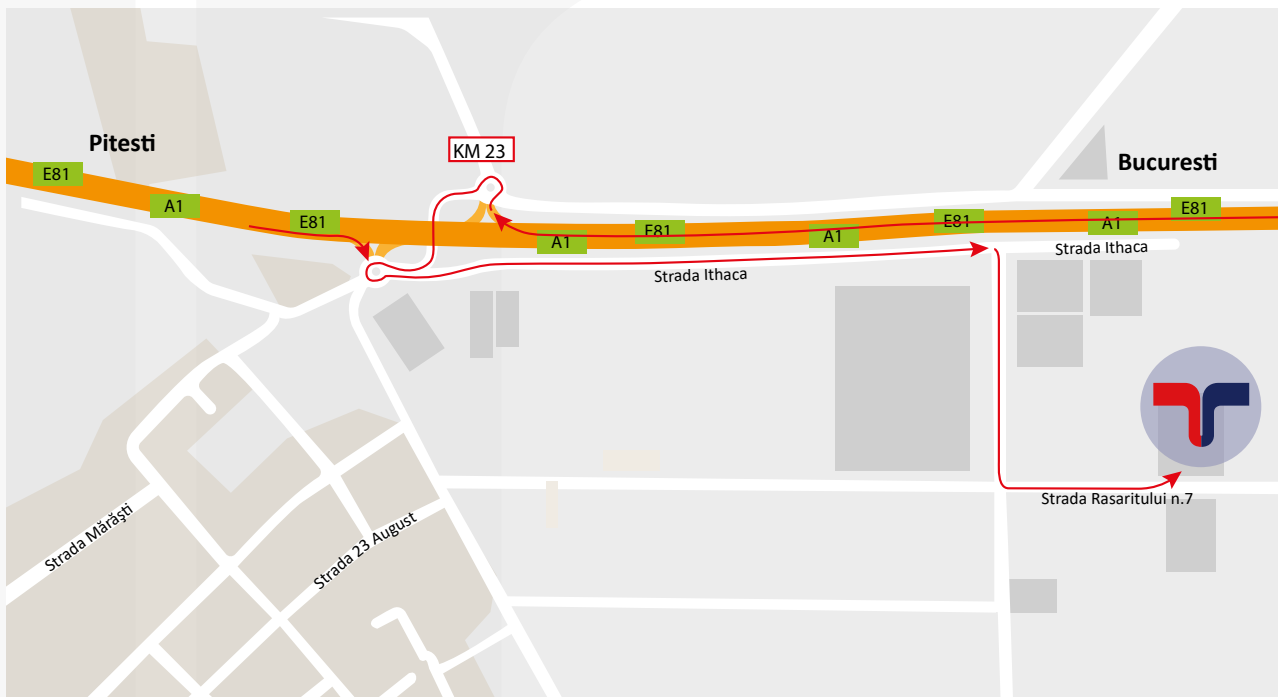

TIEMME SYSTEMS S.R.L.

ieşire Autostrada Bucuresti-Pitesti KM 23
Str. Rasaritului nr. 7 Bolintin-Deal
087015, Jud. Giurgiu

GPS 44°.27'.45" N
25°.50'.43" E

Tel. +40 021-311.51.60 - Fax +40 021-311.91.50

tiemmesystems@tiemme.com
www.tiemme.com

COMPONENTE SI SISTEME INTEGRATE PENTRU INSTALATII HIDRO-TERMO-SANITARE



COMPONENTE HIDRAULICE



CAMERA TEHNICA - CONTORIZARE



SISTEME RADIANTE



BATERII

