

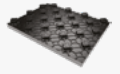

1 **RADIANT FLOOR SYSTEMS**



2 **RADIANT CEILING/WALL SYSTEMS**



3 **RADIANT INDUSTRIAL SYSTEMS**



4 **MANIFOLDS AND MIXING UNITS FOR DISTRIBUTION**



5 **HYDRAULIC SEPARATORS, DISTRIBUTION MANIFOLDS AND PUMPING STATIONS FOR THERMAL PLANTS**



6 **CLIMAV 2.0 BUILDING MANAGEMENT THERMOREGULATION**



7 **TEMPERATURE CONTROLS**



8 **AIR TREATMENT**



**DISCOVER THE
TIEMME RANGE
AND DOWNLOAD THE
TECHNICAL DOCUMENTATION**



MORE INFO

“Everyone, with their skills and experience, has always been essential to our company. It is something precious that paves the way to a better understanding of all Customers’ need, be them in Italy or abroad, through targeted and innovative services and products”.

The President

Giuliano Gnutti

A handwritten signature in black ink, appearing to read 'Giuliano Gnutti', written in a cursive style.



The Gruppo Gnutti has been a leading entrepreneurial business from the 50s, with a well-rooted activity all over the territory. A cluster of companies leaders in the technical-production chain, turning raw material into a fine product. A perfect union between tradition, professionalism, quality, technology and know-how, so to offer the best service, every day.

The Gnutti Group was conceived from the development and growth of the company Gnutti Cirillo S.p.A.



Tiemme Raccorderie was established in the 1980s as a production and marketing company for brass fittings, valves and pipes. It joined the Gruppo Gnutti in 1994, when the company underwent a radical change. The new millennium saw a further phase of growth and evolution for the company through the development of integrated systems in the hvac sector. Horizons were internationalized with the foundation of subsidiaries in Spain, Greece and Romania to meet the needs of a wider and more demanding market.



The production of taps was **Valvosanitaria Bugatti's** main activity since it was founded in 1948 in Lumezzane (BS). Over time, the business focused on producing ball valves and in 1984 moved to the new headquarters in Castegnato. The large warehouse assures an efficient organization of the supplies and speeds up the delivery process. In 2023 Valvosanitaria Bugatti joined the Gruppo Gnutti. Today, the company has gained international recognition for its production of ball valves for water and gas, fittings, taps, and heating system components.



Gnutti Cirillo S.p.A. ounded in 1951 by Cirillo Gnutti, is now the world leader in hot forging and machining of brass and other non-ferrous metals. Gnutti Cirillo S.p.A. has compiled impressive technical expertise, enabling it to meet all requirements. The company is self-sufficient throughout its entire production chain, from design to completely in-house construction of tooling and equipment, from hot forging of brass to machining, surface treatments and automatic assembly up to the packaging of the finished product. Everything is customised to the customer's specifications. Alongside its historical location in Lumezzane (Brescia) in 2000 Gnutti Cirillo S.p.A. opened its new plant in Odolo (Brescia).



The process of internationalisation of the Group has proceeded over the years thanks to the establishment of **Metal Forming Technology Inc.** Located in the state of Michigan (USA) MFT has achieved high levels of efficiency in the production of hot forged and machined brass articles according to the customer's specifications. At the same time the company offers logistic and customer care services on behalf of Gnutti Cirillo S.p.A. to the North American and Canadian markets.



EMC Component is a company founded in 2011, specialized in designing, manufacturing and trading accessories for power and distribution transformers. EMC products originate from an idea or a specific market need. EMC ensures maximum quality and reliability by designing, prototyping, testing, and manufacturing these products in the country, namely made in Italy.



UNI EN ISO 9001:2015



RETTORIA DI CERTIFICAZIONE
CENTRO NAZIONALE

The company is based in Castegnato (Brescia) and operates in two adjacent plants, one of approximately 7.000 m² covered, where the production department with transfer machines and offices are located, the other with an area of 15.000 m² where the warehouses and the PEX department for the production of the cross-linked polyethylene pipe are located.

Tiemme Raccorderie® Quality System is the tool to make sure that all customers get products and services meeting their expectations for constant high quality and punctuality in delivery, in a process of continuous improvement, in full respect of safety and the environment.

In 1999 TIEMME Raccorderie® S.p.A. obtained the ISO 9002 certification of its quality system and in 2003 the ISO 9001 certification, natural consequence of the total quality policy and achievement of the excellence as pursued by the company. Addition to the high-quality manufacture, Tiemme Raccorderie® products are tested, controlled and recognized all over the world by more than 70 of the most prestigious certification bodies. Efficient and modern service of trained technicians is fully available to our customers.

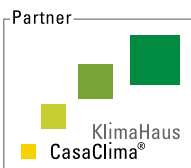



ROMANIA

Branch office
Bucharest

SPAIN

Branch office
Valencia

ITALY

TIEMME RACCORDERIE SPA

GREECE

Branch office
Athens

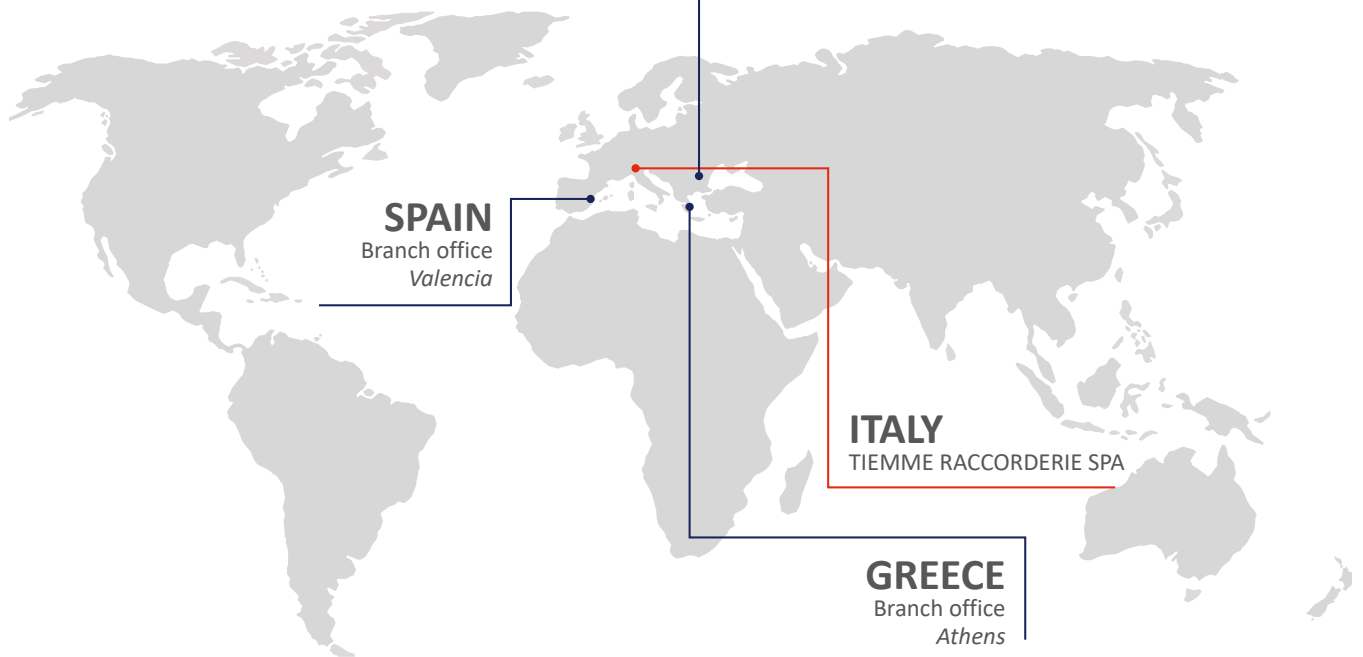



TIEMME
ORIGINAL ITALIAN TRADEMARK

TIEMME, CERTIFIED QUALITY

		ITALY RINA REGISTRO NAVALE ITALIANO		ARGB KVBG	BELGIUM UNIVERSITÉ LIBRE DE BRUXELLES
		ITALY ISTITUTO GIORDANO			UKRAINE ORGANO DI CERTIFICAZIONE CCV "TECKO"
		ITALY ICIM			SLOVAKIA TECHNICKÝ SKÚŠOBNÝ ÚSTAV PIEŠŤANY, Š.P.
		ITALY ICIM CERTIFICATO SECONDO DM N. 174/2004			CZECH REPUBLIC VYZKUMNY ÚSTAV POZEMNICH STAVEB – CERTIFIKACNI SPOLECNOST S.R.O.
		ITALY ISTITUTO NAZIONALE ASSICURAZIONE INFORTUNI SUL LAVORO			CZECH REPUBLIC STROJÍRENSKÝ ZKUŠEBNÍ ÚSTAV
		GERMANY DEUTSCHER VEREIN DES GAS-UND WASSERFACHES			RUSSIA GOST CERTIFICATION
		AUSTRIA ÜA HYGIENE CERTIFICATE			RUSSIA HYGIENE CERTIFICATE
		DENMARK ETA - DANISH BOARD OF EUROPEAN TECHNICAL APPROVAL FOR CONSTRUCTION PRODUCTS			RUSSIA EAC CERTIFICATE
		DENMARK GØDKENDT TIL DRIKKEVAND			POLAND PANSTWOWY ZAKLAD HIGIENY NATIONAL INSTITUTE OF HYGIENE
		DENMARK DTI ENERGY DANSK TEKNOLOGISK INSTITUT			POLAND INSTYTUT TECHNIKI BUDOWLANES
		NORWAY SINTEF CERTIFICATION			HUNGARY ÉPÍTÉSÜGYI MINŐSÉGELLENŐRZŐ INNOVÁCIÓS NONPROFIT KFT.
		SWEDEN RI.SE RESEARCH INSTITUTES OF SWEDEN			UNITED KINGDOM BRITISH GAS TECHNOLOGY
		FINLAND YMPÄRISTÖMINISTERIÖN TYYPPIHYVÄKSYNTAPÄÄTÖS THE FINNISH MINISTRY OF ENVIRONMENT			UNITED KINGDOM WATER REGULATION ADVISORY SCHEME
		SPAIN AENOR			UNITED KINGDOM KUKREG4
		HOLLAND CENTRUM VOOR GASTECHNOLOGIE			FRANCE LABORATOIRE SANTÉ ENVIRONNEMENT HYGIÈNE DE LYON
		HOLLAND CERTIFICATIE EN KEURINGEN			FRANCE CENTRE SCIENTIFIQUE ET TECHNIQUE DU BÂTIMENT
		PORTUGAL CERTIF ASSOCIAÇÃO PARA A CERTIFICAÇÃO			FRANCE CERTIFICATION NF
		ROMANIA AGREMENT TEHNIC ÎN CONSTRUCTII ROMÂNIA			BELARUS STROYTECHNORM
		BULGARIA TÜV RHEINLAND BULGARIA LTD.			SERBIA UNIVERSITY OF NIŠ FACULTY OF MECHANICAL ENGINEERING
		AUSTRALIA IAPMO WATERMARK LICENCE			EUROPE MARCHIO CE DI PRODOTTO
		AUSTRALIA IAPMO OCEANA MARK			VIETNAM TESTING CENTER 3
		AUSTRALIA AGA CERTIFIED PRODUCT			SOUTH AFRICA AENOR

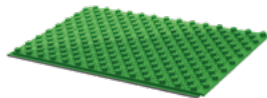

4524GRF

Insulating panel in sintered expanded polystyrene with graphite additives in compliance with UNI EN 13163. It is equipped with reliefs (ashlars) for the locking of the pipe - 50 mm pipe distance - and interlocking grooves on the perimeter for a solid joint between panels.

Insulation thickness complies with UNI EN 1264:2021

PAG. 39

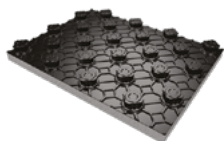

4528PANGRF

Thermoformed panel with ashlars in expanded polystyrene sintered with graphite coupled to a rigid black polystyrene foil with ashlars.

Conforming to EN 13163, it is equipped with reliefs for locking the pipe (50 mm pipe distance) and male/female joints for a solid joint.

The rigid sheet gives the panel greater resistance to wear and tear. The joint male/female perimeter allows the overlapping of the sheets and makes it perfectly compatible with self-levelling liquid screeds.

Insulation thickness complies with UNI EN 1264:2021

PAG. 43



3871PMON

1" distribution monoblock manifold in polyamide with 3/4"x18 outlets (Eurocono) and flowmeters

PAG. 111



3168

Inertial accumulation in stainless steel with function of hydraulic separator in combination with systems with heat pump.

Complete with air vent valve and M/F reduction.

PAG. 140



**5582ISOL - 5582
5583 - 5584ISOL
5584**

Compact multi-zone distribution modules in box

PAG. 162



**5585 - 5585A
5585C - 5585AC**

Biomass circulation and separation hydraulic power units

PAG. 165



**5530W
5530MHCW
5530E3W**

Thermoregulation system Climav 2.0 Building Management Wi-Fi version

PAG. 176

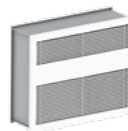

**5600FH1
5600FWZ1**

Dehumidifiers in neutral/cold air, capacity up to 500 m³/h for vertical wall built-in installation, with high efficiency motor

PAG. 198

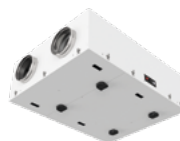

55120

Ventilation unit for tertiary applications, with high efficiency heat recovery unit, horizontal ceiling, or floor installation

PAG. 214



5512V

Ventilation unit for tertiary applications, with high efficiency heat recovery unit, vertical wall installation or floor installation.

PAG. 216



5602GHWZ

CMV dehumidifier with high efficiency recuperator and renewal for ceiling installation

PAG. 220



5502GHWZV

CMV dehumidifier with high efficiency recuperator and renewal for vertical wall or floor installation

PAG. 222



55080

Controlled mechanical ventilation unit with high efficiency heat recovery unit, dehumidification, cooling, and heating section, equipped with additional hydronic battery. Horizontal ceiling installation.

PAG. **226**



5508V

Controlled mechanical ventilation unit with high efficiency heat recovery unit, air treatment with dehumidification, cooling and heating, equipped with additional hydronic battery. Vertical wall or floor installation

PAG. **228**



5603FAN

Ductable fan coil for direct multi-zone management, motors with electronic management in every single served area, in version without regulation with 0-10V control or with direct remote regulation for single zone. Horizontal ceiling installation. Hydraulic connections on the right

PAG. **232**



5608FAN

Ultra-flat fan coil for wall or horizontal ceiling installation with additional condensate collection basin, available with integrated touch control and Modbus or analog and digital 4-speed connection

PAG. **234**

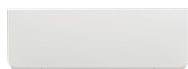

5607FAN

Ultra slim fan coil unit for wall mounting, equipped with double condensate collection basin for reversible installation. Equipped as standard with 3-way valve, available in two control versions, with integrated touch control and Modbus or 0-10V analog and 4-speed digital management

PAG. **236**



5604FAN

Ultra-flat fan coil unit, vertical installation on the wall or in the false ceiling. Classic built-in wall with back-box, front panel or combined with plenum kit and supply grilles, intake, for wall/ceiling installation

PAG. **238**



5509EL

Electric post heating batteries with circular section with integrated flow temperature regulation. Perfect air tightness thanks to the seals on the channel connection sections. Single-phase supplying

PAG. **241**



5509EC

Batteries with hot water operation for heating, with circular section of connection. Terminal battery ideal for post heating in combination with ventilation units for residential installations

PAG. **242**



5509EF

Insulated cold water batteries for heating and cooling, circular connection section.

Terminal battery ideal for post cooling in combination with ventilation units for residential installations

PAG. **243**

INDEX

ART	PAGE	ART	PAGE	ART	PAGE	ART	PAGE	ART	PAGE	ART	PAGE
0200B	23	1681	84	3051ISOL	103	3890PW2	159	4520F	57	5502GHWZV ■	222
0200B	27	1681MINI	75	3051ISOL	108	3890PW5	159	4520F	95	5503BOB	246
0200B	33	1681MINI	84	3144	136	3895KCL	127	4520G	52	5503BOBSL	248
0200B	40	1695TM01	75	3144ISOL	136	3895KHT	128	4520G	56	5503BOC	250
0200B	44	1695TM01	84	3144MAG	136	3895KPF	127	4521	52	5503BOC1	251
0200B	48	1695TM03	75	3165	135	3896CL	124	4521	56	5503BOC1R	251
0200B	52	1695TM03	84	3165ISOL	135	3896CLBYD	124	4521	92	5503COL	249
0200B	56	1828Z	150	3167ISOL	135	3896CLHT	124	4522	95	5503COLP	249
0200B	62	1859	116	3168 ■	140	3896CLHTBYD	124	4522A	95	5503COLT	249
0200B	83	1859	150	3168ISOLIM ■	140	3896PF	122	4524GRF ■	39	5503CUR	246
0200B	92	1863	129	3352	116	3896PFBYD	122	4525	94	5503CUROSL	248
0200B	94	1865	117	3352	129	3896PFHT	122	4527	40	5503CURVSL	248
450XPS	91	1879	96	3670	74	3896PFHTBYD	122	4527	44	5503DIF	251
0635	96	1881	150	3670	79	4501PAN	47	4527	48	5503DIFR	251
0660	33	1889TERMO	116	3670	83	4502SIL	61	4527	62	5503FAS	246
0660	96	1890ISOL	103	3670PSA ■	158	4503	23	4528PANGRF ■	43	5503FIL	250
0660S	33	1890ISOL	108	3868G	120	4503	27	4530	95	5503GIU	246
0660S	96	1890ISOL	117	3868GHTPP2	120	4503	40	4532	41	5503GIUSL	248
1436N	95	1890JISOL	99	3868GHTPP3	120	4503	44	4532	45	5503GPT	250
1436N	126	1939	100	3871KITPMON ■		4503	48	4532	49	5503GRI	250
1436N06	95	1939	104	112		4503	53	4532	53	5503GRI1	251
1436N06	116	1939	110	3871PMON ■	111	4503	57	4532	57	5503GRIAIR	250
1480P	23	1939	112	3871POL	109	4503	63	4532	63	5503OR	246
1480P	27	1940	100	3872POL	113	4503	92	4533	94	5503PLE	250
1480P	33	1940	104	3873	102	4503	94	4535	95	5503RAC	248
1480P	40	1940	108	3873JBYD	99	4505GRF	51	4539	23	5503RCOL	246
1480P	44	1940	114	3873R	103	4505POL	55	4539	27	5503RCOLP	248
1480P	48	1941	117	3873RBYDJ	99	4507	23	4539	33	5503RCOLSL	248
1480P	52	2070	129	3874	115	4507	27	4539	41	5503REG	247
1480P	56	2075KIT01	127	3874ISOL	116	4507	33	4539	45	5503ROVSL	248
1480P	62	2075KIT02	127	3874P	116	4507	40	4539	49	5503SIL	249
1480P	92	2075KIT03	158	3877	106	4507	44	4539	53	5503TAP	246
1480P	94	2095R	150	3877BYD	106	4507	48	4539	57	5503TAPSL	248
1495	95	2120R	110	3877R	107	4507	52	4539	63	5503TCOMPU	246
1552FD	150	2121CP	150	3877RBYD	107	4507	56	4539	74	5503TSLPU	248
1555SET	128	2121CPISOL	117	3878	102	4507	62	4539	79	5503TUB	246
1557SET	128	2121PTISOL	99	3878BYD	102	4507	92	4539	83	5503VAL	251
1557SET	159	2121PTISOL	103	3878RS	118	4507	94	4539	92	5504FIL	209
1602	150	2121PTISOL	108	3879	106	4508	40	4539	94	5504FIL	213
1636N	95	2121PTISOL	110	3879BYD	106	4508	44	4540	40	5504O	206
1636N	126	2134	233	3879R	107	4508	48	4540	44	5504O1	208
1651	79	2138	195	3879RBYD	107	4508	52	4540	48	5504OFIL	207
1652	150	2138	197	3880GPF	158	4508	56	4540	52	5504V	212
1653	79	2138	199	3880GSM	158	4508	63	4540	56	5504VP	213
1657	74	2138	201	3887	127	4511	62	4540	62	5506	203
1657	79	2138	233	3888	128	4513	62	4540	92	5506XL ■	204
1657	84	2371	114	3889	128	4516	92	4540	94	5506XLFIL	205
1665	150	2371ISOL	114	3890BV	127	4517GRF	32	4601	188	5506XLGR	205
1665	159	2990G	116	3890P	159	4517NA	33	4606	188	5507	210
1677	75	2990G	129	3890PU	159	4518GRF	26	4607	189	5507COM	210
1677	84	3049SKIT	129	3890PV	159	4519	22	4612	189	5507COM	214
1681	75	3051ISOL	99	3890PW2	128	4520F	53	4745MANOP	158	5507COM	216

■ New product

INDEX

ART	PAGE	ART	PAGE	ART	PAGE	ART	PAGE
5507COM ■	244	5513	215	5540G4M6	146	5602FIL3	221
5507COP	211	5513	217	5540G4M8	146	5602FIL3	223
5507FIL	211	5514	234	5540G5M6	146	5602GHWZ ■	220
5507T	211	5514	236	5540G5M10	147	5603FAN ■	232
5508COM	204	5514	238	5540G6M8	147	5603FIL	233
5508COM	206	5514 ■	244	5540G6M12	147	5603PL	233
5508COM	208	5530E	184	5540G7M8	147	5604A	239
5508COM	232	5530E1	185	5540G7M14	148	5604FAN ■	238
5508COM	212	5530E2	185	5540X	141	5604GRI	239
5508COM	226	5530E3W ■	186	5540X	141	5604P	239
5508COM	228	5530I9	185	5570	74	5604PL	239
5508COM ■	244	5530I10	185	5570	79	5604PL01	239
5508FIL	227	5530M1	178	5570	83	5604PL02	239
5508FIL	229	5530M2COM	183	5581	75	5605	235
5508O ■	226	5530M5	183	5581	84	5606	235
5508PIE	235	5530M6	183	5581C	75	5606	239
5508ST	235	5530M8	177	5581C	84	5607FAN ■	236
5508V ■	228	5530MHCW ■	176	5581T	75	5608BAC	235
5509EC	207	5530P	184	5581T	84	5608FAN ■	234
5509EC	209	5530S1	180	5582 ■	162	7166	138
5509EC	213	5530S2	181	5582ISOL ■	162	7167	138
5509EC	215	5530S3	181	5583 ■	162	9561KIT01	127
5509EC	217	5530S4	179	5584 ■	163	9561KIT02	158
5509EC	221	5530S5	179	5584ISOL ■	163	9562SERV	158
5509EC	223	5530S6	180	5585 ■	165	9567	126
5509EC	227	5530S7	178	5585A ■	165	9567KIT	116
5509EC	229	5530S10	182	5585AC ■	165	9568	126
5509EC ■	242	5530S11	182	5585C ■	165	9573	188
5509EF	207	5530V	244	5600FH	196	9574	188
5509EF	209	5530V	177	5600FH1 ■	198	9589	190
5509EF	213	5530W ■	244	5600FHDWZ	200	9590	190
5509EF	215	5530W ■	176	5600FHWZ	196	9591	190
5509EF	217	5534G	156	5600FHWZ1 ■	198	9592	190
5509EF	221	5534G3P	157	5600GH	194	9683CU	194
5509EF	223	5535DIFF	158	5600GHWZ	194	9683CU	196
5509EF	227	5535G	151	5601A	197	9683CU	198
5509EF	229	5535G3P	153	5601A1	199	9683CU	200
5509EF ■	243	5535GPF	152	5601FFH	197	9683CU	244
5509EL	207	5536G	154	5601FFH	199	H9708	129
5509EL	209	5536GS	155	5601FFH	201	H9709	129
5509EL	213	5537KIT	158	5601FGH	195	RG	78
5509EL	215	5538G2M3	144	5601P	197	RGN	79
5509EL	217	5538G2M4	144	5601P1	199	RNU	70
5509EL	221	5538G3M4	144	5601PGH	195	RU50	70
5509EL	223	5538G3M6	144	5601PGHM	221	SK600PL	82
5509EL	227	5538G4M6	145	5601PGHM	223	SK600PLN	83
5509EL	229	5538G4M8	145	5601PGHM	195		
5509EL ■	241	5538X	141	5602CON	220		
5512FIL	215	5539X	141	5602CON	222		
5512O ■	214	5540G2M4	145	5602CON	244		
5512V ■	216	5540G3M4	145	5602FIL	221		
5512VFIL	217	5540G3M6	146	5602FIL	223		

■ New product

A	Radiant conditioning	
	Core principles of radiant conditionin	2
	Excellent comfort	3
	Moving towards sustainable decisions	4
B	Regulations for radiant systems	5
C	Energy efficiency	6
D	Know-how and partnerships	7
E	EFESTO	8
F	10 years warranty	9
G	The technical team	10
H	Tiemme Technical Service	11
I	Tiemme LAB	12
L	Tiemme BIM	13

Tiemme radiant solutions provide an excellent, optimized-cost indoor climate ideal for both living and working.

Our energy-efficient solutions can be combined with renewable energy sources, contributing to reduce energy consumptions and carbon emissions, ensuring the best conditions for an ideal indoor climate.

Tiemme offers water-based floor, wall, and ceiling heating and cooling systems

Due to their low-temperature functioning, radiant systems are the most cost-effective way in terms of energy to heat indoor environments in a building.

Low temperatures guarantee the highest efficiency of heating sources, preferably renewable sources like geothermics or heat pumps. This results in low energy consumption and decreased carbon emissions.

Furthermore, radiant heating provides the highest comfort and can also be used as a cooling system. Its silent installation results in maximum freedom in terms of architecture and design.

There is no plausible reason to choose a different indoor heating or cooling solution.

Radiant heating/cooling systems rely on a radiation principle, resulting as the most innovative, adaptive, safe, and effective way to provide comfort in any type of building.

Using floor as a heating/cooling element enables the use of a low-temperature fluid, thus providing maximum comfort, due to radiation, and saving energy and money.

How it works

Floor heating systems generate circulating low-temperature water (35÷40°C) channeled in closed circuits of thermoplastic piping, buried in the screed underneath flooring.

Circuits create a large radiant surface, which heats the room upwards by layering the heat according to an ideal temperature curve: warmer feet, cooler head.

This radiant heating system distributes heat in a way opposite than radiators or convectors that warm the environment by creating a high layer of heat, resulting in a significant loss of energy, money, and comfort.



Comfort is a condition of psychological and physical well-being resulting from the individual perception of temperature, humidity, noise and brightness of an indoor environment.

A radiant system certainly concerns “thermo-hygrometric” comfort, an aspect highly impacted by the type of heating/cooling system installed.

Due to the heating transmission occurring via radiation, a radiant system infuses people with the same sensation of well-being experienced when kissed by the winter sun.

Although this happens at a low temperature, the sun transfer its warmth to our body by creating a pleasant feeling of well-being. Laboratory tests have shown that among available heating/cooling systems, radiant heating with proper size and installation represents the closest ideal curve, where layered temperature concentrates heat towards the floor, gradually cooling the environment upwards, inverting the direction if the system includes radiators or fan coil units.



Paris agreements' objectives (COP 21), which have been ratified by most Governments in the world, and the energy certification of building required by the European Directive 2002/91/EC are factors pressing for sustainable decisions to be taken on systems installed in buildings.

It is worth to point out that 40% of the entire European energy consumption is ascribable to buildings. Savings are our major energy source and a better energy efficiency cannot but be a shared goal..

HIGH ENERGY EFFICIENCY IMPLIES SAVING MONEY

he system operates mostly by transferring the heat via radiation and only partially via convection, thus resulting highly efficient even in environments with a temperature of 35-40°C.

The small thermal gradient between the temperature of the radiant system and room temperature reduces dispersion and improves the system efficiency.

Low temperatures of the fluid circulating in the system significantly reduce the energy required, saving an average of 20% energy per year in home systems, and up to 40-50% in high-ceiling buildings like warehouses, places of worship,

gyms, etc., subsequently granting a significant saving of money.

RADIANT CONDITIONING: A VALUABLE AND AWARE CHOICE

In the previous paragraph we highlighted that a radiant system secures a significant saving in terms of energy and, as a consequence, money. However, does the reduction of energy consumptions contributes to preserve our planet? Saving energy is not a mere economic benefit but must become an informed decision for our future.



The UNI EN 1264:2021 standard is the technical regulation that defines all the elements that make up a floor, wall and ceiling system. It consists of 5 parts and is a product standard, and within it the calculation methods for the design of radiant systems are indicated.

In July 2021, the update revision UNI EN 1264:2021 was published, in part 4 of the standard titled 'installation' has been integrated more than in the previous version. Insulation, joints and compliance with installation conditions are the main new features covered.

INSULATING LAYERS

The standard pays particular attention to the thermal resistance of the insulating layers placed between the system and adjacent rooms or to the outside. An 'insulating layer' is considered to be that which makes up the system and is placed immediately under the pipe; in the case of several layers of insulating material, the coupling between two or more materials will acquire this definition.

Table 1, concerning compliance with the thermal resistance of horizontal dispersing structures, has not been changed from the previous version, however, some important details for calculating the thermal resistance of systems used in building renovations versus new construction have been revised.

Thermal resistance that shall be considered are reported in the diagram and in the relevant table.

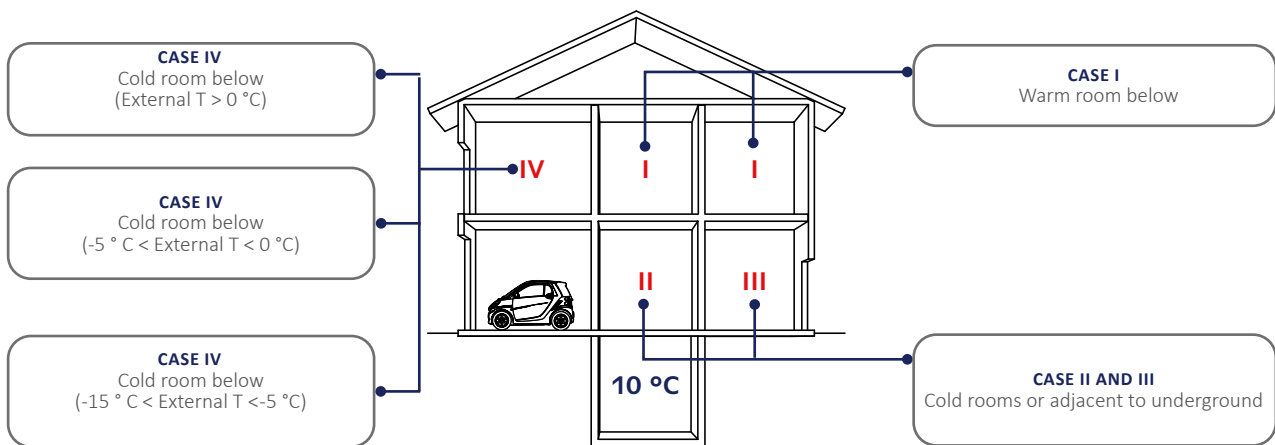

	I	II e III	IV		
	Heated room below	Non-heated room below	External temperature > 0 °C	External temperature -5 / 0 °C	External temperature -15 / -5 °C
Internal Temperature iT (°C)	20	20	20	20	20
Thermal resistance Rλ (m²K/W)	0,75	1,25	1,25	1,50	2,00

The new calculation approach makes the following distinction:

- **Radiant systems in new buildings**, the thermal resistance of the insulation Rλ.Ins must be determined considering the insulation layer(s) underneath the pipe;
- **Radiant systems in buildings subject to building renovation**, the thermal resistance of the insulation Rλ.Ins can be determined taking into account the actual thermal resistance of the building structure, including the insulation layer(s) underneath the pipe.

RENOVATION

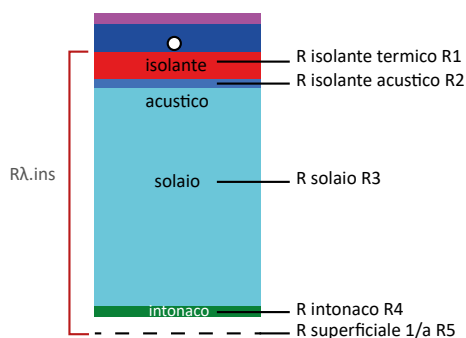

The thermal resistance is obtained by adding up all thermal resistance of the layers UNDER THE PIPE.

$$R_{\lambda,ins} = R_1 + R_2 + R_3 + R_4 + R_5 = m^2K/W$$

NEW BUILDING

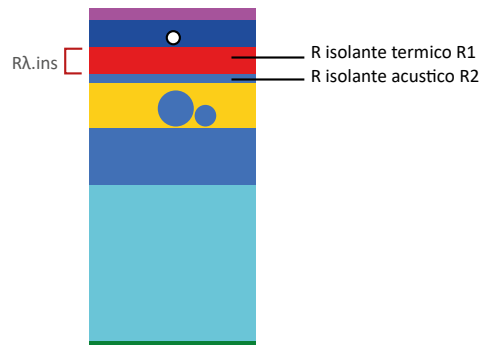

The thermal resistance is obtained by adding up all thermal resistance of the INSULATING ELEMENTS ONLY present UNDER THE PIPE.

$$R_{\lambda,ins} = R_1 + R_2 = m^2K/W$$

QUALITY LABEL

Nowadays, radiant systems are available on the market among the most efficient systems in terms of flexibility and comfort provided, granting a significant energy saving. These systems are tailored upon the target building and are governed by a wide range of settings.

In this regard, the energy efficiency classification of UNI/TR 11619:2016 and the RSEE index determine the standards to maximize comfort and reduce the consumptions to a minimum.

AAA classification	> 0.98		- 2.172 kWh/year
AA classification	0.94 - 0.98		- 2.064 kWh/year
A classification	0.92 - 0.94		- 1.893 kWh/year
B classification	0.90 - 0.92		- 1.774 kWh/year
C classification	0.88 - 0.90		- 1.648 kWh/year
D classification	< 0.88		- 1.517 kWh/year

Zone control:
a single thermostat installed in the central area of the house.

- Single thermostat
- ON/OFF controller
- Balanced
- IEE > 0.23 circulating pump

Floor sunk panels	0.883	C
Ceiling panels sunk	0.865	D
Wall panels	0.865	D

EFFICIENZA ENERGETICA SISTEMA RADIANTE
www.q-rad.it

Single room control:
a sensor in each room, installed in the living room, the kitchen, and bedrooms.

- Sensor in each room
- PI or PID controller
- Not balanced
- IEE > 0.23 circulating pump

Floor sunk panels	0.922	A
Ceiling panels sunk	0.904	B
Wall panels	0.904	B

EFFICIENZA ENERGETICA SISTEMA RADIANTE
www.q-rad.it

Zone control + climate control:
a thermostat installed in the central area of the house connected to an external temperature sensor.

- Single thermostat
- Prop. range P controller 1°C
- Balanced
- IEE ≤ 0.23 circulating pump

Floor sunk panels	0.950	AA
Ceiling sunk panels	0.931	A
Wall panels	0.931	A

EFFICIENZA ENERGETICA SISTEMA RADIANTE
www.q-rad.it

Single room control + climate control:
a sensor in each room, installed in the living room, the kitchen, and bedrooms, connected to an external temperature sensor.

- Sensor in each room+climate
- PI or PID controller
- Balanced
- IEE ≤ 0.23 circulating pump

Floor sunk panels	0.980	AAA
Ceiling sunk panels	0.960	AA
Wall panels	0.960	AA

EFFICIENZA ENERGETICA SISTEMA RADIANTE
www.q-rad.it

TIEMME PARTNERS WITH CASA CLIMA

The CasaClima Agency is an instrumental body of the Autonomous Province of Bolzano/Bozen. It was established to issue the mandatory energy certification for South Tyrol buildings and has served as an agency for energetic and climate matters since 2014.

CasaClima Agency has worked for many years in partnership with leading companies in the quality building sector, in order to promote citizens' responsibility and awareness on saving energy, sustainability, and climate change.

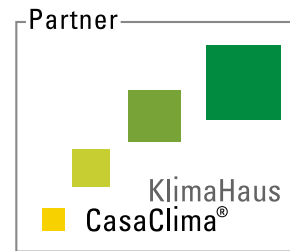

TIEMME IS ASSOCIATED WITH QRAD

Q-Rad (Consortium of the Italian Producers of High Quality Radiant Systems) includes some of the most important Italian companies in the sector of heating and cooling systems. The consortium aims to promote, support, and develop awareness on the benefits resulting from radiant systems as a means to increase energy saving and house comfort, applied both to houses and industrial/service-providing buildings.

Consorzio Italiano
Produttori Sistemi
Radianti di Qualità



TIEMME IS KIWA CERTIFIED

Kiwa Group in Italy verifies the quality of products and processes, and makes personal and environmental performance more transparent. In order to do so, it supports companies, organizations, and governments to meet necessary certification requirements and provides them with testing, inspection, and training.

Established in the Netherlands in 1948 as a certifying institute for systems operating with drinking water, Kiwa played a critical role in rebuilding Dutch water network after the Second World War. Since then, it has supervised the quality of public water. Over the years, its activities have extended beyond the "water market" to include any type of market, from constructions to the energy sector, from quality systems to food and drink, medical, environmental, renewable energy, and many other sectors.

Nowadays, Kiwa is a new independent, highly experienced organism providing testing, inspection, and certification (TIC), with a global network and working closely with its clients as a "Partner for Progress".



UNI EN ISO 9001:2015

Efesto is software created by Tiemme and designed for all those professionals in need of IT support, aiming to simplify the design of radiant systems, whether they are floor, ceiling or wall installed.

It is extremely easy to use, thus allowing to navigate the wide range of Tiemme solutions and quickly identify the products you need to develop your projects.

The following aspects constitute Efesto's main strengths:

- Fast learning in the design phase;
- Automatic creation of comprehensive lists of materials;
- Possibility to import and export DWG® drawings;
- Possibility to display projects both with top view and vertical section;
- Automatic drawing of coils for radiant floor systems;
- Design of heating and cooling systems.

With Efesto you can develop any project involving radiant systems. In details:

- Apartments, villas, apartment blocks, or other buildings for **residential** purposes;
- Warehouses or other buildings for **industrial** purposes;
- Schools, places of worship, sport centers, or other buildings for **public** purposes;
- Offices, stores or other buildings providing **services**.

Efesto is simple and flexible software and a necessary product for those who want their design process to go one step further.





Tiemme radiant systems offer a comprehensive range of applications that will definitely meet all of your comfort needs in any house. Each system results from a continuous research of the best technology and materials, in order to provide clients with state of the art solutions in terms of both thermal and/or acoustic insulation and eco-sustainability. However, a system's reliability is as important as its performance. Tiemme is aware that a radiant system should not raise concerns. That is why reliability is one of its core values and entails a 10 year warranty on Tiemme systems. We are honored to introduce you to **zero10 warranty**.





GARANZIA 10 ANNI

SISTEMI DI RISCALDAMENTO/RAFFRESCAMENTO RADIANTE

Tiemme Raccorderie S.p.A. garantisce per 10 anni i tubi, Cobra-pex Oxistop, Al-Cobrapex e i relativi accessori in ottone Tiemme utilizzati all'interno dell'impianto radiante. La garanzia viene concessa con l'emissione di un Datto certificato viene emesso esclusivamente a seguito specifica richiesta dell'installatore.

a) Committente: _____

b) Progettista responsabile: _____
Indirizzo _____

c) Progetto di riferimento: _____

d) Luogo di installazione: _____

e) Tipo di sistema: _____

f) Tipo di tubazione: _____
 CobraPex Oxistop Al-CobraPex

g) Accessori in ottone, acciaio, poliammide: _____

h) Impresa di installazione: _____
Indirizzo _____

i) Rivenditore _____



j) Data fine installazione: _____

m) Data di collaudo/avviamento impianto: _____

Dichiaro sotto la mia personale responsabilità che il materiale è stato installato e sottoposto al collaudo rispettando le indicazioni tecniche pubblicate sui cataloghi tecnici del produttore, e/o dalla norme di riferimento e/o del progetto.

Timbro e firma dell'installatore: _____
Data: _____

La garanzia è valida unicamente se compilata in ogni sua parte e trasmessa alla TIEMME RACCORDERIE S.p.A. entro 30 giorni dalla data di collaudo del sistema/avviamento impianto.

0270_RAD_803

1/3



ORIGINAL ITALIAN TRADEMARK

Tiemme strongly believes that the a support service for the design phase is critical for installers and professionals. The company also includes a department solely devoted to the design and quote of radiant systems, metering systems, and central heating systems. Highly qualified and experienced operators in the field of design listen understand client requirements and guide them to choose the best solution that fits their needs. The system division guarantees adequate support even on any needs that might arise on the site, from controlling the correct functioning to initial system configuration and operation phases. The team organizes work so as to reduce response time to a minimum. The services is offered for free but it is greatly valuable and develops about 5000 projects per year.

Tiemme relies on a long list of specialists working with a wide range of corporate instruments to provide tailored counseling in any system phase.



Tiemme Technical Service (TTS), is a service guaranteed by Tiemme and provided thanks to many professional partners collaborating with us to create a competent and available support network.

TTS can satisfy any request concerning Tiemme's sector of operations, from single product installation to operation, testing, maintenance, and repairs of simple and complex systems.

For further information on this service, write to the following e-mail address: sistemi@tiemme.com.

TIEMME, EXCLUSIVE CUSTOMER CARE

You can find precious information for your job or activity, in "MyTiemme" reserved area of our website. Tiemme has made its catalogues available online for you to read or download at any time. You will also find our technical catalogues, brochures, specifications, certifications, declarations of performance and compliance. You can access them from the page including the details of your desired item.

The platform is supported by any device.

www.tiemme.com

DID NOT FIND WHAT YOU WERE LOOKING FOR?

- Customer service: customerservice@tiemme.com
- After-sales service: service@tiemme.com
- Get a quote: sistemi@tiemme.com
- Tiemme S.p.A: info@tiemme.com
- T +39 030 2142211 - F +39 030 2142206





Tiemme's flagship is the **Tiemme LAB** training centre, an innovation hub inaugurated in 2012 that aims to allow professionals in the sector and beyond to discover the various Tiemme solutions and keep up to date with new products and technologies. Training courses are regularly organised and created to enrich the professionalism of plumbing distributors, installation technicians, designers, thermal technicians, architects, and students, who can take part in top-level courses divided by type of application or design techniques.



WHAT IS BIM?

BIM stands for “Building Information Modeling”, a digital process that takes place over the entire life span of the building (from design to maintenance). It allows to interact with other agents involved in the production chain through a smart digital model, entering and updating our data, reporting our changes or detecting somebody else’s. The purpose is to create a more fluid communication process, avoiding data losses and with real-time updates.

TIEMME AND BIM

Tiemme always keeps up with new trends and decided to include its product in the BIM world, so as to provide designers with the best support for their everyday design operations.

Hence, the company created an internal team with qualified personnel checking the quality and functioning of the products developed. If needed, our team can support the designer at any time, starting from the decisional phase, where they provide help to select the best product depending on client requirements, comply with sector-bound regulations, and identify the best approach, right through to actual interventions to solve any issue. BIM TIEMME models imply the use of verified products that match the actual object, thus granting access to the correct size, materials, certifications, and system sizing, in a single solution, without wasting any time looking for information.

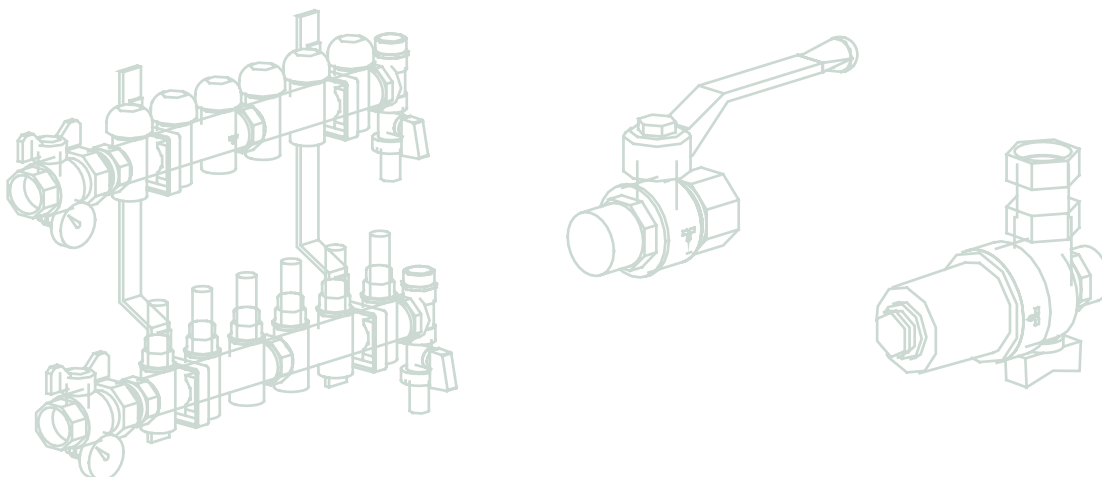

01 FLOOR RADIANT SYSTEMS

01A	Why the Tiemme floor radiant system?	16
01B	"GRAPHITE" systems: why use radiant panels with graphite additives?	17
01C	Low thickness systems	
	Low thickness systems - introduction	18
	Derogation from minimum interior height residential spaces	19
	NZEB buildings	19
	TIEMME SLIM	20
	LOW BLACK	24
	DRY	28
01D	Systems for residential/tertiary use	
	Systems for residential/tertiary use - introduction	34
	NEW CLASSIC GRAPHITE	36
	TECHNO GRAPHITE CAM	40
	BASIC	44
	CLIP GRAPHITE	48
	CLIP SUPER	52
01E	Sound-absorbing systems	
	Sound-absorbing systems - introduction	56
	Sound insulation: laws and regulations	57
	SILENTO	58

01_A WHY THE TIEMME FLOOR RADIANT SYSTEM?

IMPROVED DIFFUSION OF HEAT

The radiators diffuse the heat by convection pushing the hot air upwards and consequently the cold air downwards. In the case of floor heating, diffusion occurs by radiation, a phenomenon that guarantees a constant temperature throughout the environment.

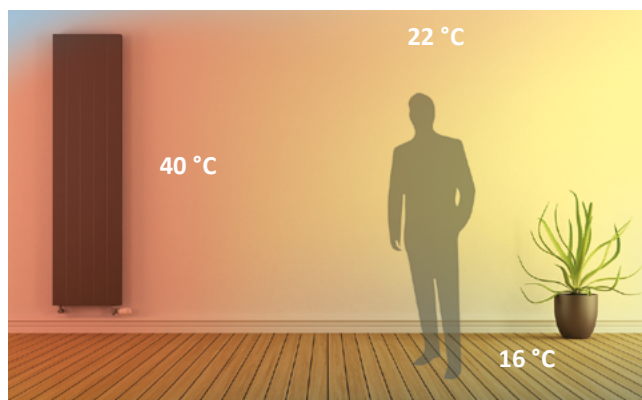

Radiator heating

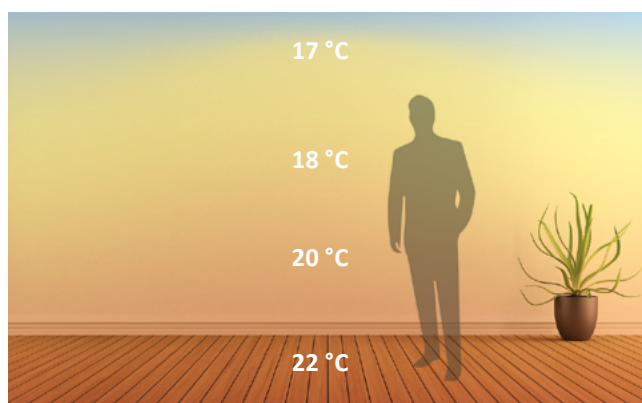

Floor heating

COMPATIBILITY WITH RENEWABLE ENERGY

A radiator system requires gas or diesel heating that can bring the water to a temperature between 70 and 80 °C. The floor system works at temperatures much lower, between 35 and 40 °C, and therefore offers maximum compatibility with more environmentally friendly energy sources such as pellet boilers, heat pumps and solar energy plants.

REDUCTION OF DUST, MITES, AND MOULDS

The presence of radiators produces dust that then spread annoyingly in the environment as a result of convection. In case of floor heating this problem is greatly reduced as well as the presence of mites and mould.

FULL FREEDOM IN THE ORGANISATION OF INTERIORS

The radiators limit the internal space making unusable the walls on which they are placed. The floor heating system allows to recover a lot of space making the walls entirely usable.

FULL FREEDOM IN CHOOSING THE FLOOR

The radiant system is compatible with any type of flooring: from laminates to tiles, from carpet to terracotta. The only caution concerns the wood for which you will have to pay more attention in the choice of a stable and small parquet.



01 B "GRAPHITE" SYSTEMS: WHY USE RADIANT PANELS WITH GRAPHITE ADDITIVES?

Graphite is one of the allotropic forms of **carbon**.

It has a crystalline structure with carbon atoms arranged on parallel layers and consisting of a lattice of regular hexagons with a carbon atom at the vertices. Thanks to this particular honeycomb molecular structure, **graphite particles absorb and reflect the heat collected and minimise heat transmission by radiation.**

It is precisely to exploit this property that Tiemme has chosen to offer graphite insulating panels characterized by a greater insulating power:

- **LOW BLACK**
- **DRY**
- **NEW CLASSIC GRAPHITE**
- **TECHNO GRAPHITE CAM**
- **CLIP GRAPHITE**

The addition of additives makes it possible to lower the thermal conductivity coefficient to a value of 0.030 W/mk, making it possible to comply with the UNI EN 1264 standard with a lower thickness of the insulation layer of the panel.

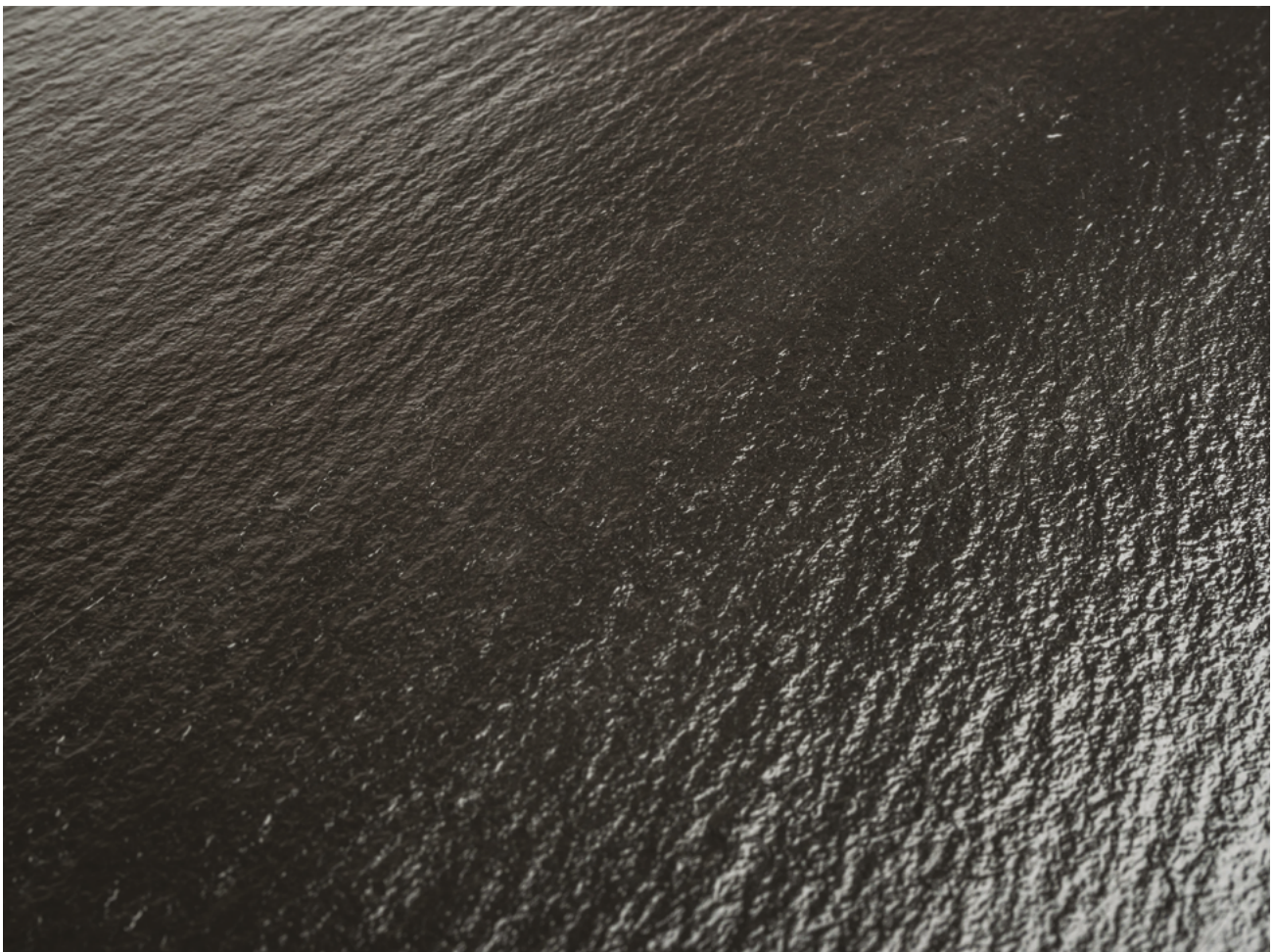

The renovation is an important opportunity to improve the energy performance of your home, to gain in efficiency and thus reduce the consumption of plant management.

Efficient renovation involves replacing the heat generator and the old radiator heating system with more innovative and performing solutions.

Under the current regulatory regime, this type of action is encouraged by tax advantages in favour of the taxpayer. From the structural point of view, interventions such as: structural consolidation, humidity inside the walls, the replacement of fixtures as well as the limitation of overloads on the floors and seismic adjustment should be considered.

The wide range of radiant solutions proposed by TIEMME includes floor or ceiling heating and cooling systems developed ad hoc to meet all the specific needs of the buildings under renovation.

The objective remains always that of a system perfectly integrated in the environment, today more than yesterday..



**TIEMME FOR
THE RENOVATION
AND ENERGY UPGRADING**

TIEMME'S SOLUTION

TIEMME SLIM



LOW BLACK



DRY

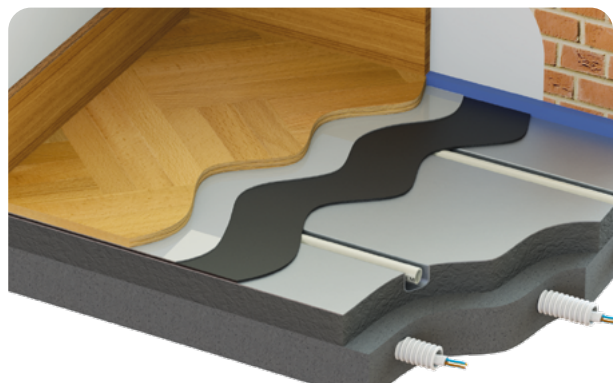

Buildings designed with high quality standards of thermal insulation, in line with European directives that require the construction of "almost zero energy" buildings by 2020, find in the radiant system on the wall, ceiling or floor (low thermal inertia) the ideal solution for winter and summer air conditioning. A home that meets today's energy standards is characterized by:

- reduced energy requirements for summer and winter air conditioning;
- a discontinuous and time-limited power demand.

Radiant systems with low thickness screeds are the best solution to adopt, as they are characterized by reduced thermal inertia and reduced commissioning times.



The regulatory framework is very clear and consequently the world of renovations and upgrading proceeds towards low-consumption and high-performance buildings, that's why TIEMME has provided a wide range of floor and ceiling heating and cooling systems specifically to meet the specific needs of new and renovated buildings, Tiemme's technical team is ready to meet every request by proposing the right system according to the characteristics of the project.

THE ASSESSMENT OF INERTIA IN RADIANT SYSTEMS

In physics, particularly in mechanics, the inertia of a body is the property that determines the resistance to changes in the state of motion, and is qualified by inertial mass.

Applying this concept to radiant systems is complex because many boundary conditions affect their performance.

The factors that affect the inertia of the system are:

- The inertial temperature
- The temperature of the room to be air-conditioned
- The location of the system (interfloor or external contact)

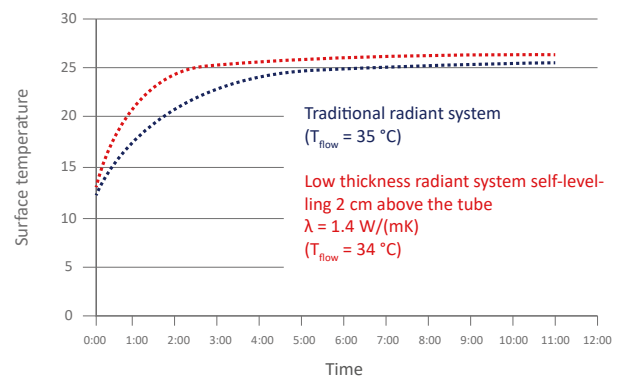

A fast and precise methodology for the evaluation of inertia is the realization of dynamic simulations to finite elements on plant sections. An example of the results obtainable is shown in the figure above where the surface temperatures of two radiant systems are represented as a function of time. For the low thickness system (in red in the graph) the time it takes to reach the desired surface temperature is less than 30 minutes. For the traditional system consisting of insulation and cement screed the time it takes to reach the surface temperature is greater. This aspect must be considered in the design of the system regulation to ensure the desired temperatures within 24 hours. The concept of thermal inertia is also important during plant shutdown: a low inertia system will take less time to cool than a traditional system. Radiant systems with low-thickness screeds, and therefore with low thermal inertia, allow an extremely effective environmental regulation in perfect harmony with the new low-consumption building.

TIEMME SLIM is the innovative Tiemme system created to meet the demand for low thermal inertia and low thickness radiant systems. Designed to meet the needs of the plant in case of renovation, it allows, thanks to the reduced thickness and the possibility to glue it to the existing flooring, to realize the system without resorting to demolition.

It can be combined with pipes of 16x2mm and 17x2mm diameter ensures excellent flow rates both in winter and summer with low pressure losses and consequent optimization of the circulation pump. The ashlar, optimized to ensure the perfect contact of the pipe with the screed, increases the performance of the system and allows the laying even diagonally at 45 o'clock without the use of fixing clips. The preformed foil in thermoformed polystyrene has a high resistance to trampling optimizing the laying on site. Available in the version with insulation.

TIEMME SLIM SELF- ADHESIVE (PANEL COD. 450 0641)

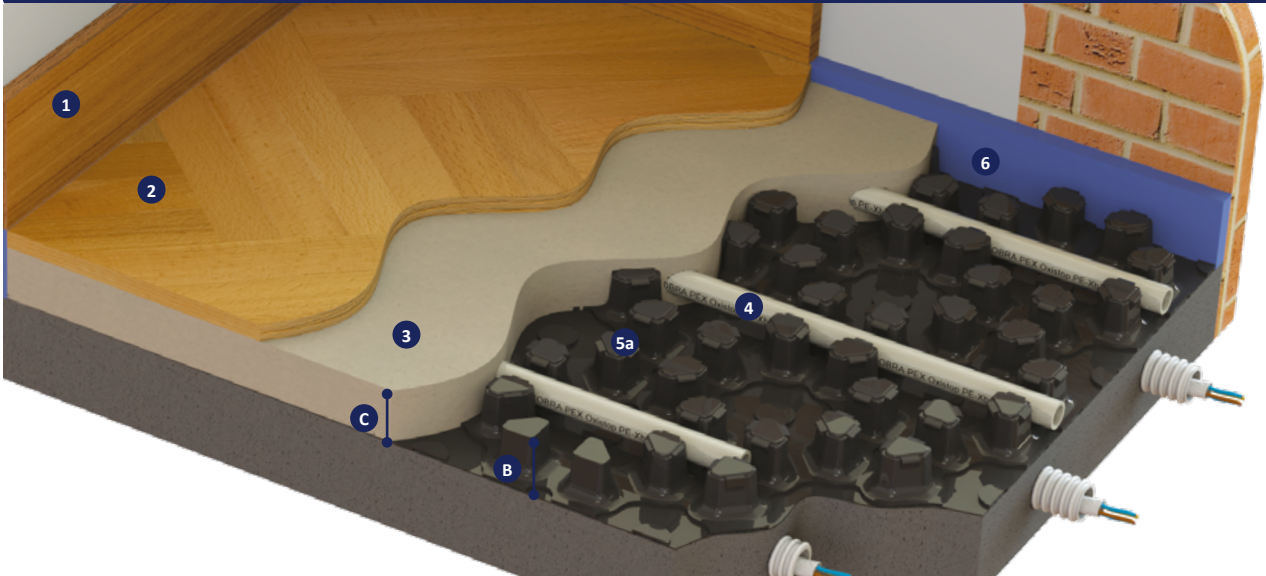

TIEMME SLIM WITH INSULATION (PANEL COD. 450 0642)



- | | |
|-----------------------------|---------------|
| 1. Skirting | - |
| 2. Coating | - |
| 3. Low floor screed | - |
| 4. Pipe | art. 0200B |
| 5. (5a) Self-adhesive panel | cod. 450 0641 |
| (5b) Insulation panel | cod. 450 0642 |
| 6. Perimeter strip | art. 4507 |
| 7. PE sheet | art. 4503 |

Code	Dimensions (mm)		
	A	B	C
450 0641	-	19	23,6 ÷ 38,6 (*)
450 0642	5	23,6	33,6 ÷ 43,6 (*)

(*) Depending on the screed used.
See section "Guide to screed making" on the next page.



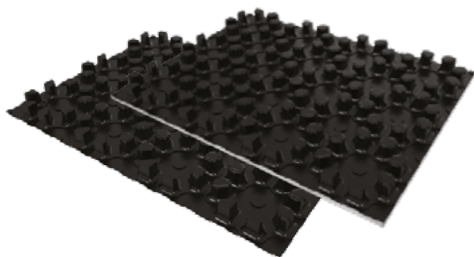

4519

Thermoformed panel without thermal insulation with self-adhesive bottom or with 5mm of EPS 200 insulation, with embossed ashlars for locking the pipe even at 45°. Specific for renovations.

Code	Insulation thickness (mm)	Total thickness (mm)	Price €/m ²	Packaging (m ²)	Packaging (no. panels)
450 0641	-	19		17,92/215,04	16
450 0642	5	23,6		22,40/134,40	20

TECHNICAL CHARACTERISTICS

	Codes	
	450 0641	450 0642
Panel dimensions (mm)	1400 x 800 Self-adhesive base	1400 x 800
Insulation thickness (mm)	-	5
Ashlars thickness (mm)	18	18
Total panel thickness (mm)	19	23,6
Pipes thickness (mm)	16 - 17	16 - 17
Minimum pipe distance (mm)	50 (90° laying) - 71 (45° laying)	50 (90° laying) - 71 (45° laying)
Thermal resistance on average effective thickness R _{λ,ins} (m ² K/W)	-	0,15
Thickness of thermo-perforated foil in PS (mm)	1	0,6
Declared thermal conductivity (W/mk)	-	0,034
Fire reaction class EN 13501-1 (Euroclass)	E	E
Panels per package (n)	16	20
Panel area per package (m ²)	17,92	22,40

GUIDE TO SCREED MAKING

The optimal performance of the Tiemme SLIM radiant system is achieved when the screed, an integral part of the radiant section, completely embraces the pipe, ensuring optimal heat transfer by conduction. A good screed must be able to ensure the levelling of the surfaces, evenly distribute the loads, be an excellent foundation for flooring and, above all, ensure a perfect reception for floor heating systems. Tiemme recommends in combination with the innovative Tiemme SLIM system the KNAUF mixes: NE 499 for screeds up to 5/10 mm above the ashlar, NE 425 for screeds up to 20 mm above the ashlar. NOTE: In the case of using a self-levelling screed, follow the instructions of the supplier.

Knauf Screed		Codes	
		450 0641	450 0642
NE 499 - Thickness 5/10 mm λ = 1,3 W/(mk)	Panel thickness	19 mm	23,6 mm
	Panel thickness + Screed	24 / 29 mm	33,6 mm
NE 425 - Thickness 20 mm λ = 1,4 W/(mk)	Panel thickness	19 mm	23,6 mm
	Panel thickness + Screed	39 mm	43,6 mm



0200B

High density COBRAPEX cross-linked polyethylene pipe with EVOH oxygen barrier.

TECHNICAL CHARACTERISTICS

- Maximum operating temperature: 95 °C
- Thermal conductivity: 0,38 W/mk
- Complies with EN ISO 15875-2
- Anti-oxygen barrier in EVOH compliant with DIN 4726
- Composition: PE-Xb

Code	Type	Price €/m	Unit/Box (m)
020 0005	16 x 2,0		120/3240
020 0018	16 x 2,0		200/3600
020 0003	16 x 2,0		300/3600
020 0001	16 x 2,0		600/3000
020 0008	17 x 2,0		120/3240
020 0071	17 x 2,0		200/3200
020 0006	17 x 2,0		300/2700
020 0002	17 x 2,0		600/3000

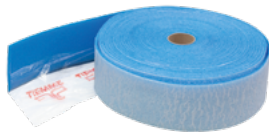

4507

Perimeter strip in expanded PE with adhesive back and PE sheet to contain mortar.

i With pre-cut H = 100 mm

Code	Type	Price €/m	Unit/Box (m)
450 0443	H 150 x 5 mm		50/250
450 0007	H 150 x 8 mm		25/125



1480P

Plastic 90-fold elbow for the protection and support of the COBRAPEX pipe near the connection to the distribution manifold.

Code	Type	Price €	Unit/Box
034 0077	Pipe Ø 16 - 18		25/500

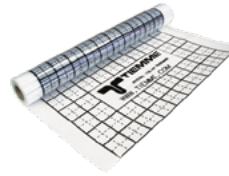

4503

PE sheet with insulation function and moisture barrier.

TECHNICAL CHARACTERISTICS

- Width: 1,2 m
- Length: 100 m
- Thickness: 0,15 mm

Code	Type	Price €/m ²	Unit/Box (m ²)
450 0025	-		120/120



4539

Corrosion protection of metal parts with universal fungal bactericide for heating and cooling systems.

TECHNICAL CHARACTERISTICS

- Dosage: 1 l of additive x 100 l of circulating water

Code	Type	Price €	Unit/Box
450 0486	1 l		1/12



FROM TIEMME'S RADIANT TECHNOLOGY AND KNAUF SCREED KNOW HOW

THE INNOVATIVE TIEMME SLIM SYSTEM IS BORN.

System certified to concentrated vertical loads Q_k by the laboratory Elletipi S.r.l. with NE 499 and NE 425 Knauf self-leveling compounds:

- TIEMME SLIM self-adhesive panel combined with Knauf NE 499 self-leveling compound from 5 mm thickness above the pipe
- TIEMME SLIM panel with EPS 200 insulation combined with Knauf NE 425 self-leveling compound from 10 mm thickness above the pipe



ADHESIVE FILM

No unwanted displacement and demolitions



THERMOFORMED ASHLAR

Maximum ease of installation



LOW THERMAL INERTIA



LOW THICKNESS

Complete in just 24 mm

RENOVATING WILL NO LONGER BE A PROBLEM.

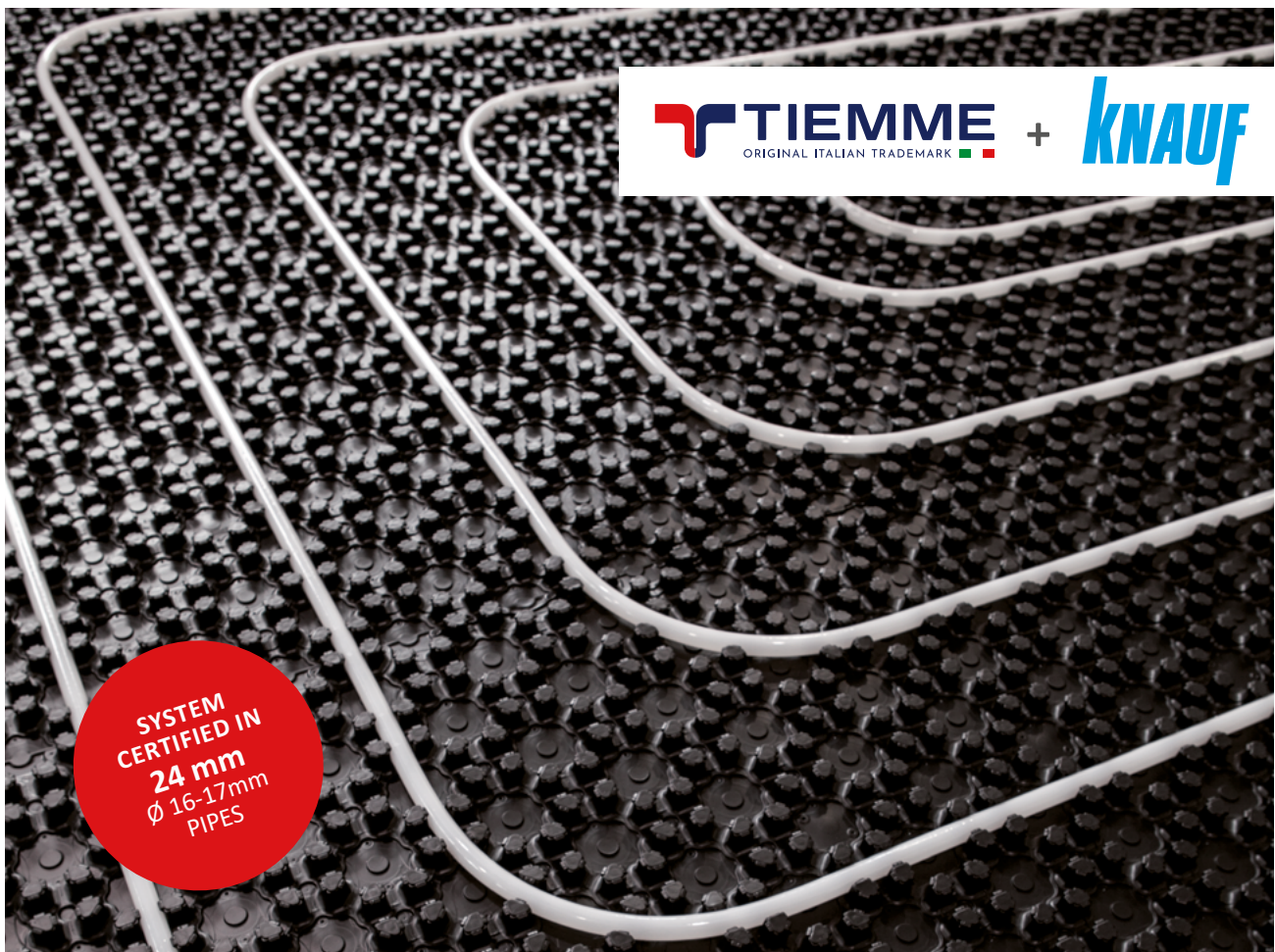

Low Black is the innovative Tiemme system created to meet the demand for low thermal inertia radiant systems. The choice of different thicknesses allows the application both in new buildings, ensuring the thermal resistance values required by UNI EN 1264, and during renovations when the priority becomes the containment of the overall dimensions of the plant. Made of expanded polystyrene sintered with graphite with high mechanical strength (EPS 300), it is particularly suitable for coupling with special screeds lowered up to 8 mm above the pipe. The panel is equipped with a 170 µm HIPS heat-sealed polystyrene protection layer as required by current legislation. It can be coupled with Ø 16x2 - 17x2 pipes, guarantees high flow rates and low pressure drop.

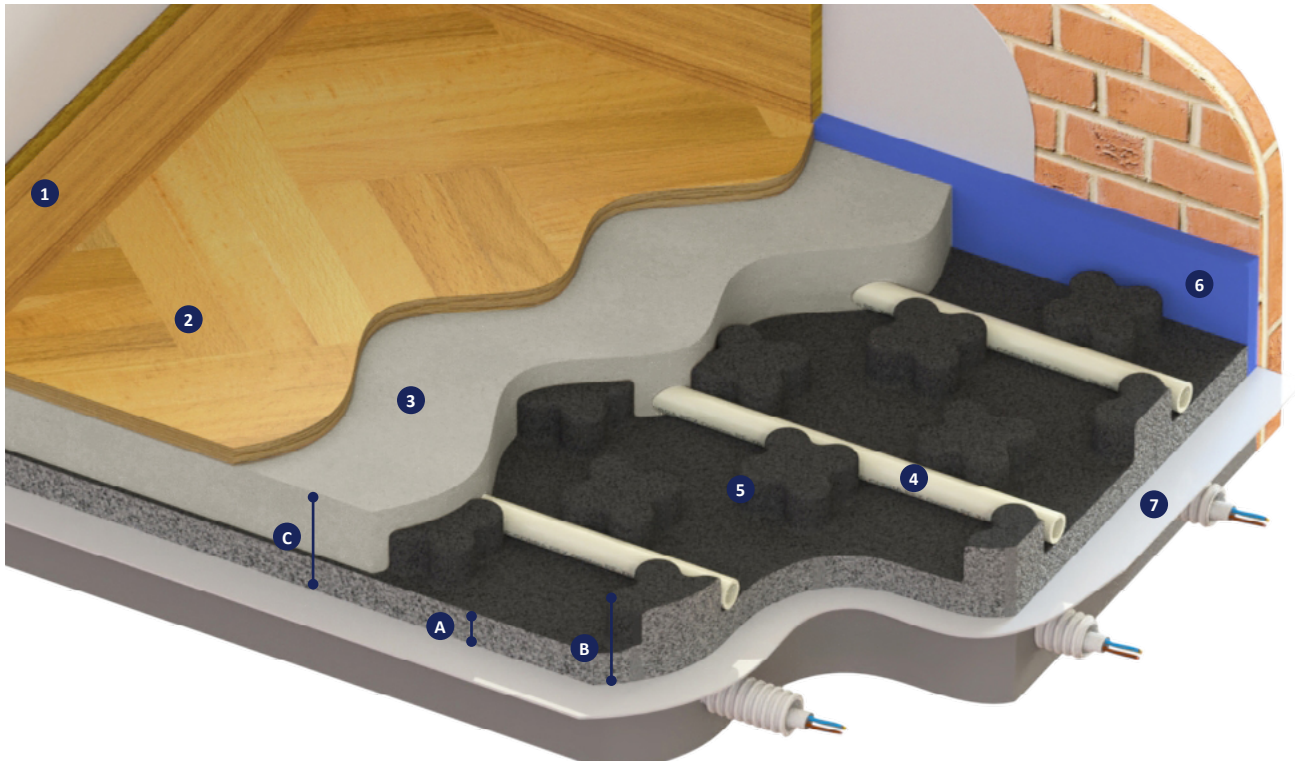

- | | |
|---------------------|--------------|
| 1. Skirting | - |
| 2. Coating | - |
| 3. Screed | - |
| 4. Pipe | art. 0200B |
| 5. Insulation panel | art. 4518GRF |
| 6. Perimeter strip | art. 4507 |
| 7. PE sheet | art. 4503 |

Code	Dimensions (mm)		
	A	B	C
450 0567	15	33	41 ÷ 58
450 0568	23	41	49 ÷ 66
450 0569	38	56	64 ÷ 81

THICKNESS ACCORDING TO UNI EN 1264

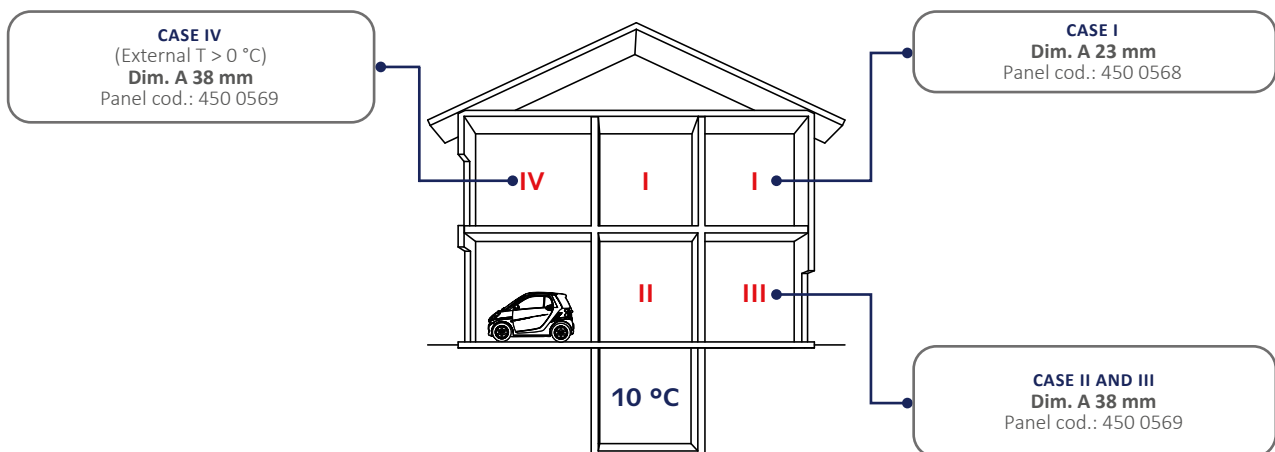

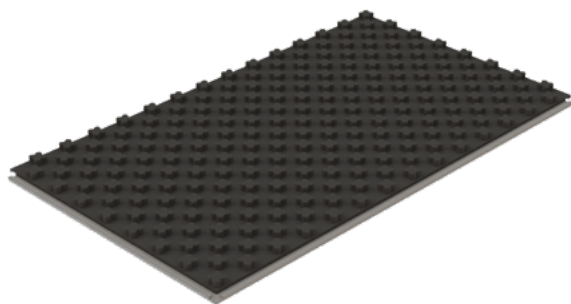

4518GRF

Insulating panel for floor radiant systems, made of closed cell sintered expanded polystyrene, with graphite additives, coupled with a protection layer in thermo-welded laminated polystyrene HIPS 170 µm, CE marked, suitable for radiant systems powered by water for heating and cooling integrated in the structures according to UNI EN 1264.

Code	Insulation thickness (mm)	C.R. 10% (kPa)	Price €/m ²	Packaging (m ²)	Packaging (no. panels)
450 0567	15	300		23,52/94,08	21
450 0568	23	300		17,92/71,68	16
450 0569	38	300		11,20/44,80	10

TECHNICAL CHARACTERISTICS

	Codes		
	450 0567	450 0568	450 0569
Thermal resistance EN 13163 (m ² k/W)	0,50	0,77	1,27
Compression resistance to 10% UNI EN 826 (kPa)	300		
Insulation thickness (mm)	15	23	38
Total thickness (mm)	33	41	56
Cover film (µm)	170		
Minimum pipe distance (mm)	50		
Thermal conductivity UNI EN 12667 (W/mk)	0,030		
Water absorption UNI EN 12087 (%)	5		
Reaction to fire EN 13501-1 (Euroclass)	E		
Total panel size (mm)	1425 x 825		
Useful panel size (mm)	1400 x 800		
Useful panel area(m ²)	1,12		
Panels per package (n)	21	16	10
Panel area per package (m ²)	23,52	17,92	11,20



0200B

High density COBRAPEX cross-linked polyethylene pipe with EVOH oxygen barrier.

TECHNICAL CHARACTERISTICS

- Maximum operating temperature: 95 °C
- Thermal conductivity: 0,38 W/mk
- Complies with EN ISO 15875-2
- Anti-oxygen barrier in EVOH compliant with DIN 4726
- Composition: PE-Xb

Code	Type	Price €/m	Unit/Box (m)
020 0005	16 x 2,0		120/3240
020 0018	16 x 2,0		200/3600
020 0003	16 x 2,0		300/3600
020 0001	16 x 2,0		600/3000
020 0008	17 x 2,0		120/3240
020 0071	17 x 2,0		200/3200
020 0006	17 x 2,0		300/2700
020 0002	17 x 2,0		600/3000



4507

Perimeter strip in expanded PE with adhesive back and PE sheet to contain mortar.

i With pre-cut H = 100 mm

Code	Type	Price €/m	Unit/Box (m)
450 0443	H 150 x 5 mm		50/250
450 0007	H 150 x 8 mm		25/125



1480P

Plastic 90-fold elbow for the protection and support of the COBRAPEX pipe near the connection to the distribution manifold.

Code	Type	Price €	Unit/Box
034 0077	Pipe Ø 16 - 18		25/500



4503

PE sheet with insulation function and moisture barrier.

TECHNICAL CHARACTERISTICS

- Width: 1,2 m
- Length: 100 m
- Thickness: 0,15 mm

Code	Type	Price €/m ²	Unit/Box (m ²)
450 0025	-		120/120



4539

Corrosion protection of metal parts with universal fungal bactericide for heating and cooling systems.

TECHNICAL CHARACTERISTICS

- Dosage: 1 l of additive x 100 l of circulating water

Code	Type	Price €	Unit/Box
450 0486	1 l		1/12



FROM TIEMME'S RADIANT TECHNOLOGY AND KNAUF SCREED KNOW HOW

THE INNOVATIVE LOW BLACK SYSTEM IS BORN.

Qk vertical concentrated load certified system by Elletipi S.r.l. laboratory with NE 425 Knauf self-leveling compound:

- LOW BLACK panel with EPS 300 insulation (insulation thickness 23 mm) combined with Knauf NE 425 self-leveling compound from 8 mm thickness above the pipe



HIGH MECHANICAL STRENGTH

EPS 300



PANEL WITH ASHLAR

Maximum ease of installation



LOW THERMAL INERTIA



PANEL WITH GRAPHITE ADDITIVES

IDEAL FOR NEW BUILDINGS WITH HIGH ENERGY EFFICIENCY.



Dry is the innovative Tiemme dry system created to meet the demand for radiant systems with low thermal inertia dry type. The possibility of choosing between different thicknesses allows the application both in new buildings, guaranteeing the thermal resistance values required by UNI EN 1264, and during renovations, where the priority becomes the containment of the plant footprint. Laying extremely fast, does not require drying time of the screed. High heat conductivity thanks to 0.15mm aluminium foil pre-coupled with EPS panel. Available with 150 mm and 100 mm pipe distance for maximum performance in both winter and summer operation. Made of expanded polystyrene sintered with graphite with high mechanical strength (EPS 300), it can be coupled with Ø 16x2 mm pipes, ensuring high flow rates and low pressure drops. The ceramic flooring can be directly glued to the panel after protection by means of a special primer of the aluminium foil, for pre-finished wooden floors, floating or glued laying is recommended in combination with a special low cement level.

DRY - GLUED CERAMIC LAYING

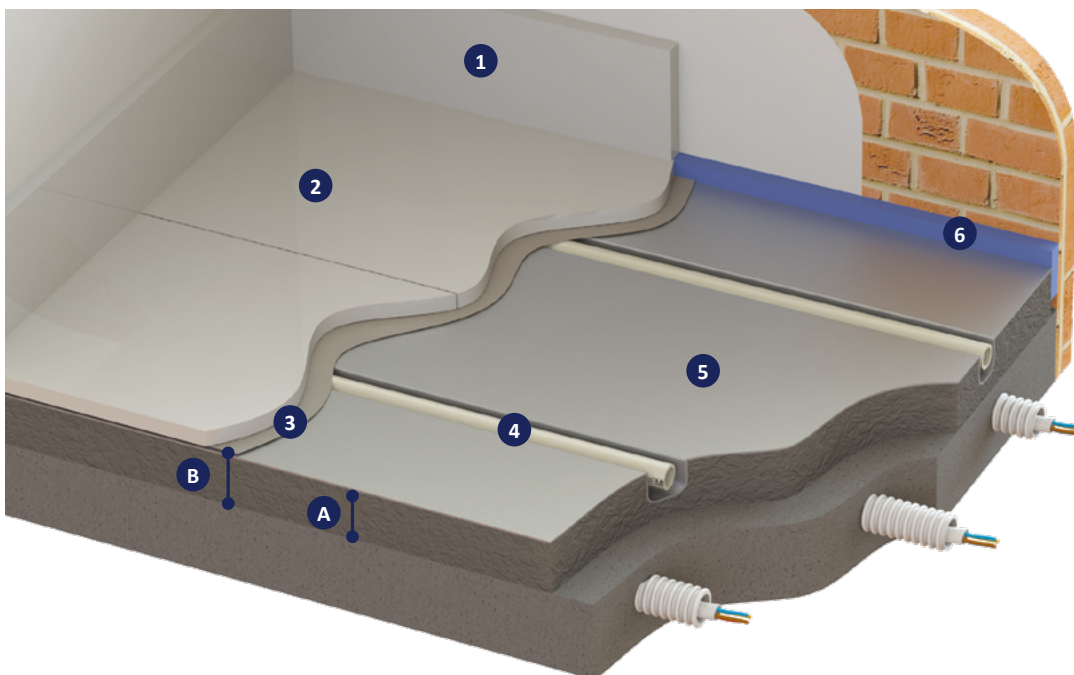

- | | |
|---------------------|--------------|
| 1. Skirting | - |
| 2. Ceramic coating | - |
| 3. Glue | - |
| 4. Pipe | art. 0200B |
| 5. Insulation panel | art. 4517GRF |
| 6. Perimeter strip | art. 4507 |

Code	Dimensions (mm)	
	A	B
450 0562	26	29
450 0564	26	29
450 0563	42	45
450 0565	42	45



DRY - LAYING GLUED PARQUET

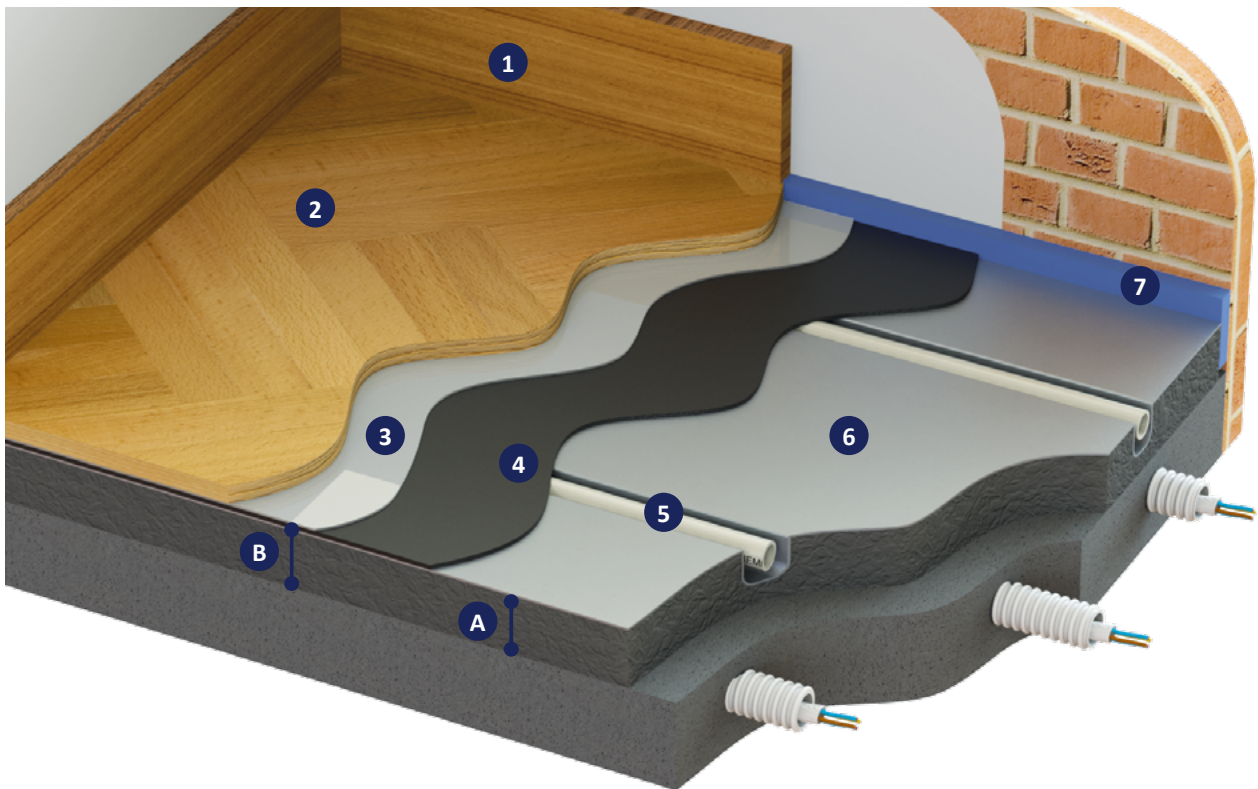

- | | |
|------------------------------------|--------------|
| 1. Skirting | - |
| 2. Coating in glued parquet | - |
| 3. Glue | - |
| 4. Mat (Isolmant Isoltile AD type) | - |
| 5. Pipe | art. 0660 |
| 6. Insulation panel | art. 4517GRF |
| 7. Perimeter strip | art. 4507 |

Code	Dimensions (mm)	
	A	B
450 0562	26	30
450 0564	26	30
450 0563	42	46
450 0565	42	46

Suitable system for glued prefinished parquet, not suitable for solid parquet to be sanded on site for which we recommend the Low Black system.

DRY - INSTALLATION OF FLOATING PARQUET

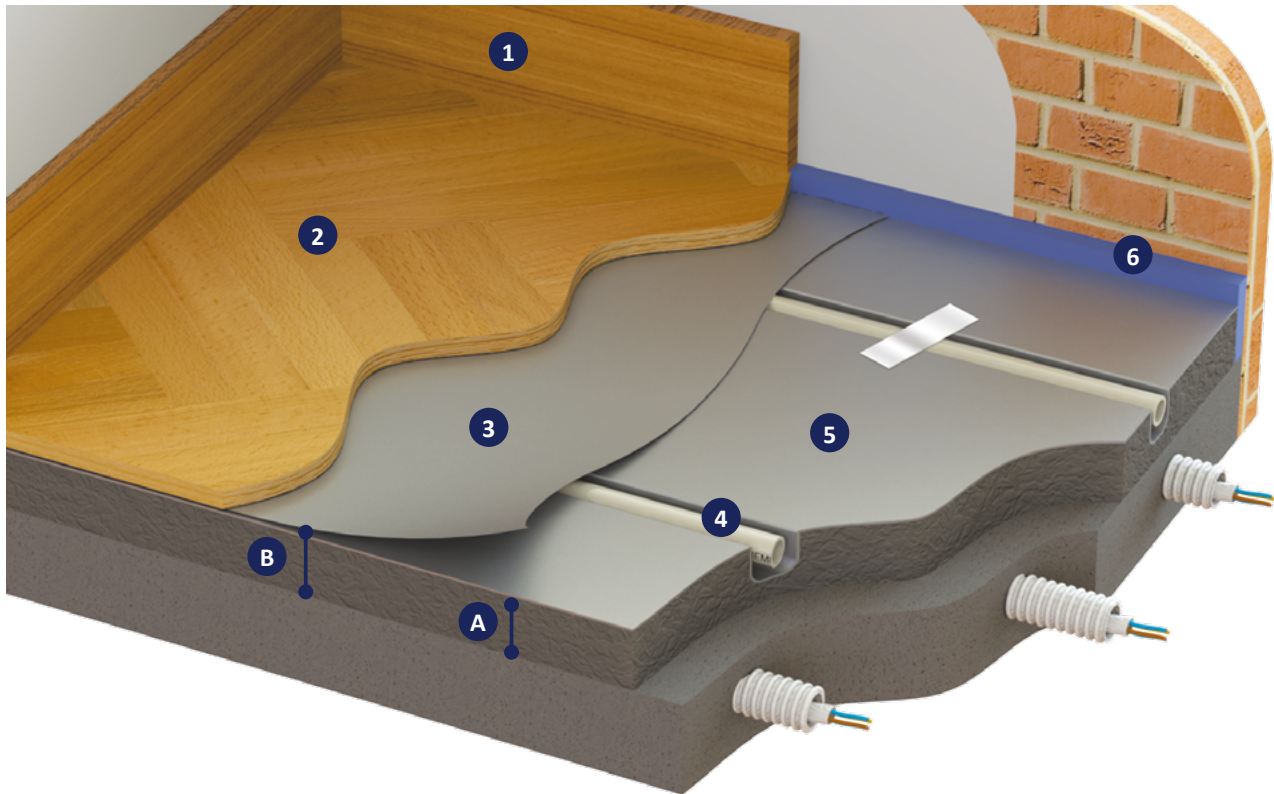

1. Skirting
2. Coating in floating parquet
3. Separating mat (Isolmant TOP Type)
4. Pipe
5. Insulation panel
6. Perimeter strip

-
-
-
art. 0660
art. 4517GRF
art. 4507

Code	Dimensions (mm)	
	A	B
450 0562	26	28
450 0564	26	28
450 0563	42	44
450 0565	42	44



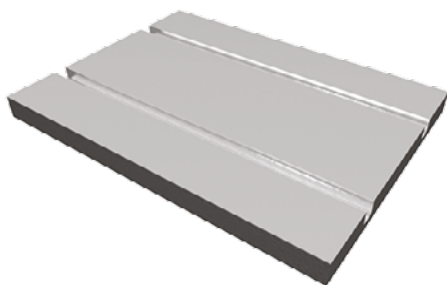

4517GRF

Insulating panel for dry floor radiant systems in EPS 300, with graphite additives, pre-coupled to a 1050 alloy aluminium foil with high thermal conductivity. Low thermal inertia due to the absence of screed that allows fast response times. Suitable for heating and cooling systems is available with 100 or 150 mm pipe distance.

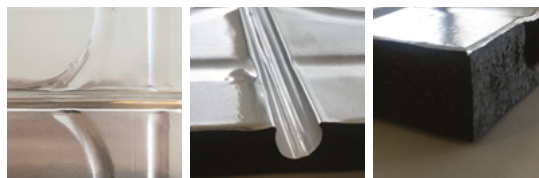

Code	Thickness (mm)	Centre distance (mm)	C.R. 10% (kPa)	Price €/m ²	Packaging (m ²)	Packaging (no. panels)
450 0562	26	100	300		11,20/89,60	10
450 0563	42	100	300		6,72/53,76	6
450 0564	26	150	300		10,5/84	10
450 0565	42	150	300		6,30/50,40	6

TECHNICAL CHARACTERISTICS

	Codes			
	450 0562	450 0563	450 0564	450 0565
Insulation thickness (mm)	26	42	26	42
Total thickness (mm)	26	42	26	42
Aluminium Alloy/ Thickness (mm)	1050/ 0,15			
Declared thermal conductivity (W/mk)	0,031			
Thermal resistance R_{λ,ins} (m²k/W)	0,75	1,27	0,75	1,26
Compressive strength at 10% deformation (kPa)	300			
Reaction to fire (Euroclass)	E			
Total panel size (mm)	1400 x 800		1400 x 750	
Minimum pipe distance (mm)	100		150	
Useful panel area (m ²)	1,12		1,05	

THICKNESS ACCORDING TO UNI EN 1264

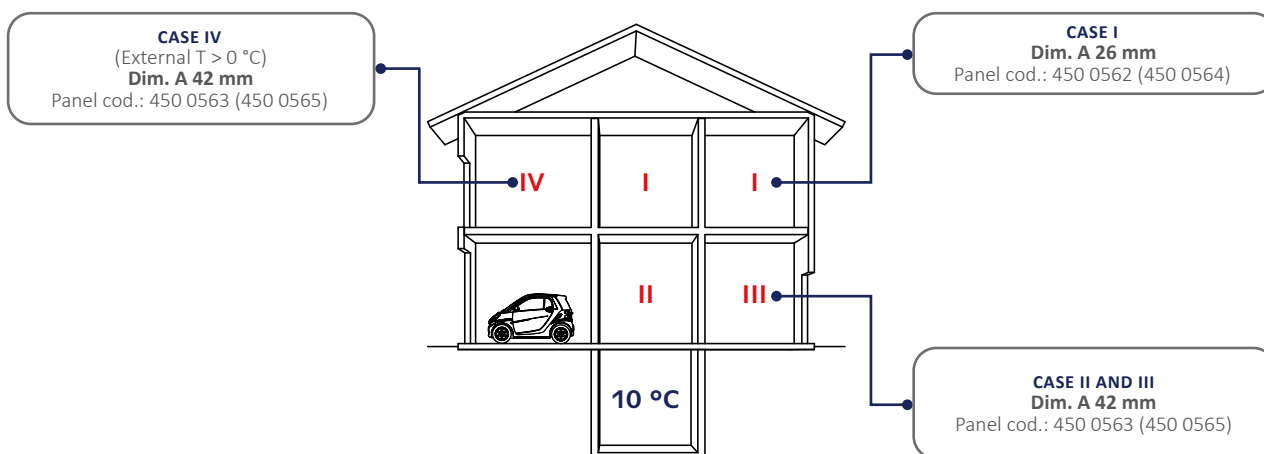

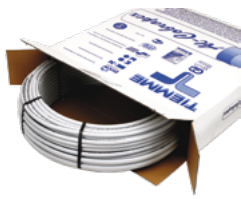

0660

Cross-linked polyethylene pipe with aluminium core - White. In rolls

Code	Type	Alum.	Price €/m	Unit/Box (m)
060 0001	16 x 2,0	0,20		100/3200
060 0010	16 x 2,0	0,20		200/3000



0660S

Cross-linked polyethylene pipe with aluminium core, without box - White

Code	Type	Alum.	Price €/m	Unit/Box (m)
060 0015	16 x 2,0	0,20		500/6000



0200B

High density COBRAPEX cross-linked polyethylene pipe with EVOH oxygen barrier.

TECHNICAL CHARACTERISTICS

- Maximum operating temperature: 95 °C
- Thermal conductivity: 0,38 W/mk
- Complies with EN ISO 15875-2
- Anti-oxygen barrier in EVOH compliant with DIN 4726
- Composition: PE-Xb

Code	Type	Price €/m	Unit/Box (m)
020 0005	16 x 2,0		120/3240
020 0018	16 x 2,0		200/3600
020 0003	16 x 2,0		300/3600
020 0001	16 x 2,0		600/3000



4507

Perimeter strip in expanded PE with adhesive back and PE sheet to contain mortar.

i With pre-cut H = 100 mm

Code	Type	Price €/m	Unit/Box (m)
450 0443	H 150 x 5 mm		50/250
450 0007	H 150 x 8 mm		25/125



1480P

Plastic 90-fold elbow for the protection and support of the COBRAPEX pipe near the connection to the distribution manifold.

Code	Type	Price €	Unit/Box
034 0077	Pipe Ø 16 - 18		25/500



4517NA

Reinforced aluminium adhesive tape.

TECHNICAL CHARACTERISTICS

- Width: 50 mm
- Length: 50 m
- Thickness: 30 µm

Code	Type	Price €	Unit/Box
450 0566	-		1/24



4539

Corrosion protection of metal parts with universal fungal bactericide for heating and cooling systems.

TECHNICAL CHARACTERISTICS

- Dosage: 1 l of additive x 100 l of circulating water

Code	Type	Price €	Unit/Box
450 0486	1 l		1/12



FROM THE RADIANT TECHNOLOGY SIGNED TIEMME AND OUR EXPERIENCE IN THE FIELD

THE INNOVATIVE DRY SYSTEM IS BORN.



REDUCED TIME

Plant at full speed in less than an hour



SPEED OF INSTALLATION

No drying time for the screed



LOW THERMAL INERTIA



LOW THICKNESS

IDEAL FOR NEW ENERGY EFFICIENT BUILDINGS AND RENOVATIONS



GUIDE TO THE CHOICE OF THICKNESSES ACCORDING TO UNI EN 1264

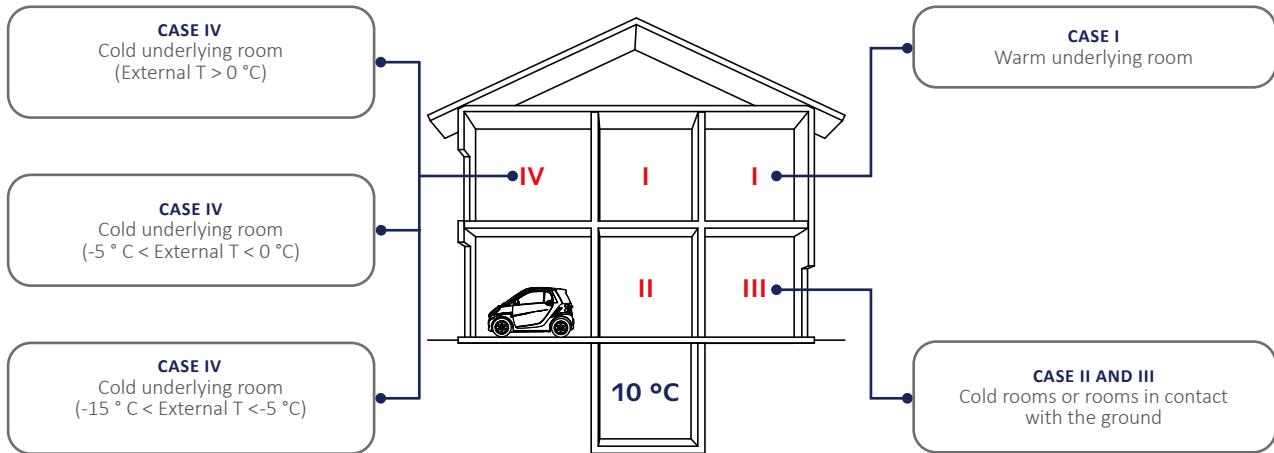

	R_0 (m ² K/W)	Minimum required equivalent total thickness (mm)		
		Polyurethane $\lambda_b = 0,023$ (W/mK)	EPS with graphite $\lambda_b = 0,030$ (W/mK)	EPS $\lambda_b = 0,035$ (W/mK)
Case I	0,75	17,5	22,5	26,5
Cases II and III	1,25	29	37,5	44
Case IV (External T > 0 °C)	1,25	29	37,5	44
Case IV (-5 °C < External T < 0 °C)	1,50	34,5	45	53
Case IV (-15 °C < External T < -5 °C)	2,00	46	60	70



TIEMME'S SOLUTION

NEW CLASSIC GRAPHITE

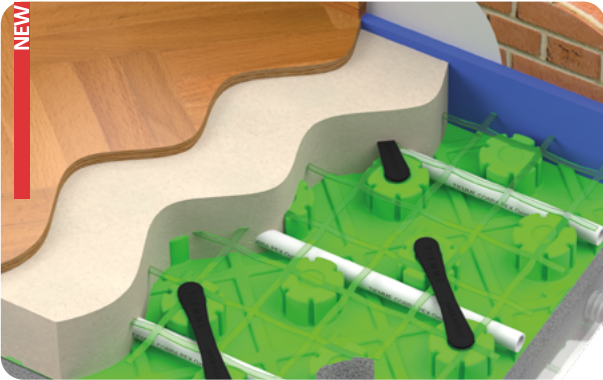

TECHNO GRAPHITE CAM

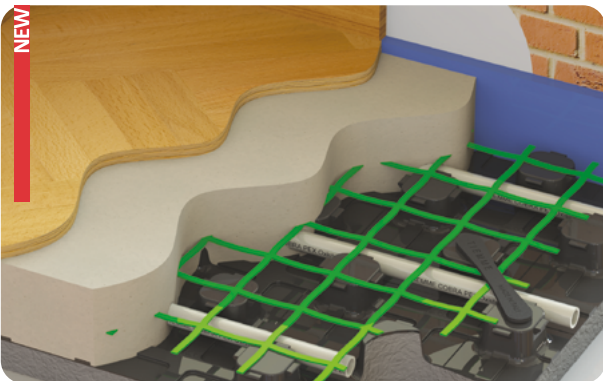

BASIC

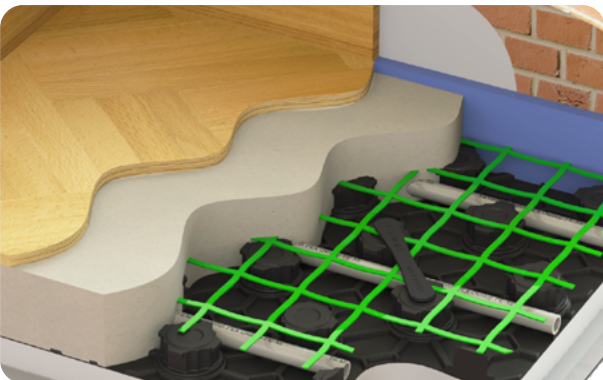

CLIP GRAPHITE

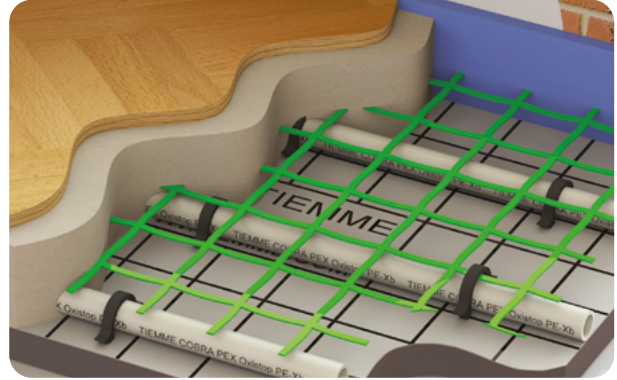

CLIP SUPER

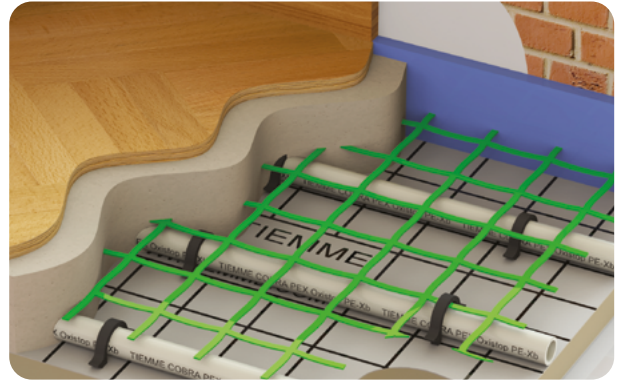

Ideal solution for residential and commercial heating and cooling systems. The panel with ashlars is the result of the coupling between a base in expanded polystyrene with graphite additives, obtained with the best moulding techniques, and a sheet of polystyrene with thickness 0.16 mm. The result is a panel that is easy to use and available in different thicknesses ranging from 10 to 60 mm, all certified and equipped with excellent compressive strength. The coupling between the panels is guaranteed by a special coupling system with perimeter joints. 50 mm and multiple pipe distances. Meets the new thermal resistance requirements of UNI EN 1264:2021

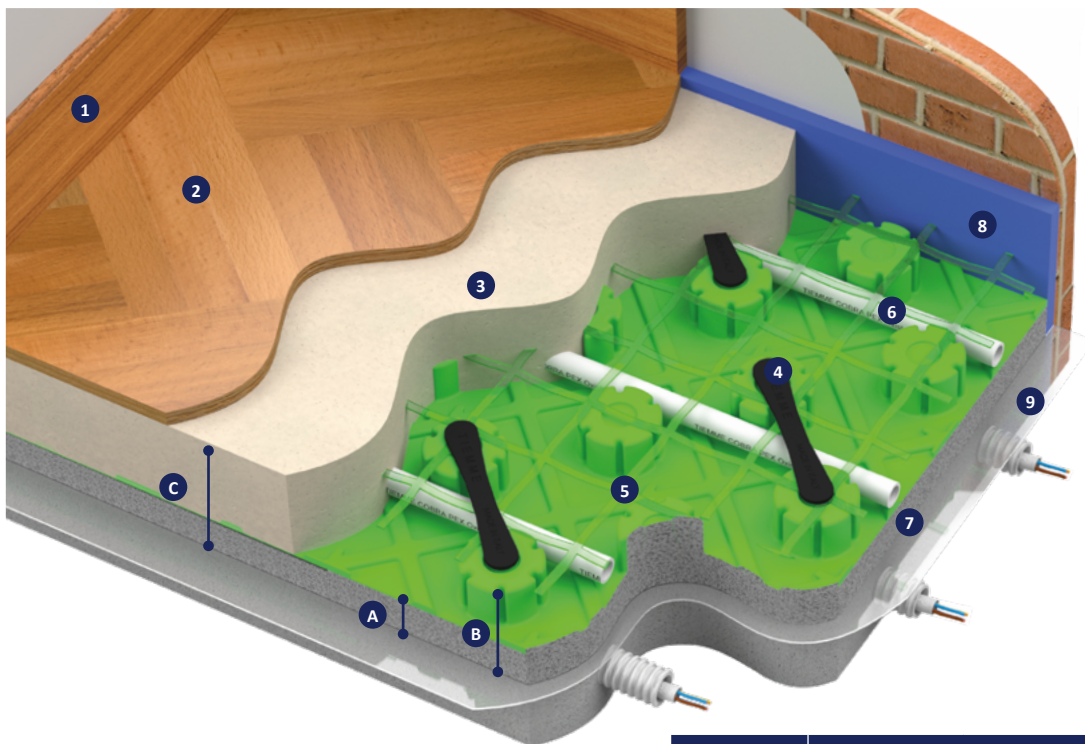

- | | |
|---------------------|--------------|
| 1. Skirting | - |
| 2. Coating | - |
| 3. Screed | - |
| 4. Mesh fixing clip | art. 4527 |
| 5. Fiberglass mesh | art. 4532 |
| 6. Pipe | art. 0200B |
| 7. Insulation panel | art. 4524GRF |
| 8. Perimeter strip | art. 4507 |
| 9. PE sheet | art. 4503 |

Code	Dimensions (mm)		
	A	B	C
450 0479	10	34	60 ÷ 70
450 0721	23	47	73 ÷ 83
450 0722	38	62	88 ÷ 98
450 0725	45	69	95 ÷ 105
450 0726	60	84	110 ÷ 120

THICKNESS ACCORDING TO UNI EN 1264

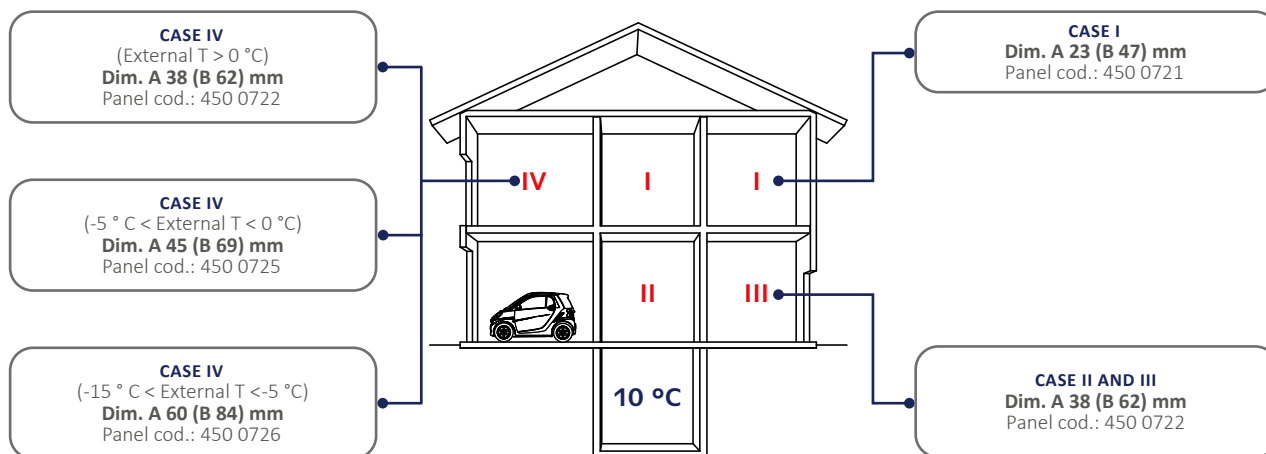

NEW

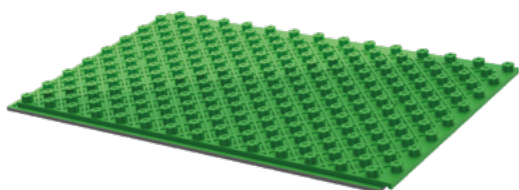

4524GRF

Insulating panel in sintered expanded polystyrene with graphite additives in compliance with UNI EN 13163. It is equipped with reliefs (ashlars) for the locking of the pipe - 50 mm pipe distance – and interlocking grooves on the perimeter for a solid joint between panels.

Insulation thickness complies with UNI EN 1264:2021

Code	Insulation thickness (mm)	C.R. 10% (kPa)	Price €/m ²	Packaging (m ²)	Packaging (no. panels)
450 0479	10	250		21,12/84,48	22
450 0721	23	150		15,68/62,72	14
450 0722	38	150		11,20/44,80	10
450 0725	45	150		8,96/35,84	8
450 0726	60	150		7,84/31,36	7

TECHNICAL CHARACTERISTICS

	Codes				
	450 0479	450 0721	450 0722	450 0725	450 0726
Thermal resistance EN 13163 (m ² k/W)	0,33	0,75	1,25	1,50	2,00
Compression resistance to 10% UNI EN 826 (kPa)	250	150			
Insulation thickness (mm)	10	23	38	45	60
Total thickness (mm)	34	47	62	69	84
Cover film (µm)	160				
Minimum pipe distance (mm)	50				
Thermal conductivity UNI EN 12667 (W/mk)	0,030				
Water absorption UNI EN 12087 (%)	7	4			
Reaction to fire EN 13501-1 (Euroclass)	E				
Total panel size (mm)	1220 x 820	1425 x 825			
Useful panel size (mm)	1220 x 820	1400 x 800			
Useful panel area(m ²)	0,96	1,12			
Panels per package (n)	22	14	10	8	7
Panel area per package (m ²)	21,12	15,68	11,20	8,96	7,84



0200B

High density COBRAPEX cross-linked polyethylene pipe with EVOH oxygen barrier.

TECHNICAL CHARACTERISTICS

- Maximum operating temperature: 95 °C
- Thermal conductivity: 0,38 W/mk
- Complies with EN ISO 15875-2
- Anti-oxygen barrier in EVOH compliant with DIN 4726
- Composition: PE-Xb

Code	Type	Price €/m	Unit/Box (m)
020 0005	16 x 2,0		120/3240
020 0018	16 x 2,0		200/3600
020 0003	16 x 2,0		300/3600
020 0001	16 x 2,0		600/3000
020 0008	17 x 2,0		120/3240
020 0071	17 x 2,0		200/3200
020 0006	17 x 2,0		300/2700
020 0002	17 x 2,0		600/3000



4507

Perimeter strip in expanded PE with adhesive back and PE sheet to contain mortar.

i With pre-cut H = 100 mm

Code	Type	Price €/m	Unit/Box (m)
450 0443	H 150 x 5 mm		50/250
450 0007	H 150 x 8 mm		25/125



1480P

Plastic 90-fold elbow for the protection and support of the COBRAPEX pipe near the connection to the distribution manifold.

Code	Type	Price €	Unit/Box
034 0077	Pipe Ø 16 - 18		25/500



4527

Clip for fixing the mesh. Made of plastic material and complete of anchoring fins.

Code	Type	Price €	Unit/Box
450 0018	H = 28 mm		100/1000



4540

Screed additive in aqueous solution composed of acrylic polymers; reduces hygroscopic withdrawals by increasing the thermal resistance and improving thermal conductivity.

TECHNICAL CHARACTERISTICS

- Dosage: 1 kg of additive x 100 Kg of cement

Code	Type	Price €/kg	Unit/Box (kg)
450 0019	10 Kg ≈ 9,6 l		10/10
450 0017	25 Kg ≈ 24 l		25/25



4508

PE expansion joint, self-adhesive base for smooth and panel with ashlar.

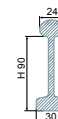

TECHNICAL CHARACTERISTICS

- Height: 90 mm
- Length: 2 m

Code	Type	Price €/m	Unit/Box (m)
450 0023	-		20/180

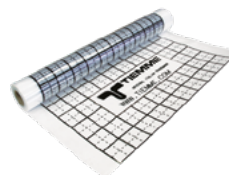

4503

PE sheet with insulation function and moisture barrier.

TECHNICAL CHARACTERISTICS

- Width: 1,2 m
- Length: 100 m
- Thickness: 0,15 mm

Code	Type	Price €/m ²	Unit/Box (m ²)
450 0025	-		120/120



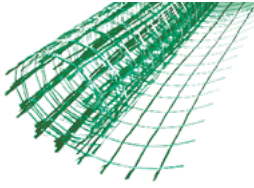

4532

Fiberglass mesh treated for the reinforcement of concrete screeds.

TECHNICAL CHARACTERISTICS

- Mesh size: 40 x 40 mm
- Weight: 130 g/m²

 2 mm wire mesh on request.

Code	Type	Price €/m ²	Unit/Box (m ²)
450 0152	1 m x 50 m		50/400
450 0022	1 m x 100 m		100/400



4539

Corrosion protection of metal parts with universal fungal bactericide for heating and cooling systems.

TECHNICAL CHARACTERISTICS

- Dosage: 1 l of additive x 100 l of circulating water

Code	Type	Price €	Unit/Box
450 0486	1 l		1/12

Ideal solution for residential and commercial heating and cooling systems. The thermoformed panel with ashlars allows to obtain low thickness and is therefore also suitable for renovations.

Maximum protection from thermal bridges. 50 mm and multiple pipe distances. The coupling between the panels is guaranteed by the overlap of side ashlars.

Meets the new thermal resistance requirements of UNI EN 1264:2021

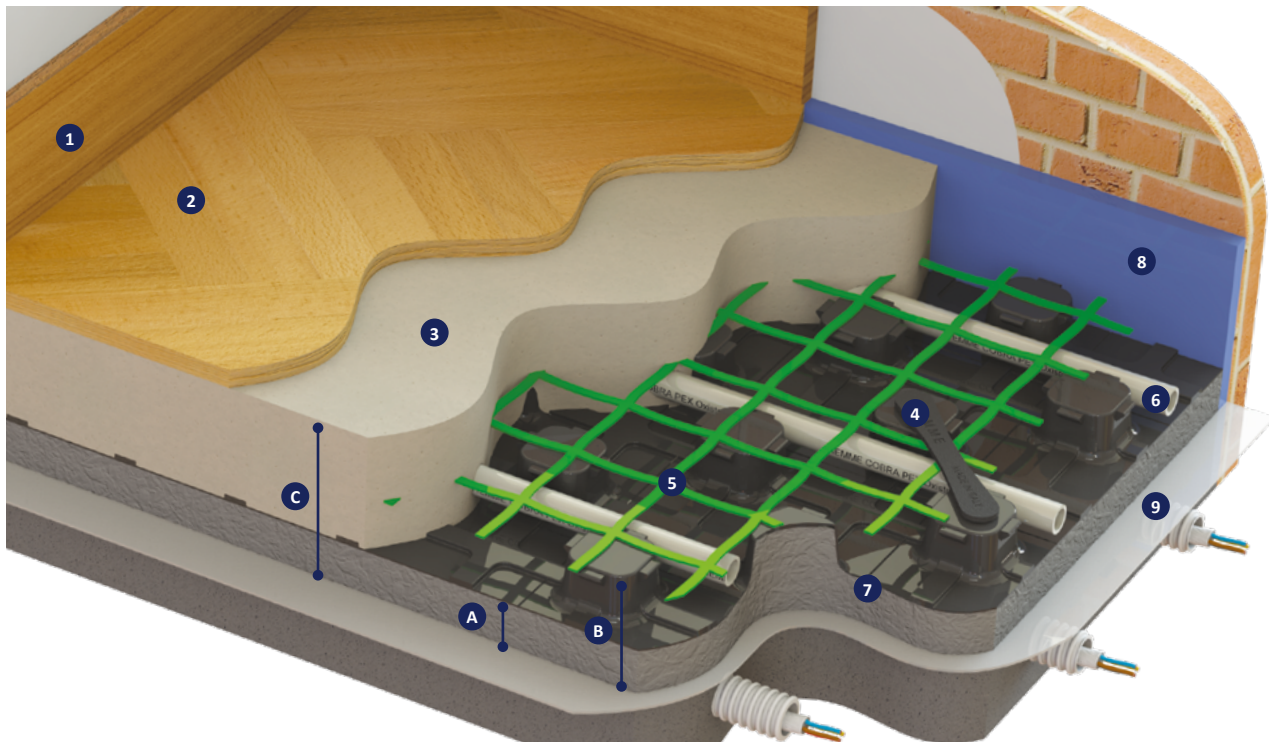

- 1. Skirting -
- 2. Coating -
- 3. Screed -
- 4. Mesh fixing clip art. 4527
- 5. Fiberglass mesh art. 4532
- 6. Pipe art. 0200B
- 7. Insulation panel art. 4528PANGRF
- 8. Perimeter strip art. 4507
- 9. PE sheet art. 4503

Code	Dimensions (mm)		
	A	B	C
450 0729	10	32	60 ÷ 70
450 0730	23	45	73 ÷ 85
450 0731	38	60	88 ÷ 98
450 0732	45	67	95 ÷ 105
450 0733	60	82	110 ÷ 120

THICKNESS ACCORDING TO UNI EN 1264

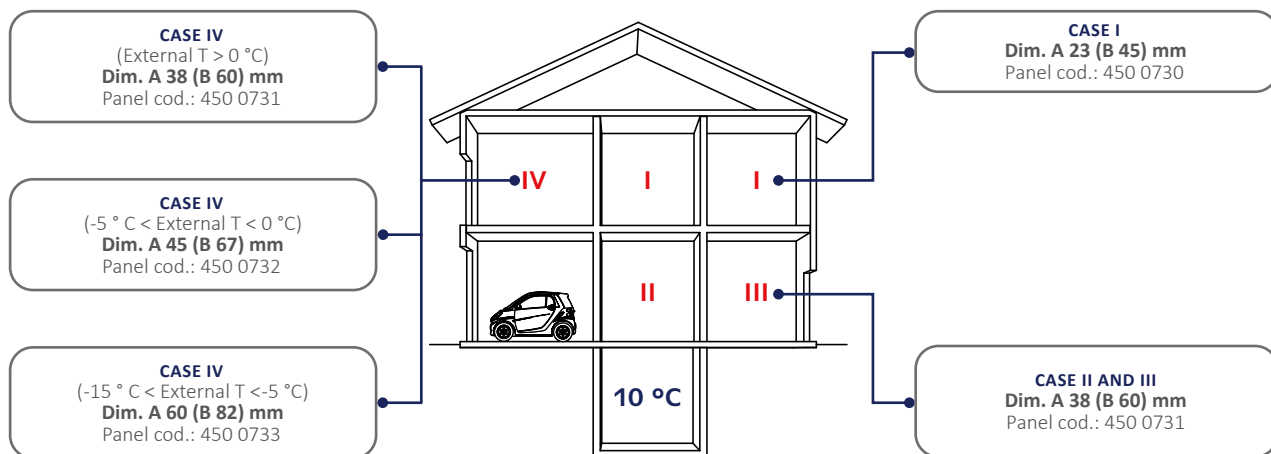

NEW

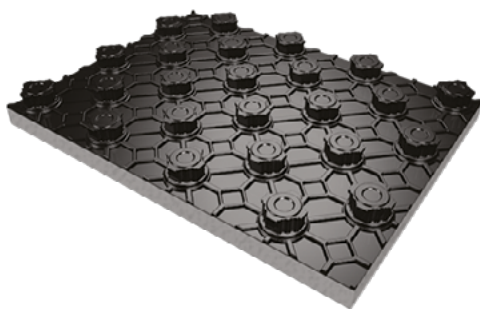

4528PANGRF

Thermoformed panel with ashlars in expanded polystyrene sintered with graphite coupled to a rigid black polystyrene foil with ashlars.

Conforming to EN 13163, it is equipped with reliefs for locking the pipe (50 mm pipe distance) and male/female joints for a solid joint.

The rigid sheet gives the panel greater resistance to wear and tear. The joint male/ female perimeter allows the overlapping of the sheets and makes it perfectly compatible with self-levelling liquid screeds.

Insulation thickness complies with UNI EN 1264:2021

Code	Insulation thickness (mm)	C.R. 10% (kPa)	Price €/m ²	Packaging (m ²)	Packaging (no. panels)
450 0729	10	200		20,16/100,8	18
450 0730	23	150		12,32/61,60	11
450 0731	38	150		8,96/44,80	8
450 0732	45	150		7,84/39,20	7
450 0733	60	150		5,60/28,00	5

TECHNICAL CHARACTERISTICS

	Codes				
	450 0729	450 0730	450 0731	450 0732	450 0733
Thermal resistance EN 13163 (m ² k/W)	0,33	0,75	1,25	1,50	2,00
Compression resistance to 10% UNI EN 826 (kPa)	200	150			
Insulation thickness (mm)	10	23	38	45	60
Total thickness (mm)	32	45	60	67	82
Total thickness equivalente UNI EN 1264/3 (mm)	0,6				
Minimum pipe distance (mm)	50				
Thermal conductivity UNI EN 12667 (W/mk)	0,030				
Water absorption UNI EN 12087 (%)	6,5	4,0			
Reaction to fire EN 13501-1 (Euroclass)	E				
Total panel size (mm)	1450 X 850				
Useful panel size (mm)	1400 X 800				
Useful panel area(m ²)	1,12				
Panels per package (n)	18	11	8	7	5
Panel area per package (m ²)	20,16	12,32	8,96	7,84	5,60



0200B

High density COBRAPEX cross-linked polyethylene pipe with EVOH oxygen barrier.

TECHNICAL CHARACTERISTICS

- Maximum operating temperature: 95 °C
- Thermal conductivity: 0,38 W/mk
- Complies with EN ISO 15875-2
- Anti-oxygen barrier in EVOH compliant with DIN 4726
- Composition: PE-Xb

Code	Type	Price €/m	Unit/Box (m)
020 0005	16 x 2,0		120/3240
020 0018	16 x 2,0		200/3600
020 0003	16 x 2,0		300/3600
020 0001	16 x 2,0		600/3000
020 0008	17 x 2,0		120/3240
020 0071	17 x 2,0		200/3200
020 0006	17 x 2,0		300/2700
020 0002	17 x 2,0		600/3000



4507

Perimeter strip in expanded PE with adhesive back and PE sheet to contain mortar.

i With pre-cut H = 100 mm

Code	Type	Price €/m	Unit/Box (m)
450 0443	H 150 x 5 mm		50/250
450 0007	H 150 x 8 mm		25/125



1480P

Plastic 90-fold elbow for the protection and support of the COBRAPEX pipe near the connection to the distribution manifold.

Code	Type	Price €	Unit/Box
034 0077	Pipe Ø 16 - 18		25/500



4527

Clip for fixing the mesh. Made of plastic material and complete of anchoring fins.

Code	Type (mm)	Price €	Unit/Box
450 0018	H = 28		100/1000



4540

Screed additive in aqueous solution composed of acrylic polymers; reduces hygroscopic withdrawals by increasing the thermal resistance and improving thermal conductivity.

TECHNICAL CHARACTERISTICS

- Dosage: 1 kg of additive x 100 Kg of cement

Code	Type	Price €/kg	Unit/Box (kg)
450 0019	10 Kg ≈ 9,6 l		10/10
450 0017	25 Kg ≈ 24 l		25/25



4508

PE expansion joint, self-adhesive base for smooth and panel with ashlar.

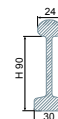

TECHNICAL CHARACTERISTICS

- Height: 90 mm
- Length: 2 m

Code	Type	Price €/m	Unit/Box (m)
450 0023	-		20/180

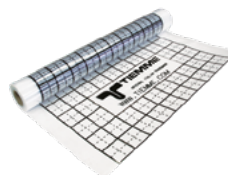

4503

PE sheet with insulation function and moisture barrier.

TECHNICAL CHARACTERISTICS

- Width: 1,2 m
- Length: 100 m
- Thickness: 0,15 mm

Code	Type	Price €/m ²	Unit/Box (m ²)
450 0025	-		120/120



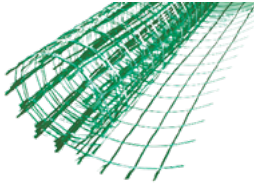

4532

Fiberglass mesh treated for the reinforcement of concrete screeds.

TECHNICAL CHARACTERISTICS

- Mesh size: 40 x 40 mm
- Weight: 130 g/m²

 2 mm wire mesh on request.

Code	Type	Price €/m ²	Unit/Box (m ²)
450 0152	1 m x 50 m		50/400
450 0022	1 m x 100 m		100/400



4539

Corrosion protection of metal parts with universal fungal bactericide for heating and cooling systems.

TECHNICAL CHARACTERISTICS

- Dosage: 1 l of additive x 100 l of circulating water

Code	Type	Price €	Unit/Box
450 0486	1 l		1/12

Ideal solution for residential and commercial heating and cooling systems. The thermoformed panel with ashlars allows to obtain low thickness and is therefore also suitable for renovations.
Maximum protection from thermal bridges. 50 mm and multiple pipe distances. The coupling between the panels is guaranteed by the overlap of side ashlars.

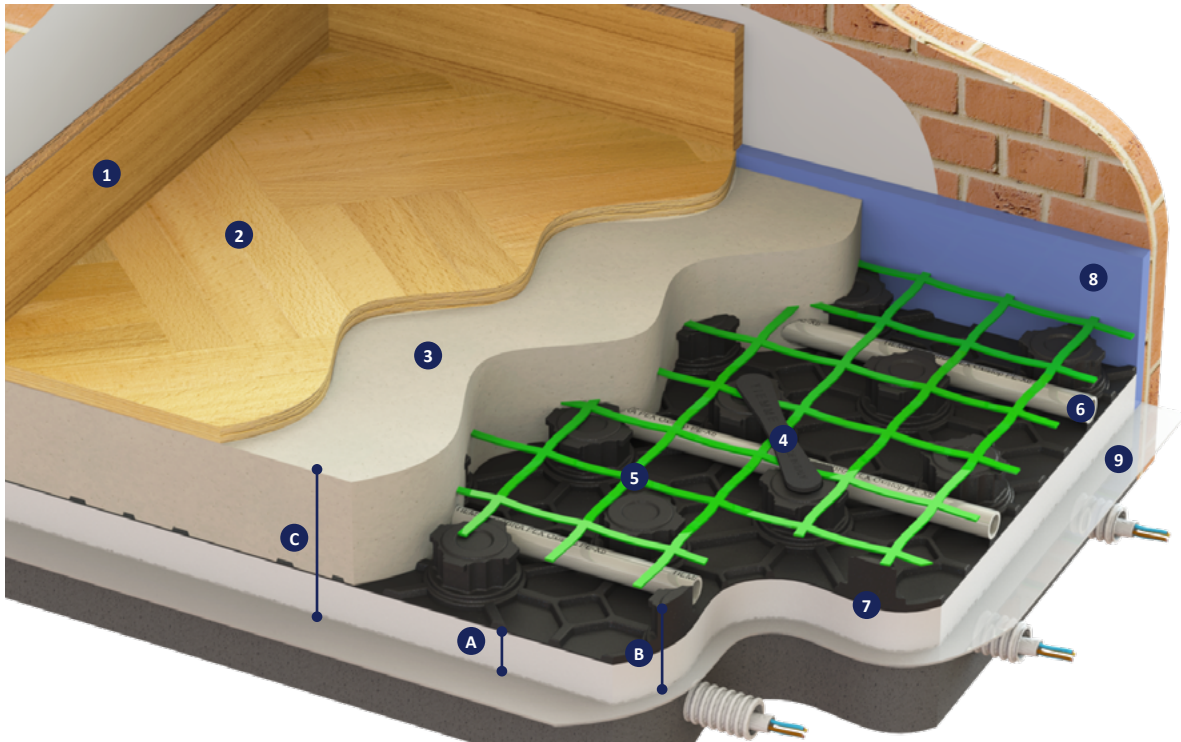

- | | |
|---------------------|--------------|
| 1. Skirting | - |
| 2. Coating | - |
| 3. Screed | - |
| 4. Mesh fixing clip | art. 4527 |
| 5. Fiberglass mesh | art. 4532 |
| 6. Pipe | art. 0200B |
| 7. Insulation panel | art. 4501PAN |
| 8. Perimeter strip | art. 4507 |
| 9. PE sheet | art. 4503 |

Code	Dimensions (mm)		
	A	B	C
450 0570	10	32	60 ÷ 70
450 0531	20	42	70 ÷ 80
450 0532	30	52	80 ÷ 90
450 0687	40	62	90 ÷ 100





4501PAN

Thermoformed panel with ashlar in sintered expanded polystyrene coupled to a rigid black polystyrene sheet with ashlar. Conforming to EN 13163, it is equipped with reliefs for locking the pipe (50 mm pipe distance) and male/female joints for a solid joint. The rigid sheet gives the panel greater resistance to wear and tear.

The joint male/ female perimeter allows the overlapping of the sheets and makes it perfectly compatible with self-levelling liquid screeds.

Code	Insulation thickness (mm)	C.R. 10% (kPa)	Price €/m ²	Packaging (m ²)	Packaging (no. panels)
450 0570	10	150		20,16/100,8	18
450 0531	20	150		13,44/67,2	12
450 0532	30	150		11,2/56	10
450 0687	40	150		8,96/44,8	8

TECHNICAL CHARACTERISTICS

	Codes			
	450 0570	450 0531	450 0532	450 0687
Thermal resistance EN 13163 (m ² k/W)	0,29	0,59	0,88	1,18
Compression resistance to 10% UNI EN 826 (kPa)	150			
Insulation thickness (mm)	10	20	30	40
Total thickness (mm)	32	42	52	62
Rigid cover sheet (mm)	0,5			
Minimum pipe distance (mm)	50			
Thermal conductivity UNI EN 12667 (W/mk)	0,034			
Water absorption UNI EN 12087 (%)	0,5			
Reaction to fire EN 13501-1 (Euroclass)	E			
Total panel size (mm)	1450 X 850			
Useful panel size (mm)	1400 X 800			
Useful panel area(m ²)	1,12			
Panels per package (n)	18	12	10	8
Panel area per package (m ²)	20,16	13,44	11,20	8,96



0200B

High density COBRAPEX cross-linked polyethylene pipe with EVOH oxygen barrier.

TECHNICAL CHARACTERISTICS

- Maximum operating temperature: 95 °C
- Thermal conductivity: 0,38 W/mk
- Complies with EN ISO 15875-2
- Anti-oxygen barrier in EVOH compliant with DIN 4726
- Composition: PE-Xb

Code	Type	Price €/m	Unit/Box (m)
020 0005	16 x 2,0		120/3240
020 0018	16 x 2,0		200/3600
020 0003	16 x 2,0		300/3600
020 0001	16 x 2,0		600/3000
020 0008	17 x 2,0		120/3240
020 0071	17 x 2,0		200/3200
020 0006	17 x 2,0		300/2700
020 0002	17 x 2,0		600/3000



4507

Perimeter strip in expanded PE with adhesive back and PE sheet to contain mortar.

i With pre-cut H = 100 mm

Code	Type	Price €/m	Unit/Box (m)
450 0443	H 150 x 5 mm		50/250
450 0007	H 150 x 8 mm		25/125



1480P

Plastic 90-fold elbow for the protection and support of the COBRAPEX pipe near the connection to the distribution manifold.

Code	Type	Price €	Unit/Box
034 0077	Pipe Ø 16 - 18		25/500



4527

Clip for fixing the mesh. Made of plastic material and complete of anchoring fins.

Code	Type (mm)	Price €	Unit/Box
450 0018	H = 28		100/1000



4540

Screed additive in aqueous solution composed of acrylic polymers; reduces hygroscopic withdrawals by increasing the thermal resistance and improving thermal conductivity.

TECHNICAL CHARACTERISTICS

- Dosage: 1 kg of additive x 100 Kg of cement

Code	Type	Price €/kg	Unit/Box (kg)
450 0019	10 Kg ≈ 9,6 l		10/10
450 0017	25 Kg ≈ 24 l		25/25



4508

PE expansion joint, self-adhesive base for smooth and panel with ashlar.

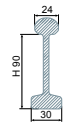

TECHNICAL CHARACTERISTICS

- Height: 90 mm
- Length: 2 m

Code	Type	Price €/m	Unit/Box (m)
450 0023	-		20/180

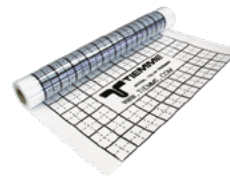

4503

PE sheet with insulation function and moisture barrier.

TECHNICAL CHARACTERISTICS

- Width: 1,2 m
- Length: 100 m
- Thickness: 0,15 mm

Code	Type	Price €/m ²	Unit/Box (m ²)
450 0025	-		120/120



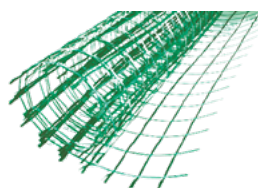

4532

Fiberglass mesh treated for the reinforcement of concrete screeds.

TECHNICAL CHARACTERISTICS

- Mesh size: 40 x 40 mm
- Weight: 130 g/m²

 2 mm wire mesh on request.

Code	Type	Price €/m ²	Unit/Box (m ²)
450 0152	1 m x 50 m		50/400
450 0022	1 m x 100 m		100/400



4539

Corrosion protection of metal parts with universal fungal bactericide for heating and cooling systems.

TECHNICAL CHARACTERISTICS

- Dosage: 1 l of additive x 100 l of circulating water

Code	Type	Price €	Unit/Box
450 0486	1 l		1/12

Specific solution for residential and commercial heating and cooling systems where maximum thermal output is required. The thermo-reflective screen-printed surface of the smooth roll panel offers the possibility of installation at free distance. The coupling between the panels is guaranteed by the lateral overlap of part of the heat-reflecting surface by a double-sided adhesive strip. Maximum protection from thermal bridges.

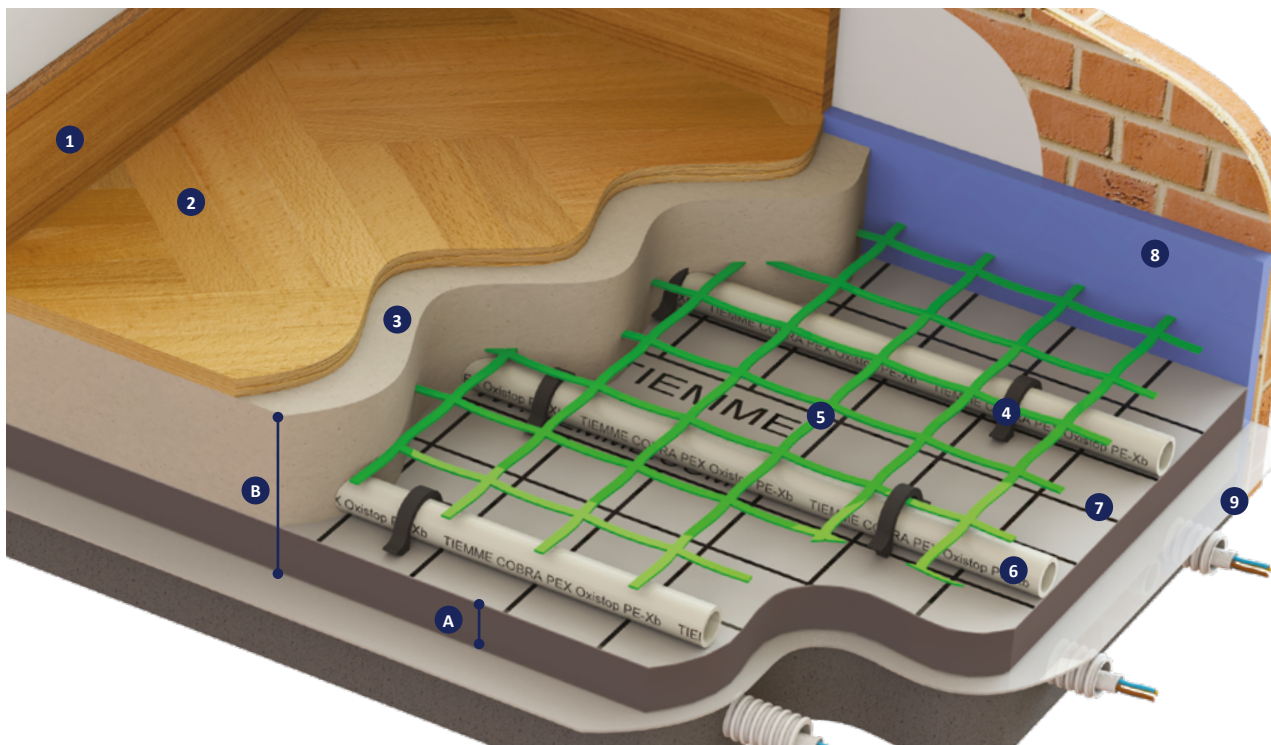

- | | |
|--------------------------|-------------------|
| 1. Skirting | - |
| 2. Coating | - |
| 3. Screed | - |
| 4. Mesh-pipe fixing clip | art. 4521 - 4520G |
| 5. Fiberglass mesh | art. 4532 |
| 6. Pipe | art. 0200B |
| 7. Insulation panel | art. 4505GRF |
| 8. Perimeter strip | art. 4507 |
| 9. PE sheet | art. 4503 |

Code	Dimensions (mm)	
	A	B
450 0558	23	73 ÷ 83
450 0559	30	80 ÷ 90
450 0560	40	90 ÷ 100
450 0555	50	100 ÷ 110
450 0561	60	110 ÷ 120

THICKNESS ACCORDING TO UNI EN 1264

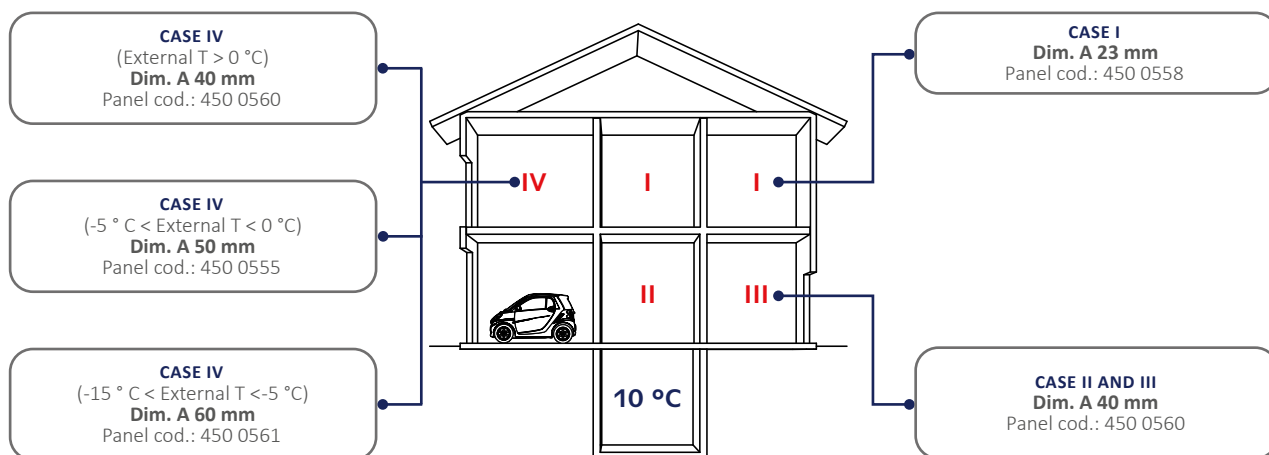

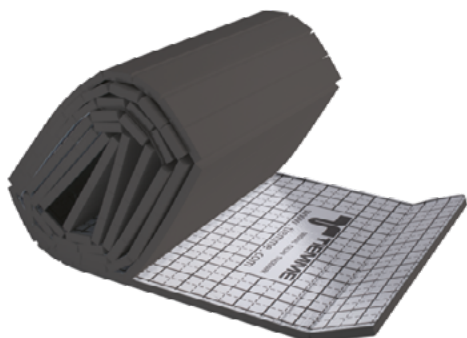

4505GRF

Thermal insulation panel made of EPS sintered expanded polystyrene with graphite, smooth, with protection film and screen-printing 50 mm and multiple pipe distances.

Code	Thickness (mm)	C.R. 10% (kPa)	Price €/m ²	Packaging (m ²)
450 0558	23	150		12/72
450 0559	30	150		10/60
450 0560	40	150		10/40
450 0555	50	150		10/40
450 0561	60	150		8/32

TECHNICAL CHARACTERISTICS

	Codes				
	450 0558	450 0559	450 0560	450 0555	450 0561
Thermal resistance UNI EN 13163 (m ² k/W)	0,76	1,00	1,33	1,66	2,00
Compression resistance to 10% UNI EN 826 (kPa)	150				
Insulation thickness (mm)	23	30	40	50	60
Total thickness (mm)	23	30	40	50	60
Minimum pipe distance (mm)	50				
Thermal conductivity UNI EN 12667 (W/mk)	0,030				
Water absorption UNI EN 12087 (%)	< 3,0				
Reaction to fire EN 13501-1 (Euroclass)	E				
Total roll size (mm)	12000 x 1000	10000 x 1000	10000 x 1000	10000 x 1000	8000 x 1000
Useful roll size (mm)	12000 x 1000	10000 x 1000	10000 x 1000	10000 x 1000	8000 x 1000
Useful roll area (m ²)	12	10	10	10	8
Rolls per package (n)	1				
Roll area per package (m ²)	12	10	10	10	8



0200B

High density COBRAPEX cross-linked polyethylene pipe with EVOH oxygen barrier.

TECHNICAL CHARACTERISTICS

- Maximum operating temperature: 95 °C
- Thermal conductivity: 0,38 W/mk
- Complies with EN ISO 15875-2
- Anti-oxygen barrier in EVOH compliant with DIN 4726
- Composition: PE-Xb

Code	Type	Price €/m	Unit/Box (m)
020 0005	16 x 2,0		120/3240
020 0018	16 x 2,0		200/3600
020 0003	16 x 2,0		300/3600
020 0001	16 x 2,0		600/3000
020 0008	17 x 2,0		120/3240
020 0071	17 x 2,0		200/3200
020 0006	17 x 2,0		300/2700
020 0002	17 x 2,0		600/3000



4507

Perimeter strip in expanded PE with adhesive back and PE sheet to contain mortar.

i With pre-cut H = 100 mm

Code	Type	Price €/m	Unit/Box (m)
450 0443	H 150 x 5 mm		50/250
450 0007	H 150 x 8 mm		25/125



1480P

Plastic 90-fold elbow for the protection and support of the COBRAPEX pipe near the connection to the distribution manifold.

Code	Type	Price €	Unit/Box
034 0077	Pipe Ø 16 - 18		25/500



4521

Clip for fixing the pipe, manual insertion. Made of plastic material complete with anchoring fins.

Code	Type	Price €	Unit/Box
450 0035	H = 45 mm		200/1000
450 0037	H = 50 mm		200/1000

Suitable up to Ø 20 pipe



4520G

Clip for fixing the pipe, with automatic insertion. Made in plastic material is complete with anchor fins. Supplied in strips of 30 pcs. for use with the automatic clip-fixing too.

Code	Type	Price €	Unit/Box
450 0014	H = 39 mm		1050/1050
450 0536	H = 56 mm		690/690

Suitable up to Ø 17 pipe

Suitable up to Ø 20 pipe



4540

Screed additive in aqueous solution composed of acrylic polymers; reduces hygroscopic withdrawals by increasing the thermal resistance and improving thermal conductivity.

TECHNICAL CHARACTERISTICS

- Dosage: 1 kg of additive x 100 Kg of cement

Code	Type	Price €/kg	Unit/Box (kg)
450 0019	10 Kg ≈ 9,6 l		10/10
450 0017	25 Kg ≈ 24 l		25/25



4508

PE expansion joint, self-adhesive base for smooth and panel with ashlar.

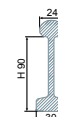

TECHNICAL CHARACTERISTICS

- Height: 90 mm
- Length: 2 m

Code	Type	Price €/m	Unit/Box (m)
450 0023	-		20/180





4503

PE sheet with insulation function and moisture barrier.

TECHNICAL CHARACTERISTICS

- Width: 1,2 m
- Length: 100 m
- Thickness: 0,15 mm

Code	Type	Price €/m ²	Unit/Box (m ²)
450 0025	-		120/120

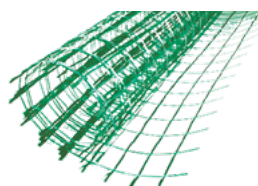

4532

Fiberglass mesh treated for the reinforcement of concrete screeds.

TECHNICAL CHARACTERISTICS

- Mesh size: 40 x 40 mm
- Weight: 130 g/m²

 2 mm wire mesh on request.

Code	Type	Price €/m ²	Unit/Box (m ²)
450 0152	1 m x 50 m		50/400
450 0022	1 m x 100 m		100/400



4539

Corrosion protection of metal parts with universal fungal bactericide for heating and cooling systems.

TECHNICAL CHARACTERISTICS

- Dosage: 1 l of additive x 100 l of circulating water

Code	Type	Price €	Unit/Box
450 0486	1 l		1/12



4520F

Clip fixing tool.

Code	Type	Price €	Unit/Box
450 0034	-		1/1

Specific solution for residential and commercial heating and cooling systems where maximum thermal output is required. The thermo-reflective screen-printed surface of the smooth book panel offers the possibility of installation at free distance. The coupling between the panels is guaranteed by the lateral overlap of part of the heat-reflecting surface by a double-sided adhesive strip. Maximum protection from thermal bridges.

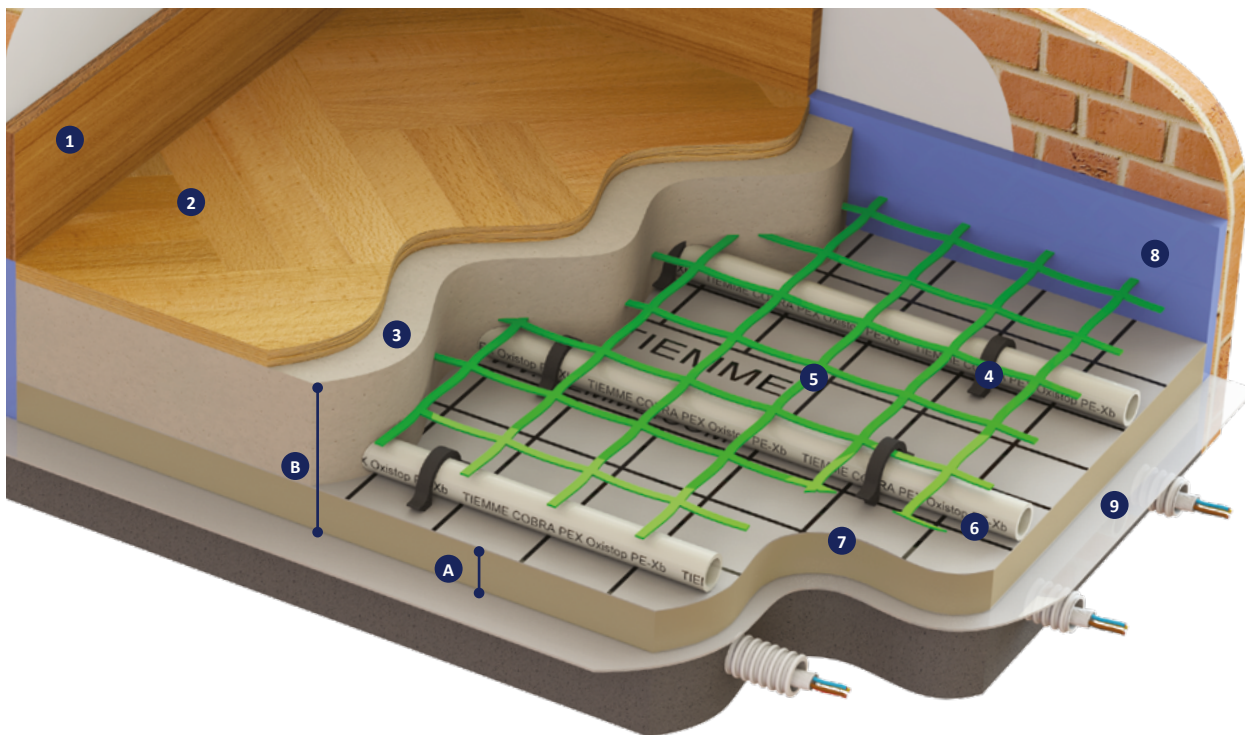

- | | |
|--------------------------|-------------------|
| 1. Skirting | - |
| 2. Coating | - |
| 3. Screed | - |
| 4. Mesh-pipe fixing clip | art. 4521 - 4520G |
| 5. Fiberglass mesh | art. 4532 |
| 6. Pipe | art. 0200B |
| 7. Insulation panel | art. 4505POL |
| 8. Perimeter strip | art. 4507 |
| 9. PE sheet | art. 4503 |

Code	Dimensions (mm)	
	A	B
450 0500	20	70 ÷ 80
450 0501	30	80 ÷ 90
450 0502	40	90 ÷ 100
450 0503	50	100 ÷ 110

THICKNESS ACCORDING TO UNI EN 1264

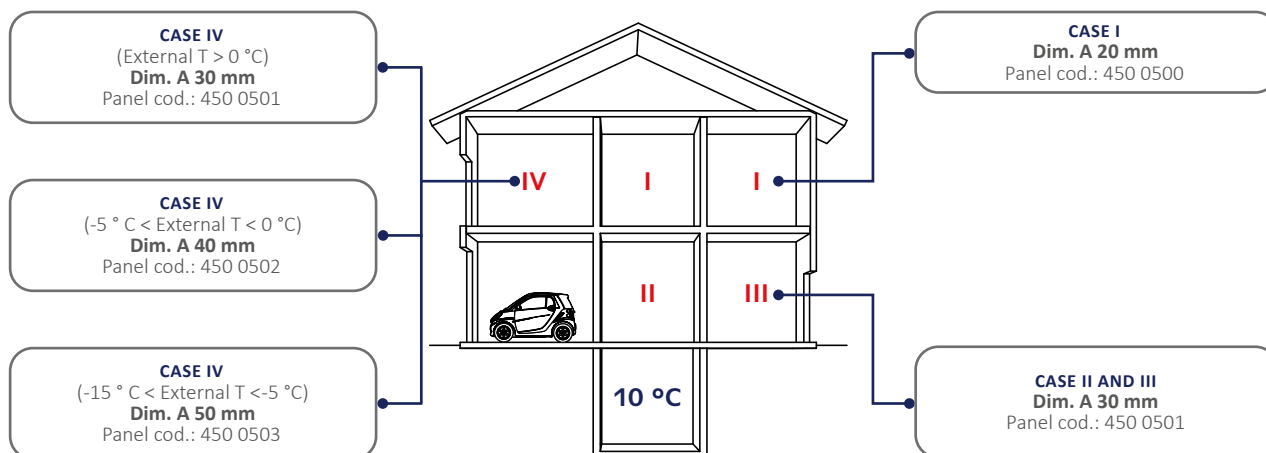



4505POL

Thermal insulation panel in polyiso PIR expanded foam (coupled polyurethane), smooth, with protection film and screen-printing 50 mm and multiple pipe distances. Supplied as book.

Code	Thickness (mm)	C.R. 10% (kPa)	Price €/m ²	Packaging (m ²)	Packaging (no. panels)
450 0500	20	>130		16,8/134,4	7
450 0501	30	>130		12/84	5
450 0502	40	>130		9,6/67,2	4
450 0503	50	>130		9,6/48	4

TECHNICAL CHARACTERISTICS

	Codes			
	450 0500	450 0501	450 0502	450 0503
Thermal resistance UNI EN 13163 (m ² k/W)	0,85	1,30	1,70	2,15
Compression resistance to 10% UNI EN 826 (kPa)	>130			
Insulation thickness (mm)	20	30	40	50
Total thickness (mm)	20	30	40	50
Minimum pipe distance (mm)	50			
Thermal conductivity UNI EN 12667 (W/mk)	0,023			
Density (kg/m ³)	30			
Water absorption UNI EN 12087 (%)	< 1,0			
Reaction to fire EN 13501-1 (Euroclass)	F			
Total panel size (mm)	1000 x (1200 + 1200)			
Useful panel size (aperto) (mm)	1000 x 2400			
Useful panel area(aperto) (m ²)	2,4			
Panels per package (n)	7	5	4	4
Superficie rotoli per Packaging (m ²)	16,8	12	9,6	9,6



0200B

High density COBRAPEX cross-linked polyethylene pipe with EVOH oxygen barrier.

TECHNICAL CHARACTERISTICS

- Maximum operating temperature: 95 °C
- Thermal conductivity: 0,38 W/mk
- Complies with EN ISO 15875-2
- Anti-oxygen barrier in EVOH compliant with DIN 4726
- Composition: PE-Xb

Code	Type	Price €/m	Unit/Box (m)
020 0005	16 x 2,0		120/3240
020 0018	16 x 2,0		200/3600
020 0003	16 x 2,0		300/3600
020 0001	16 x 2,0		600/3000
020 0008	17 x 2,0		120/3240
020 0071	17 x 2,0		200/3200
020 0006	17 x 2,0		300/2700
020 0002	17 x 2,0		600/3000



4507

Perimeter strip in expanded PE with adhesive back and PE sheet to contain mortar.

i With pre-cut H = 100 mm

Code	Type	Price €/m	Unit/Box (m)
450 0443	H 150 x 5 mm		50/250
450 0007	H 150 x 8 mm		25/125



1480P

Plastic 90-fold elbow for the protection and support of the COBRAPEX pipe near the connection to the distribution manifold.

Code	Type	Price €	Unit/Box
034 0077	Pipe Ø 16 - 18		25/500



4521

Clip for fixing the pipe, manual insertion. Made of plastic material complete with anchoring fins.

Code	Type	Price €	Unit/Box
450 0035	H = 45 mm		200/1000
450 0037	H = 50 mm		200/1000

Suitable up to Ø 20 pipe



4520G

Clip for fixing the pipe, with automatic insertion. Made in plastic material is complete with anchor fins. Supplied in strips of 30 pcs. for use with the automatic clip-fixing too.

Code	Type	Price €	Unit/Box
450 0014	H = 39 mm		1050/1050
450 0536	H = 56 mm		690/690

Suitable up to Ø 17 pipe

Suitable up to Ø 20 pipe



4540

Screed additive in aqueous solution composed of acrylic polymers; reduces hygroscopic withdrawals by increasing the thermal resistance and improving thermal conductivity.

TECHNICAL CHARACTERISTICS

- Dosage: 1 kg of additive x 100 Kg of cement

Code	Type	Price €/kg	Unit/Box (kg)
450 0019	10 Kg ≈ 9,6 l		10/10
450 0017	25 Kg ≈ 24 l		25/25



4508

PE expansion joint, self-adhesive base for smooth and panel with ashlar.

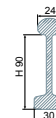

TECHNICAL CHARACTERISTICS

- Height: 90 mm
- Length: 2 m

Code	Type	Price €/m	Unit/Box (m)
450 0023	-		20/180





4503

PE sheet with insulation function and moisture barrier.

TECHNICAL CHARACTERISTICS

- Width: 1,2 m
- Length: 100 m
- Thickness: 0,15 mm

Code	Type	Price €/m ²	Unit/Box (m ²)
450 0025	-		120/120

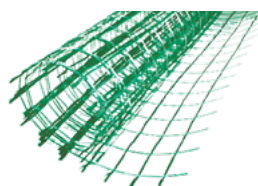

4532

Fiberglass mesh treated for the reinforcement of concrete screeds.

TECHNICAL CHARACTERISTICS

- Mesh size: 40 x 40 mm
- Weight: 130 g/m²

 2 mm wire mesh on request.

Code	Type	Price €/m ²	Unit/Box (m ²)
450 0152	1 m x 50 m		50/400
450 0022	1 m x 100 m		100/400



4539

Corrosion protection of metal parts with universal fungal bactericide for heating and cooling systems.

TECHNICAL CHARACTERISTICS

- Dosage: 1 l of additive x 100 l of circulating water

Code	Type	Price €	Unit/Box
450 0486	1 l		1/12



4520F

Clip fixing tool.

Code	Type	Price €	Unit/Box
450 0034	-		1/1

One of the factors linked to the radiant system and connected to domestic comfort is acoustic well-being. Acoustic well-being is defined as the condition in which a subject is not disturbed by extraneous sounds and does not suffer damage to the auditory apparatus caused by more or less prolonged exposure to sources of noise. In particular, there are two main sources of noise disturbance in a building: external sources and internal sources.

The **external sources** are essentially vehicle traffic and the possible presence of industrial production activities in the vicinity of the building. The noise produced by external sources spreads by air and then penetrates the building through its shell.

The technological and constructive characteristics of the facades are decisive in offering greater or lesser resistance to the diffusion towards the inside of the sound waves coming from the outside. In this sense, openings such as windows or ventilation grilles represent the weak points of the building in the defence against noise.

The **internal noise sources**, which may relate specifically to the environment being studied or other areas of the same building, are the installations (lifts, hoists, plumbing, etc.), household appliances, radio-equipment, television, voices, shouts and movements of the occupants of the building. In this case the propagation occurs both by air and through the solid parts of the construction.

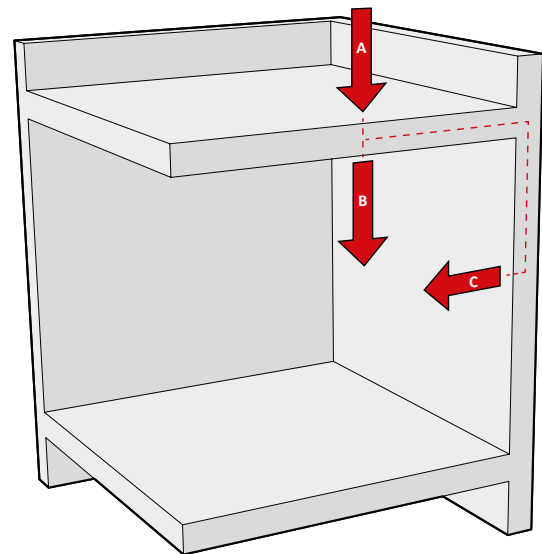

- A. Footfall noise
- B. Direct transmission
- C. Lateral transmission

Within the Tiemme product range there are panels, which have sound absorption characteristics with important values (up to 28 dB) and which can help the customer to meet legislative requirements.

TIEMME'S SOLUTION

SILENTO

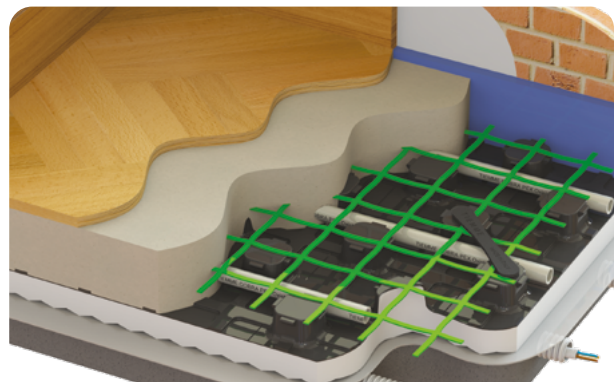

The construction of a radiant system clearly impacts on the structural aspect of the building for which we fall into the category "internal noise sources", more specifically in the "footfall noise".

The law (D.P.C.M: 5/12/97) defines various aspects of the passive acoustic requirements of the building and two of these interest us in particular:

- **the limit of footfall noise within a residential building shall be less than 63 dB;**
- **This value must be measured on site (this means that within the system "source of noise-absorbing material-final result" also comes into play laying).**

However, in order to design a building, we need rules that precede the realization itself. The European Standard EN 12354-2 proposes two calculation methods defined respectively "detailed model" and "simplified model". Clearly the results of the calculations do not take into account any material defects or errors in the installation (not quantifiable). In the case of residential buildings with brick and/or concrete masonry or floating floor it is possible to apply the simplified model.

The expression of the particular noise assessment index is as follows:

$$L_{n,w} = L_{n,w,eq} + K - \Delta L_w$$

where:

- $L_{n,w,eq}$: This is the standard footfall noise rating of the floor without sound insulation (bare floor) and is a value calculated as a function of the floor mass per unit area (m^2).
- K : This is the corrective factor for the lateral transmission of footfall noise as a function of the floor mass and the average mass per area of the disturbed room walls (m^2).
- ΔL_w : This is the evaluation index of footfall noise reduction and is calculated from the mass per unit of floating floor area (m^2) and the dynamic stiffness of the sound absorbing carpet.
- This is where the "sound insulation" factor of the radiant panel and its characteristics of absorption of footfall noise comes into play.

DIAGRAM

In the diagram below we report the evaluation index of the attenuation of the sound pressure level of footfall for floating floors in cement mortar or calcium sulphate according to UNI EN 12354-2.

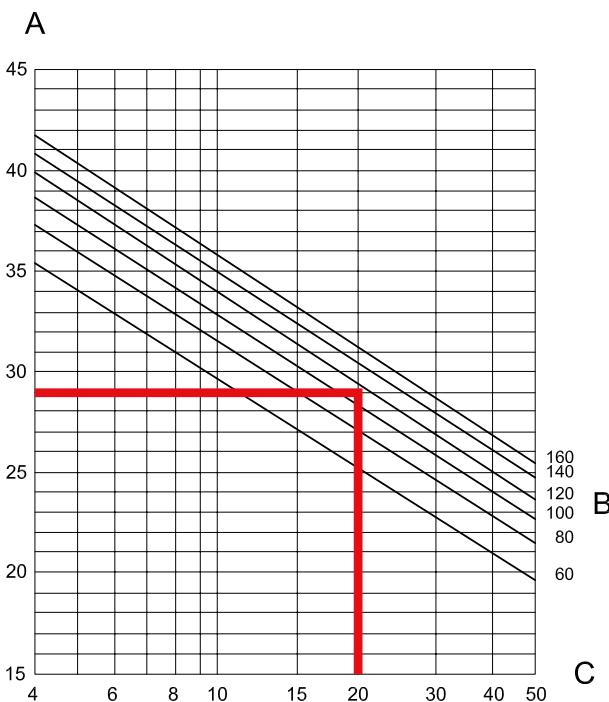

where:

- **A:** Rating index of the sound pressure level of attenuation
- ΔL_w (dB)
- **B:** Mass per unit of floating floor area (kg/m^2)
- **C:** Dynamic stiffness per unit area, s' , of the resilient layer (MN/m^3)

Silento is an innovative system whose panel has been designed to thermally insulate the floor and retain the pipe but above all to effectively reduce the noise of foot traffic.

This was achieved using EPS-T, a high-performance material obtained through an advanced industrial process and further enhanced by a particular geometric shape of the bottom of the panel. Finally, to give the EPS-T additional characteristics of solidity and reliability, it has been coupled to a thermoformed able to withstand high loads both during installation and during work.

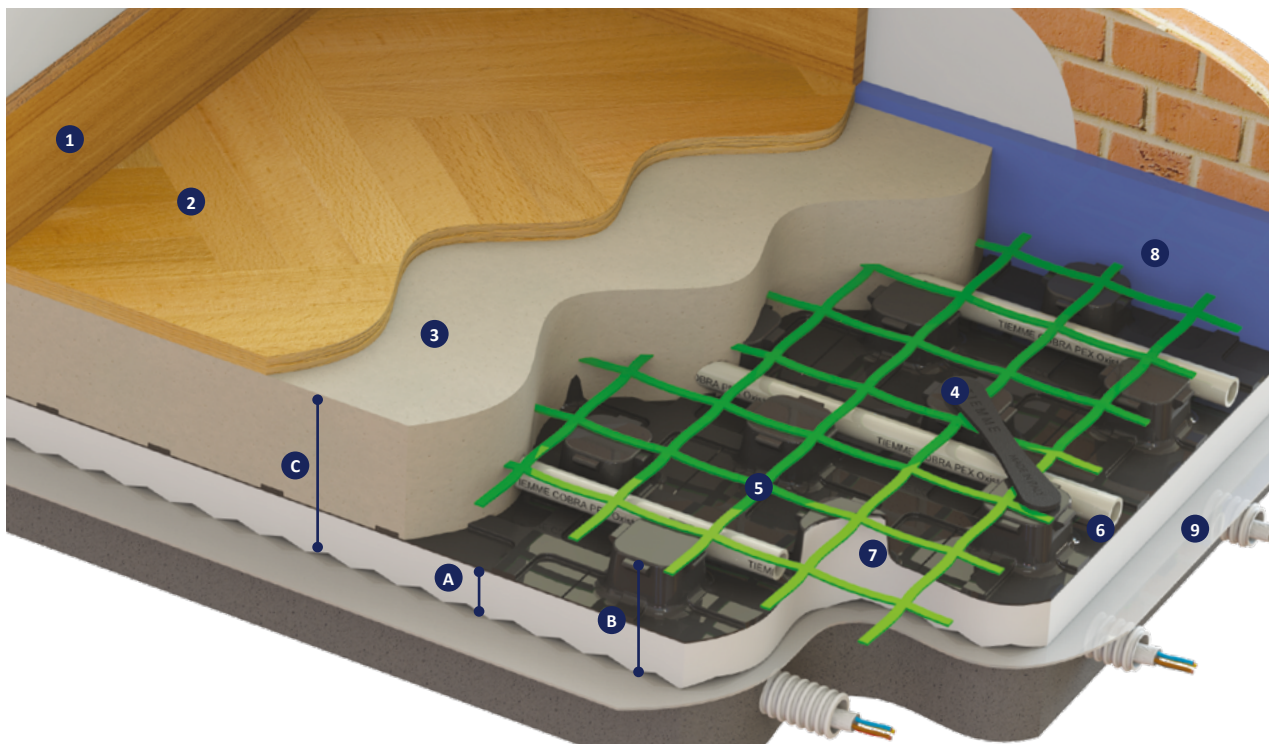

- 1. Skirting -
- 2. Coating -
- 3. Screed -
- 4. Mesh fixing clip art. 4527
- 5. Fiberglass mesh art. 4532
- 6. Pipe art. 0200B
- 7. Insulation panel art. 4502SIL
- 8. Perimeter strip art. 4513
- 9. PE sheet art. 4503

Code	Dimensions (mm)		
	A	B	C
450 0313	30	52	80 ÷ 90

THICKNESS ACCORDING TO UNI EN 1264*

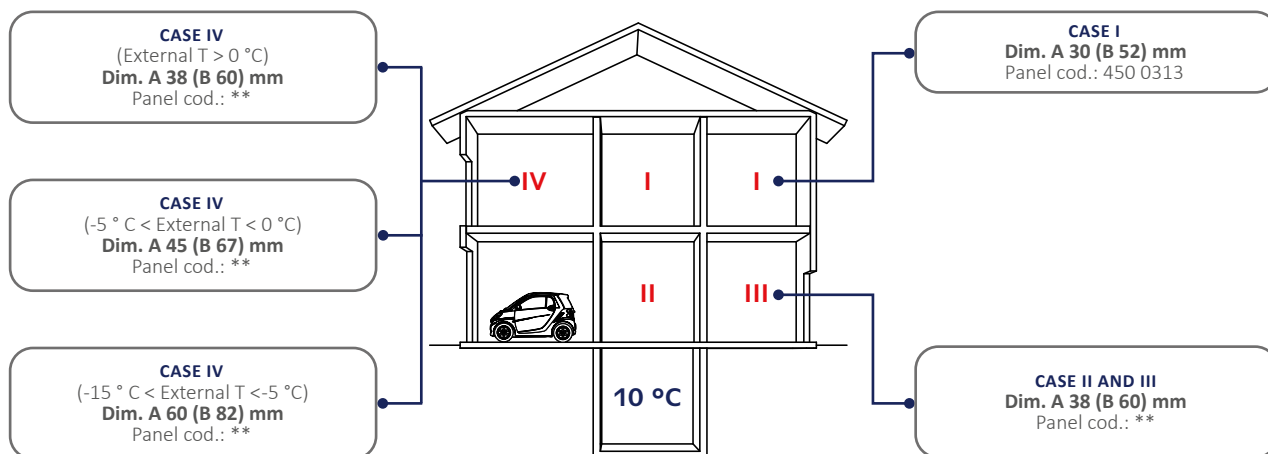

* To obtain the thermal resistance value required by UNI EN 1264, an insulating mat can be added.

** Panel values for "Techno Graphite CAM" 4528PANGRF coupled with acoustic insulation 4511



PRICE LIST



4502SIL

EPS-T stretch expanded polystyrene thermal insulation panel with embossed ashlars for pipe clamping. 50 mm and multiples pipe distances

Code	Insulation thickness (mm)	Price €/m ²	Packaging (m ²)	Packaging (no. panels)
450 0313	30		11,20/56	10

TECHNICAL CHARACTERISTICS

	Codes
	450 0313
Improvement of noise abatement (db)	28
Thermal resistance UNI EN 13163 (m ² k/W)	0,75
Dynamic stiffness s' (MN/m ³) UNI EN 29052-1, screed area mass per unit 110 (kg/m ²)	20
Livello di comprimibilità sotto compressione 2 mm UNI EN 12431	CP2
Insulation thickness (mm)	30
Total thickness (mm)	52
Total thickness equivalente UNI EN 1264/3 (mm)	34
Thickness of the covering thermoformed sheath (mm)	0,8
Minimum pipe distance (mm)	50
Thermal conductivity UNI EN 12667 (W/mk)	0,040
Reaction to fire EN 13501-1 (Euroclass)	E
Total panel size (mm)	1450 x 850
Useful panel size (mm)	1400 x 800
Panel area (m ²)	1,12
Panels per package (n)	10
Panel area per package (m ²)	11,20



0200B

High density COBRAPEX cross-linked polyethylene pipe with EVOH oxygen barrier.

TECHNICAL CHARACTERISTICS

- Maximum operating temperature: 95 °C
- Thermal conductivity: 0,38 W/mk
- Complies with EN ISO 15875-2
- Anti-oxygen barrier in EVOH compliant with DIN 4726
- Composition: PE-Xb

Code	Type	Price €/m	Unit/Box (m)
020 0005	16 x 2,0		120/3240
020 0018	16 x 2,0		200/3600
020 0003	16 x 2,0		300/3600
020 0001	16 x 2,0		600/3000
020 0008	17 x 2,0		120/3240
020 0071	17 x 2,0		200/3200
020 0006	17 x 2,0		300/2700
020 0002	17 x 2,0		600/3000



4511

Acoustic insulation for floor sound insulation.

TECHNICAL CHARACTERISTICS

- Width: 1,04 m (4 cm banda adesiva)
- Length: 5 m
- Thickness: 5 mm

 Match panel 4528PANGRF Techno Graphite CAM

Code	Type	Price €/m ²	Unit/Box (m ²)
450 0317	-		5/160



4513

Perimeter strip for sound insulation, "L" preformed, adhesive on both external sides.

Code	Type	Price €/m	Unit/Box (m)
450 0389	H 150 x 6 mm		50/200



4507

Perimeter strip in expanded PE with adhesive back and PE sheet to contain mortar.

 With pre-cut H = 100 mm

Code	Type	Price €/m	Unit/Box (m)
450 0443	H 150 x 5 mm		50/250
450 0007	H 150 x 8 mm		25/125



1480P

Plastic 90-fold elbow for the protection and support of the COBRAPEX pipe near the connection to the distribution manifold.

Code	Type	Price €	Unit/Box
034 0077	Pipe Ø 16 - 18		25/500



4527

Clip for fixing the mesh. Made of plastic material and complete of anchoring fins.

Code	Type	Price €	Unit/Box
450 0018	H = 28 mm		100/1000



4540

Screed additive in aqueous solution composed of acrylic polymers; reduces hygroscopic withdrawals by increasing the thermal resistance and improving thermal conductivity.

TECHNICAL CHARACTERISTICS

- Dosage: 1 kg of additive x 100 Kg of cement

Code	Type	Price €/kg	Unit/Box (kg)
450 0019	10 Kg ≈ 9,6 l		10/10
450 0017	25 Kg ≈ 24 l		25/25





4508

PE expansion joint, self-adhesive base for smooth and panel with ashlar.

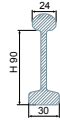

TECHNICAL CHARACTERISTICS

- Height: 90 mm
- Length: 2 m

Code	Type	Price €/m	Unit/Box (m)
450 0023	-		20/180

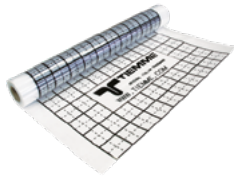

4503

PE sheet with insulation function and moisture barrier.

TECHNICAL CHARACTERISTICS

- Width: 1,2 m
- Length: 100 m
- Thickness: 0,15 mm

Code	Type	Price €/m ²	Unit/Box (m ²)
450 0025	-		120/120

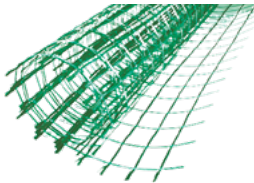

4532

Fiberglass mesh treated for the reinforcement of concrete screeds.

TECHNICAL CHARACTERISTICS

- Mesh size: 40 x 40 mm
- Weight: 130 g/m²

i 2 mm wire mesh on request.

Code	Type	Price €/m ²	Unit/Box (m ²)
450 0152	1 m x 50 m		50/400
450 0022	1 m x 100 m		100/400



4539

Corrosion protection of metal parts with universal fungal bactericide for heating and cooling systems.

TECHNICAL CHARACTERISTICS

- Dosage: 1 l of additive x 100 l of circulating water

Code	Type	Price €	Unit/Box
450 0486	1 l		1/12

02 CEILING/WALL RADIANT SYSTEMS

02A Ceiling radiant systems

Ceiling radiant systems - introduction 64

CEILING HOME SMART 66

02B Wall radiant systems

Wall radiant systems - introduction 74

WALL 75

02C Ceiling radiant systems for the tertiary sector

Ceiling radiant systems for the tertiary sector - introduction 78

CEILING OFFICE 79

The ceiling heating system diffuses the heat in all the rooms of the house through a principle of radiation exchange between hot and cold surfaces.

WHAT IS IT?

Radiation is that phenomenon that occurs frequently in nature when a surface absorbs the heat contained or generated by a surface that has a relatively higher surface temperature.

Similarly, the walls of the room in which the ceiling heating system is located represent the cold surface and accumulate the heat generated by the false ceiling, distributing it in turn in the room and heating it.



NO NEED FOR MASONRY

Ceiling heating is an economical solution because the installation of the radiant panels that make up the system does not require demolition or other masonry works.

HOMOGENEITY OF HEAT

In the ceiling heating the heat diffusion is homogeneous and allows a fair exchange between the environment and the radiant system. This ensures a heating without temperature changes.

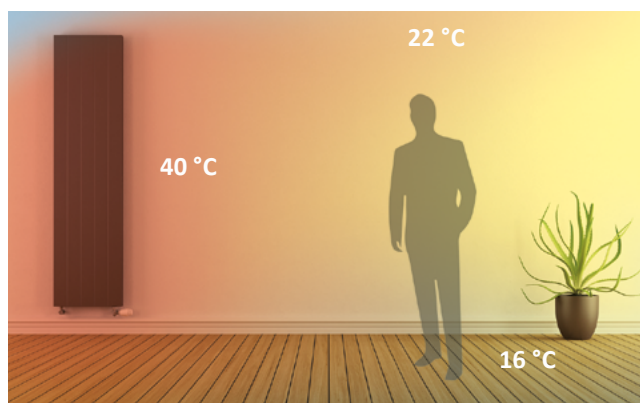

Radiator heating

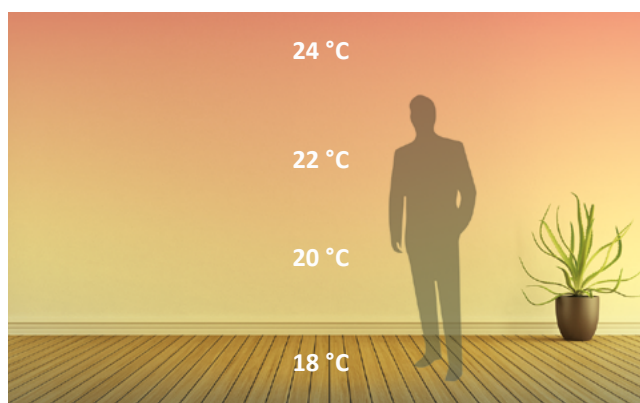

Ceiling heating

EASE OF INSTALLATION AND VERSATILITY OF USE

The radiant panels are already composed, pre-assembled and are ideal for both the production of heat during the cold period and for cooling in the hottest periods of the year.

SPACE SAVING TO A MINIMUM

The radiant ceiling panels are an invisible heating system with no space requirement. Their thickness is less than 50 mm and the type of installation does not bind in any way the environments in which they are installed.

WIDE ARCHITECTURAL COMPATIBILITY

The ceiling heating system has high qualities of modularity and perfect architectonic integration allowing to adapt the panels to any type of ceiling.

REDUCTION OF HUMIDITY, MOULD, AND BAD ODOURS

The diffusion of heat through heat exchange allows a reduction of humidity, mould, and bad odours. An even more appreciable feature in the northern part of the dwelling where the formation of unwanted microorganisms is more frequent.

Ceiling Home Smart is the new system solution for the development of radiant ceiling heating and/or cooling systems.

The new panel has the characteristic of being divided into 3 sub-modules and is able to adapt to any room in which it will be installed.

The sheet with which Ceiling Home Smart has been made is of a special type with increased core density (type D), made with plaster admixed with glass fibres and wood fibres that give a high degree of surface hardness and mechanical strength (type I-R). The sheet is also characterized by reduced water absorption (type H1), with excellent tightness in the presence of high humidity levels, and a reduced value of vapour permeability (type E); This peculiarity makes the Tiemme modular panel suitable for any type of environment, including bathrooms, laundries, kitchens, etc...

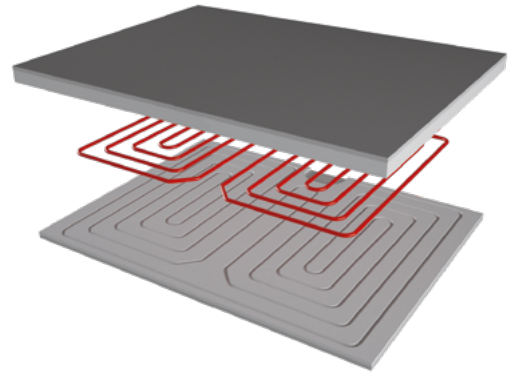

Ceiling Home Smart presents 3 independent circuits, milled inside the plasterboard panel, with a 50 mm pipe distance, made with \varnothing 12 x 1.1 mm pipe. The complete circuit board is coated with a 30 mm thick EPS sheet.

The size of the panel is 1200 x 2000 mm, the surface of which is 2.4 m².

On the lower edge of the sheet there is the screen-printing of the radiant circuit and the cutting line of the panel in the sub-modules:

- 1200 x 500 mm (no. 2) + 1200 x 1000 mm (no. 1)
- or
- 1200 x 1500 mm (no. 1) + 1200 x 500 mm (no. 1)
- or
- 1200 x 1000 mm (no. 2)

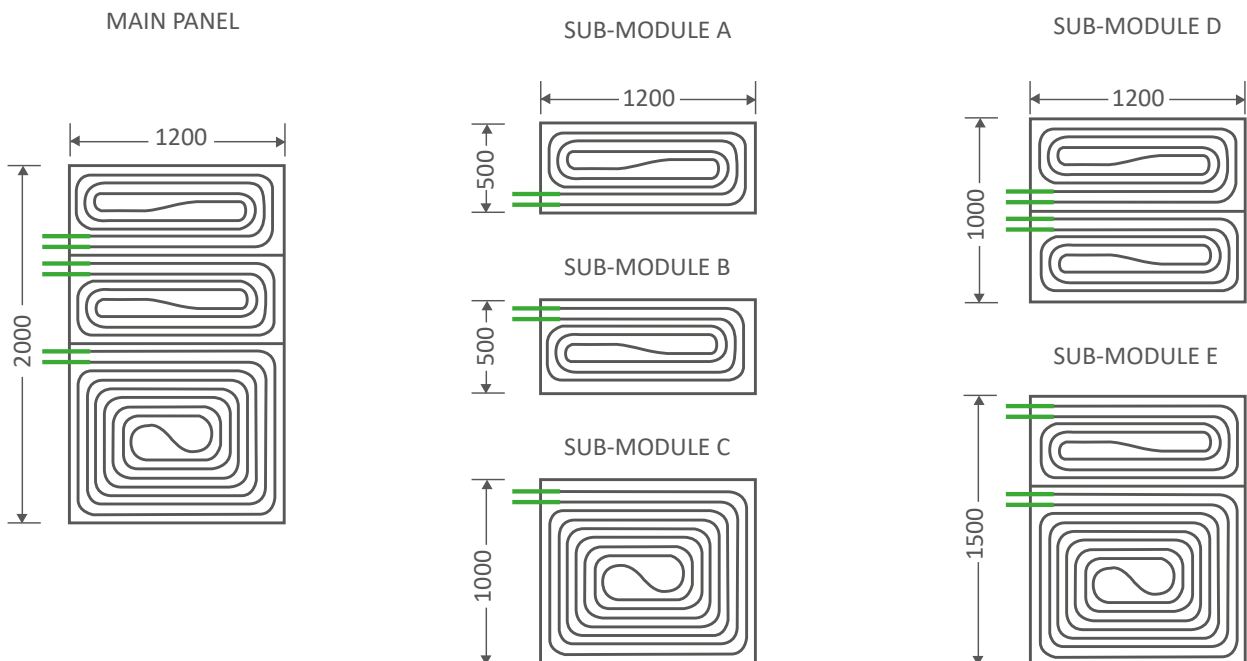

PRICE LIST

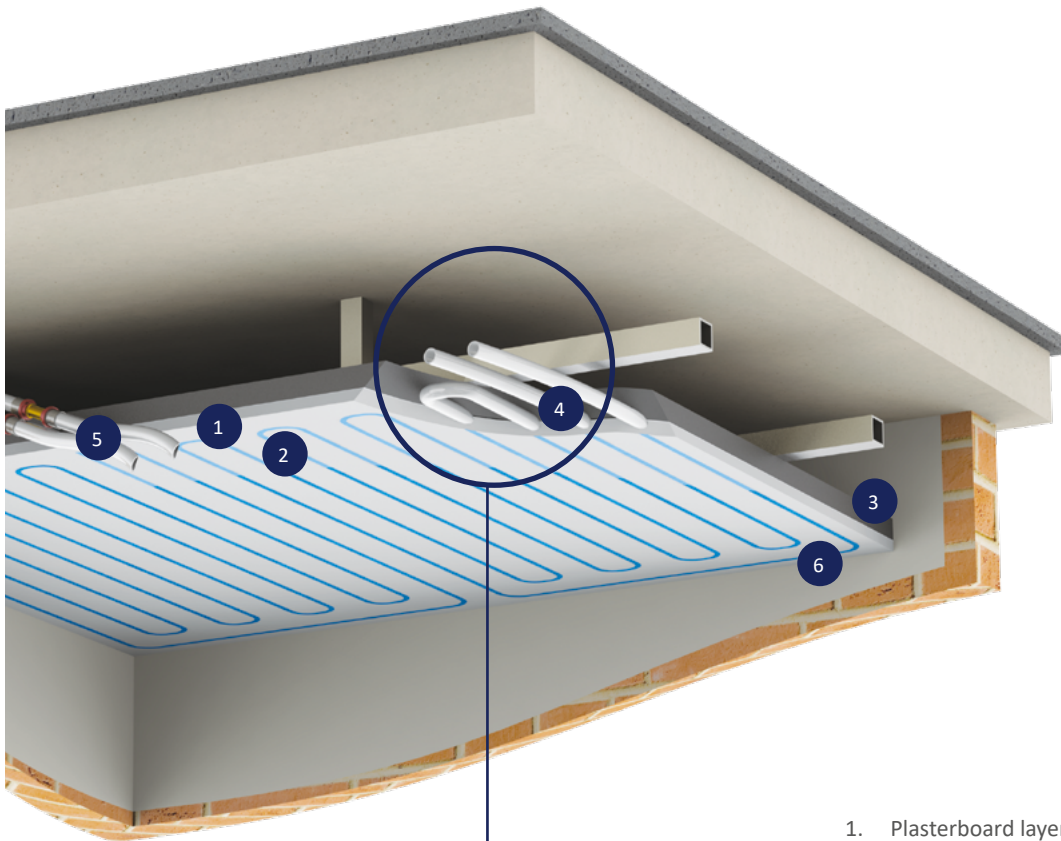

1. Plasterboard layer
2. Coil
3. Insulation layer in polystyrene
4. \varnothing 12 x 1.1 mm PE-X pipe
5. \varnothing 20 x 2.0 mm Multilayer pipe (risers)
6. Radiant panel

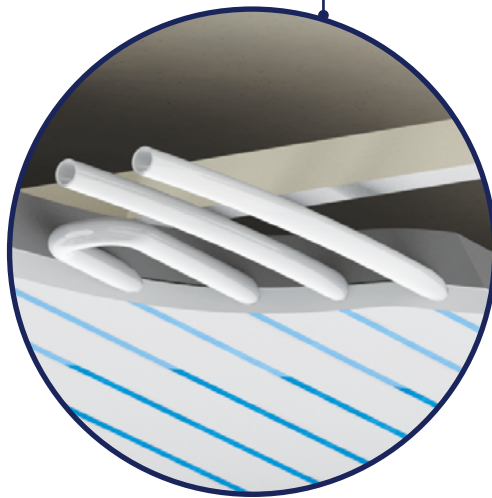

STRENGTHS

- Low thermal inertia
- suitable for new buildings and renovations
- simple and quick to install
- high versatility
- modular panel
- moisture-resistant
- neutralizes the formaldehyde in the air

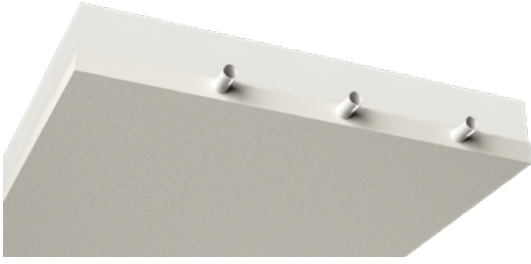

RU50

Active wall/ceiling radiant panel for summer cooling systems and low temperature winter heating.

DESCRIPTION

Composed of:

- Plasterboard sheet 15 mm thk.
- Insulating sheet in sintered expanded polystyrene 30 mm thk., thermal conductivity 0,034 W/mk
- No.3 radiant coils made with \varnothing 12x1.1 PE-X pipe mm conforming to EN ISO 15875-2 with anti-oxygen barrier conforming to DIN 4726

TECHNICAL CHARACTERISTICS

- Pipe distance 50 mm
- Total thickness 45 mm
- Adductions with \varnothing 20x2 mm multilayer pipe
- Drawing of the coil on the plasterboard surface for a secure fixing

Code	Type	Dimensions (mm)	Price €/m ²	Unit/Box (m ²)
450 0701	-	2000 x 1200		2,4/ 2,4



RNU

Plasterboard panel for infill of radiant ceiling and wall systems with polystyrene insulation layer

DESCRIPTION:

Composed of:

- Plasterboard sheet 15 mm thk.,
- Insulating sheet in expanded polystyrene 30 mm thk., thermal conductivity 0.034 W/mk

TECHNICAL CHARACTERISTICS:

- Total thickness: 45 mm
- Weight: 16,5 kg/m²

Code	Dimensions	Price €/m ²	Unit/Box (m ²)
450 0702	1200 x 2000 mm		2,4/2,4



Characteristic	DESCRIPTION
Insulating thickness	30 mm
Plasterboard thickness	15 mm
Total thickness	45 mm
Radiant circuits pipe type	PE-X Ø 12 x 1,1 mm
Plasterboard sheet	Plaster layer with glass and wood fibres
Fire resistance EN 13501-1 (Euroclass)	E
Insulating type	EPS 150, white
Insulation thermal conductivity UNI EN 12667	0,034 W/mK
Pipe distance	50 mm
Allowable temperature range of the thermal energy carrier fluid	8-50 °C
Maximum allowable temperature	60 °C
Minimum operating temperature	8 °C
Maximum allowable pressure	6 bar
Maximum test pressure circuit	4 bar
Ø 12 x 1.1 mm elementary circuit pressure drop	4 kPa
Fluid velocity	12 m/min.
Elementary circuit water volume	1,40 l + 0,70 l + 0,70 l
Elementary circuit length	19,3 m + 9 m + 9 m
Active / passive panel weight	16,5 kg/m ²

HEATING



Curves of performance certificates according to prEN 14037-5:2011 in heating.

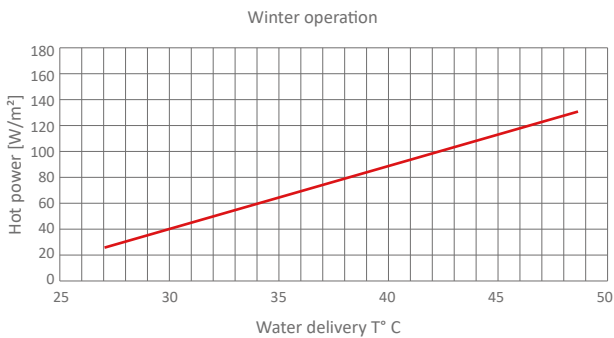

COOLING



Curves of the efficiency certificates according to UNI EN 14240:2005 in cooling.

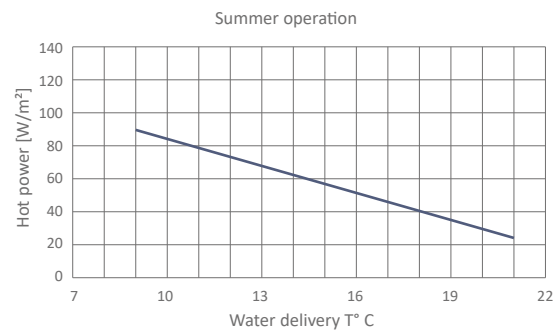

The increasing demand for such systems is able to guarantee the comfort throughout the year and the healthiness of the premises, the experience gained in the field and the continuous technological research have led Tiemme to develop alongside the traditional Ceiling Home Smart system some innovative solutions able to guarantee an even more practical and fast installation, high performance and greater versatility of use even in structures where there are specific constraints of reaction to fire.

TIEMME'S SOLUTIONS

CEILING HOME SMART FIRE

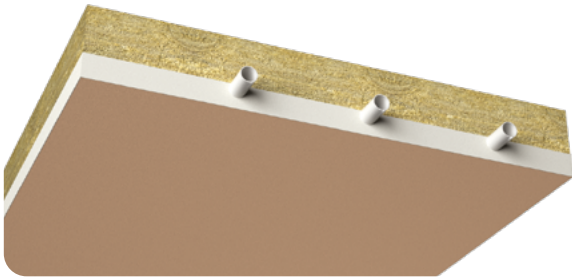

CEILING HOME SMART SILENT

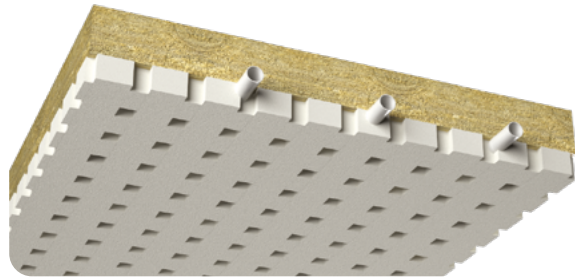

CEILING HOME SMART ALU FIRE

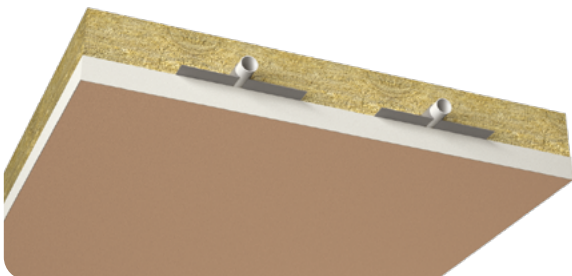

CEILING HOME SMART ALU SILENT

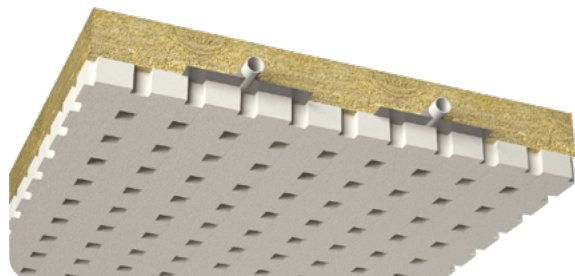

CEILING HOME (PASSO DI POSA 30 MM)

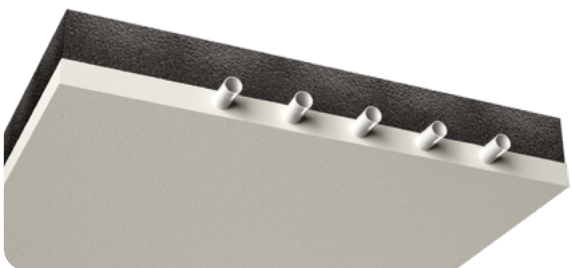

FOR AVAILABILITY AND ACCESSORIES CONTACT
THE SYSTEMS OFFICE



EXAMPLE OF HYDRAULIC CONNECTIONS

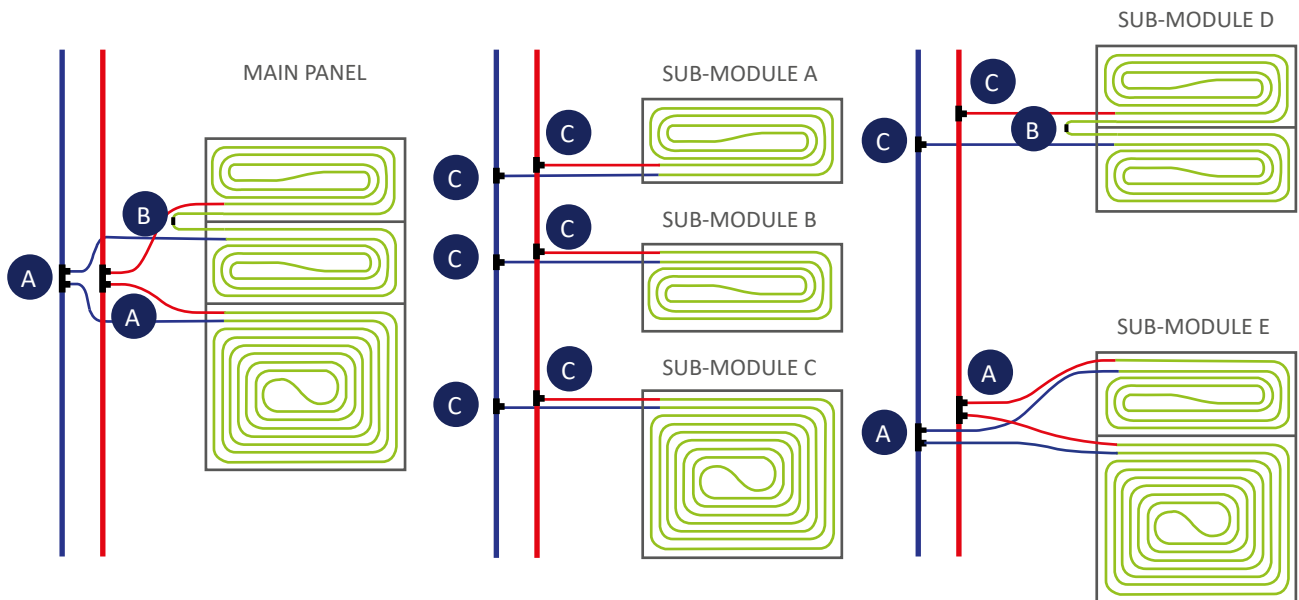

For the realization of the connections should be used:
 - Multilayer main supply network DN20 tongs Cod. 159 0027
 - Terminal pipe of panel PEX DN12 tongs Cod. 159 0128



3670
Y filter for the collection of impurities

TECHNICAL CHARACTERISTICS:

- Filtration: 350 µm to 600 µm depending on diameter
- Body material: brass C W 617N
- Max working pressure: 20 bar up to 2"
- Max operating temperature: 100°C
- Connection threads: female/female ISO 228

Code	Type	Price €	Unit/Box
367 0001	3/4"		18/54
367 0002	1"		10/30
367 0005	1"1/4		4/16
367 0009	1"1/2		3/12
367 0004	2"		2/8

Plug with hole for sealing



5570
Automatic deaerator of bubbles or micro-air bubbles with insulation.

TECHNICAL CHARACTERISTICS

- Body: brass
- Internal elements: stainless steel
- Insulation: EPP
- Operating temperature range: - 10 °C ÷ + 110 °C
- Maximum working pressure: 10 bar

Code	Type	Price €	Unit/Box
556 0001	3/4"		1/4
556 0002	1"		1/4
556 0003	1"1/4		1/4
556 0004	1"1/2		1/3
556 0395	2"		1/4

Without insulation



4539
Corrosion protection of metal parts with universal fungal bactericide for heating and cooling systems.

TECHNICAL CHARACTERISTICS

- Dosage: 1 l of additive x 100 l of circulating water

Code	Type	Price €	Unit/Box
450 0486	1 l		1/12



1657
Brass T Press distributor fitting

i Ø 20 connection for multilayer pipe

i Fitting suitable for the construction of risers

Code	Type	Price €	Unit/Box
165 0005	20 x 20 x 20		5/50



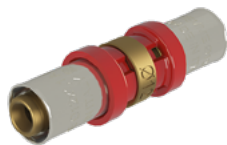

5581
Double straight brass press fitting

i Ø 12 connection for PEX pipe

Code	Type	Price €	Unit/Box
556 0388	12 x 12		10/100



5581T
Brass T Press distributor fitting

i Ø 12 connection for PEX pipe
Ø 20 connection for multilayer pipe

Code	Type	Price €	Unit/Box
556 0386	20 x 12 x 20		5/50



5581C
Double line brass press T distributor fitting

i Ø 12 connection for PEX pipe
Ø 20 connection for multilayer pipe

Code	Type	Price €	Unit/Box
556 0387	20 x 12 x 12 x 20		5/50



1677
Brass press end fitting

i Ø 20 connection for multilayer pipe

Code	Type	Price €	Unit/Box
165 0216	20		10/100



1695TM01
TIEMME battery-powered press tool standard version for pipe from Ø 14 to Ø 90 inclusive

i The press tool is supplied in a case complete with: rechargeable battery Li-Ion 18Vdc - 2,0 Ah; battery charger; Tongs set (if provided) Ø 16, 20, 26

Code	Set pinze	Price €	Unit/Box
159 0085	not included		1/1



1695TM03
TIEMME battery-operated press tool MINI version for pipe Ø 14 to 32 included

i The press tool is supplied in a case complete with: Li-Ion 12Vdc - 2,0 Ah rechargeable battery; battery charger; Tongs set (if provided) Ø 16, 20, 26

Code	Set pinze	Price €	Unit/Box
159 0089	not included		1/1



1681
TH profile tongs - customized TIEMME

Code	Type	Price €	Unit/Box
159 0149	12		1/1



1681MINI
TH profile tongs - customized TIEMME for MINI press

Code	Type	Price €	Unit/Box
159 0128	12		1/1
159 0027	20		1/1

i For the complete range of equipment see the catalogue Hydraulic components.

Wall radiant systems are the ideal solution for all those situations where the floor installation is not feasible or if feasible, does not ensure a sufficiently large radiant surface and there is a need to supplement with an additional heating surface

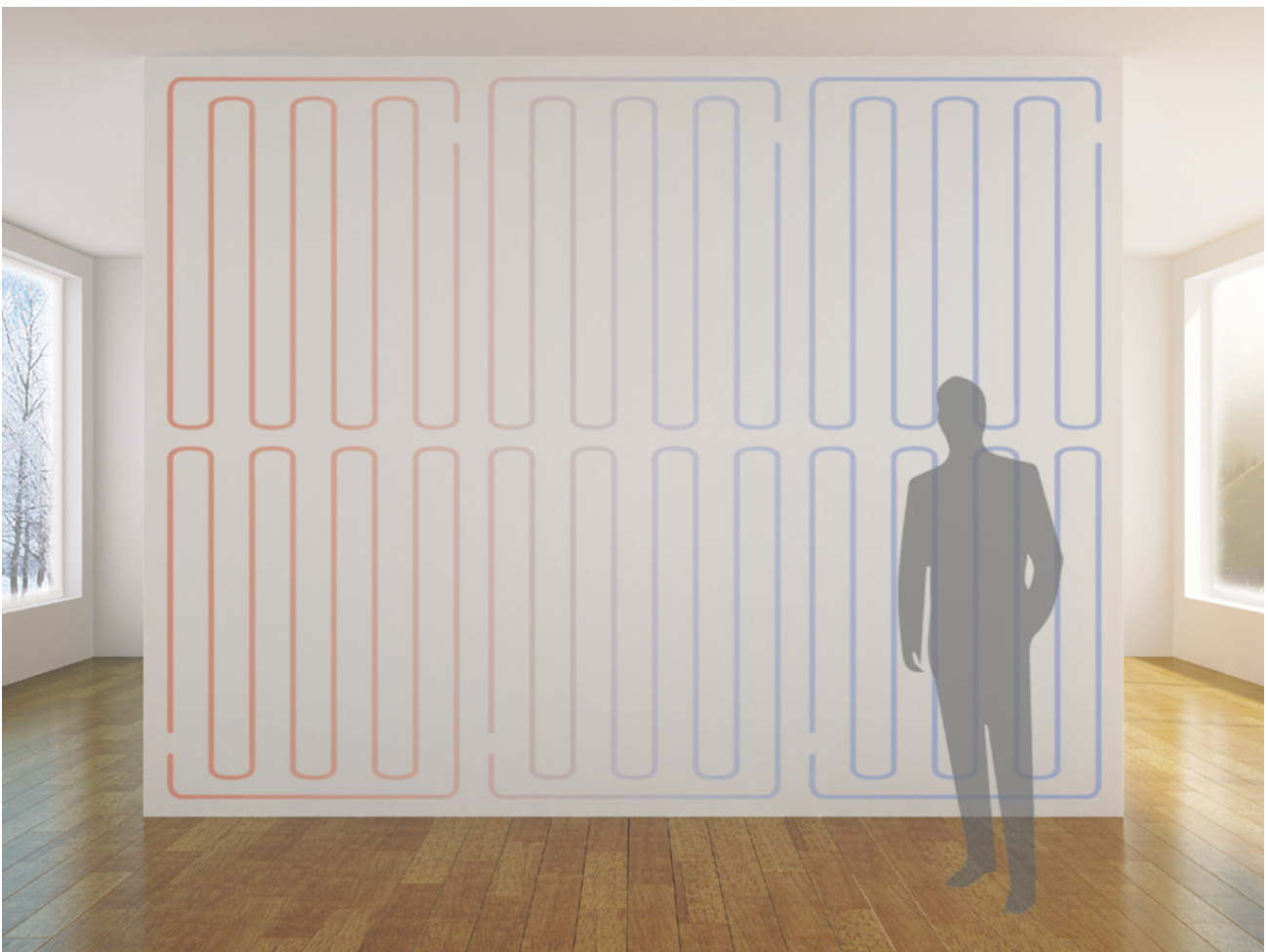

02_B WALL

Introduction

Specific solution for residential and commercial heating and cooling systems where it is not possible to install the radiant system on the ground or where the ground system needs integration.

The WALL system is based on modular and pre-assembled radiant panels connected through practical fittings.

All panels are equipped with expanded polystyrene insulation and additional space is available for additional insulation behind the plasterboard.

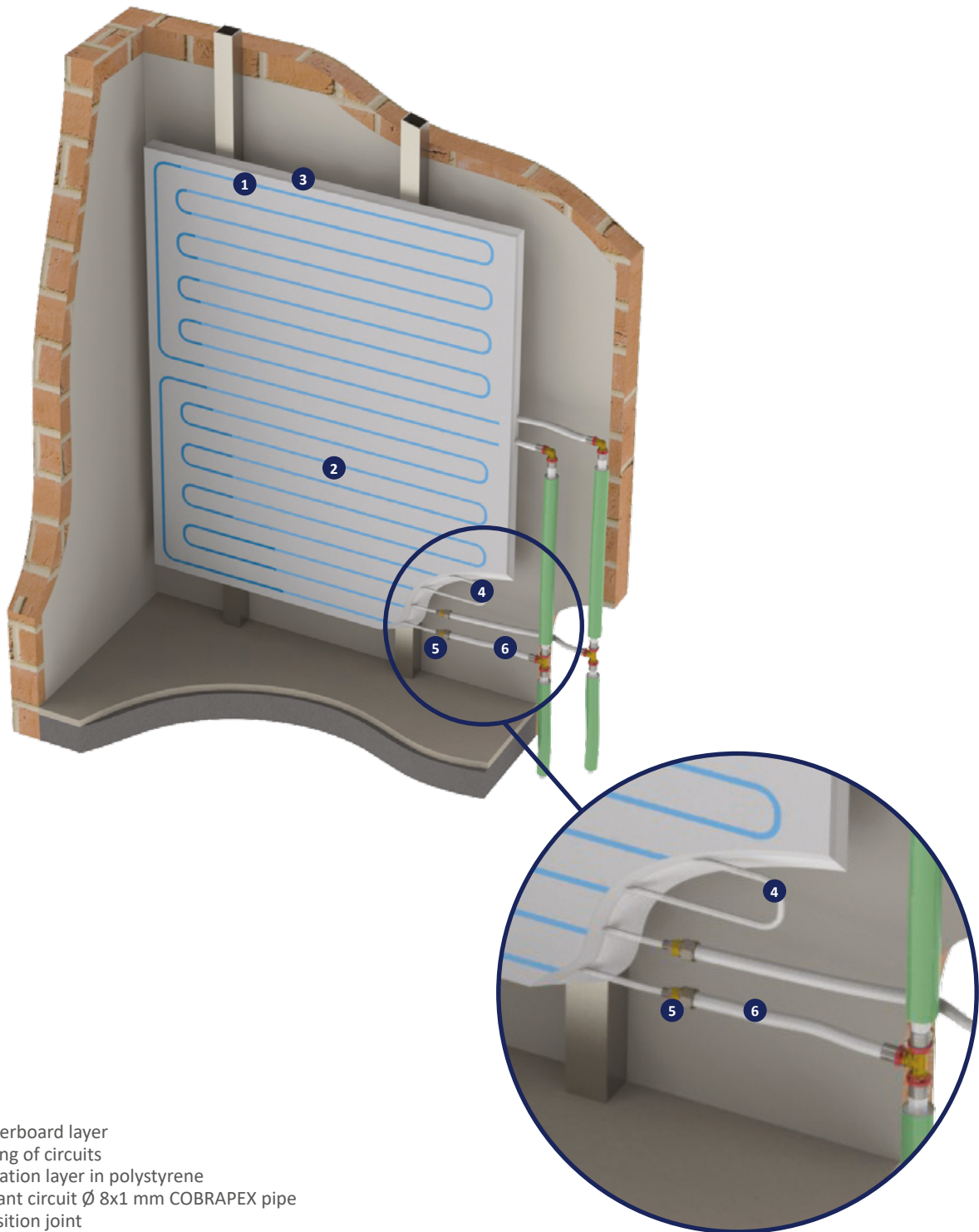

1. Plasterboard layer
2. Tracing of circuits
3. Insulation layer in polystyrene
4. Radiant circuit \varnothing 8x1 mm COBRAPEX pipe
5. Transition joint
6. \varnothing 16x2 mm multilayer pipe



RG

Radiant plasterboard panel for ceiling or wall radiant systems with polystyrene insulation layer.

DESCRIPTION

Composed of:

- Reinforced plasterboard sheet 15 mm thk., thermal conductivity 0.6 W/mk
- Insulating sheet in expanded polystyrene 30 mm thk., thermal conductivity 0.035 W/mk
- Ø 8x1 mm radiant coil made of PE-Xb compliant with EN ISO 15875-2 with oxygen barrier compliant with DIN 4726
- Patented internal transition fitting for adductions made of AL-COBRAPEX multilayer pipe, Ø 16x2 mm, in compliance with EN ISO 21003, to facilitate the hydraulic connection with the network

TECHNICAL CHARACTERISTICS

- Total thickness: 45 mm
- Drawing of the coil on the plasterboard surface for a secure fixing

Code	Dimensions (mm)	Price €/m ²	Unit/Box (m ²)
450 0170	600 x 1000		0,6/ 0,6
450 0161	1200 x 1000		1,2/ 1,2
450 0166	600 x 2000		1,2/ 1,2
450 0165	1200 x 2000		2,4/ 2,4

THERMAL PERFORMANCE OF RADIANT PANELS ACCORDING TO EN 15377*

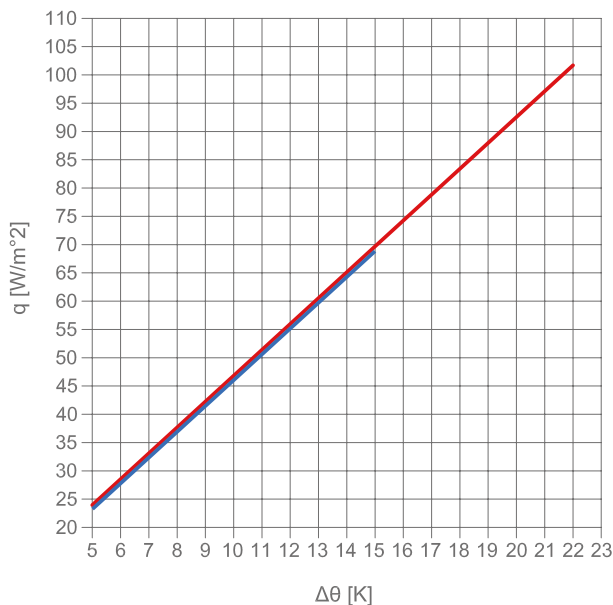

- — Wall heating
- — Wall cooling
- Δθ (K): Temperature difference between average radiant surface temperature and ambient air temperature

* Yields certified by the Department of Technical Physics of the University of Padua

TECHNICAL CHARACTERISTICS

	Codes			
	450 0170	450 0161	450 0166	450 0165
Insulating thickness (mm)	30			
Plasterboard thickness (mm)	15			
Total thickness (mm)	45			
Circuits pipe diameter (mm)	8 x 1			
Thermal conductivity UNI EN 12667 (w/mk)	0,035			
Thermal resistance EN 13163 (m ² k/w)	0,86			
Reaction to fire EN 13501-1 (Euroclass)	E			
Total panel size (mm)	600 x 1000	1200 x 1000	600 x 2000	1200 x 2000
Panel area (m ²)	0,6	1,2	1,2	2,4





RGN

Plasterboard panel for infill of radiant ceiling and wall systems with polystyrene insulation layer

DESCRIPTION:

Composed of:

- Reinforced plasterboard sheet 15 mm thk., thermal conductivity 0.6 W/mk
- Insulating sheet in expanded polystyrene 30 mm thk., thermal conductivity 0.035 W/mk

TECHNICAL CHARACTERISTICS:

- Total thickness: 45 mm
- Weight: 31 kg

Code	Dimensions	Price €/m ²	Unit/Box (m ²)
450 0167	1200 x 2000 mm		2,4/2,4



3670

Y filter for the collection of impurities

TECHNICAL CHARACTERISTICS:

- Filtration: 350 µm to 600 µm depending on diameter
- Body material: brass C W 617N
- Max working pressure: 20 bar up to 2"
- Max operating temperature: 100°C
- Connection threads: female/female ISO 228

Code	Type	Price €	Unit/Box
367 0001	3/4"		18/54
367 0002	1"		10/30
367 0005	1"1/4		4/16
367 0009	1"1/2		3/12
367 0004	2"		2/8

Plug with hole for sealing



5570

Automatic deaerator of bubbles or micro-air bubbles with insulation.

TECHNICAL CHARACTERISTICS

- Body: brass
- Internal elements: stainless steel
- Insulation: EPP
- Operating temperature range: - 10 °C ÷ + 110 °C
- Maximum working pressure: 10 bar

Code	Type	Price €	Unit/Box
556 0001	3/4"		1/4
556 0002	1"		1/4
556 0003	1"1/4		1/4
556 0004	1"1/2		1/3
556 0395	2"		1/4

Without insulation



4539

Corrosion protection of metal parts with universal fungal bactericide for heating and cooling systems.

TECHNICAL CHARACTERISTICS

- Dosage: 1 l of additive x 100 l of circulating water

Code	Type	Price €	Unit/Box
450 0486	1 l		1/12



1651

Double straight connection

i On request available in tinned version

Code	Type	Price €	Unit/Box
165 0016	16 x 16		10/100



1653

Double curved fitting

i On request available in tinned version

Code	Type	Price €	Unit/Box
165 0011	16 x 16		10/100



1657

T fitting

i On request available in tinned version

Code	Type	Price €	Unit/Box
	1 2 3		
165 0002	16 x 16 x 16		10/50

i For the complete range see the catalogue Hydraulic components.

Tiemme has developed a line of ceiling radiant systems ideal for offices, schools, commercial activities, or any other situation related to the tertiary sector.

Tiemme's systems department specializes in design and consulting for the tertiary sector, ensuring support from the first stages of design to the choice of the most suitable products, from the transition to the implementation phase to on-site assistance.



Specific solution for commercial heating and cooling systems where maximum thermal output is required without surface temperature constraints.

1. Metal square
2. Insulation layer in polystyrene
3. Ø 12x1.1 mm Pex pipe
4. T-distributor
5. Ø 20x2 mm multilayer pipe

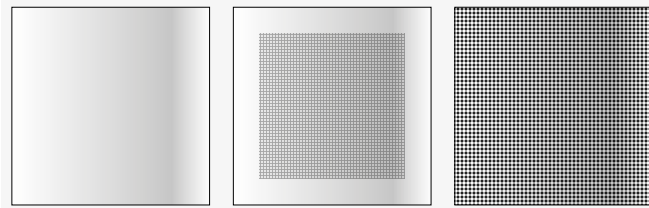
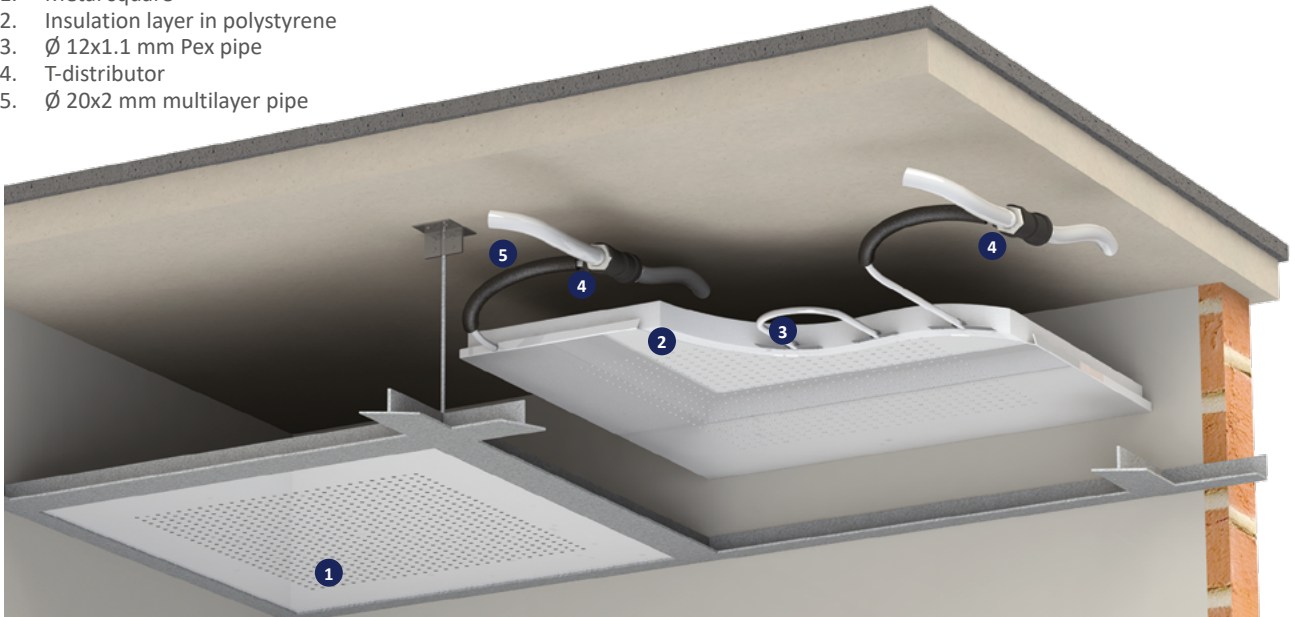

- EPS insulation for maximum thermal performance, rock wool, mineral wool as requested
- Metal panel in steel or aluminium in sizes, colours and finishes fully customizable

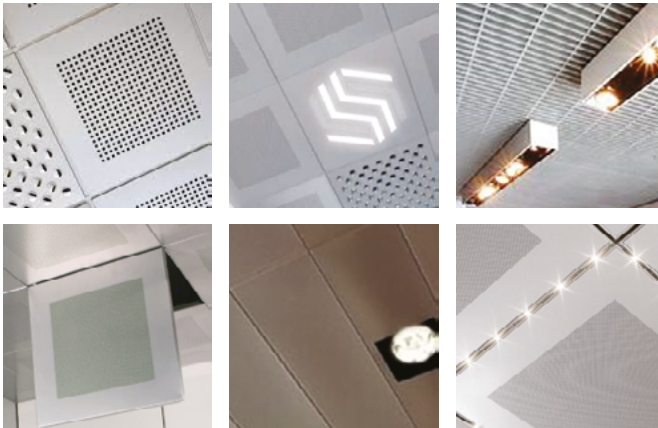

Copper circuits available for a complete customization of the internal piping of the panels.
The copper pipe perfectly calibrated in the required diameter is housed inside the metal diffuser for high thermal performance.



SK600PL

Micro-perforated aluminium radiant panel for ceiling radiant systems with a polystyrene insulation layer, painted white.

DESCRIPTION

Composed of:

- Metallic square in micro-perforated white painted aluminium 0.6 mm thk.
- Insulation layer in polystyrene espanso 30 mm thk., Thermal conductivity 0,0389 W/mK
- Ø 12x1.1 mm radiant coil made of PE-Xb compliant with EN ISO 15875-2 with oxygen barrier compliant with DIN 4726
- Aluminium diffusers for better heat exchange

TECHNICAL CHARACTERISTICS

- Total thickness: 30,6 mm

Code	Dimensions (mm)	Price €	Unit/Box
450 0680	600 x 600		1/1

THERMAL PERFORMANCE OF RADIANT PANELS ACCORDING TO EN 15377*

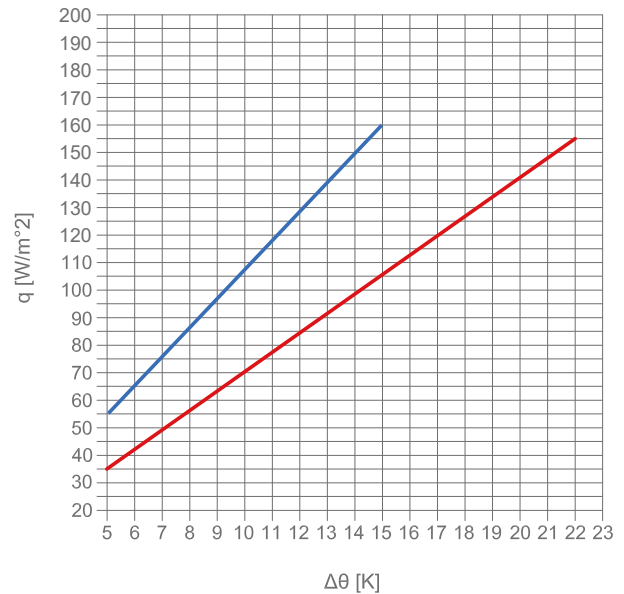

- — Wall heating
- — Wall cooling
- Δθ (K): Temperature difference between average radiant surface temperature and ambient air temperature

* Yields certified by the Department of Technical Physics of the University of Padua

TECHNICAL CHARACTERISTICS

	Codes
	450 0680
Insulating thickness (mm)	30
Thickness of aluminium (mm)	0,6
Total thickness (mm)	30,6
Circuits pipe diameter (mm)	12x1,1
Dorsal diameter (mm)	20x2
Pipe distance (mm)	75
Thermal conductivity UNI EN 12667 (W/mK)	0,0389
Thermal resistance EN 13163 (m²k/W)	0,86
Reaction to fire EN 13501-1 (Euroclass)	E
Total panel size (mm)	600 x 600
Panel area (m²)	0,36





SK600PLN
Micro-perforated aluminium infill panel for ceiling radiant systems, white painted, insulated

TECHNICAL CHARACTERISTICS
• Total thickness: 30,6 mm

Code	Dimensions (mm)	Price €	Unit/Box
450 0494	600 x 600		1/1



0200B
High density COBRAPEX cross-linked polyethylene pipe with EVOH oxygen barrier

Code	Type	Price €/m	Unit/Box (m)
020 0127	12 x 1,1		50/2400
020 0041	12 x 1,1		100/3000



3670
Y filter for the collection of impurities

TECHNICAL CHARACTERISTICS:
• Filtration: 350 µm to 600 µm depending on diameter
• Body material: brass C W 617N
• Max working pressure: 20 bar up to 2"
• Max operating temperature: 100°C
• Connection threads: female/female ISO 228

Code	Type	Price €	Unit/Box
367 0001	3/4"		18/54
367 0002	1"		10/30
367 0005	1"1/4		4/16
367 0009	1"1/2		3/12
367 0004	2"		2/8

Plug with hole for sealing



5570
Automatic deaerator of bubbles or micro-air bubbles with insulation.

TECHNICAL CHARACTERISTICS
• Body: brass
• Internal elements: stainless steel
• Insulation: EPP
• Operating temperature range: - 10 °C ÷ + 110 °C
• Maximum working pressure: 10 bar

Code	Type	Price €	Unit/Box
556 0001	3/4"		1/4
556 0002	1"		1/4
556 0003	1"1/4		1/4
556 0004	1"1/2		1/3
556 0395	2"		1/4

Without insulation



4539
Corrosion protection of metal parts with universal fungal bactericide for heating and cooling systems.

TECHNICAL CHARACTERISTICS
• Dosage: 1 l of additive x 100 l of circulating water

Code	Type	Price €	Unit/Box
450 0486	1 l		1/12



1657
Brass T Press distributor fitting

i Ø 20 connection for multilayer pipe

i Fitting suitable for the construction of risers

Code	Type	Price €	Unit/Box
165 0005	20 x 20 x 20		5/50

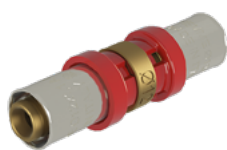

5581
Double straight brass press fitting

i Ø 12 connection for PEX pipe

Code	Type	Price €	Unit/Box
556 0388	12 x 12		10/100



5581T
Brass T Press distributor fitting

i Ø 12 connection for PEX pipe
Ø 20 connection for multilayer pipe

Code	Type	Price €	Unit/Box
556 0386	20 x 12 x 20		5/50



5581C
Double line brass press T distributor fitting

i Ø 12 connection for PEX pipe
Ø 20 connection for multilayer pipe

Code	Type	Price €	Unit/Box
556 0387	20 x 12 x 12 x 20		5/50

i For the complete range of equipment see the catalogue Hydraulic components.



1677
Brass press end fitting

i Ø 20 connection for multilayer pipe

Code	Type	Price €	Unit/Box
165 0216	20		10/100



1695TM01
TIEMME battery-powered press tool standard version for pipe from Ø 14 to Ø 90 inclusive

i The press tool is supplied in a case complete with: rechargeable battery Li-Ion 18Vdc - 2,0 Ah; battery charger; Tongs set (if provided) 16, 20, 26

Code	Set pinze	Price €	Unit/Box
159 0085	not included		1/1



1695TM03
TIEMME battery-operated press tool MINI version for pipe Ø 14 to 32 included

i The press tool is supplied in a case complete with: Li-Ion 12vdc - 2,0 Ah rechargeable battery; battery charger; Tongs set (if provided) Ø 16, 20, 26

Code	Set pinze	Price €	Unit/Box
159 0089	not included		1/1



1681
TH profile tongs - customized TIEMME

Code	Type	Price €	Unit/Box
159 0149	12		1/1



1681MINI
TH profile tongs - customized TIEMME for MINI press

Code	Type	Price €	Unit/Box
159 0128	12		1/1
159 0027	20		1/1



PRICE LIST



EFFICIENT SOLUTIONS INTEGRATED IN MODERN BUILDINGS

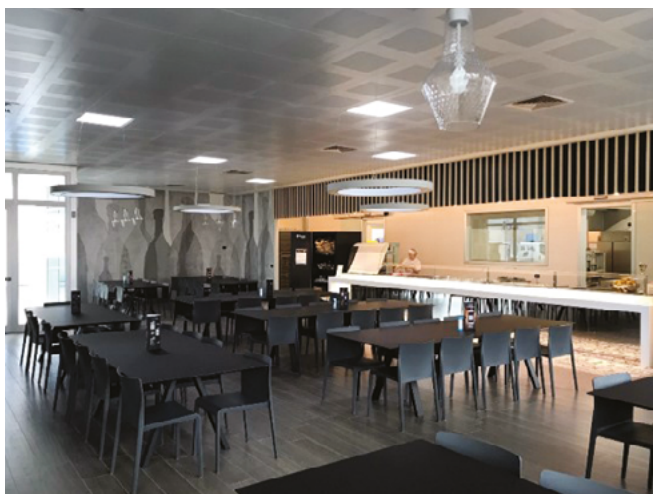

WE GUARANTEE A HIGH COMFORT

Applications in heating and cooling that, thanks to the micro-perforation of the modules, increase the heating/cooling performance and guarantee high comfort.



LET'S THINK ABOUT MAINTENANCE

The inspection of each individual panel makes maintenance easier. It is possible to intervene even when the system is working.

03 RADIANT SYSTEMS FOR INDUSTRIAL USE

03A Radiant systems for industrial use

Radiant systems for industrial use - introduction 86

STRONG RAIL 88

STRONG NET 91

03B Accessories for floor radiant systems 93

Radiant floor heating is now the best way to heat warehouses, sheds, industrial spaces characterized by large sizes and considerable heights.

It is an efficient system both in terms of energy and in terms of resistance to stresses from high loads. Tiemme is a leader in the design and production of radiant systems for industrial use.

TIEMME'S SOLUTIONS

STRONG RAIL

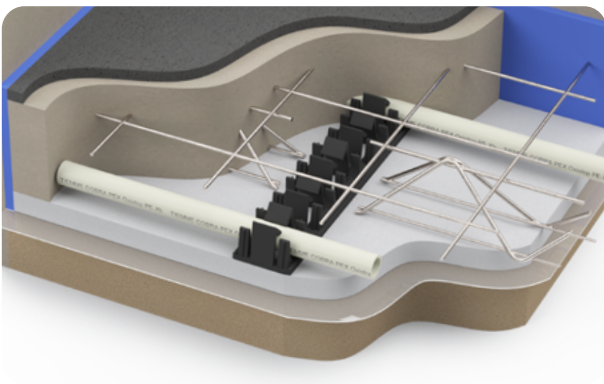

STRONG NET

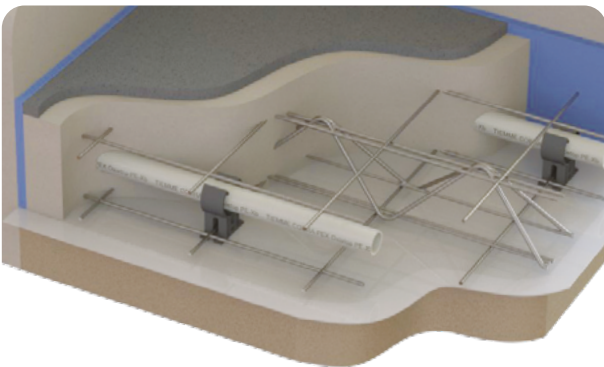

ENERGY SAVING

Choosing to heat a very large room with a floor radiant panel system means significantly reducing operating costs. Compared to an air system, fuel savings of up to 50% are achieved. Exploiting as a radiator the entire floor area, the industrial system allows to operate at very low temperatures and therefore to make the most of low temperature and condensation heat generators.

In addition, the heat transmitted by radiation from the pavement is concentrated in the user's parking areas and not near the roof where it would have no use. In fact, compared to an air system that creates stratification phenomena, a floor heating radiant system generates an almost linear thermal gradient to the point that in the highest part of the structure the air temperature tends to decrease.

These characteristics make it possible to significantly reduce heat losses by transmission, as the temperature difference between the internal and external environment near the dispersing structures and the covers is significantly lower. The significant reduction of thermal dispersion allows to install a heat generator with a much lower power compared to other types of systems, obtaining better levels of comfort. The use of lower thermal powers is equivalent to the reduction of the flow rates to be supplied to the plant and therefore of the diameter of the pipes to be fed to the collectors and of the characteristics of the circulating pumps. Another important factor for energy saving is the fact that the radiant system, operating at low temperatures, allows to exploit the heat coming from alternative energies resulting in a further reduction of heating costs and allowing to amortize in a short time initial costs of construction slightly higher than other types of plant.



PRICE LIST

THE COMFORT

The radiant system, thanks to a homogeneous heat distribution, creates an extremely comfortable environment. The heat is generated in a mild and uniform way and is perceived by the human body in an extremely natural way: the exchange between the source and the environment occurs by radiation and the perception of heat is similar to that of the sun.

The heat radiated from the floor concentrates where it really is needed and creates a physiologically optimal climate for the human body thereby improving working conditions at the level of thermal comfort. For this reason, radiant technology is increasingly widespread in the industrial field.



Traditional heating thermography



Thermography floor heating

FIRE AND SAFETY

In many cases the industrial halls are the place of production processes involving highly flammable materials. Again a floor heating system brings undeniable advantages: The absence of high temperature heating components is a positive factor in the safety level of the working environment.

MAINTENANCE

The low temperature thermal energy carrier fluid allows less stress on the different components of the industrial heating system (heat generators, pipes, fittings, seals) and being an integrated system in the floor we will have a further reduction in maintenance costs.

ABSENCE OF CONVECTIVE AIR MOVEMENTS

A traditional air heating system generates significant temperature differences between the heating bodies and the air itself, producing annoying convective motions. Conversely, in a radiant panel heating system the temperature difference between the floor and the adjacent air is about 5 °C, which is not sufficient to determine convective motions and thus displacement of dust. In addition, the elimination of heating bodies at high temperatures offers the advantage of avoiding the combustion of atmospheric dust by reducing the risk of allergies and ensuring healthy environments and optimal hygienic conditions.

EXPLOITATION OF ALTERNATIVE ENERGY

The high exchange surface of the floor heating allows to operate with a very low temperature thermal energy carrier fluid. The system can then recover and make best use of the heat from processing processes, heat pumps, solar energy, source water, etc. with an additional reduction in heating costs; costs which, at best, can even be reduced to zero.

Ideal solution for industrial heating and cooling systems. The smooth panel in extruded polystyrene is particularly suitable for systems subjected to high loads.

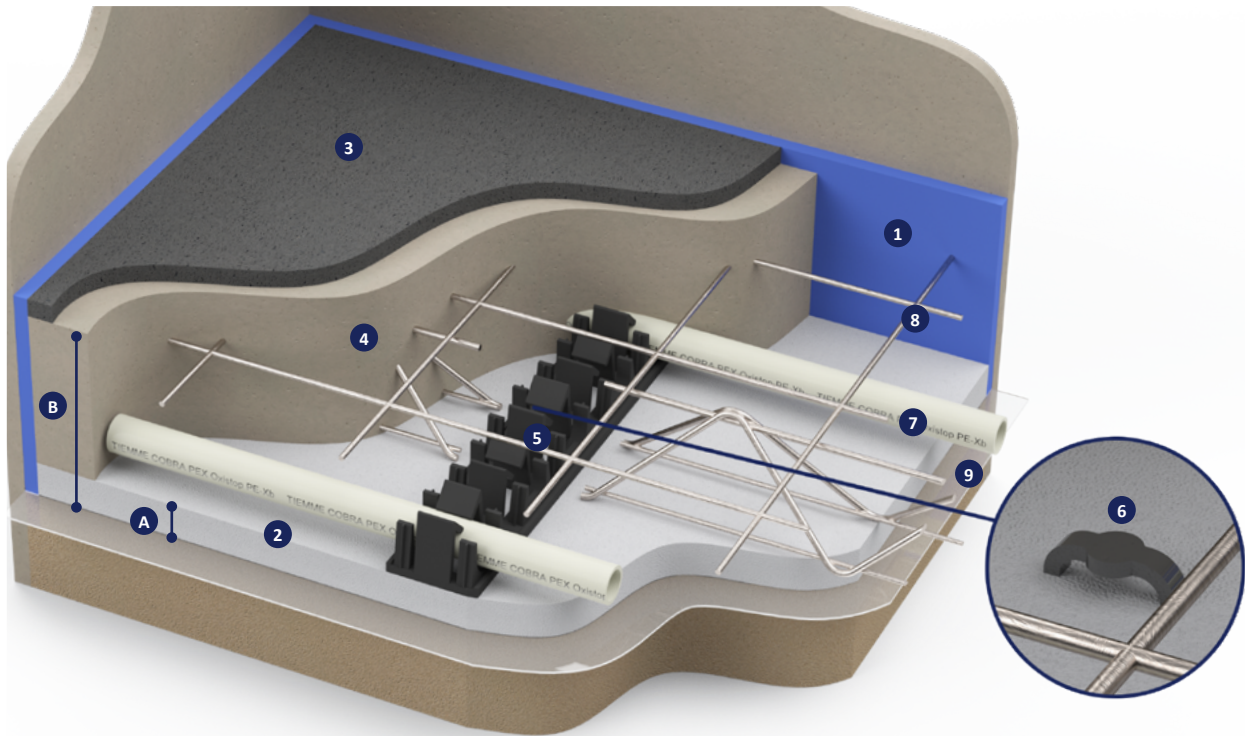

1. Perimeter strip
2. Insulating panel
3. Industrial floor
4. Screed
5. Rail
6. Rail fixing clip
7. Pipe
8. Electro-welded mesh
9. PE sheet

- art. 4507
 art. 450XPS
 -
 -
 art. 4516
 art. 4521
 art. 0200B
 -
 art. 4503

Code	Dimensions (mm)	
	A	B
450 0151	30	180 ÷ 230
450 0163	40	190 ÷ 240
450 0164	50	200 ÷ 250



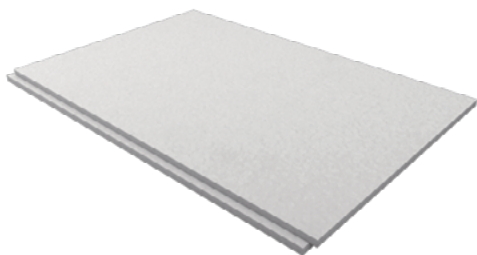

450XPS

XPS extruded polystyrene thermal insulation panel with high compression resistance

Code	Thickness (mm)	Price €/m ²	Packaging (m ²)	Packaging (no. panels)
450 0151	30		9/126	12
450 0163	40		6,75/94,5	9
450 0164	50		6/72	8

TECHNICAL CHARACTERISTICS

	Codes		
	450 0151	450 0163	450 0164
Thermal resistance EN 13164 (m ² K/W)	0,90	1,20	1,40
Compression resistance to 10% UNI EN 826 (kPa)	300		
Insulation thickness (mm)	30	40	50
Total thickness (mm)	30	40	50
Minimum laying pipe distance (mm)	50		
Thermal conductivity UNI EN 12667 (W/mk)	0,033	0,033	0,035
Density (kg/m ³)	35		
Water absorption UNI EN 12087 (%)	0,7		
Reaction to fire EN 13501-1 (Euroclass)	E		
Water vapour diffusion resistance factor (μ)	150		
Total panel size (mm)	1270 x 620		
Useful panel size (mm)	1250 x 600		
Useful panel area (m ²)	0,75		
Panels per package (n)	12	9	8
Panel area per package (m ²)	9	6,75	6



0200B

High density COBRAPEX cross-linked polyethylene pipe with EVOH oxygen barrier.

TECHNICAL CHARACTERISTICS

- Maximum operating temperature: 95 °C
- Thermal conductivity: 0,38 W/mk
- Complies with EN ISO 15875-2
- Anti-oxygen barrier in EVOH compliant with DIN 4726
- Composition: PE-Xb

Code	Type	Price €/m	Unit/Box (m)
020 0011	20 x 2,0		120/2160
020 0012	20 x 2,0		300/2400
020 0004	20 x 2,0		500/2500
020 0009	25 x 2,3		300/1500
020 0097	25 x 2,3		360/1800
020 0108	25 x 2,3		500/1500

New code



4507

Perimeter strip in expanded PE with adhesive back and PE sheet to contain mortar.

Code	Type	Price €/m	Unit/Box (m)
450 0030	H 250 x 8 mm		50/150



1480P

Plastic 90-fold elbow for the protection and support of the COBRAPEX pipe near the connection to the distribution manifold.

Code	Type	Price €	Unit/Box
034 0078	Pipe Ø20		25/300
034 0079	Pipe Ø25		25/150



4521

Clip for fixing the pipe, manual insertion. Made of plastic material complete with anchoring fins.

i Accessory for fixing the 4516 rail to the panel

Code	Type	Price €	Unit/Box
450 0037	H = 50 mm		200/1000



4516

Plastic rail with U-shaped profile for guiding and locking the pipe.

TECHNICAL CHARACTERISTICS

- Length of bars 1 m

i To fix the rail to the panel use the clip 4521

Code	Type	Price €	Unit/Box
450 0308	Pipe Ø 20		32/896
450 0173	Pipe Ø 25		50/50



4540

Screed additive in aqueous solution composed of acrylic polymers; reduces hygroscopic withdrawals by increasing the thermal resistance and improving thermal conductivity.

TECHNICAL CHARACTERISTICS

- Dosage: 1 kg of additive x 100 Kg of cement

Code	Type	Price €/kg	Unit/Box (kg)
450 0019	10 Kg ≈ 9,6 l		10/10
450 0017	25 Kg ≈ 24 l		25/25

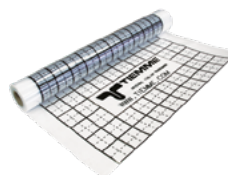

4503

PE sheet with insulation function and moisture barrier.

TECHNICAL CHARACTERISTICS

- Width: 1,2 m
- Length: 100 m
- Thickness: 0,15 mm

Code	Type	Price €/m ²	Unit/Box (m ²)
450 0025	-		120/120



4539

Corrosion protection of metal parts with universal fungal bactericide for heating and cooling systems.

TECHNICAL CHARACTERISTICS

- Dosage: 1 l of additive x 100 l of circulating water

Code	Type	Price €	Unit/Box
450 0486	1 l		1/12



PRICE LIST

Ideal solution for industrial heating and cooling systems. Without an insulating panel, the pipe is fixed with clips placed on a support metal mesh.

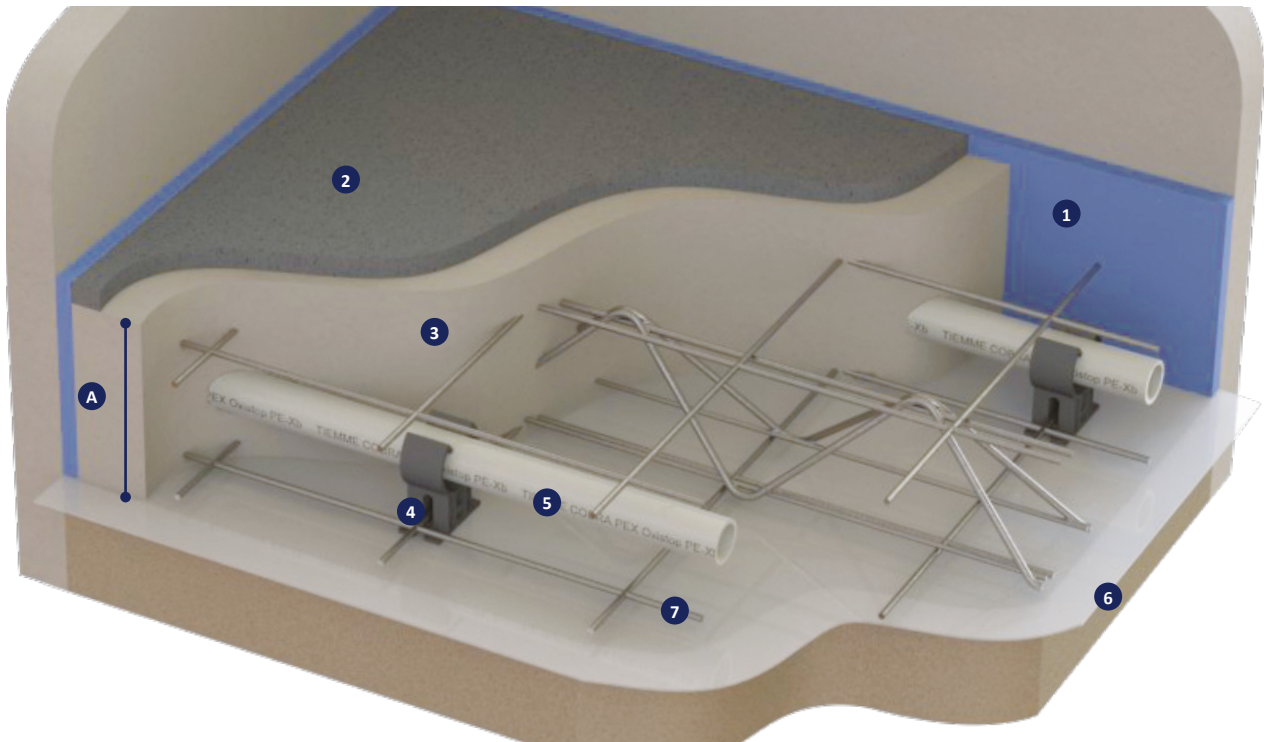

- | | |
|------------------------|------------|
| 1. Perimeter strip | art. 4507 |
| 2. Industrial floor | - |
| 3. Screed | - |
| 4. Pipe fixing clip | art. 4525 |
| 5. Pipe | art. 0200B |
| 6. PE sheet | art. 4503 |
| 7. Electro-welded mesh | art. 4533 |

Code	Dimensions (mm)
	A
-	150 ÷ 200



0200B

High density COBRAPEX cross-linked polyethylene pipe with EVOH oxygen barrier.

TECHNICAL CHARACTERISTICS

- Maximum operating temperature: 95 °C
- Thermal conductivity: 0,38 W/mk
- Complies with EN ISO 15875-2
- Anti-oxygen barrier in EVOH compliant with DIN 4726
- Composition: PE-Xb

Code	Type	Price €/m	Unit/Box (m)
020 0011	20 x 2,0		120/2160
020 0012	20 x 2,0		300/2400
020 0004	20 x 2,0		500/2500
020 0009	25 x 2,3		300/1500
020 0097	25 x 2,3		360/1800
020 0108	25 x 2,3		500/1500

New code



4507

Perimeter strip in expanded PE with adhesive back and PE sheet to contain mortar.

Code	Type	Price €/m	Unit/Box (m)
450 0030	H 250 x 8 mm		50/150



1480P

Plastic 90-fold elbow for the protection and support of the COBRAPEX pipe near the connection to the distribution manifold.

Code	Type	Price €	Unit/Box
034 0078	Pipe Ø20		25/300
034 0079	Pipe Ø25		25/150



4525

Plastic clip, for manual insertion, for fixing the pipe on the electro-welded mesh with Ø 6 mm wire.

Code	Type	Price €	Unit/Box
450 0038	Pipe Ø 20		200/200
450 0066	Pipe Ø 25		200/2000

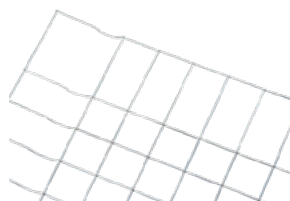

4533

Hot-dip galvanized electro-welded mesh with Ø 6 mm wire and 100x100 mm grid.

Code	Type	Price €/m ²	Unit/Box (m ²)
450 0043	2000 x 2000 mm		40/200



4540

Screed additive in aqueous solution composed of acrylic polymers; reduces hygroscopic withdrawals by increasing the thermal resistance and improving thermal conductivity.

TECHNICAL CHARACTERISTICS

- Dosage: 1 kg of additive x 100 Kg of cement

Code	Type	Price €/kg	Unit/Box (kg)
450 0019	10 Kg ≈ 9,6 l		10/10
450 0017	25 Kg ≈ 24 l		25/25

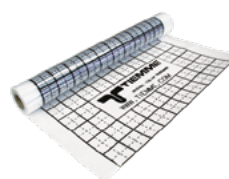

4503

PE sheet with insulation function and moisture barrier.

TECHNICAL CHARACTERISTICS

- Width: 1,2 m
- Length: 100 m
- Thickness: 0,15 mm

Code	Type	Price €/m ²	Unit/Box (m ²)
450 0025	-		120/120



4539

Corrosion protection of metal parts with universal fungal bactericide for heating and cooling systems.

TECHNICAL CHARACTERISTICS

- Dosage: 1 l of additive x 100 l of circulating water

Code	Type	Price €	Unit/Box
450 0486	1 l		1/12



PRICE LIST



4520F
Clip fixing tool.

Code	Type	Price €	Unit/Box
450 0034	-		1/1



4535
System test pump with 1/2" connection

Tank capacity 8 l

Code	Type	Price €	Unit/Box
450 0049	50 bar		1/1



4530
Pipe unwind (up to Ø 20)

Code	Type	Price €	Unit/Box
450 0028	-		1/1



1495
Snips for pipe cutting

Code	Type	Price €	Unit/Box
034 0015	0 - 35		1/5



4522
Screed dryer

Code	Type	Price €	Unit/Box
450 0020	230 Vac 2,5 KW		1/1



4522A
Adapter plugs 230-380 Vac for 4522

Code	Type	Price €	Unit/Box
450 0381	230 - 380 Vac		1/5



1436N
Adapter for bodies with 3/4"x18 union (EUROCONO) for PEX pipe

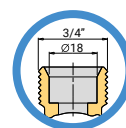

Code	Type	Price €	Unit/Box
144 0011	16 x 2,0 - 3/4" (Ø18)		10/250
144 0012	17 x 2,0 - 3/4" (Ø18)		10/200
144 0019	20 x 2,0 - 3/4" (Ø18)		10/200



1636N
Adapter for bodies with 3/4"x18 union (EUROCONO) for multilayer pipe

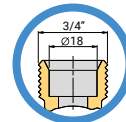

Code	Type	Price €	Unit/Box
144 0002	16 x 2,0 - 3/4" (Ø18)		10/250
144 0003	20 x 2,0 - 3/4" (Ø18)		10/200



1436N06
1" G adapter for PE-X pipe

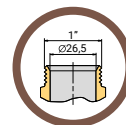

Code	Type	Price €	Unit/Box
144 0232	20 x 2,0 - 1" G		10/200
144 0075	25 x 2,3 - 1" G		10/200



1879
End cap

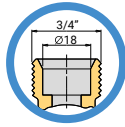

Code	Type	Price €	Unit/Box
144 0071	3/4" (ø18)		10/250



0660S
Cross-linked polyethylene pipe with aluminium core, without box - White

Code	Type	Alum.	Price €/m	Unit/Box (m)
060 0015	16 x 2,0	0,20		500/6000

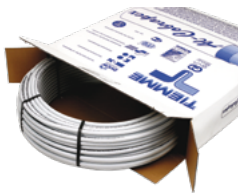

0660
Cross-linked polyethylene pipe with aluminium core – White. In rolls

Code	Type	Alum.	Price €/m	Unit/Box (m)
060 0001	16 x 2,0	0,20		100/3200
060 0010	16 x 2,0	0,20		200/3000



0635
Multilayer pipe 0660 green coated for cooling

Code	Type	Alum.	Thk.	Price €/m	Unit/Box (m)
062 0019	16 x 2,0	0,20	10 mm		50/500
062 0008	20 x 2,0	0,25	10 mm		50/450





PRICE LIST

04 MANIFOLDS AND MIXING UNITS FOR DISTRIBUTION

04A Distribution manifolds for radiant systems

Couple of "FLOOR" manifolds in Forged brass with automatic deaerator and differential by-pass - 1"		96
Couple of "FLOOR" manifolds in Forged brass - 1"		99
Couple of "FLOOR" manifolds in Forged brass - 1"1/4		103
Couple of polyamide manifolds - 1"		107
Couple of polyamide manifolds - 1"1/4		111
Couple of "INDUSTRIAL FLOOR" manifolds in Forged brass - 1"1/2		113
Couple of manifolds in Forged brass for ceiling installation - 1"		116

04B Mixing and distribution units for radiant systems

Fixed point mixing and distribution units - 1"		117
Climate control mixing and distribution units - 1"		121

04C ACCESSORIES for manifolds and mixing and distribution units		124
---	---	-----

04A COUPLE OF "FLOOR" MANIFOLDS IN FORGED BRASS WITH AUTOMATIC DEAERATOR AND DIFFERENTIAL BY-PASS - 1"

Tiemme distribution manifolds art. 3873JBYD - 3873RBYDJ are the ideal solution for the construction of a heating/cooling system.

Equipped with automatic deaerator and by-pass differential, guarantee effectively air outlet from the plant in operation and the correct flow management.

Available with 1" connections with phased male/female thread, with 2÷14 ways arranged with 3/4" connections (Ø 18) Eurocono with or without insulation.

The manifolds are supplied complete with shut-off valves with thermometer holder and tap/s for loading and unloading. The flow rate of each individual way is adjustable with flowmeter. On the return manifold, the thermostatic manual shut-off valves are supplied with an easily replaceable protective cap with 9567 electro-thermal servo control.

DIFFERENTIAL BY-PASS

In radiant systems the distribution circuits can be intercepted through the use of electro-thermal servo controls. The progressive reduction of flow, due to the partial or total closure of individual circuits, causes the pressure to rise 9 differential until noise, temperature inhomogeneity, high fluid speeds and hydraulic system imbalance can arise.

The differential by-pass kit introduced in the manifold Tiemme art. 3873JBYD - 3873RBYDJ keeps the pressure of the entire system balanced. Inside the bypass there is a non-return valve consisting of a precalibrated spring to 15 kPa, not modifiable.

The valve opens gradually and automatically when the spring pressure is reached. In this way starts a recirculation of fluid in the by-pass whose flow is directly proportional to the progressive closure of the electro-thermal servo controls allowing in this way to maintain constant differential pressure within the system. Thanks to its compactness, the differential bypass introduced in the manifolds for radiant systems does not need in any way to change the dimensions of our manifolds and can also be combined with manifolds already installed and in use.

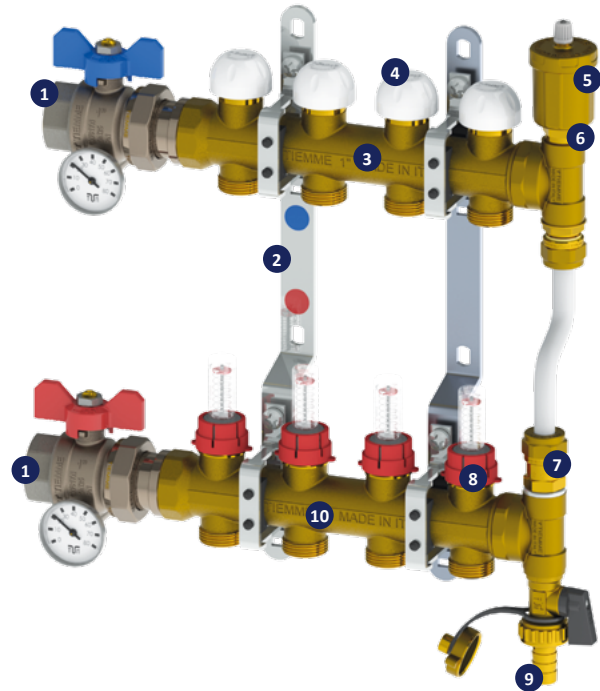
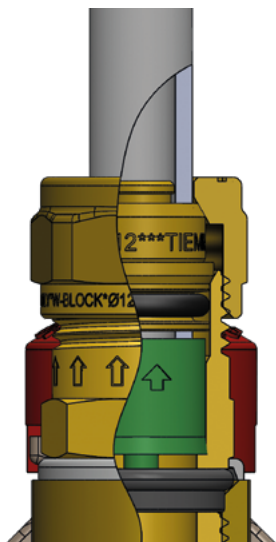

1. Full bore shut-off ball valve with thermometer
2. Fixing brackets
3. Return manifold
4. Thermostatic manual shut-off valves with protective cap
5. Automatic deactivator
6. Check valve
7. Differential By-Pass 15 kPa
8. Flowmeters
9. Loading and unloading valve
10. Delivery manifold

TECHNICAL CHARACTERISTICS

- Differential By-Pass: 15kPa
- Max operating temperature: 110 °C
- Min operating temperature: -20 °C
- Max working pressure: 10 bar
- Suitable fluids: water (with glycol < 50%)
- Manifold threads: Male/Female ISO 228
- Outlets connections: 3/4" (Ø18) (Eurocono)
- Brass parts material: Brass CW617N
- Gaskets material: ethylene-propylene rubber (EPDM)
- Brackets material: galvanized steel



PRICE LIST

04A COUPLE OF "FLOOR" MANIFOLDS IN FORGED BRASS WITH AUTOMATIC DEAERATOR AND DIFFERENTIAL BY-PASS - 1"

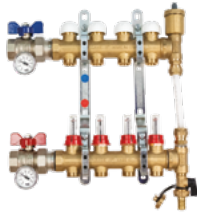

3873JBYD

1" distribution manifold with differential by-pass and flowmeters

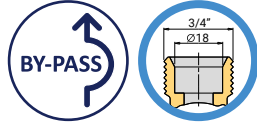

i Can be combined with box art. 1939

Code	Type	Ways	Price €	Unit/Box
385 0255	1"G	2		1/1
385 0256	1"G	3		1/1
385 0257	1"G	4		1/1
385 0258	1"G	5		1/1
385 0259	1"G	6		1/1
385 0260	1"G	7		1/1
385 0261	1"G	8		1/1
385 0262	1"G	9		1/1
385 0263	1"G	10		1/1
385 0264	1"G	11		1/1
385 0265	1"G	12		1/1
385 0268	1"G	13		1/1
385 0269	1"G	14		1/1

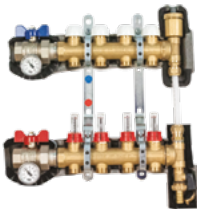

3873RBYDJ

1" insulated distribution manifold with differential by-pass and flowmeters

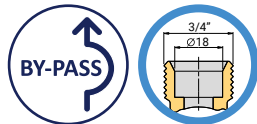

i Can be combined with box art. 1940

Code	Type	Ways	Price €	Unit/Box
557 0653	1"G	2		1/1
557 0654	1"G	3		1/1
557 0655	1"G	4		1/1
557 0656	1"G	5		1/1
557 0657	1"G	6		1/1
557 0658	1"G	7		1/1
557 0659	1"G	8		1/1
557 0660	1"G	9		1/1
557 0661	1"G	10		1/1
557 0662	1"G	11		1/1
557 0663	1"G	12		1/1
557 0670	1"G	13		1/1
557 0671	1"G	14		1/1

ACCESSORIES AND SPARE PARTS

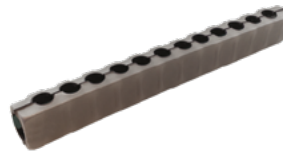

3051ISOL

1" manifold insulation shell

Code	Type	Price €	Unit/Box
557 0121	1"		1/6



1890JISOL

1" terminal group insulation shell and automatic air vent valve

Code	Type	Price €	Unit/Box
557 0668	1"		1/12



2121PTISOL

Insulation shell for 1" ball valve with thermometer holder

Code	Type	Price €	Unit/Box
557 0119	1"		1/12

DIMENSIONS

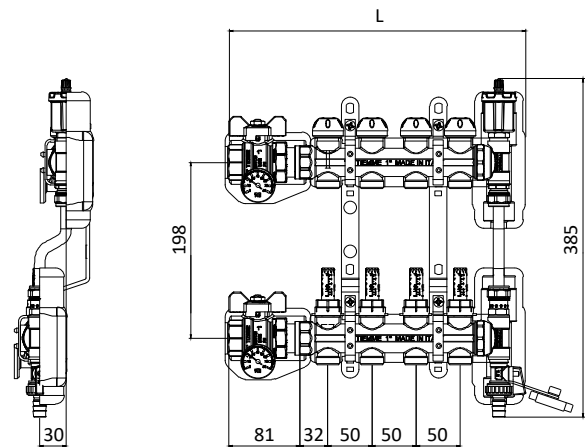

i For the complete range of accessories and spare parts see page 124

04A COUPLE OF "FLOOR" MANIFOLDS IN FORGED BRASS WITH AUTOMATIC DEAERATOR AND DIFFERENTIAL BY-PASS - 1"



1939

Height and depth adjustable box for manifolds

i Adjustable depth from 90 mm to 140 mm

Code	Type	Price €	Unit/Box
181 0192	400 x 660 x 90 ÷ 140		1/1
181 0193	500 x 660 x 90 ÷ 140		1/1
181 0206	600 x 660 x 90 ÷ 140		1/1
181 0194	700 x 660 x 90 ÷ 140		1/1
181 0195	1000 x 660 x 90 ÷ 140		1/1

1939

DIMENSIONS

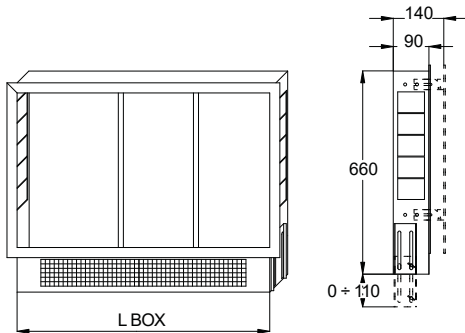

GUIDE TO THE CHOICE OF BOXES

MANIFOLD COMPATIBILITY: 3873JBYD

Ways No.	L* (mm)	L BOX (mm)	Code
2	232	400	181 0192
3	282		
4	332		
5	382	500	181 0193
6	432		
7	482	600	181 0206
8	532		
9	582	700	181 0194
10	632		
11	682	1000	181 0195
12	732		
13	782		
14	832		

* Manifold width



1940

Height and depth adjustable box for mixing and distribution units and manifolds

i Adjustable depth from 120 mm to 170 mm

Code	Type	Price €	Unit/Box
181 0020	600 x 670 x 120 ÷ 170		1/1
181 0016	700 x 670 x 120 ÷ 170		1/1
181 0015	850 x 670 x 120 ÷ 170		1/1
181 0019	1000 x 670 x 120 ÷ 170		1/1

1940

DIMENSIONS

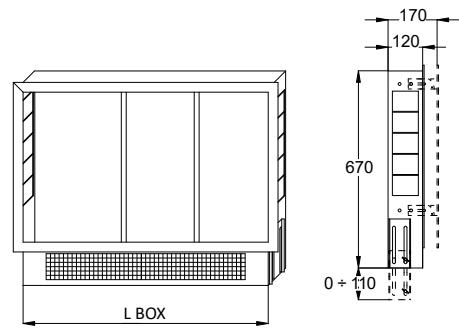

GUIDE TO THE CHOICE OF BOXES

MANIFOLD COMPATIBILITY: 3873RBYDJ

Ways No.	L* (mm)	L BOX (mm)	Code
2	262	600	181 0020
3	312		
4	362		
5	412		
6	462	700	181 0016
7	512		
8	562		
9	612	850	181 0015
10	662		
11	712		
12	762		
13	812	1000	181 0019
14	862		

* Manifold width



04_A COUPLE OF "FLOOR" MANIFOLDS IN FORGED BRASS - 1"

Tiemme distribution manifolds art. 3873 - 3878 are the ideal solution for the realization of a heating/cooling system. Available with 1" connections with male/female threads and with 2÷14 ways prepared with 3/4" connections (Ø 18) Eurocono.

The manifolds are supplied complete with shut-off valves with thermometer holder, air vent valve/s and tap/s for loading and unloading. Tiemme distribution manifolds are also available with differential by-pass (art. 3878BYD), without by-pass (art. 3873-3878) or with insulation (art. 3873R-3873RBYD).

The flow rate of each individual way is adjustable with flowmeter (art. 3873) or with mechanical memory screw (art. 3878).

On the return manifold, the thermostatic manual shut-off valves are supplied with a protection cap, easily replaceable at a later time with electrothermal servo control art. 9567.

TECHNICAL CHARACTERISTICS

- Differential By-Pass: 15 KPa
- Max operating temperature: 110 °C
- Min operating temperature: -20 °C
- Max working pressure: 10 bar
- Suitable fluids: water (with glycol < 50%)
- Manifold threads: Male/Female ISO 228
- Outlets connections: 3/4" (Ø18) Eurocono
- Brass parts material: Brass CW617N
- Gaskets material: EPDM
- Brackets material: galvanized steel

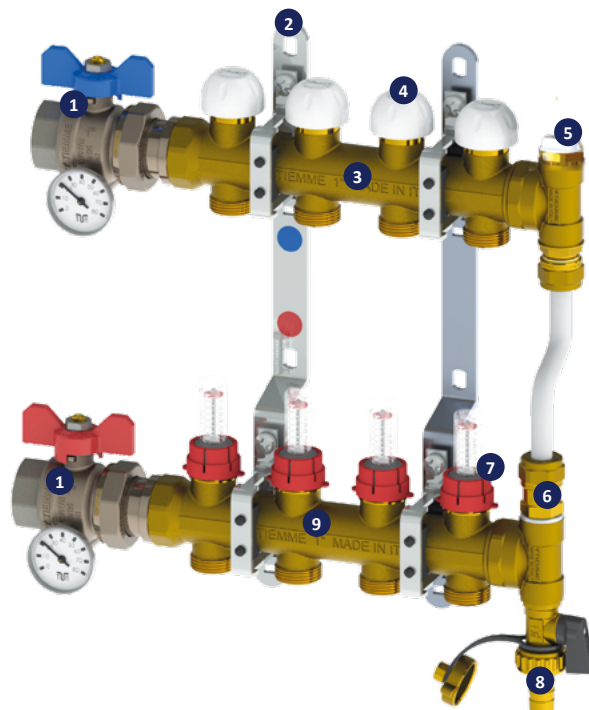

1. Full bore shut-off ball valve with thermometer
2. Fixing brackets
3. Return manifold
4. Thermostatic manual shut-off valves with protective cap
5. Manual vent valve
6. Differential By-Pass 15 kPa
7. Flowmeters / or mechanical memory screws
8. Loading and unloading valve
9. Delivery manifold

04_A COUPLE OF "FLOOR" MANIFOLDS IN FORGED BRASS - 1"



3873
1" distribution manifold with flowmeters

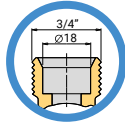

i Can be combined with box art. 1939

Code	Type	Ways	Price €	Unit/Box
385 0045	1"G	2		1/1
385 0029	1"G	3		1/1
385 0020	1"G	4		1/1
385 0011	1"G	5		1/1
385 0010	1"G	6		1/1
385 0009	1"G	7		1/1
385 0002	1"G	8		1/1
385 0014	1"G	9		1/1
385 0036	1"G	10		1/1
385 0041	1"G	11		1/1
385 0022	1"G	12		1/1
385 0118	1"G	13		1/1
385 0119	1"G	14		1/1



3878
1" distribution manifold with mechanical memory screws

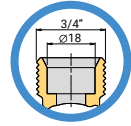

i Can be combined with box art. 1939

Code	Type	Ways	Price €	Unit/Box
385 0040	1"G	2		1/1
385 0042	1"G	3		1/1
385 0035	1"G	4		1/1
385 0030	1"G	5		1/1
385 0028	1"G	6		1/1
385 0044	1"G	7		1/1
385 0031	1"G	8		1/1
385 0065	1"G	9		1/1
385 0058	1"G	10		1/1
385 0057	1"G	11		1/1
385 0060	1"G	12		1/1



3878BYD
1" distribution manifold with differential by-pass and mechanical memory screws



i Can be combined with box art. 1939

+ With Differential By-Pass

Code	Type	Ways	Price €	Unit/Box
385 0068	1"G	2		1/1
385 0069	1"G	3		1/1
385 0067	1"G	4		1/1
385 0064	1"G	5		1/1
385 0052	1"G	6		1/1
385 0066	1"G	7		1/1
385 0033	1"G	8		1/1
385 0055	1"G	9		1/1
385 0051	1"G	10		1/1
385 0050	1"G	11		1/1
385 0056	1"G	12		1/1



04_A COUPLE OF "FLOOR" MANIFOLDS IN FORGED BRASS - 1"

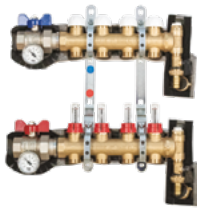

3873R
1" insulated distribution manifold with flowmeters

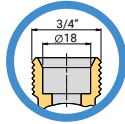

i Can be combined with box art. 1940

Code	Type	Ways	Price €	Unit/Box
557 0029	1"G	2		1/1
557 0030	1"G	3		1/1
557 0031	1"G	4		1/1
557 0032	1"G	5		1/1
557 0033	1"G	6		1/1
557 0034	1"G	7		1/1
557 0035	1"G	8		1/1
557 0036	1"G	9		1/1
557 0037	1"G	10		1/1
557 0038	1"G	11		1/1
557 0039	1"G	12		1/1
557 0672	1"G	13		1/1
557 0673	1"G	14		1/1

ACCESSORIES AND SPARE PARTS

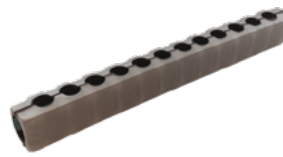

3051ISOL
1" manifold insulation shell

Code	Type	Price €	Unit/Box
557 0121	1"		1/6



1890ISOL
1" terminal group insulation shell and air vent valve

Code	Type	Price €	Unit/Box
557 0117	1"		1/12



2121PTISOL
Insulation shell for 1" ball valve with thermometer holder

Code	Type	Price €	Unit/Box
557 0119	1"		1/12

DIMENSIONS

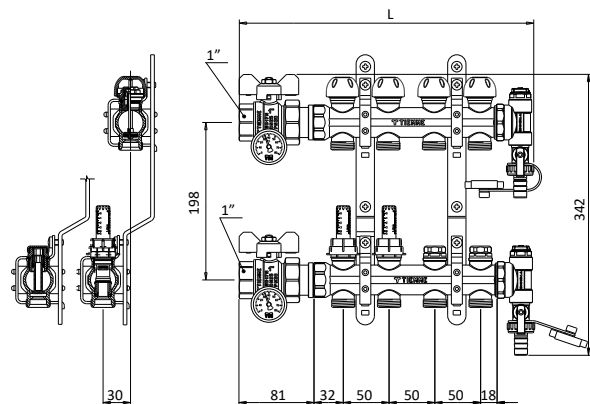

i For the complete range of accessories and spare parts see page 124

04_A COUPLE OF "FLOOR" MANIFOLDS IN FORGED BRASS - 1"



1939
Height and depth adjustable box for manifolds

i Adjustable depth from 90 mm to 140 mm

Code	Type	Price €	Unit/Box
181 0192	400 x 660 x 90 ÷ 140		1/1
181 0193	500 x 660 x 90 ÷ 140		1/1
181 0206	600 x 660 x 90 ÷ 140		1/1
181 0194	700 x 660 x 90 ÷ 140		1/1
181 0195	1000 x 660 x 90 ÷ 140		1/1

1939 DIMENSIONS

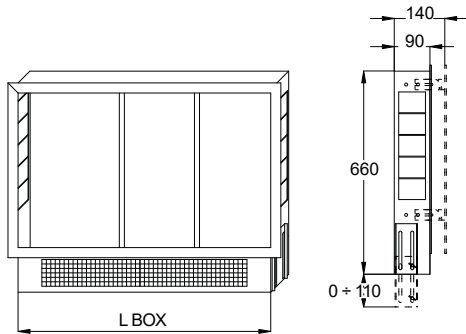

GUIDE TO THE CHOICE OF BOXES

MANIFOLD COMPATIBILITY: 3873 - 3878 - 3878BYD

Ways No.	L* (mm)	L BOX (mm)	Code
2	232	400	181 0192
3	282		
4	332		
5	382	500	181 0193
6	432		
7	482	600	181 0206
8	532		
9	582	700	181 0194
10	632		
11	682	1000	181 0195
12	732		
13	782		
14	832		

* Manifold width



1940
Height and depth adjustable box for mixing and distribution units and manifolds

i Adjustable depth from 120 mm to 170 mm

Code	Type	Price €	Unit/Box
181 0020	600 x 670 x 120 ÷ 170		1/1
181 0016	700 x 670 x 120 ÷ 170		1/1
181 0015	850 x 670 x 120 ÷ 170		1/1
181 0019	1000 x 670 x 120 ÷ 170		1/1

1940 DIMENSIONS

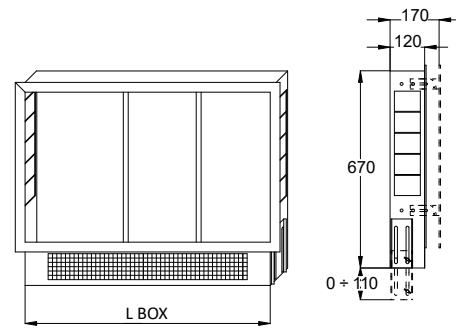

GUIDE TO THE CHOICE OF BOXES

MANIFOLD COMPATIBILITY: 3873R

Ways No.	L* (mm)	L BOX (mm)	Code
2	262	600	181 0020
3	312		
4	362		
5	412		
6	462	700	181 0016
7	512		
8	562	850	181 0015
9	612		
10	662	1000	181 0019
11	712		
12	762		
13	812		
14	862		

* Manifold width



Tiemme distribution manifolds art. 3877 - 3879 are the ideal solution for the realization of a heating and/or cooling system. Available with 1"1/4 connections with male/ female threads and with 2÷12-way 3/4" connections (Ø 18) Eurocono. The manifolds are supplied complete with shut-off valves, air vent valve/s and air tap/s for loading and unloading.

Tiemme distribution manifolds are also available with differential by-pass (art. 3877BYD - 3879BYD) or without by-pass (art. 3877 - 3879). The flow rate of each individual way is adjustable with a flowmeter (art. 3877 - 3877BYD) or with a mechanical memory screw (art. 3879 - 3879BYD).

On the return manifold, the thermostatic manual shut-off valves are supplied with a protection cap, easily replaceable at a later time with electrothermal servo control art. 9567.

TECHNICAL CHARACTERISTICS

- Max operating temperature: 110 °C
- Min operating temperature: -20 °C
- Max working pressure: 10 bar
- Suitable fluids: water (with glycol < 50%)
- Manifold threads: Male/Female ISO 228
- Outlets connections: 3/4" (Ø18) (Eurocono)
- Brass parts material: Brass CW617N
- Gaskets material: EPDM
- Brackets material: galvanized steel

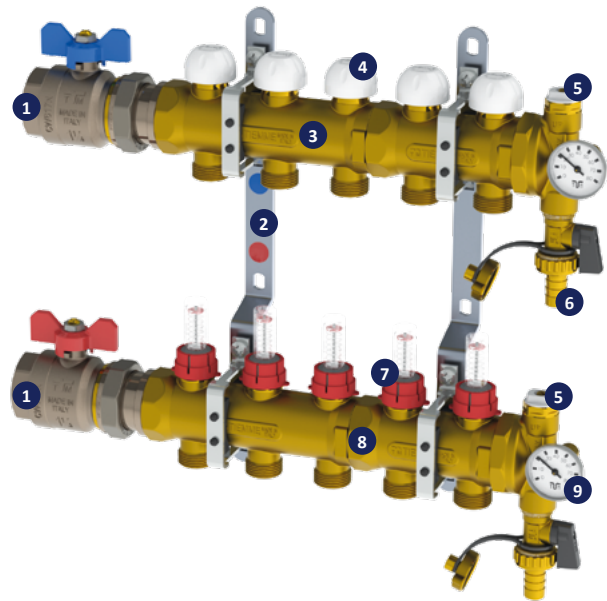

1. Full bore shut-off ball valve
2. Fixing brackets
3. Return manifold
4. Thermostatic manual shut-off valves with protective cap
5. Manual vent valve
6. Loading and unloading valve
7. Flow meters/screw heads with mechanical memory
8. Delivery manifold
9. Thermometer

04_A COUPLE OF "FLOOR" MANIFOLDS IN FORGED BRASS - 1"1/4

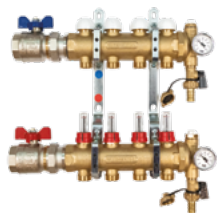

3877
1" 1/4 distribution manifold
with flowmeters

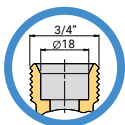

Code	Type	Ways	Price €	Unit/Box
385 0122	1" 1/4G	2		1/1
385 0123	1" 1/4G	3		1/1
385 0124	1" 1/4G	4		1/1
385 0125	1" 1/4G	5		1/1
385 0126	1" 1/4G	6		1/1
385 0127	1" 1/4G	7		1/1
385 0128	1" 1/4G	8		1/1
385 0129	1" 1/4G	9		1/1
385 0130	1" 1/4G	10		1/1
385 0131	1" 1/4G	11		1/1
385 0132	1" 1/4G	12		1/1



3879
1" 1/4 distribution manifold
with mechanical memory
screws

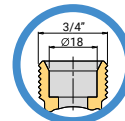

Code	Type	Ways	Price €	Unit/Box
385 0144	1" 1/4G	2		1/1
385 0145	1" 1/4G	3		1/1
385 0146	1" 1/4G	4		1/1
385 0147	1" 1/4G	5		1/1
385 0148	1" 1/4G	6		1/1
385 0149	1" 1/4G	7		1/1
385 0150	1" 1/4G	8		1/1
385 0151	1" 1/4G	9		1/1
385 0152	1" 1/4G	10		1/1
385 0153	1" 1/4G	11		1/1
385 0154	1" 1/4G	12		1/1



3877BYD
1" 1/4 distribution manifold
with differential by-pass and
flowmeters



With Differential By-Pass

Code	Type	Ways	Price €	Unit/Box
385 0133	1" 1/4G	2		1/1
385 0134	1" 1/4G	3		1/1
385 0135	1" 1/4G	4		1/1
385 0136	1" 1/4G	5		1/1
385 0137	1" 1/4G	6		1/1
385 0138	1" 1/4G	7		1/1
385 0139	1" 1/4G	8		1/1
385 0140	1" 1/4G	9		1/1
385 0141	1" 1/4G	10		1/1
385 0142	1" 1/4G	11		1/1
385 0143	1" 1/4G	12		1/1



3879BYD
1" 1/4 distribution manifold
with differential by-pass and
mechanical memory screws



With Differential By-Pass

Code	Type	Ways	Price €	Unit/Box
385 0155	1" 1/4G	2		1/1
385 0156	1" 1/4G	3		1/1
385 0157	1" 1/4G	4		1/1
385 0158	1" 1/4G	5		1/1
385 0159	1" 1/4G	6		1/1
385 0160	1" 1/4G	7		1/1
385 0161	1" 1/4G	8		1/1
385 0162	1" 1/4G	9		1/1
385 0163	1" 1/4G	10		1/1
385 0164	1" 1/4G	11		1/1
385 0165	1" 1/4G	12		1/1



04_A COUPLE OF "FLOOR" MANIFOLDS IN FORGED BRASS - 1"1/4

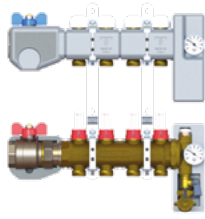

3877R
1" 1/4 insulated distribution manifold with flowmeters

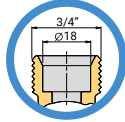

Code	Type	Ways	Price €	Unit/Box
557 0571	1" 1/4G	2		1/1
557 0572	1" 1/4G	3		1/1
557 0573	1" 1/4G	4		1/1
557 0574	1" 1/4G	5		1/1
557 0575	1" 1/4G	6		1/1
557 0576	1" 1/4G	7		1/1
557 0577	1" 1/4G	8		1/1
557 0578	1" 1/4G	9		1/1
557 0579	1" 1/4G	10		1/1
557 0580	1" 1/4G	11		1/1
557 0581	1" 1/4G	12		1/1

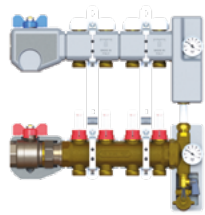

3877RBYD
1" 1/4 insulated distribution manifold with differential by-pass and flowmeters

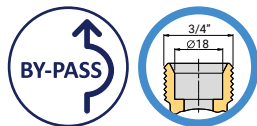

With Differential By-Pass

Code	Type	Ways	Price €	Unit/Box
557 0582	1" 1/4G	2		1/1
557 0583	1" 1/4G	3		1/1
557 0584	1" 1/4G	4		1/1
557 0585	1" 1/4G	5		1/1
557 0586	1" 1/4G	6		1/1
557 0587	1" 1/4G	7		1/1
557 0588	1" 1/4G	8		1/1
557 0589	1" 1/4G	9		1/1
557 0590	1" 1/4G	10		1/1
557 0591	1" 1/4G	11		1/1
557 0592	1" 1/4G	12		1/1

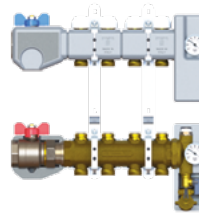

3879R
1" 1/4 insulated distribution manifold with mechanical memory screws

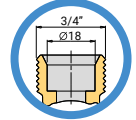

Code	Type	Ways	Price €	Unit/Box
557 0561	1" 1/4G	2		1/1
557 0562	1" 1/4G	3		1/1
557 0563	1" 1/4G	4		1/1
557 0564	1" 1/4G	5		1/1
557 0565	1" 1/4G	6		1/1

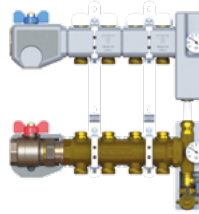

3879RBYD
1" 1/4 insulated distribution manifold with differential by-pass and mechanical memory screws



With Differential By-Pass

Code	Type	Ways	Price €	Unit/Box
557 0566	1" 1/4G	2		1/1
557 0567	1" 1/4G	3		1/1
557 0568	1" 1/4G	4		1/1
557 0569	1" 1/4G	5		1/1
557 0570	1" 1/4G	6		1/1

04_A COUPLE OF "FLOOR" MANIFOLDS IN FORGED BRASS - 1"1/4

ACCESSORIES

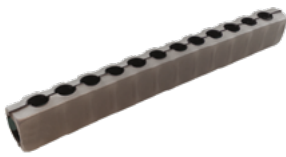

3051ISOL
1"1/4 manifold insulation shell

Code	Type	Price €	Unit/Box
557 0122	1"1/4		1/5



1890ISOL
1"1/4 - 1"1/2 terminal group insulation shell and air vent valve

Code	Type	Price €	Unit/Box
557 0516	1"1/4 - 1"1/2		1/10



2121PTISOL
Insulation shell for 1"1/4 ball valve with thermometer holder

Code	Type	Price €	Unit/Box
557 0120	1"1/4		1/10

DIMENSIONS

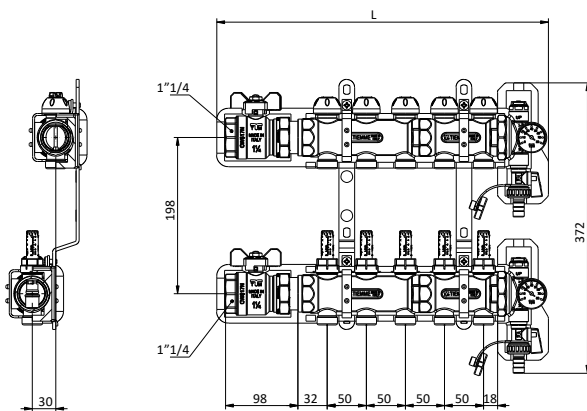

1940
Height and depth adjustable box for mixing and distribution units and manifolds

i Adjustable depth from 120 mm to 170 mm

Code	Type	Price €	Unit/Box
181 0020	600 x 670 x 120 ÷ 170		1/1
181 0016	700 x 670 x 120 ÷ 170		1/1
181 0015	850 x 670 x 120 ÷ 170		1/1
181 0019	1000 x 670 x 120 ÷ 170		1/1

1940 DIMENSIONS

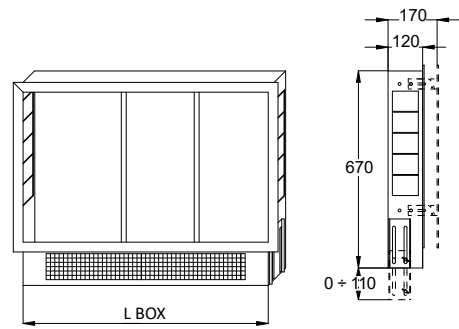

GUIDE TO THE CHOICE OF BOXES

MANIFOLD COMPATIBILITY: 3877 - 3877BYD - 3879 - 3879BYD - 3877R - 3877RBYD - 3879R - 3879RBYD

Ways No.	L* (mm)	L BOX (mm)	Code
2	262	600	181 0020
3	312		
4	362		
5	412		
6	462		
7	512	700	181 0016
8	562		
9	612		
10	662	850	181 0015
11	712		
12	762		

* Manifold width

i For the complete range of accessories and spare parts see p. 124



04_A COUPLE OF POLYAMIDE MANIFOLDS - 1"

DOUBLE CHAMBER

The distribution manifold art. 3871POL is made of thermoplastic material with high technological content, designed for radiant heating and cooling systems with double anti-condensation chamber.

These are patented modular manifolds complete with flowmeters with graduated scale and with the possibility of total closure of the way on the delivery module.

Each return module is equipped with a thermostat insert for the application of an electrothermal actuator.

The 3/4" x 18 Eurocono outlet are perfectly compatible with both PEX and multilayer pipes.

The low pressure losses (characteristic due to the particular shape of the supply and return modules) allow the use of pipes for the heating circuits with a significantly reduced diameter.

To obtain these characteristics, high-tech thermoplastic materials have been used. In particular, the material constituting the modules is a polyamide reinforced with 50% fiberglass with mechanical characteristics similar to light alloys but with significantly higher resistance to atmospheric agents. Another essential feature of the manifolds is that it is absolutely impervious to limestone sediments and therefore the protection from any type of corrosion.

TECHNICAL CHARACTERISTICS

- Max percentage of glycol: 50%
- Operating pressure: 1,5 ÷ 2,5 bar
- Maximum working pressure: 6 bar
- Temperature range: 4 °C ÷ 70 °C

DELIVERY MODULE MATERIALS

- Body: PAS777
- Partializer: PES
- Index of flow: POM
- Cap: CW614N
- Handle: ABS
- Cap cover: ABS
- O-ring: NBR

RETURN MODULES MATERIALS

- Body: PAS777
- Thermostatic block: CW614N
- Dipstick: AISI303
- Spring: AISI302
- Handle: ABS
- O-ring: NBR

HEAD/TERMINAL KIT MATERIALS

- Air vent/terminal body: PAS777
- Bracket/collar: Steel
- Screws: C15
- Threaded bar: Fe37 galvanized CR3
- Brass components: CW617N

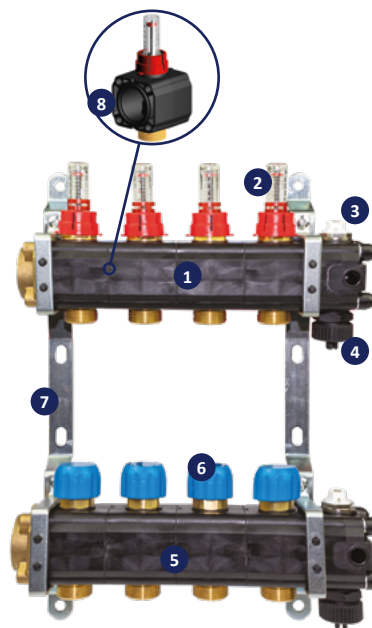

1. Delivery manifold
2. Flowmeters
3. Manual vent valve
4. Loading and unloading valve
5. Return manifold
6. Thermostatic manual shut-off valves with protective cap
7. Fixing brackets
8. Double chamber

PRODUCT RANGE

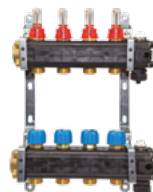

3871POL

Double chamber 1" distribution manifold in polyamide with flowmeters

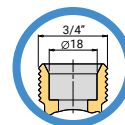

Code	Type	Ways	Price €	Unit/Box
388 0020	1"G	2		1/1
388 0021	1"G	3		1/1
388 0022	1"G	4		1/1
388 0023	1"G	5		1/1
388 0024	1"G	6		1/1
388 0025	1"G	7		1/1
388 0026	1"G	8		1/1
388 0027	1"G	9		1/1
388 0028	1"G	10		1/1
388 0029	1"G	11		1/1
388 0030	1"G	12		1/1
388 0053	1"G	13		1/1
388 0054	1"G	14		1/1

04_A COUPLE OF POLYAMIDE MANIFOLDS - 1"

DOUBLE CHAMBER

ACCESSORIES



2120R
Straight valve with reversible thermometer connection

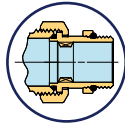

PATENTED

Code	Type	Price €	Unit/Box
	red handle		
212 0043	1"		5/20
	blue handle		
212 0042	1"		5/20



2121PTISOL
Insulation shell for 1" ball valve with thermometer holder

Code	Type	Price €	Unit/Box
557 0119	1"		1/12

DIMENSIONS

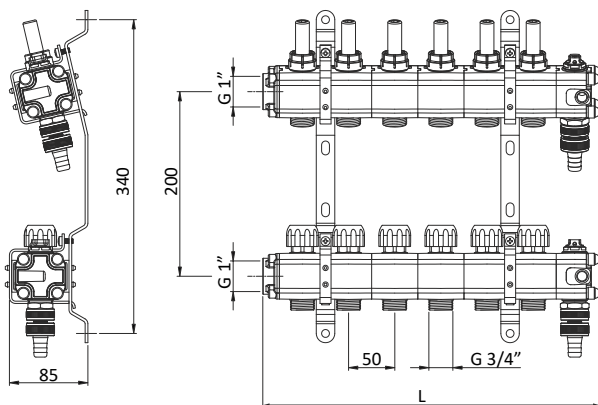

1939
Height and depth adjustable box for manifolds

 Adjustable depth from 90 mm to 140 mm

Code	Type	Price €	Unit/Box
181 0192	400 x 660 x 90 ÷ 140		1/1
181 0193	500 x 660 x 90 ÷ 140		1/1
181 0206	600 x 660 x 90 ÷ 140		1/1
181 0194	700 x 660 x 90 ÷ 140		1/1
181 0195	1000 x 660 x 90 ÷ 140		1/1

1939 DIMENSIONS

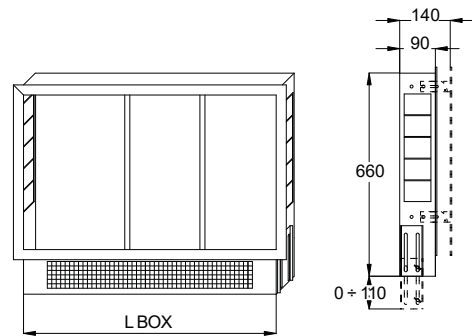

GUIDE TO THE CHOICE OF BOXES

MANIFOLD COMPATIBILITY: 3871POL

Ways No.	L* (mm)	L* + valvola (mm)	L BOX (mm)	Code
2	165	246	400	181 0192
3	215	296		
4	265	346	500	181 0193
5	315	396		
6	365	446	600	181 0206
7	415	496		
8	465	546	700	181 0194
9	515	596		
10	565	646	1000	181 0195
11	615	696		
12	665	746		
13	715	796		
14	765	846		

The size of the accessory ball valve has already been considered to define the manifold/ box combination.

* Manifold width

 For the complete range of accessories and spare parts see page 124



SINGLE CHAMBER

The distribution manifold art. 3871PMON is made of thermoplastic material with high technological content, designed for radiant heating and cooling systems.

These are manifolds complete with flowmeters with graduated scale and with the possibility of total closure of the way on the delivery module.

Each return module is equipped with a thermostat insert for the application of an electrothermal actuator (Art. 9568).

The 3/4" x 18 Eurocono outlets are perfectly compatible with both PEX and multilayer pipes.

To obtain these characteristics, high-tech thermoplastic materials have been used. In particular, the material constituting the modules is a polyamide reinforced with 50% fiberglass with mechanical characteristics similar to light alloys but with significantly higher resistance to atmospheric agents. Another essential feature of the manifolds is that it is absolutely impervious to limestone sediments and therefore the protection from any type of corrosion.

TECHNICAL CHARACTERISTICS

- Max percentage of glycol: 50%
- Maximum working pressure: 6 bar
- Temperature range: 5 °C ÷ 55 °C

MATERIALS

- Components made of plastic: PA12 / PA12 GF30/ PPS/ PA6,6/ PA6,6 GF30/ PP/ POM
- Brass components: CW614N/CW617N
- Gaskets: EPDM Perox

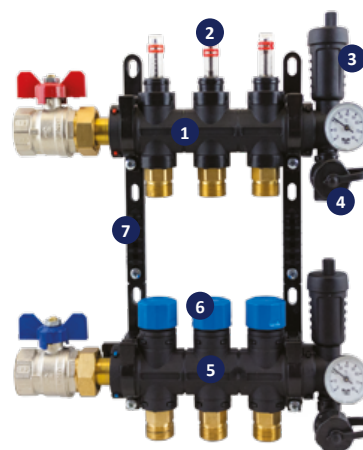

1. Delivery manifold
2. Flowmeters
3. Automatic vent valve
4. Loading and unloading valve
5. Return manifold
6. Thermostatic manual shut-off valves with protective cap
7. Fixing brackets

PRODUCT RANGE

NEW



3871PMON

1" distribution monoblock manifold in polyamide with 3/4"x18 outlets (Eurocono) and flowmeters

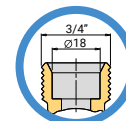

 Couple with servo control 9568.

Code	Type	Ways	Price €	Unit/Box
388 0031	1"G	2		1/1
388 0032	1"G	3		1/1
388 0033	1"G	4		1/1
388 0034	1"G	5		1/1
388 0035	1"G	6		1/1
388 0036	1"G	7		1/1
388 0037	1"G	8		1/1
388 0038	1"G	9		1/1
388 0039	1"G	10		1/1
388 0040	1"G	11		1/1
388 0041	1"G	12		1/1
388 0078	1"G	13		1/1
388 0080	1"G	14		1/1

04_A COUPLE OF POLYAMIDE MANIFOLDS - 1"

SINGLE CHAMBER

ACCESSORIES

NEW



3871KITPMON

2-way extension kit for 1" distribution monoblock manifold in polyamide with 3/4"x18 outlets (Eurocono) and flowmeters

i Couple with servo control 9568.

Code	Type	Ways	Price €	Unit/Box
388 0083	1"G	2		1/4

DIMENSIONS

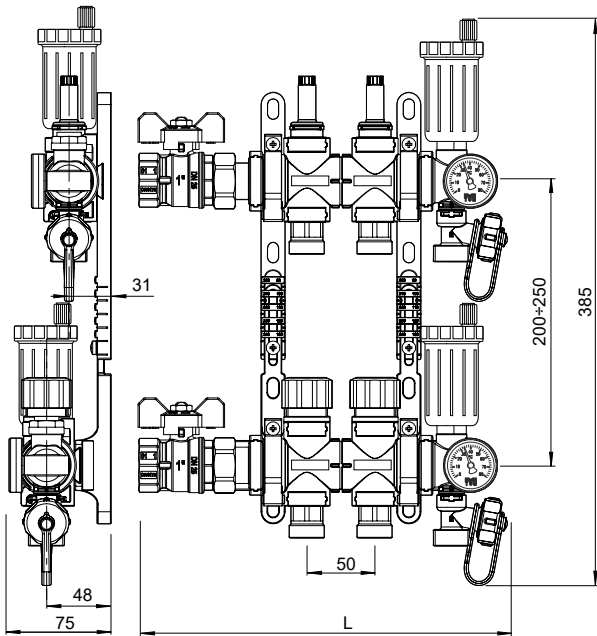

1939

Height and depth adjustable box for manifolds

i Adjustable depth from 90 mm to 140 mm

Code	Type	Price €	Unit/Box
181 0192	400 x 660 x 90 ÷ 140		1/1
181 0193	500 x 660 x 90 ÷ 140		1/1
181 0206	600 x 660 x 90 ÷ 140		1/1
181 0194	700 x 660 x 90 ÷ 140		1/1
181 0195	1000 x 660 x 90 ÷ 140		1/1

1939 DIMENSIONS

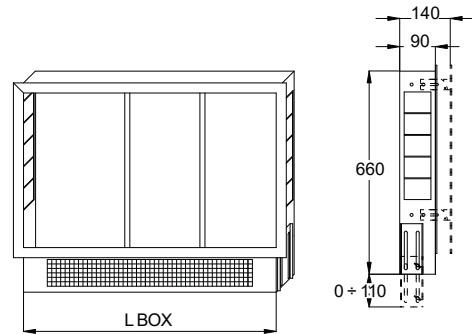

GUIDE TO THE CHOICE OF BOXES

MANIFOLD COMPATIBILITY: 3871PMON

Ways No.	L* (mm)	L BOX (mm)	Code
2	271	400	181 0192
3	321		
4	371	500	181 0193
5	421		
6	471	600	181 0206
7	521		
8	571	700	181 0194
9	621		
10	671	1000	181 0195
11	758		
12	808		
13	858		
14	908		

* Manifold width



Distribution manifolds art. 3872POL are made of thermoplastic material with high technological content, designed for radiant heating and cooling systems.

These are patented modular manifolds complete with flowmeters with graduated scale, with the possibility of total closure of the way on the delivery module.

Each return module is equipped with a thermostat insert for the application of an electrothermal actuator. The 3/4" x 18 Eurocono outlets are perfectly compatible with both PEX and multilayer pipes.

The low pressure drops (characteristic due to the particular shape of the delivery and return modules) allow the use of pipes for the heating circuits with a significantly reduced diameter.

To obtain these characteristics, high-tech thermoplastic materials have been used. In particular, the material constituting the modules is a polyamide reinforced with 50% fiberglass with mechanical characteristics similar to light alloys but with significantly higher resistance to atmospheric agents. Another essential feature of the manifolds is that it is absolutely impervious to limestone sediments and therefore the protection from any type of corrosion.

TECHNICAL CHARACTERISTICS

- Max percentage of glycol: 50%
- Operating pressure: 1,5 ÷ 2,5 bar
- Maximum working pressure: 6 bar
- Test pressure: 8 bar
- Temperature range: 4 °C ÷ 70 °C

DELIVERY MODULE MATERIALS

- Body: PAS777
- Partializer: PES
- Index of flow: POM
- Cap: CW614N
- Handle: ABS
- Cap cover: ABS
- O-ring: NBR

RETURN MODULES MATERIALS

- Body: PAS777
- Thermostatic block: CW614N
- Dipstick: AISI303
- Spring: AISI302
- Handle: ABS
- O-ring: NBR

HEAD/TERMINAL KIT MATERIALS

- Air vent/terminal body: PAS777
- Bracket/collar: PP
- Screws: C15
- Threaded bar: Fe37 galvanized CR3
- Brass components: CW617N
- Drain tap: PA6
- O-rings: NBR70

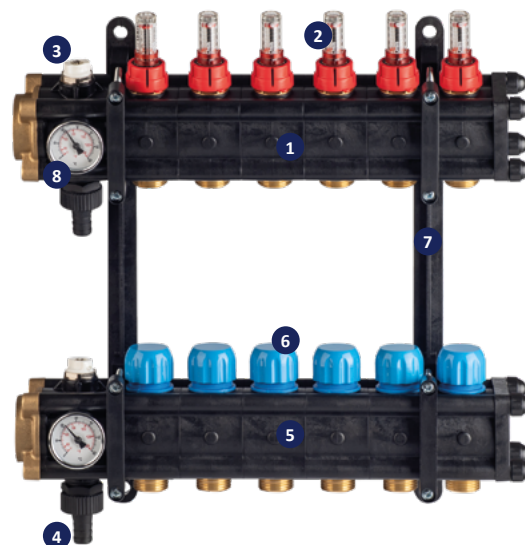

1. Delivery manifold
2. Flowmeters
3. Manual vent valve
4. Loading and unloading valve
5. Return manifold
6. Thermostatic manual shut-off valves with protective cap
7. Fixing brackets
8. Thermometer

PRODUCT RANGE

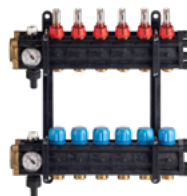

3872POL

1"1/4 polyamide distribution manifold with flowmeters

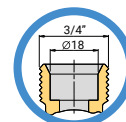

i Couple with servo control 9568.

Code	Type	Ways	Price €	Unit/Box
388 0007	1" 1/4G	2		1/1
388 0008	1" 1/4G	3		1/1
388 0009	1" 1/4G	4		1/1
388 0003	1" 1/4G	5		1/1
388 0004	1" 1/4G	6		1/1
388 0010	1" 1/4G	7		1/1
388 0011	1" 1/4G	8		1/1
388 0012	1" 1/4G	9		1/1
388 0005	1" 1/4G	10		1/1
388 0006	1" 1/4G	11		1/1
388 0001	1" 1/4G	12		1/1
388 0002	1" 1/4G	13		1/1
388 0013	1" 1/4G	14		1/1
388 0014	1" 1/4G	15		1/1
388 0015	1" 1/4G	16		1/1

ACCESSORIES



2371
MISTRAL ball valve Male/female
ISO 228 with T handle

Code	Type	Price €	Unit/Box
 red handle			
236 0031	1"1/4		8/32
 blue handle			
236 0138	1"1/4		8/32



2371ISOL
Insulation shell for MISTRAL ball
valve male/female 1"1/4

Code	Type	Price €	Unit/Box
557 0528	1"1/4		1/10

DIMENSIONS

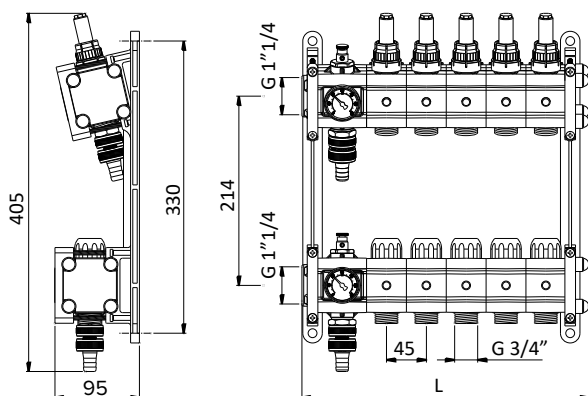

1940
Height and depth adjustable box
for mixing and distribution units
and manifolds

 Adjustable depth from 120 mm to 170 mm

Code	Type	Price €	Unit/Box
181 0020	600 x 670 x 120 ÷ 170		1/1
181 0016	700 x 670 x 120 ÷ 170		1/1
181 0015	850 x 670 x 120 ÷ 170		1/1
181 0019	1000 x 670 x 120 ÷ 170		1/1

1940 DIMENSIONS

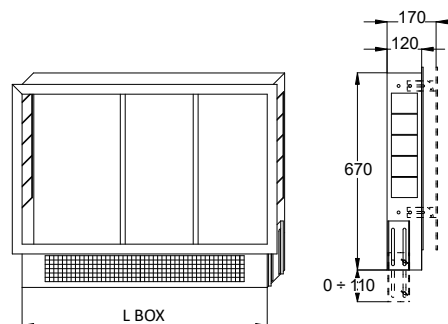

GUIDE TO THE CHOICE OF BOXES

MANIFOLD COMPATIBILITY: 3872POL

Ways No.	L' (mm)	L' + valvola (mm)	L BOX (mm)	Code
2	190	255	600	181 0020
3	235	300		
4	280	345		
5	325	390		
6	370	435	700	181 0016
7	415	480		
8	460	525		
9	505	570	850	181 0015
10	550	615		
11	595	660		
12	640	705		
13	685	750	1000	181 0019
14	730	795		
15	775	840		
16	820	885		

The size of the accessory ball valve has already been considered to define the manifold/ box combination.

* Manifold width

 For the complete range of accessories and spare parts see page 124



Distribution manifolds "INDUSTRIAL FLOOR", art. 3874, are the ideal solution for the construction of an industrial heating system.

They are available with 1"1/2 connections with male/female thread and with 5÷14 ways prepared with 1"x26,5 (internal diameter 1") connections.

The manifolds are supplied complete with shut-off valves, thermometer holding terminals with manual adjustable air vent valves and taps for loading and unloading the system.

The flow rate of each individual way is adjustable through a manual valve that also acts as a stop valve.

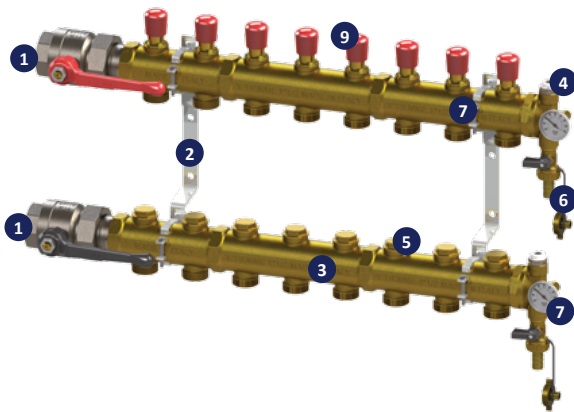

1. Full bore shut-off ball valve
2. Fixing brackets
3. Return manifold
4. Manual vent valve
5. Loading and unloading valve
6. Screw valves
7. Delivery manifold
8. Thermometer
9. Regulating screw valve

PRODUCT RANGE

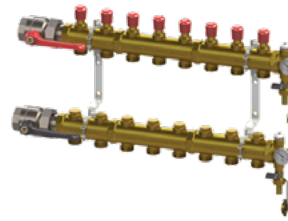

3874

1"1/2 distribution Forged manifold in brass CW617N with 1" male outlet

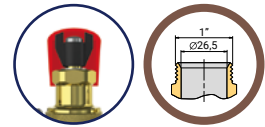

DESCRIPTION

- Supply and return manifold in brass CW617N
- 1" G outlet with regulating screw valve on the delivery
- 1"1/2 ball valves on adductions
- Thermometers
- Taps for loading/unloading
- Manual air vent valve
- Fixing brackets

Code	Type	Ways	Outlets	Price €	Unit/Box
385 0074	1"1/2G	5	1" G		1/1
385 0075	1"1/2G	6	1" G		1/1
385 0076	1"1/2G	7	1" G		1/1
385 0077	1"1/2G	8	1" G		1/1
385 0078	1"1/2G	9	1" G		1/1
385 0079	1"1/2G	10	1" G		1/1
385 0080	1"1/2G	11	1" G		1/1
385 0081	1"1/2G	12	1" G		1/1
385 0082	1"1/2G	13	1" G		1/1
385 0083	1"1/2G	14	1" G		1/1

3874

GUIDE TO CONNECTIONS

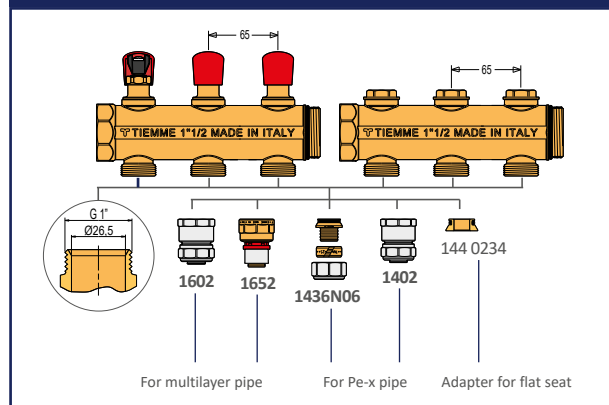

ACCESSORIES AND SPARE PARTS



1436N06
1" G adapter for PE-X pipe

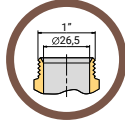

Code	Type	Price €	Unit/Box
144 0232	20 x 2,0 - 1" G		10/200
144 0075	25 x 2,3 - 1" G		10/200



1859
Adapter to transform 1" G connection into flat stop

Code	Type	Price €	Unit/Box
144 0234	1" G		10/300



3874P
Protective cap

Code	Type	Price €	Unit/Box
179 0037	-		5/50



1889TERMO
Female terminal fitting with thread self-aligning and thermometer holder

Code	Type	Price €	Unit/Box
195 0064	1"1/2 x 1/2" x 1/2"		5/50



3352
Manual vent valve with screwdriver cut

Code	Type	Price €	Unit/Box
198 0018	1/2"		10/500



2990G
BOILER ball cock for loading/unloading water

Code	Type	Price €	Unit/Box
295 0001	1/2"		25/100
295 0040	1/2"		10/50

Version with metal strap



9567KIT
INDUSTRIAL FLOOR adapter for electrothermal servo control 9567

Code	Type	Price €	Unit/Box
179 0328	-		1/100

9567-9567KIT ASSEMBLY INSTRUCTIONS

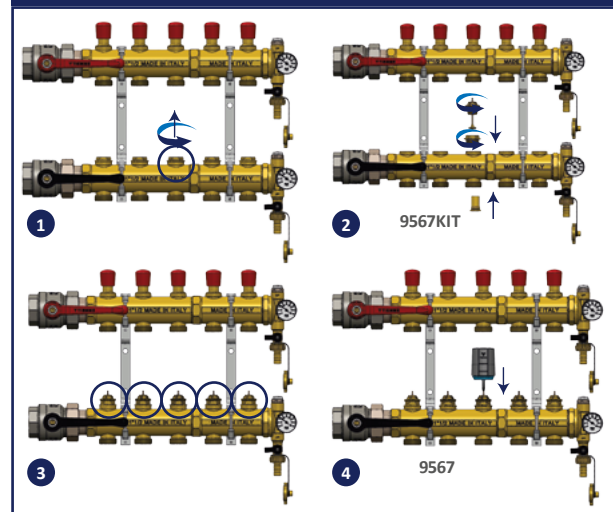

3874ISOL
Insulation shell for 1"1/2 distribution manifold

Code	Type	Price €	Unit/Box
557 0520	2 Ways		1/5
557 0522	3 Ways		1/5





1890ISOL
1"1/4 - 1"1/2 terminal group insulation shell and air vent valve

Code	Type	Price €	Unit/Box
557 0516	1"1/4 - 1"1/2		1/10



2121CPISOL
Insulation shell for 1"1/2 ball valve

Code	Type	Price €	Unit/Box
557 0518	1"1/2		1/10

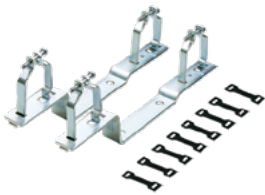

1865
Universal support for Forged manifolds INDUSTRIAL FLOOR

Code	Type	Price €	Unit/Box
181 0007	1"1/2		1/25

DIMENSIONS

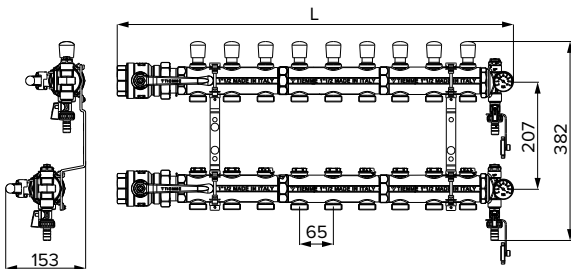

1941
External box for INDUSTRIAL FLOOR manifolds

Code	Type	Price €	Unit/Box
181 0110	900 x 650 x 170		1/1
181 0111	1200 x 650 x 170		1/1

1941 DIMENSIONS

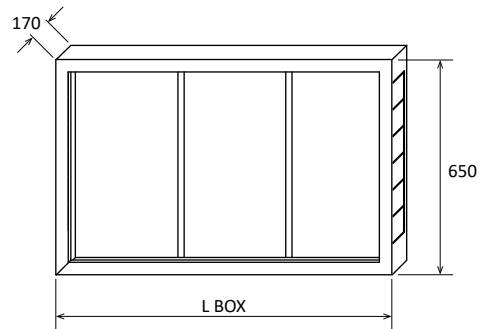

GUIDE TO THE CHOICE OF BOXES

MANIFOLD COMPATIBILITY: 3874

Ways No.	L* (mm)	L BOX (mm)	Code
5	495	900	181 0110
6	560		
7	625		
8	690		
9	755		
10	820	1200	181 0111
11	885		
12	950		
13	1015		
14	1080		

* Manifold width

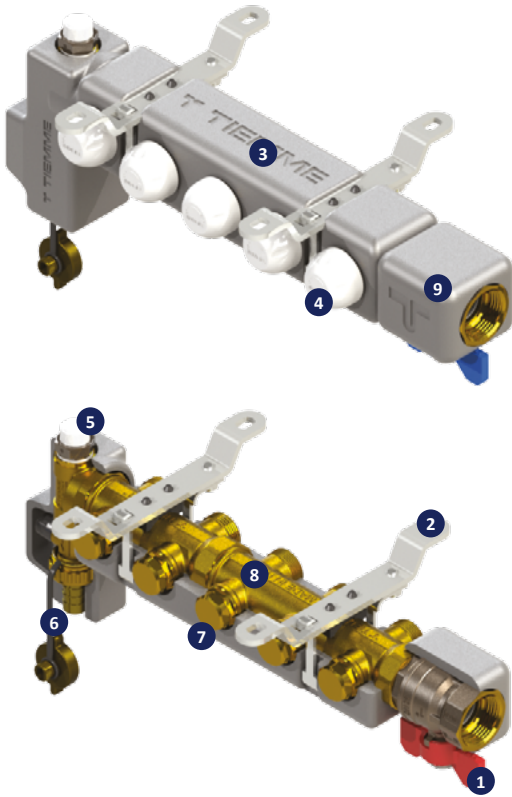

1. Full bore shut-off ball valve
2. Fixing brackets
3. Return manifold
4. Thermostatic manual shut-off valves (preset for regulation with electrothermal actuators) with protective cap
5. Manual vent valve
6. Loading and unloading valve
7. Screw valves with mechanical memory
8. Delivery manifold
9. Insulating shell

PRODUCT RANGE

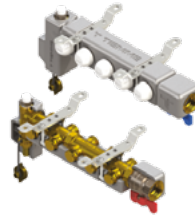

3878RS

1" distribution manifold with screw valves with mechanical memory and insulation shells. Ceiling-specific configuration and fixing systems

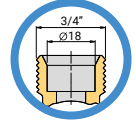

i Manifold for ceiling systems Tiemme CEILING

Code	Type	Ways	Price €	Unit/Box
557 0353	1"G	2		1/1
557 0354	1"G	3		1/1
557 0355	1"G	4		1/1
557 0356	1"G	5		1/1
557 0357	1"G	6		1/1
557 0358	1"G	7		1/1
557 0359	1"G	8		1/1
557 0360	1"G	9		1/1
557 0361	1"G	10		1/1
557 0362	1"G	11		1/1
557 0363	1"G	12		1/1



Pre-assembled mixing and distribution unit for radiant panel systems with fixed point regulation and offset manifolds.

The mixing and distribution unit art. 3868G is the simplest and most compact solution for the realization of a radiant panel heating system and combines perfectly with high temperature boilers. The thermostatic mixing unit mixes high temperature water with low temperature return water from radiant circuits. The temperature value of the thermal energy carrier fluid is maintained by a thermostatic actuator. Available with or without manifolds for high temperature terminals with 3/4" connections (Ø 18) Eurocono.

In full compliance with the European Directive 2009/125/CE (ErP) on energy saving, the unit comes with high efficiency pumps.

PRINCIPLE OF OPERATION

The high temperature water from the boiler (A) is mixed via the thermostatic valve (B) with the water coming from the return circuits of the floor system obtaining the delivery temperature of the floor heating system set on the thermostatic head (C) and controlled by immersion probe (E).

The pump (G), cut from the ball valves (F), favouring the mixing of fluids, ensures the hydraulic head in the circuits of the radiant panel. If the pre-set value is exceeded (55 °C) the safety thermostat (H) switches the pump off electrically.

The water mixed at the desired temperature is directed to the supply manifold (N) of the floor system. The lockshield valve (O) allows the balancing of the system by regulating the passage of water from the return manifold (D) and directed to the boiler (P).

A by-pass (R) always guarantees a minimum flow rate, safeguarding the circulation pump and reducing any noise problems. The unit is completed by the system load/unload valve (L) and the vent valve (M).

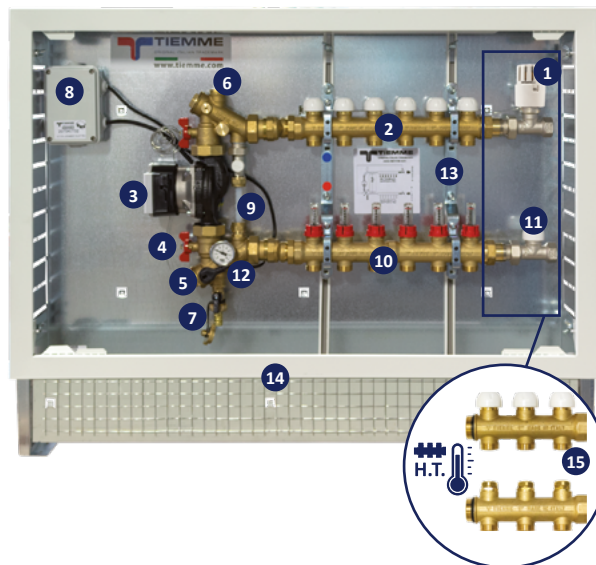
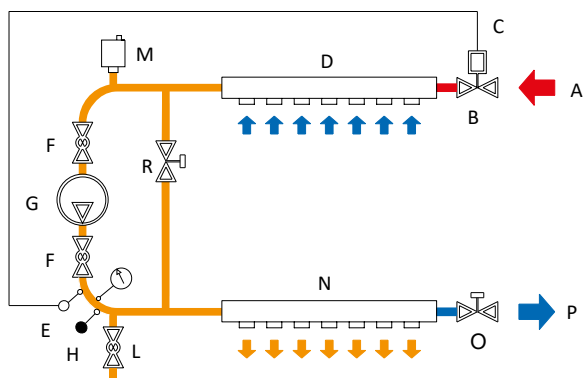

1. Fixed point mixing kit with thermostatic regulation (20 ÷ 50 °C)
2. Delivery 1" manifold complete with flowmeters
3. High Efficiency Circulating Pump
4. Shut-off ball valves
5. Safety thermostat
6. Air vent valve
7. Loading and unloading valve
8. Kit for the electrical connections
9. By-pass
10. Return 1" manifold complete with thermostatic manual shut-off valves
11. Lockshield valve
12. Thermometers
13. Steel brackets
14. Steel box
15. High temperature manifold

TECHNICAL CHARACTERISTICS

- Maximum fluid inlet temperature: 110 °C
- Maximum pressure: 10 bar
- Primary circuit connections: 3/4" F
- Distribution manifold material: Brass CW617N
- O-rings material: EPDM
- Adjustment range: 20 ÷ 50 °C
- Safety thermostat: preset 55 °C

PUMP

- Model: Wilo PARA 25/7
- Connections: 1" 1/2
- Connections centre distance: 130 mm

THERMOSTATIC HEAD

- Ferrule connection: M30 x 1,5
- Knob material: ABS

DIMENSIONS

See table on page 123



3868G

Mixing and distribution unit with fixed point regulation and by-pass

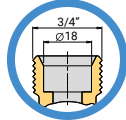

Code	Type	Ways	Price €	Unit/Box
391 0103	1"G	2		1/1
391 0110	1"G	3		1/1
391 0101	1"G	4		1/1
391 0098	1"G	5		1/1
391 0028	1"G	6		1/1
391 0077	1"G	7		1/1
391 0064	1"G	8		1/1
391 0111	1"G	9		1/1
391 0071	1"G	10		1/1
391 0059	1"G	11		1/1
391 0062	1"G	12		1/1



3868GHTPP3

Mixing and distribution unit with fixed point regulation, by-pass and high temperature 3-way kit

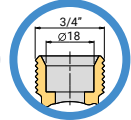

Code	Type	Ways	Price €	Unit/Box
391 0119	1"G	2		1/1
391 0120	1"G	3		1/1
391 0121	1"G	4		1/1
391 0122	1"G	5		1/1
391 0123	1"G	6		1/1
391 0124	1"G	7		1/1
391 0125	1"G	8		1/1
391 0126	1"G	9		1/1
391 0085	1"G	10		1/1
391 0127	1"G	11		1/1
391 0129	1"G	12		1/1



3868GHTPP2

Mixing and distribution unit with fixed point regulation, by-pass and high temperature 2-way kit

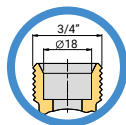

Code	Type	Ways	Price €	Unit/Box
391 0118	1"G	2		1/1
391 0097	1"G	3		1/1
391 0074	1"G	4		1/1
391 0036	1"G	5		1/1
391 0047	1"G	6		1/1
391 0029	1"G	7		1/1
391 0058	1"G	8		1/1
391 0052	1"G	9		1/1
391 0051	1"G	10		1/1
391 0061	1"G	11		1/1
391 0128	1"G	12		1/1



Pre-assembled mixing and distribution unit for radiant panel systems with fixed point regulation and offset manifolds. The mixing and distribution unit art. 3896PF is the solution traditionally based on a 3-way mixing valve that mixes the high temperature water from the boiler with the return water from the radiant system. The discharge temperature is set on the thermostatic head mounted on the same 3-way valve. Available with or without manifolds for high temperature terminals with 3/4" connections (Ø 18) Eurocono. In full compliance with the European Directive 2009/125/CE (ErP) on energy saving, the unit comes with high efficiency pumps.

PRINCIPLE OF OPERATION

The high temperature water from the boiler passes through the ball valve (A) and is mixed in the 3-way valve (C) with part of the water coming from the return manifold (I) of the floor system.

The temperature of the secondary circuit is maintained at the pre-set value by the thermostatic head (D) based on the temperature detected by the bulb temperature probe (F). The pump (E), favouring the mixing of fluids, ensures the hydraulic head in the circuits of the radiant panel.

The safety thermostat (G) intervenes electrically on the pump by turning it off if the preset value is exceeded (55 °C). The water mixed at the desired temperature is directed to the delivery (H) of the floor system. Low temperature water returning from panels (I) partly enters the valve (C) by mixing with water from the boiler and partly returns to the boiler via the ball valve (B). The check valve (L) prevents any high temperature water entering the radiant circuits. The bypass valve (M) allows the balancing of the system, always ensuring a minimum flow of the primary. High temperature circuits (heated towel rail) are fed through the points (O) and (N).

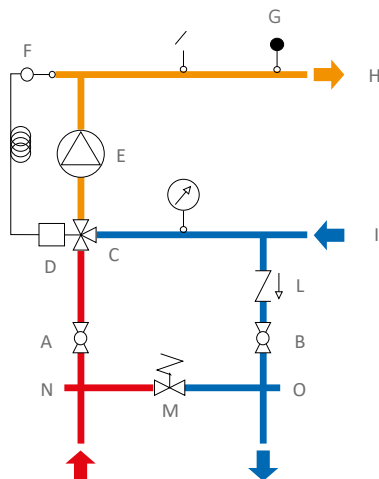

- | | | | |
|--|---------------------------|--|-------------------|
| | Thermostatic mixing valve | | Check valve |
| | High efficiency pump | | Temperature probe |
| | By-pass valve | | Safety thermostat |
| | Ball valve | | Thermometer |

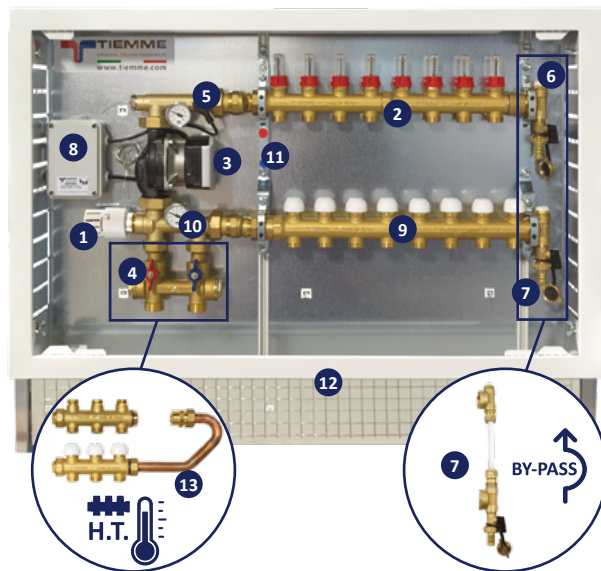

1. Fixed point mixing kit with thermostatic regulation (20 ÷ 50 °C)
2. Delivery 1" manifold complete with flowmeters
3. High Efficiency Circulating Pump
4. Shut-off ball valves
5. Safety thermostat
6. Air vent valve
7. Loading and unloading valve / Differential By-Pass
8. Kit for the electrical connections
9. Return 1" manifold complete with thermostatic manual shut-off valves
10. Thermometers
11. Steel brackets
12. Steel box
13. High temperature manifold

TECHNICAL CHARACTERISTICS

- Maximum fluid inlet temperature: 110 °C
- Maximum pressure: 10 bar
- Primary circuit connections: 1" M
- Distribution manifold material: Brass CW617N
- O-rings material: EPDM
- Adjustment range: 20 ÷ 50 °C
- Safety thermostat: preset 55 °C

PUMP

- Model: Wilo PARA 25/7
- Connections: 1" 1/2
- Connections centre distance: 130 mm

THERMOSTATIC HEAD

- Ferrule connection: M30 x 1,5
- Knob material: ABS

DIMENSIONS

See table on page 123

04_B FIXED POINT MIXING AND DISTRIBUTION UNITS - 1"

3896PF - 3896PFBYD - 3896PFHT - 3896PFHTBYD

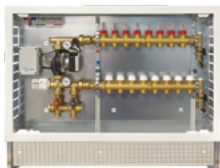

3896PF
Mixing and distribution unit
with fixed point regulation

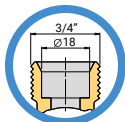

Code	Type	Ways	Price €	Unit/Box
390 0444	1"G	2		1/1
390 0445	1"G	3		1/1
390 0446	1"G	4		1/1
390 0447	1"G	5		1/1
390 0448	1"G	6		1/1
390 0449	1"G	7		1/1
390 0450	1"G	8		1/1
390 0451	1"G	9		1/1
390 0452	1"G	10		1/1
390 0453	1"G	11		1/1
390 0454	1"G	12		1/1

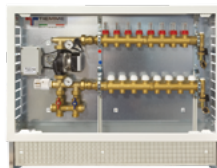

3896PFHT
Mixing and distribution unit
with fixed point regulation and
high temperature kit



Code	Type	Ways	Price €	Unit/Box
390 0488	1"G	2		1/1
390 0489	1"G	3		1/1
390 0490	1"G	4		1/1
390 0491	1"G	5		1/1
390 0492	1"G	6		1/1
390 0493	1"G	7		1/1
390 0494	1"G	8		1/1
390 0495	1"G	9		1/1
390 0496	1"G	10		1/1
390 0497	1"G	11		1/1
390 0498	1"G	12		1/1

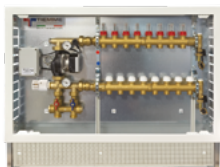

3896PFBYD
Mixing and distribution unit
with fixed point regulation and
differential by-pass

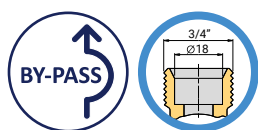

With Differential By-Pass

Code	Type	Ways	Price €	Unit/Box
390 0466	1"G	2		1/1
390 0467	1"G	3		1/1
390 0468	1"G	4		1/1
390 0469	1"G	5		1/1
390 0470	1"G	6		1/1
390 0471	1"G	7		1/1
390 0472	1"G	8		1/1
390 0473	1"G	9		1/1
390 0474	1"G	10		1/1
390 0475	1"G	11		1/1
390 0476	1"G	12		1/1

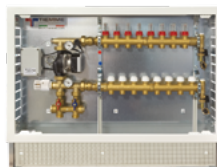

3896PFHTBYD
Mixing and distribution unit
with fixed point regulation,
differential by-pass and high
temperature kit



With Differential By-Pass

Code	Type	Ways	Price €	Unit/Box
390 0510	1"G	2		1/1
390 0511	1"G	3		1/1
390 0512	1"G	4		1/1
390 0513	1"G	5		1/1
390 0514	1"G	6		1/1
390 0515	1"G	7		1/1
390 0516	1"G	8		1/1
390 0517	1"G	9		1/1
390 0518	1"G	10		1/1
390 0519	1"G	11		1/1
390 0520	1"G	12		1/1



Mixing and distribution unit with climate control for heating and/or cooling systems with radiant panels.

Through the climate controlled mixing unit, the water from the calories/frigorics generator is mixed with the return water from the radiant circuits and kept constant at the desired value by a 0 ÷ 10 V servo motor operated by a control unit.

Available with or without manifolds for high temperature terminals with 3/4" connections (Ø 18) Eurocono.

In full compliance with the European Directive 2009/125/CE (ErP) on energy saving, the unit comes with high efficiency pumps.

PRINCIPLE OF OPERATION

The high temperature water from the boiler passes through the ball valve (A) and is mixed in the 3-way valve (C) with part of the water coming from the return manifold (I) of the floor system.

The temperature of the secondary circuit is maintained at the pre-set value by a 0 ÷ 10 V (D) servo motor operated by an optional control unit, based on the temperature detected by the NTC temperature probe (F). The pump (E), favouring the mixing of fluids, ensures the hydraulic head in the circuits of the radiant panel.

The safety thermostat (G) intervenes electrically on the pump by turning it off if the preset value is exceeded (55 °C). The water mixed at the desired temperature is directed to the delivery (H) of the floor system. Low temperature water returning from panels (I) partly enters the valve (C) by mixing with water from the boiler and partly returns to the boiler via the ball valve (B). The check valve (L) prevents any high temperature water entering the radiant circuits. The bypass valve (M) allows the balancing of the system, always ensuring a minimum flow of the primary. High temperature circuits (heated towel rails) are fed through the points (O) and (N).

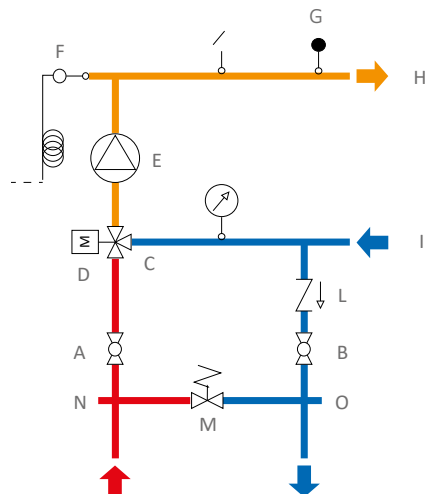

- | | | | |
|--|------------------------|--|-------------------|
| | Motorized mixing valve | | Check valve |
| | High efficiency pump | | Temperature probe |
| | By-pass valve | | Safety thermostat |
| | Ball valve | | Thermometer |

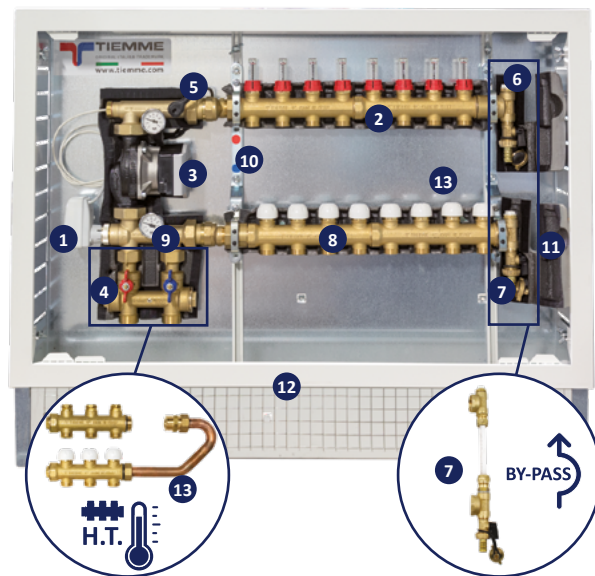

- Mixing kit for climate regulation (servo control 0 ÷ 10 V and NTC probe)
- Delivery 1" manifold complete with flowmeters or Screw valves with mechanical memory
- High Efficiency Circulating Pump
- Shut-off ball valves
- Safety thermostat
- Air vent valve
- Loading and unloading valve / Differential By-Pass
- Return 1" manifold complete with thermostatic manual shut-off valves
- Thermometers
- Steel brackets
- Insulating shell
- Steel box
- High temperature manifold

TECHNICAL CHARACTERISTICS

- Maximum fluid inlet temperature: 110 °C
- Maximum pressure: 10 bar
- Primary circuit connections: 1" M
- Distribution manifold material: Brass CW617N
- O-rings material: EPDM
- Adjustment range: 7 ÷ 50 °C
- Safety thermostat: preset 55 °C

PUMP

- Model: Wilo PARA 25/7
- Connections: 1" 1/2
- Connections centre distance: 130 mm

DIMENSIONS

See table on page 123

04_B CLIMATE CONTROL MIXING AND DISTRIBUTION UNITS - 1"

3896CL - 3896CLBYD - 3896CLHT - 3896CLHTBYD

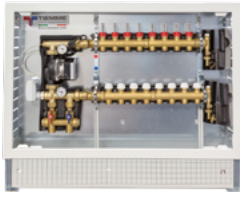

3896CL
Mixing and distribution unit
with climate control

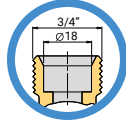

Code	Type	Ways	Price €	Unit/Box
390 0532	1"G	2		1/1
390 0533	1"G	3		1/1
390 0534	1"G	4		1/1
390 0535	1"G	5		1/1
390 0536	1"G	6		1/1
390 0537	1"G	7		1/1
390 0538	1"G	8		1/1
390 0539	1"G	9		1/1
390 0540	1"G	10		1/1
390 0541	1"G	11		1/1
390 0542	1"G	12		1/1

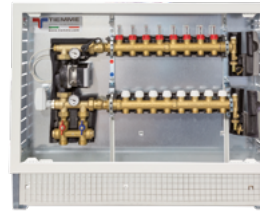

3896CLHT
Mixing and distribution unit
with climate control and high temperature kit

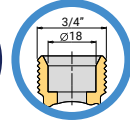

Code	Type	Ways	Price €	Unit/Box
390 0576	1"G	2		1/1
390 0577	1"G	3		1/1
390 0578	1"G	4		1/1
390 0579	1"G	5		1/1
390 0580	1"G	6		1/1
390 0581	1"G	7		1/1
390 0582	1"G	8		1/1
390 0583	1"G	9		1/1
390 0584	1"G	10		1/1
390 0585	1"G	11		1/1
390 0586	1"G	12		1/1

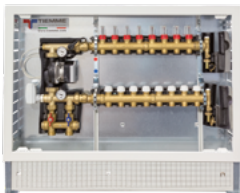

3896CLBYD
Mixing and distribution unit
with climate control and differential by-pass

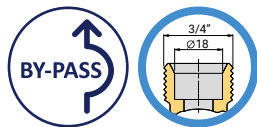

With Differential By-Pass

Code	Type	Ways	Price €	Unit/Box
390 0554	1"G	2		1/1
390 0555	1"G	3		1/1
390 0556	1"G	4		1/1
390 0557	1"G	5		1/1
390 0558	1"G	6		1/1
390 0559	1"G	7		1/1
390 0560	1"G	8		1/1
390 0561	1"G	9		1/1
390 0562	1"G	10		1/1
390 0563	1"G	11		1/1
390 0564	1"G	12		1/1

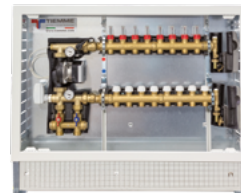

3896CLHTBYD
Mixing and distribution unit
with climate control, differential By-Pass and high temperature kit

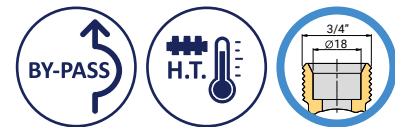

With Differential By-Pass

Code	Type	Ways	Price €	Unit/Box
390 0598	1"G	2		1/1
390 0599	1"G	3		1/1
390 0600	1"G	4		1/1
390 0601	1"G	5		1/1
390 0602	1"G	6		1/1
390 0603	1"G	7		1/1
390 0604	1"G	8		1/1
390 0605	1"G	9		1/1
390 0606	1"G	10		1/1
390 0607	1"G	11		1/1
390 0608	1"G	12		1/1



04_B MIXING AND DISTRIBUTION UNITS - 1"

**3868G - 3868GHTPP2
3868GHTPP3**

DIMENSIONS

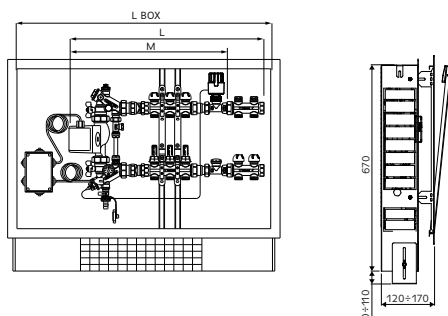

INGOMBRO KIT COLLETTORE - 3868G

Ways No.	2	3	4	5	6	7	8	9	10	11	12	
M (mm)	460	510	560	610	660	710	760	810	860	910	960	
L BOX (mm)	600		700			850			1000			1200

INGOMBRO KIT CON HIGH TEMPERATURE MANIFOLD 2 WAYS - 3868GHTPP2

Ways No.	2	3	4	5	6	7	8	9	10	11	12
M (mm)	580	630	680	730	780	830	880	930	980	1030	1080
L BOX (mm)	700		850			1000			1200		

INGOMBRO KIT CON HIGH TEMPERATURE MANIFOLD 3 WAYS - 3868GHTPP3

Ways No.	2	3	4	5	6	7	8	9	10	11	12
M (mm)	630	680	730	780	830	880	930	980	1030	1080	1130
L BOX (mm)	700	850			1000			1200			

**3896PF - 3896PFBYD
3896PFHT - 3896PFHTBYD**

DIMENSIONS

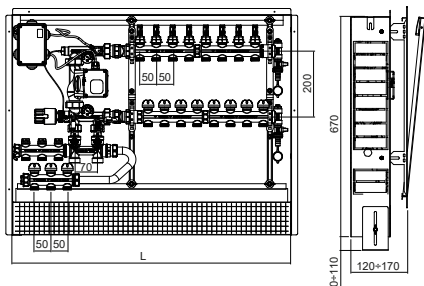

Ways No.	2	3	4	5	6	7	8	9	10	11	12
L (mm)	600	700	850	1000	1200						

**3896CL - 3896CLBYD
3896CLHT - 3896CLHTBYD**

DIMENSIONS

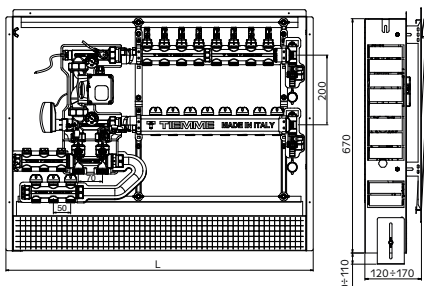

Ways No.	2	3	4	5	6	7	8	9	10	11	12
L (mm)	600	700	850	1000	1200						



1436N

Nickel-plated adapter for bodies with 3/4"x18 connection (EUROCONO) for PEX tube

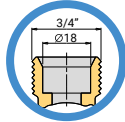

Code	Type	Price €	Unit/Box
144 0011	16 x 2,0 - 3/4" (ø18)		10/250
144 0012	17 x 2,0 - 3/4" (ø18)		10/200
144 0019	20 x 2,0 - 3/4" (ø18)		10/200



1636N

Nickel-plated adapter for bodies with 3/4"x18 connection (EUROCONO) for multilayer pipe



Code	Type	Price €	Unit/Box
144 0002	16 x 2,0 - 3/4" (ø18)		10/250
144 0003	20 x 2,0 - 3/4" (ø18)		10/200



9567

Electrothermal servo control with stroke indication

TECHNICAL CHARACTERISTICS

- Operating temperature: 24-230 Vac, 50/60 Hz
- Operating power: 1 W
- Switch-on current: max 550 mA for max 100 ms
- Stroke: 4 mm
- Class of protection: II
- Degree of protection: IP 54
- Ambient temperature: 0°C ÷ 60°C
- Storage temperature: -25°C ÷ 60°C

i Valve position normally closed in the absence of voltage

+ Equipped with "FIRST OPENING" function: it allows to facilitate the first installation operations on the manifold. For more details see the data sheet.

Code	Type	Price €	Unit/Box
450 0026	24V		1/20
450 0012	230V		1/20
450 0045	24V		1/20
450 0006	230V		1/20

Version with auxiliary micro switch



9568

Electrothermal servo control with stroke indication (per valvole termostattizzabili e collettore in poliammide art. 3872POL - 3871PMON)

TECHNICAL CHARACTERISTICS

- Operating temperature: 24-230 Vac, 50/60 Hz
- Operating power: 1 W
- Switch-on current: max 550 mA for max 100 ms
- Stroke: 4 mm
- Class of protection: II
- Degree of protection: IP 54
- Ambient temperature: 0°C ÷ 60°C
- Storage temperature: -25°C ÷ 60°C

i **COMBINE WITH MANIFOLD 3872POL AND 3871PMON**

i Valve position normally closed in the absence of voltage

+ Equipped with "FIRST OPENING" function: it allows to facilitate the first installation operations on the manifold. For more details see the data sheet.

Code	Type	Price €	Unit/Box
450 0543	24V		1/20
450 0539	230V		1/20
450 0545	24V		1/20
450 0541	230V		1/20

Version with auxiliary micro switch





9561KIT01

Thermostatic head with remote probe and well with 1/2" connection. Adjustment range 20-50 °C

Code	Type	Price €	Unit/Box
450 0032	20-50°C		1/10



2075KIT01

Bimetallic countertop safety thermostat with M4 fixing screw. Inside temperature 55 °C. Contact range (normally closed) 10A 250vac. Supplied with connection cable.

Code	Type	Price €	Unit/Box
450 0051	55°C		1/50



2075KIT02

Electrical connection kit for mixing unit, circulation pump management, auxiliary boiler contact or zone valve, inlet for room thermostat and safety thermostat

i Removable terminal block to facilitate the work of the installer

i Supplied complete with cables for connection of circulation pump and safety thermostat

Code	Type	Price €	Unit/Box
450 0063	120 x 80 x H60 mm		1/1



3887

Multifunctional ball valve for mixing and distribution unit

Code	Type	Price €	Unit/Box
450 0050	1"		2/6



3895KPF

Kit for adjustable fixed point regulation 20 ±50 °C



DESCRIPTION

- Thermostatic head with outer bulb and adjustment range 20 ±50 °C
- Bulb probe holding well
- Electrical connection box (pump and safety thermostat)

Code	Type	Price €	Unit/Box
450 0376	-		1/1



3890BV

Kit with shut-off valves, bypasses and connections for high temperature distribution

Code	Type	Price €	Unit/Box
450 0082	1"		1/10



3895KCL

Kit for heating and cooling



DESCRIPTION

- Servo control 0±10V NC powered to 24V
- Ø 6 dry mounting probe holding well
- Safety thermostat connection cable
- Temperature probe NTC 10K@25 °C, diameter 6 mm

Code	Type	Price €	Unit/Box
450 0377	-		1/1

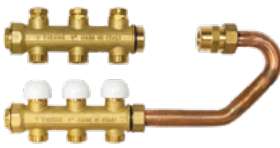

3895KHT

Kit for high temperature distribution

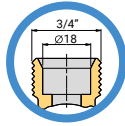

DESCRIPTION

- 1" 3 ways distribution brass manifolds with connections 3/4"x18 Eurocono and thermostatic screw valves
- 1" 3-way brass distribution manifolds with 3/4"x18 Eurocono connections and mechanical memory screw valves
- Connection fittings

Code	Type	Price €	Unit/Box
450 0378	1" 3 Ways		1/2



3890PW2

High efficiency circulation pump Wilo PARA 25/7 wheelbase 130 mm. Connection 1"1/2

+ HIGH EFFICIENCY PUMP

Code	Type	Price €	Unit/Box
450 0358	Wilo PARA 25/7		1/1



3889

1"1/2 pump connection with ball valve and 1" female connection

Code	Type	Pump connection	Price €	Unit/Box
450 0031	1"	1"1/2		2/40



3888

1"1/2 pump connection with ball valve and copper pipe connection

Code	Type	Pump connection	Price €	Unit/Box
450 0041	22	1"1/2		1/50
450 0044	28	1"1/2		1/50



1555SET

Brass male pump connection kit with flat seat

i Kit includes: 2 tangs, 2 rotating nuts, 2 gaskets

Code	Type	Pump connection	Price €	Unit/Box
150 0825	1/2"	3/4"		1/50
150 0826	3/4"	1"		1/50
150 0827	1"	1"1/4		1/25
150 0578	1"1/4	1"1/2		1/20



1557SET

Brass female pump connection kit with flat seat

i Kit includes: 2 tangs, 2 rotating nuts, 2 gaskets

Code	Type	Pump connection	Price €	Unit/Box
150 0906	1/2"	1"		1/50
150 0839	3/4"	1"1/4		1/25
150 0355	1"	1"1/2		1/20
150 0440	1"1/4	2"		1/10





H9709
FLOOR flowmeter for distribution manifold in Forged brass

Code	Type	Price €	Unit/Box
040 0196	-		5/100



H9708
Thermostatic screw valve for FLOOR Forged brass distribution manifold

Code	Type	Price €	Unit/Box
040 0241	-		10/50



2070
Ø 40 thermometer post connection L=30 mm scale 0 ÷ 80 °C

Code	Type	Price €	Unit/Box
179 0006	-		10/50



3352
Manual vent valve with screwdriver cut

Code	Type	Price €	Unit/Box
198 0018	1/2"		10/500



2990G
BOILER ball cock for loading/unloading water

Code	Type	Price €	Unit/Box
295 0001	1/2"		25/100
295 0040	1/2"		10/50

Version with metal strap



3049SKIT
Mounting kit for "FLOOR" Forged manifolds

Code	Type	Price €	Unit/Box
385 0063	1"		1/5

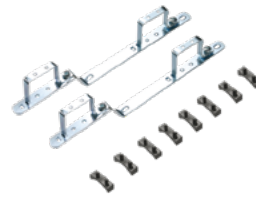

1863
"FLOOR" Forged manifold holder for box 1931-1939-1940

Code	Type	Price €	Unit/Box
181 0032	1"		1/25
181 0203	1"1/4		1/25

New code

05 HYDRAULIC SEPARATORS, DISTRIBUTION MANIFOLDS AND PUMPING STATIONS FOR HEATING SYSTEM

05A Introduction

Hydraulic power units for heating system	130
--	-----

05B Hydraulic separators and inertial storage

Hydraulic separators and inertial storage - Introduction	131
--	-----

Hydraulic separators in steel	 133
-------------------------------	---

Hydraulic separators in brass	 136
-------------------------------	---

Inertial accumulation	 138
-----------------------	---

05C Manifolds from heating systems

Steel manifolds	 139
-----------------	---

Modular manifolds in brass	 140
----------------------------	---

05D Pumping stations and adjustment units

Hydraulic power units DN25	 149
----------------------------	---

Hydraulic power units DN32	 154
----------------------------	---

Accessories	 156
-------------	---

05E Compact multi-zone distribution modules in box	 159
--	---

05F Biomass circulation and separation hydraulic power units	 162
--	---

A valid solution for the regulation and the distribution of the fluid inside the plant is the use of specific hydraulic mixing units for boiler room - also called heating system - associated with distribution manifolds.

In this chapter you will find a complete proposal for fluid management in the heating system:

- Steel and brass hydraulic separators for the hydraulic separation of the primary generation circuit from the secondary distribution circuit.
- Steel and brass manifolds for connecting the units to the generator;
- Hydraulic pumping stations, fixed point mixing and modulating mixing units

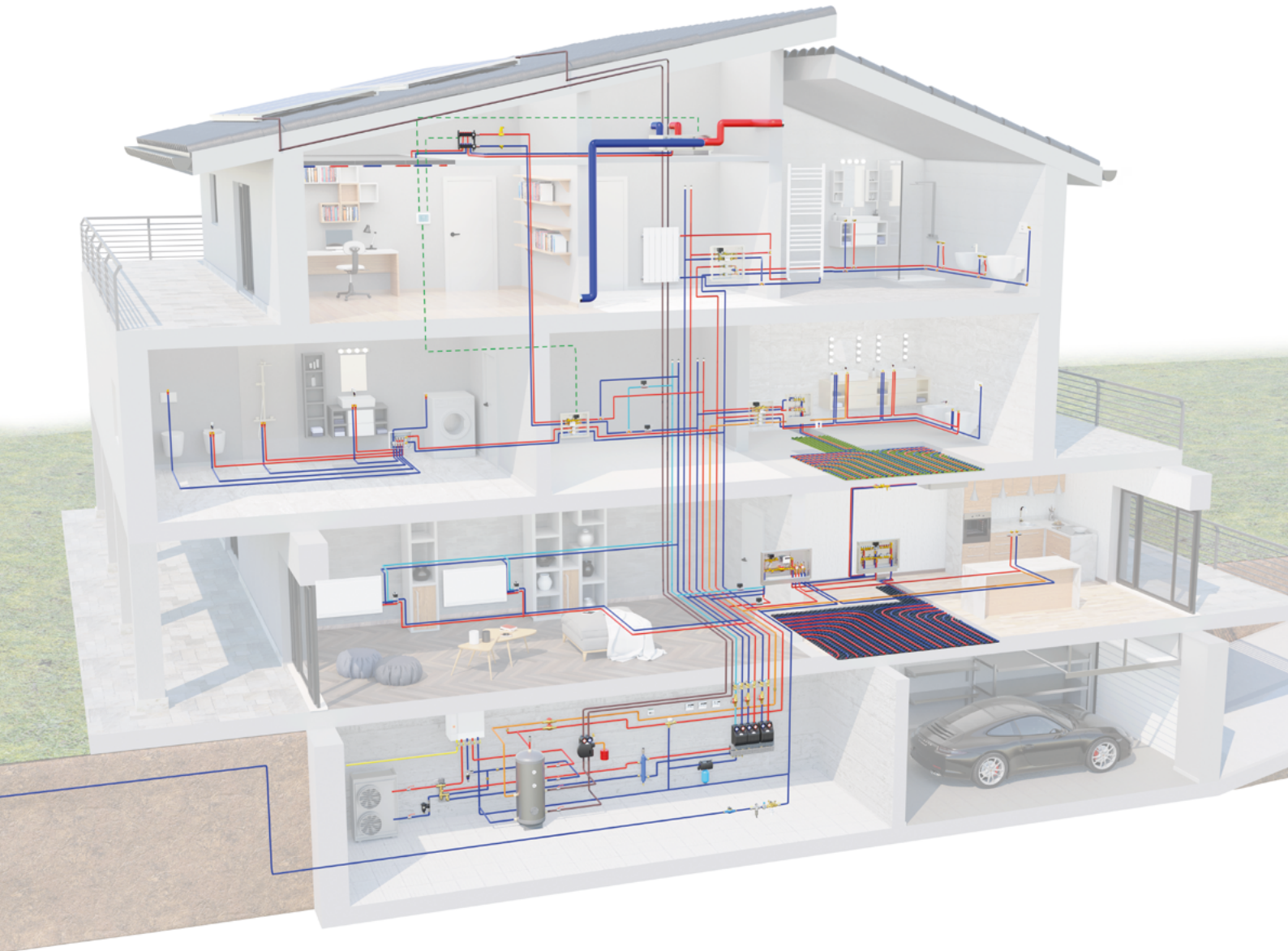

VIDEO TUTORIAL



Pumping stations



PRICE LIST

In systems that provide for a booster pump it is recommended to divide the primary circuit from the secondary one through a hydraulic circuit breaker. This can be done by means of a hydraulic separator (for systems with small volume) or by inertial accumulation.

Both are able to separate the two circuits (primary and secondary) as they consist of a zone with reduced pressure drops. Their function is to prevent that between the circuits themselves, due to changes in flow rates and the prevalences generated by circulation pumps, interference and disturbances may arise.

The choice of separator type is mainly influenced by the maximum flow rates in the plant.

CONDITIONS OF OPERATION

If the flow rates in the primary and secondary circuits are identical (condition 2), the hydraulic separator does not perform any function, while if one of the two currents has a flow rate higher than the other (condition 1 - 3), thanks to the hydraulic separator, a part of this flow rate is directed to the other flow, in order to balance the two flows.

This avoids interference between the pumps of the various circuits, improving the circulation of the fluid and ensuring for each single circuit connected to the operation at the design conditions.

The following is a graphical representation of the three hydraulic equilibrium conditions that we can find inside the separator:

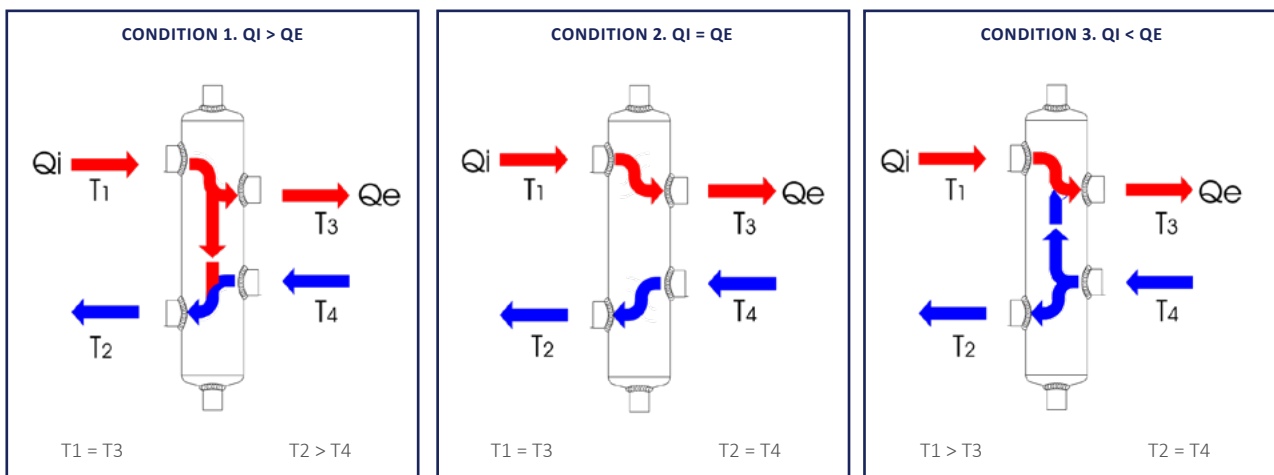

where:

Q_i = primary circuit flow rate

Q_e = secondary circuit flow rate

T_1 = Primary circuit delivery temperature

T_2 = Primary circuit return temperature

T_3 = Secondary circuit delivery temperature

T_4 = Secondary circuit return temperature

At the design stage, it is good practice to consider the possible temperature variations that the primary and secondary circuits may undergo due to their mixing inside the separator.

TIEMME INFORMS

Inertial accumulation shall be installed instead of a hydraulic separator in the following cases:

- to ensure the minimum water content (installations consisting mainly of fan coil units and radiators);
- to increase the thermal inertia of the plant in order to obtain a better control in modulation;
- where parallel installation of alternative heat sources to the heat pump is envisaged (e.g. pellet stove);
- to optimise operation during the defrosting process, avoiding cold water entering the system.

In the presence of a hydraulic separator or inertial accumulation it is essential to properly balance the flow rates of the primary and secondary circuits.

For all heat pump operations (heating, cooling, and defrosting) it is essential to ensure the minimum volume of water required, which must be met even in the most unfavourable conditions, that is, with totally or partially closed areas. To ensure a minimum volume of water to the heat pump it is possible to install an inertial accumulation, paying particular attention to its location and its sizing.

Inertial accumulation can be **connected as a hydraulic separator** between the primary and secondary circuits, making the two circuits hydraulically independent. This type of configuration guarantees an energy reserve for the users, therefore a greater inertia to the emission terminals in case of PdC shutdown. Alternatively, it can be **installed in line on the return of the system**, for example in systems without pumping circuit. On ON/OFF machines and on machines with obsolete inverters this arrangement allows to reduce the number of compressor cycles, ensuring less stress to the machine. The minimum return temperature of the water to the generator for the evaporator defrosting operations is guaranteed.

The inertial accumulation **placed on the delivery** plays the same function as a thermal flywheel on the return but, acting as an energy reserve for the emission system, requires more time to complete the phase of commissioning the system. Finally, it is possible to install the inertial accumulation in the three-pipe version: similar to the version as hydraulic separator, it allows to hydraulically compensate the circuits and at the same time provides an energy tank to serve users. The substantial difference is dictated by the presence of a direct connection from the machine to the users that allows a rapid commissioning.

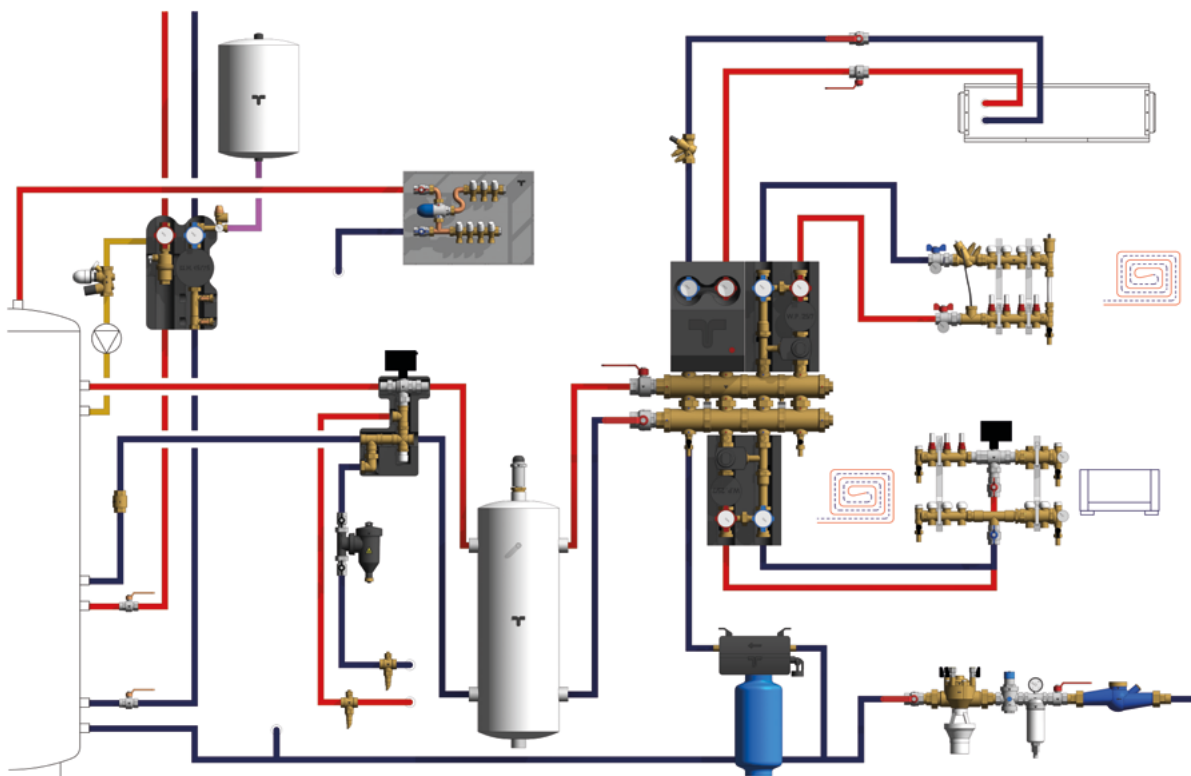

TIEMME INFORMS

The volume of inertial accumulation depends on the minimum volume of water required by the manufacturer of the PdC to ensure proper operation even in defrosting phases.

This value is influenced by the characteristics of the plant, its extension, and the management mode (presence of the By-pass valve) and must be guaranteed net of the water content of the heat pump and the emission system; In fact, with a 2-way zone regulation, the water content of the emission system is excluded from the total volume of the system when the ambient temperature is reached.

The minimum volume of water can be calculated according to the power of the machine: generally it can be assumed a value of 5÷7 litres per thermal Kw (in any case it is essential to follow the manufacturer's instructions).



ADVANTAGES / STRENGTHS

- Function of separator;
- Function of dirt separator;
- Available with or without insulation;
- Professional deaerator (art. 1896);
- Possibility to transform it into magnetic version by means of accessory 3144MAG (art. 3165 - art. 3165ISOL).



3165
Threaded hydraulic separator

TECHNICAL CHARACTERISTICS

- Body material: Fe 360 epoxy coated steel
- Max working pressure: 10 bar
- Max working temperature: 110°C

i Transformable in magnetic version with accessory 3144MAG.

Code	Type	Flow rate	Price €	Unit/Box
316 0006	1"	2,5 (m³/h)		1/1
316 0003	1"1/4	4,0 (m³/h)		1/1
316 0004	1"1/2	6,0 (m³/h)		1/1
316 0005	2"	9,0 (m³/h)		1/1



3165ISOL
Insulated threaded hydraulic separator

TECHNICAL CHARACTERISTICS

- Body material: Fe 360 epoxy coated steel
- Insulation material: PE-X closed cell foam
- Max working pressure: 10 bar
- Max working temperature: 100°C

i Transformable in magnetic version with accessory 3144MAG.

Code	Type	Flow rate	Price €	Unit/Box
316 0001	1"	2,5 (m³/h)		1/1
316 0002	1"1/4	4,0 (m³/h)		1/1
316 0008	1"1/2	6,0 (m³/h)		1/1
316 0007	2"	9,0 (m³/h)		1/1

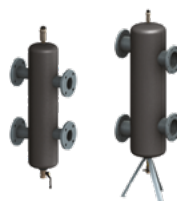

3167ISOL
Insulated flanged hydraulic separator

TECHNICAL CHARACTERISTICS

- Body material: Fe 360 steel
- Insulation material: PPE
- Max working pressure: 10 bar
- Max working temperature: 100°C

Code	Type	Flow rate	Price €	Unit/Box
316 0106	DN50	9 (m³/h)		1/1
316 0107	DN65	20 (m³/h)		1/1
316 0108	DN80	25 (m³/h)		1/1
316 0109	DN100	40 (m³/h)		1/1
316 0110	DN125	65 (m³/h)		1/1
316 0111	DN150	95 (m³/h)		1/1

Equipped with base for floor support

ADVANTAGES / STRENGTHS

- Function of separator
- Function of dirt separator
- Magnetic function
- Available with or without insulation
- Professional deaerator (art. 1896)



3144

Threaded magnetic hydraulic separator



TECHNICAL CHARACTERISTICS

- Body material: Fe 360 epoxy coated steel
- Max working pressure: 10 bar
- Max working temperature: 110°C

Code	Type	Flow rate	Price €	Unit/Box
314 0001	1"	2,5 (m³/h)		1/1
314 0002	1"1/4	4,0 (m³/h)		1/1
314 0003	1"1/2	6,0 (m³/h)		1/1
314 0004	2"	9,0 (m³/h)		1/1



3144ISOL

Insulated threaded magnetic hydraulic separator



TECHNICAL CHARACTERISTICS

- Body material: Fe 360 epoxy coated steel
- Insulation material: PE-X closed cell foam
- Max working pressure: 10 bar
- Max working temperature: 100°C

Code	Type	Flow rate	Price €	Unit/Box
314 0005	1"	2,5 (m³/h)		1/1
314 0006	1"1/4	4,0 (m³/h)		1/1
314 0007	1"1/2	6,0 (m³/h)		1/1
314 0008	2"	9,0 (m³/h)		1/1

ACCESSORIES AND SPARE PARTS



3144MAG

Well kit with magnet



Code	Type	Price €	Unit/Box
316 0105	1/2"		1/25



COMPONENT DESCRIPTION

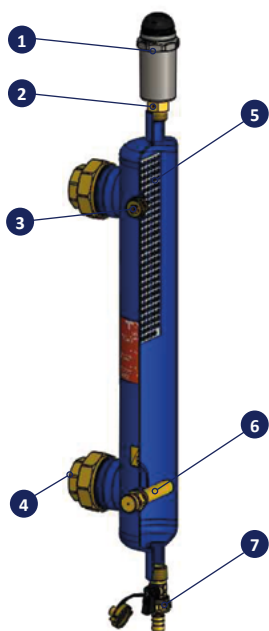

1. **Automatic air vent valve:** eliminates the air in the system.
2. **Cut-off and shut-off valve:** it allows maintenance/replacement of the air vent valve without having to empty the system.
3. **Threaded connection G 1/2" (supplied plugged):**
(art. 3144 - 3144ISOL - 3165 - 3165ISOL)
allows the installation of a probe-holder well (art. 9561T) in order to monitor the temperature of the delivery fluid.
4. **Flat seat fittings in 3 pieces:**
(art. 3144 - 3144ISOL - 3165 - 3165ISOL)
facilitate the installation of the separator.
5. **Metal mesh:** promotes the separation of impurities and the conveying of air bubbles to the air vent valve located at the upper end of the separator.
6. **Magnet 12.000 Gauss:**
(art. 3144 - 3144ISOL)
positioned at the bottom of the device, it allows to increase the filtration efficiency, blocking all ferrous impurities present inside the plant, through the action of the magnetic field.
7. **Loading/unloading valve:** useful both for carrying out the loading operations of the plant and for the elimination of sediments deposited inside the separator.

DIMENSIONS

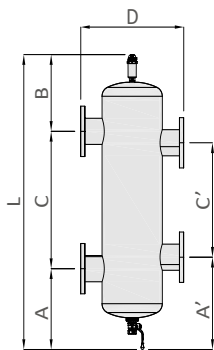
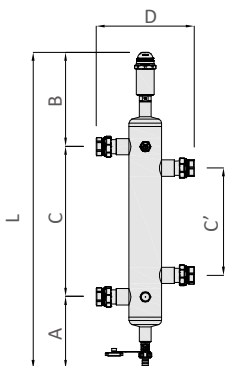

*Equipped with base for floor support

Art.	Code	Size	A (mm)	A' (mm)	B (mm)	C (mm)	C' (mm)	D (mm)	L (mm)	Volume (litres)
3165	316 0006	G 1" F	165	215	220	350	250	229	735	1,9
	316 0003	G 1"1/4 F	165	215	220	350	250	269	735	2,65
	316 0004	G 1"1/2 F	190	240	245	500	400	320	935	6
	316 0005	G 2" F	190	240	245	650	550	338	1085	11,5
3165ISOL	316 0001	G 1" F	165	215	220	350	250	229	735	1,9
	316 0002	G 1"1/4 F	165	215	220	350	250	269	735	2,65
	316 0008	G 1"1/2 F	190	240	245	500	400	320	935	6
	316 0007	G 2" F	190	240	245	650	550	338	1085	11,5
3144	314 0001	G 1" F	165	215	220	350	250	229	735	1,9
	314 0002	G 1"1/4 F	165	215	220	350	250	269	735	2,65
	314 0003	G 1"1/2 F	190	240	245	500	400	320	935	6
	314 0004	G 2" F	190	240	245	650	550	338	1085	11,5
3144ISOL	314 0005	G 1" F	165	215	220	350	250	229	735	1,9
	314 0006	G 1"1/4 F	165	215	220	350	250	269	735	2,65
	314 0007	G 1"1/2 F	190	240	245	500	400	320	935	6
	314 0008	G 2" F	190	240	245	650	550	338	1085	11,5
3167ISOL	316 0106	DN50	340	365	320	320	270	350	980	11
	316 0107	DN65	350	375	335	400	350	400	1085	18
	316 0108	DN80	350	400	335	500	400	500	1185	34
	316 0109	DN100	350	400	335	600	500	520	1285	60
	*316 0110	DN125	575	650	335	750	600	520	1660	68
	*316 0111	DN150	580	655	340	1000	850	600	1920	140

ADVANTAGES / STRENGTHS

- Extremely compact;
- Can be combined with Tiemme brass central manifolds;
- Equipped with insulation system;
- Version available with integrated shut-off valves (art. 7167).

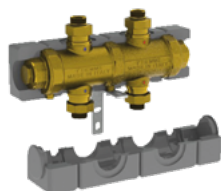

7166
Hydraulic separator with insulation

TECHNICAL CHARACTERISTICS

- Max working temperature: 100 °C
- Max working pressure: 10 bar
- Body and components: Brass CW617N
- Connections and outlets: 1" male thread
- Brackets: Galvanized steel
- Insulation shell: Closed cell expanded cross-linked polyethylene (PEX)
- Centre distance: 125 mm

Code	Section	Flow rate	Price €	Unit/Box
316 0050	1"	2,5 (m³/h)		1/1

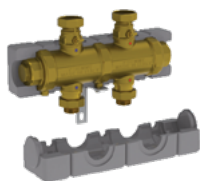

7167
Hydraulic separator with insulation and valves

TECHNICAL CHARACTERISTICS

- Max working temperature: 100 °C
- Max working pressure: 10 bar
- Body and components: Brass CW617N
- Connections and outlets: 1" male thread
- Brackets: Galvanized steel
- Insulation shell: Closed cell expanded cross-linked polyethylene (PEX)
- Centre distance: 125 mm

Code	Section	Flow rate	Price €	Unit/Box
316 0065	1"	2,5 (m³/h)		1/1

7166 DIMENSIONS

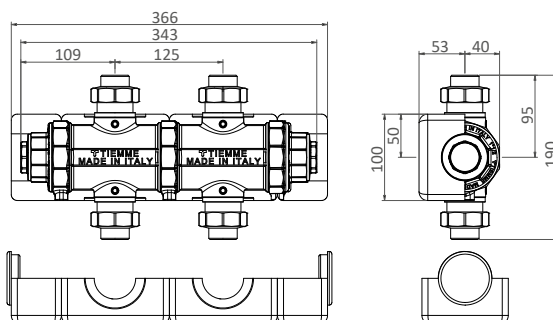

7167 DIMENSIONS

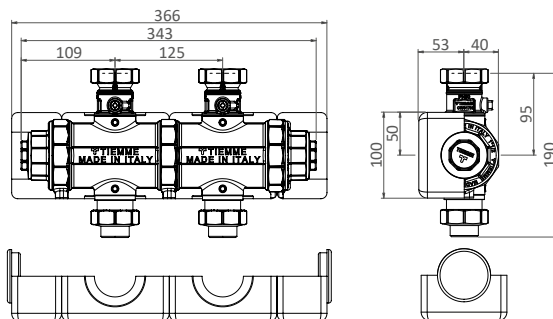

PRICE LIST

OPERATION

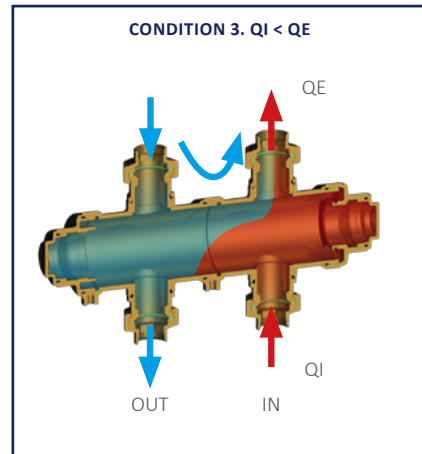
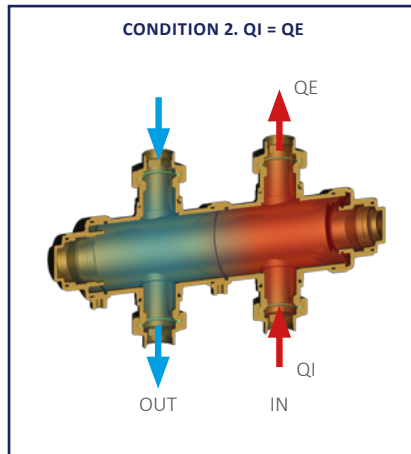
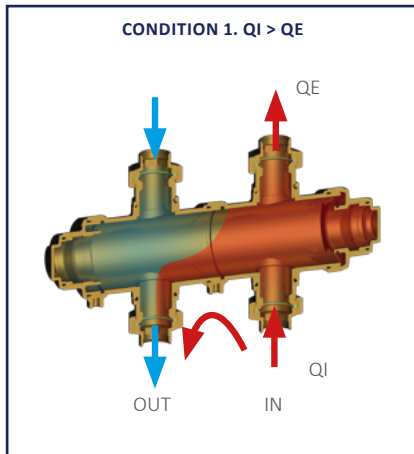

Q_I : primary circuit flow rate
 Q_E : secondary circuit flow rate

CONFIGURATION EXAMPLES

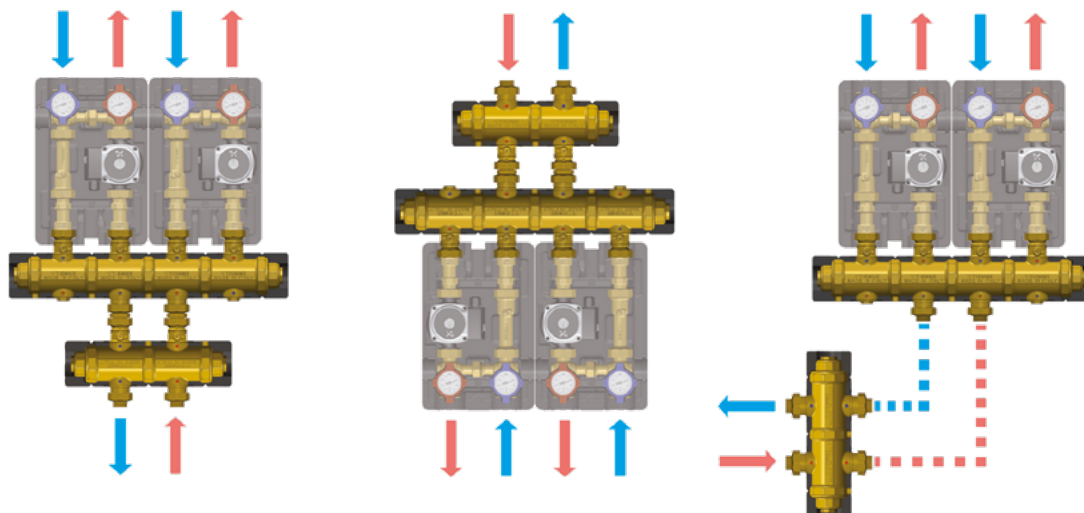

PRODUCT RANGE

NEW



3168

Inertial accumulation in stainless steel with function of hydraulic separator in combination with systems with heat pump.

Complete with air vent valve and M/F reduction.

Code	Type	Price €	Unit/Box
316 0154	25 Litres		1/1
316 0155	30 Litres		1/1
316 0156	50 Litres		1/1
316 0157	75 Litres		1/1

ACCESSORIES

NEW



3168ISOLIM

Thermal insulation made with PPE shells minimum thickness 45 mm and density 30 g/l.

Code	Type	Price €	Unit/Box
316 0162	Storage 25 Litres		1/1
316 0163	Storage 30 Litres		1/1
316 0164	Storage 50 Litres		1/1
316 0165	Storage 75 Litres		1/1

DIMENSIONAL CHARACTERISTICS

		Codes			
		316 0154	316 0155	316 0156	316 0157
Total width (A)	mm	333	333	333	333
Tank diameter (D)	mm	273	273	273	273
Height (H)	mm	400 (±5)	500 (±5)	800 (±5)	1250 (±5)
Total connections height (H1)	mm	460 (±5)	560 (±5)	860 (±5)	1310 (±5)
Distance between connections (I)	mm	180	250	500	650
Tank thickness (S)	mm	3	3	3	3
Straight nipples (M)	N°	6	6	6	6
Straight nipples connection threads		G 1"	G 1"	G 1" 1/4	G 1" 1/4
Straight nipples thread length (F)	mm	25	25	20	20
Temperature probe connection		G 1/4"	G 1/4"	G 1/4"	G 1/4"
Weight (without load)	Kg	9,67	11,63	17,81	26,63

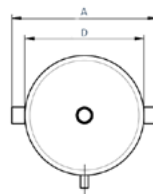
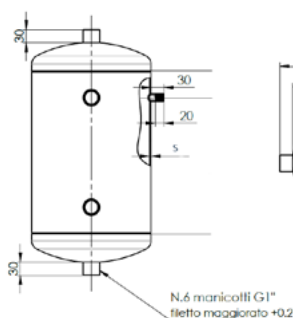
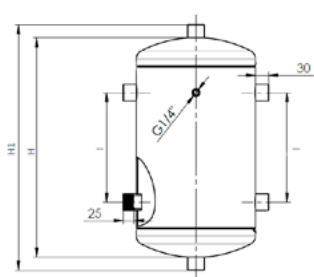

TECHNICAL CHARACTERISTICS

		316 0154	316 0155	316 0156	316 0157
Total capacity	Litres	25	30	50	75
Maximum working pressure	Bar	6	6	6	6
Maximum flow rate	m ³ /h	3,5	3,5	5,5	5,5
Dispersion	W	22	28	27	32
Working temperatures	°C	-10 ÷ +95			
Maximum percentage of Glycol	%	30			



Tiemme offers a series of extremely compact manifolds in steel that can be combined with different pumping stations to meet any plant requirements. Used in heating and/or air conditioning systems allow different thermal adjustments of the various environments with the presence of a single heat generator or refrigeration machine resulting in an easy to install and compact solution. Equipped with an insulating shell and available to power up to 4 or 6 circuits depending on the model chosen, they are characterized by 1"1/2 outlet connections with flat seat and 125mm circuit centre distance. Tiemme offers the choice of a manifold with integrated hydraulic separator, art. 5539X, all to the advantage of the simplicity of installation and the safeguarding of the useful living spaces. Tiemme compact steel manifolds art. 5538X - 5540X - 5539X, are supplied complete with preformed shell insulation to guarantee the perfect thermal insulation both in the use for heating and air conditioning systems.



5539X
Insulated steel hydraulic/
manifold separator and fixing
brackets, circuit centre distance
125 mm, connections with flat
seat and 1"1/2 cap



Code	Section	Circuits No.	Flow rate	Price €	Unit/Box
557 0001	80 x 80	2	3,0 (m³/h)		1/1
557 0002	80 x 80	3	3,0 (m³/h)		1/1
557 0003	120 x 120	2	7,0 (m³/h)		1/1
557 0004	120 x 120	3	7,0 (m³/h)		1/1
557 0005	120 x 120	4	7,0 (m³/h)		1/1

5539X

OPERATION

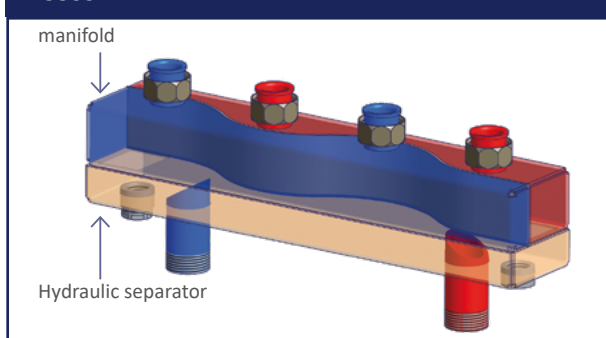

5538X 5540X

Steel manifold with insulation and fixing brackets, circuit centre distance 125 mm, connections with flat seat and 1"1/2 cap



Code	Section	Circuits No.	Flow rate	Price €	Unit/Box
557 0006	80 x 60	2	3,0 (m³/h)		1/1
557 0007	80 x 60	3	3,0 (m³/h)		1/1
557 0008	120 x 80	3	6,5 (m³/h)		1/1
557 0009	120 x 80	4	6,5 (m³/h)		1/1
557 0010	120 x 80	5	6,5 (m³/h)		1/1
557 0366	120 x 80	6	6,5 (m³/h)		1/1



5540X

Pair of soundproof and galvanized floor shelves

i Accessory for section manifold 120x80

Code	Type	Price €	Unit/Box
557 0011	h= 405-600 mm		1/1

The brass modular manifolds from Tiemme Heating System are the result of an internal project of the company, which wanted to create a unique and extremely versatile component to be proposed to its customers.

H.S. manifolds are used in air conditioning systems where a thermal/cooling operating sector is required in different environments. The heat generator (boiler, fireplace, etc...) or heat pump represent the primary circuit equipped with its own circulator, while on the distribution manifold from H.S. will be installed, depending on the necessary ways, secondary circuits that also have their own circulator. This cohesion, between primary circuit and secondary circuit/s, in the operating conditions, generates abnormal interference, characterized by variations in the flow and prevalence of the individual secondary circuits, as two, or more, circulators can never be installed in line. Therefore, a hydraulic separator must be placed between the primary and secondary circuits (characterized by the presence of the branching manifold) in such a way that the two circuits, primary and secondary, will work separately without generating operating anomalies.

OPERATION

The Tiemme brass manifold comes in two configurations: Art. 5538G, for a nominal flow of 2.2 m³/h (up to a maximum of 3 m³/h) with a characteristic coaxial shape (pipe in the pipe).

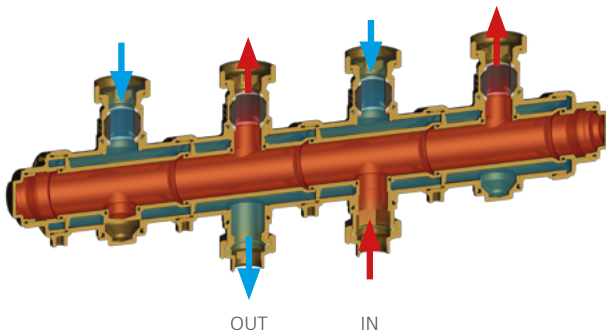

Art. 5540G, for a nominal flow of 6.5 m³/h (up to a maximum of 10 m³/h).

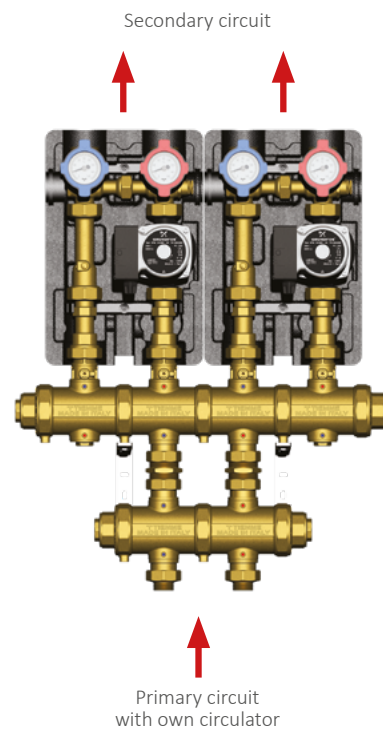
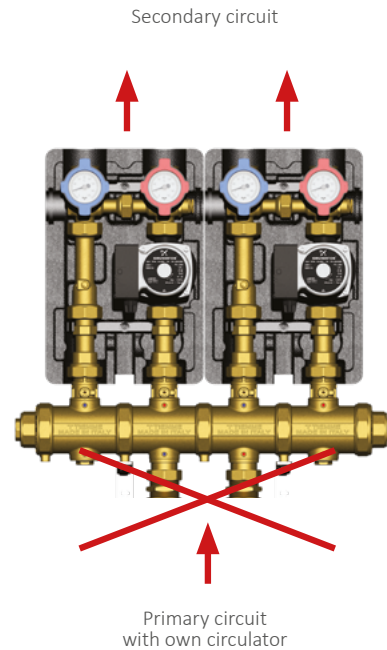
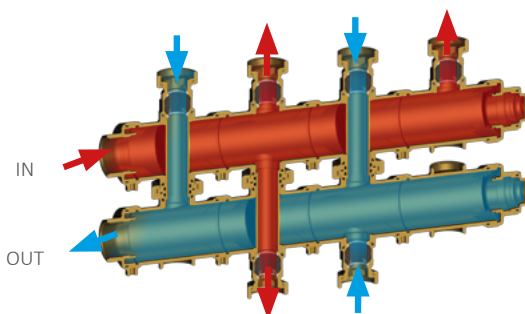

ADVANTAGES / STRENGTHS

Tiemme 5538G and 5540G brass manifolds have been designed to offer countless advantages to the installer including:

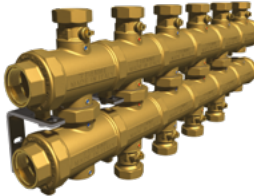

Easy installation

Installation is carried out by means of special wall fixing brackets (supplied) on which the collector is firmly anchored by means of screws



Ball valve

Specially designed to optimize installation and maintenance work on the manifold



Compactness

The possibility to install the pumping stations/mixing units (5535) facing both upwards and downwards to ensure greater compactness and flexibility of configuration



Insulation

The product is equipped with insulation shell for heating and air conditioning



Modularity

The manifold can be assembled in the configurations present in the catalogue or on customer specification

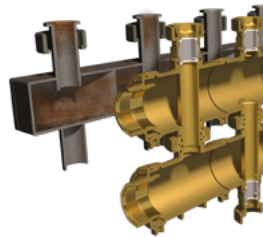

Longevity

The product is entirely made of brass and therefore guarantees a significant improvement of cleaning of the plant reducing the formation of rust. However, an appropriate bactericidal/fungicidal product should be used

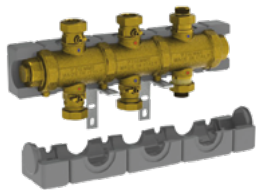

5538G2M3

Modular brass manifold for thermal plant complete with ball valves, insulation and fixing brackets. Centre distance 125 mm, flat seat connections and 1"1/2 idle nut

Code	Section	Circuits No.	Flow rate	Price €	Unit/Box
557 0368	2"1/2	2	2,2 (m³/h)		1/1
557 0483	2" 1/2	2	2,2 (m³/h)		1/1

5538G2M3

CONFIGURATION EXAMPLES

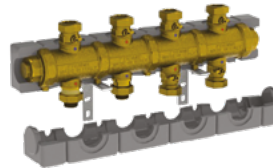
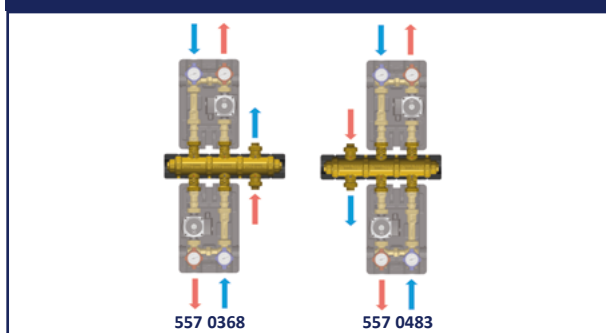

5538G3M4

Modular brass manifold for thermal plant complete with ball valves, insulation and fixing brackets. Centre distance 125 mm, flat seat connections and 1"1/2 idle nut

Code	Section	Circuits No.	Flow rate	Price €	Unit/Box
557 0370	2"1/2	3	2,2 (m³/h)		1/1
557 0486	2" 1/2	3	2,2 (m³/h)		1/1

5538G3M4

CONFIGURATION EXAMPLES

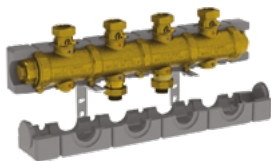
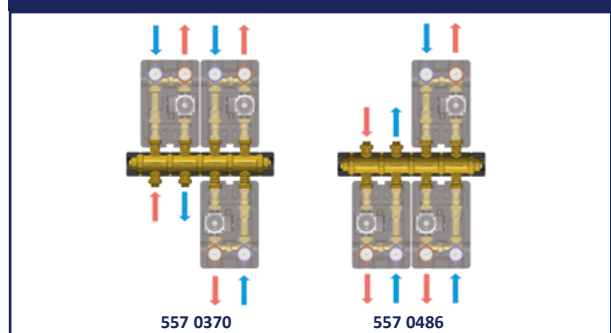

5538G2M4

Modular brass manifold for thermal plant complete with ball valves, insulation and fixing brackets. Centre distance 125 mm, flat seat connections and 1"1/2 idle nut

Code	Section	Circuits No.	Flow rate	Price €	Unit/Box
557 0369	2"1/2	2	2,2 (m³/h)		1/1
557 0484	2" 1/2	2	2,2 (m³/h)		1/1
557 0485	2" 1/2	2	2,2 (m³/h)		1/1

5538G2M4

CONFIGURATION EXAMPLES

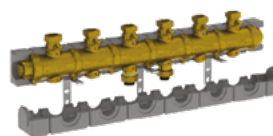
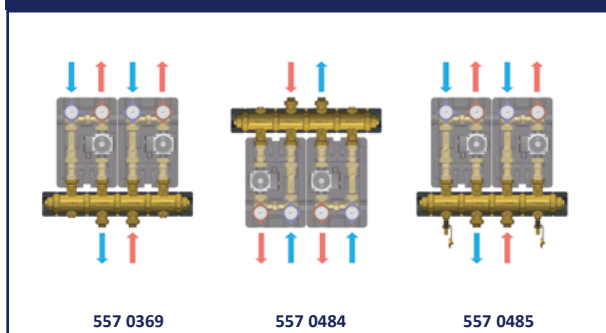

5538G3M6

Modular brass manifold for thermal plant complete with ball valves, insulation and fixing brackets. Centre distance 125 mm, flat seat connections and 1"1/2 idle nut

Code	Section	Circuits No.	Flow rate	Price €	Unit/Box
557 0371	2"1/2	3	2,2 (m³/h)		1/1
557 0487	2" 1/2	3	2,2 (m³/h)		1/1
557 0488	2" 1/2	3	2,2 (m³/h)		1/1

5538G3M6

CONFIGURATION EXAMPLES

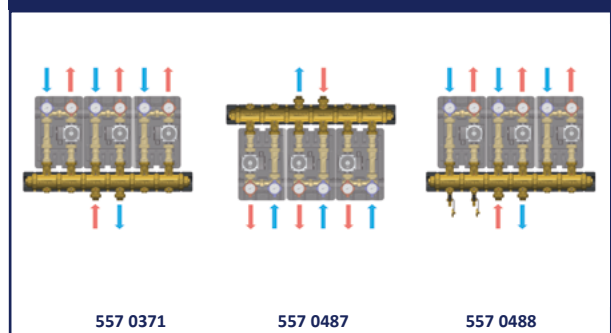

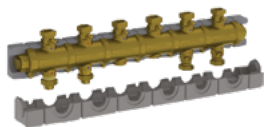

5538G4M6

Modular brass manifold for thermal plant complete with ball valves, insulation and fixing brackets. Centre distance 125 mm, flat seat connections and 1"1/2 idle nut

Code	Section	Circuits No.	Flow rate	Price €	Unit/Box
557 0477	2"1/2	4	2,2 (m³/h)		1/1
557 0478	2" 1/2	4	2,2 (m³/h)		1/1
557 0479	2" 1/2	4	2,2 (m³/h)		1/1

5538G4M6

CONFIGURATION EXAMPLES

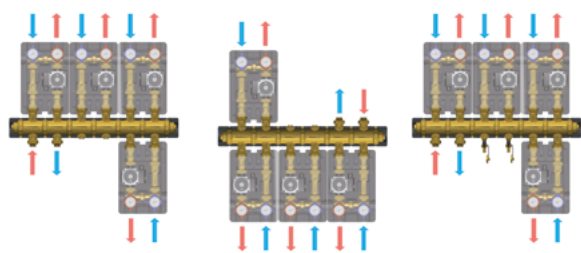

557 0477

557 0478

557 0479

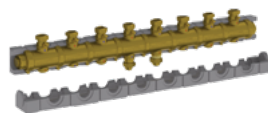

5538G4M8

Modular brass manifold for thermal plant complete with ball valves, insulation and fixing brackets. Centre distance 125 mm, flat seat connections and 1"1/2 idle nut

Code	Section	Circuits No.	Flow rate	Price €	Unit/Box
557 0480	2"1/2	4	2,2 (m³/h)		1/1
557 0481	2" 1/2	4	2,2 (m³/h)		1/1
557 0482	2" 1/2	4	2,2 (m³/h)		1/1

5538G4M8

CONFIGURATION EXAMPLES

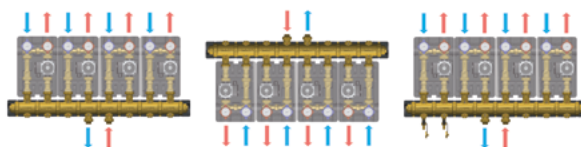

557 0480

557 0481

557 0482

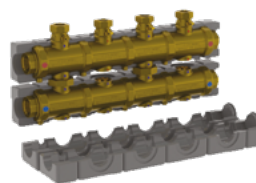

5540G2M4

Modular brass manifold for thermal plant complete with ball valves, insulation and fixing brackets. Centre distance 125 mm, flat seat connections and 1"1/2 idle nut

Code	Section	Circuits No.	Flow rate	Price €	Unit/Box
557 0372	2"1/2	2	6,5 (m³/h)		1/1
557 0489	2"1/2	2	6,5 (m³/h)		1/1
557 0490	2"1/2	2	6,5 (m³/h)		1/1

5540G2M4

CONFIGURATION EXAMPLES

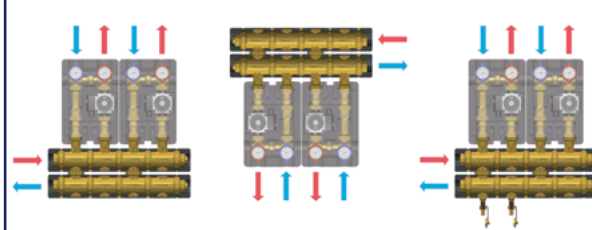

557 0372

557 0489

557 0490

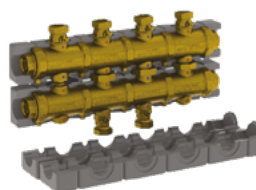

5540G3M4

Modular brass manifold for thermal plant complete with ball valves, insulation and fixing brackets. Centre distance 125 mm, flat seat connections and 1"1/2 idle nut

Code	Section	Circuits No.	Flow rate	Price €	Unit/Box
557 0373	2"1/2	3	6,5 (m³/h)		1/1
557 0491	2"1/2	3	6,5 (m³/h)		1/1
557 0492	2"1/2	3	6,5 (m³/h)		1/1

5540G3M4

CONFIGURATION EXAMPLES

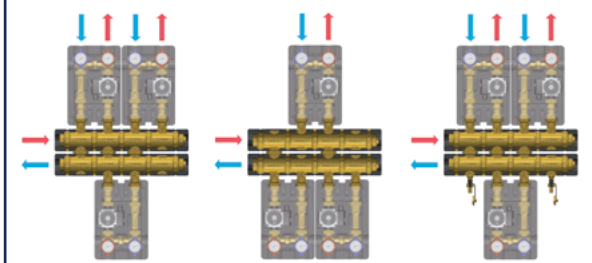

557 0373

557 0491

557 0492

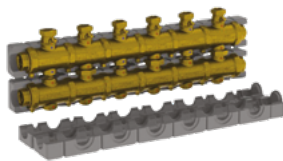

5540G3M6

Modular brass manifold for thermal plant complete with ball valves, insulation and fixing brackets. Centre distance 125 mm, flat seat connections and 1"1/2 idle nut

Code	Section	Circuits No.	Flow rate	Price €	Unit/Box
557 0374	2"1/2	3	6,5 (m³/h)		1/1
557 0493	2"1/2	3	6,5 (m³/h)		1/1
557 0494	2"1/2	3	6,5 (m³/h)		1/1

5540G3M6

CONFIGURATION EXAMPLES

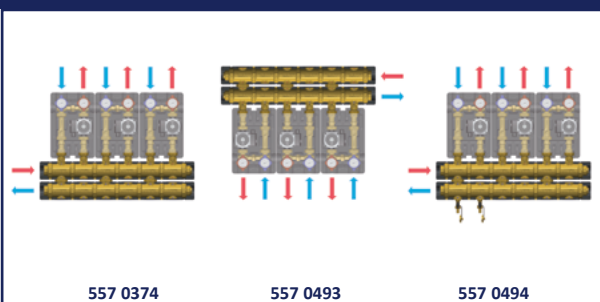

557 0374

557 0493

557 0494

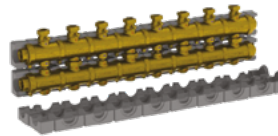

5540G4M8

Modular brass manifold for thermal plant complete with ball valves, insulation and fixing brackets. Centre distance 125 mm, flat seat connections and 1"1/2 idle nut

Code	Section	Circuits No.	Flow rate	Price €	Unit/Box
557 0376	2"1/2	4	6,5 (m³/h)		1/1
557 0497	2"1/2	4	6,5 (m³/h)		1/1
557 0498	2"1/2	4	6,5 (m³/h)		1/1

5540G4M8

CONFIGURATION EXAMPLES

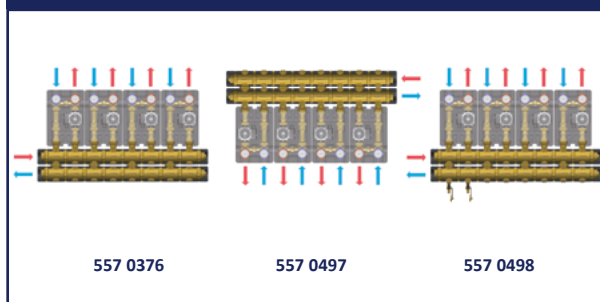

557 0376

557 0497

557 0498

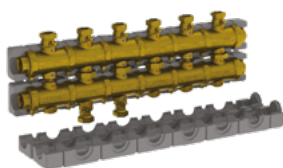

5540G4M6

Modular brass manifold for thermal plant complete with ball valves, insulation and fixing brackets. Centre distance 125 mm, flat seat connections and 1"1/2 idle nut

Code	Section	Circuits No.	Flow rate	Price €	Unit/Box
557 0375	2"1/2	4	6,5 (m³/h)		1/1
557 0495	2"1/2	4	6,5 (m³/h)		1/1
557 0496	2"1/2	4	6,5 (m³/h)		1/1

5540G4M6

CONFIGURATION EXAMPLES

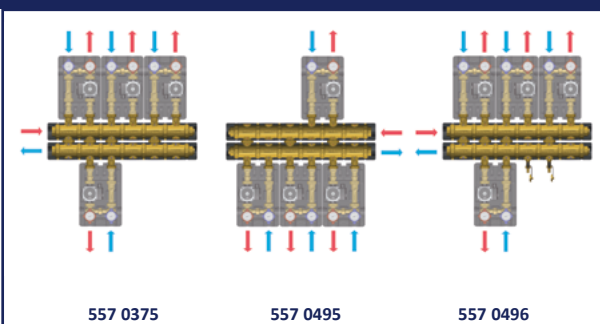

557 0375

557 0495

557 0496

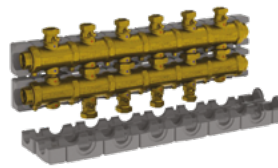

5540G5M6

Modular brass manifold for thermal plant complete with ball valves, insulation and fixing brackets. Centre distance 125 mm, flat seat connections and 1"1/2 idle nut

Code	Section	Circuits No.	Flow rate	Price €	Unit/Box
557 0377	2"1/2	5	6,5 (m³/h)		1/1
557 0499	2"1/2	5	6,5 (m³/h)		1/1
557 0500	2"1/2	5	6,5 (m³/h)		1/1

5540G5M6

CONFIGURATION EXAMPLES

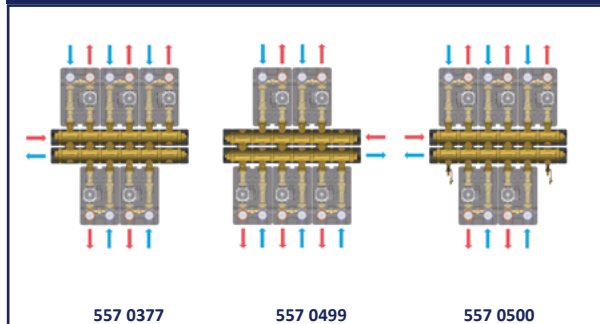

557 0377

557 0499

557 0500



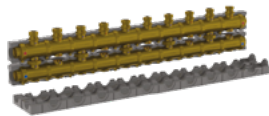

5540G5M10

Modular brass manifold for thermal plant complete with ball valves, insulation and fixing brackets. Centre distance 125 mm, flat seat connections and 1"1/2 idle nut

Code	Section	Circuits No.	Flow rate	Price €	Unit/Box
557 0476	2"1/2	5	6,5 (m³/h)		1/1
557 0501	2"1/2	5	6,5 (m³/h)		1/1
557 0502	2"1/2	5	6,5 (m³/h)		1/1

5540G5M10

CONFIGURATION EXAMPLES

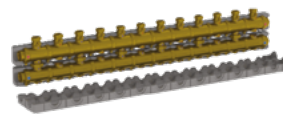
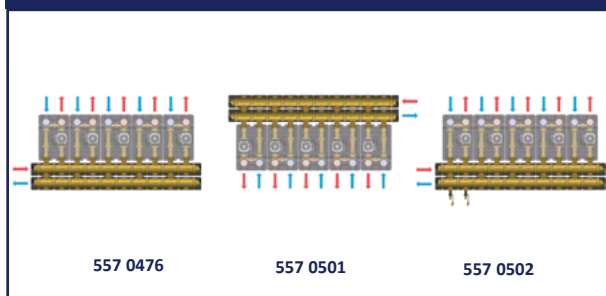

5540G6M12

Modular brass manifold for thermal plant complete with ball valves, insulation and fixing brackets. Centre distance 125 mm, flat seat connections and 1"1/2 idle nut

Code	Section	Circuits No.	Flow rate	Price €	Unit/Box
557 0505	2"1/2	6	6,5 (m³/h)		1/1
557 0506	2"1/2	6	6,5 (m³/h)		1/1
557 0507	2"1/2	6	6,5 (m³/h)		1/1

5540G6M12

CONFIGURATION EXAMPLES

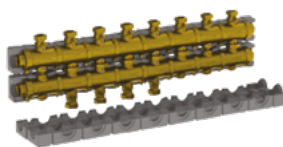
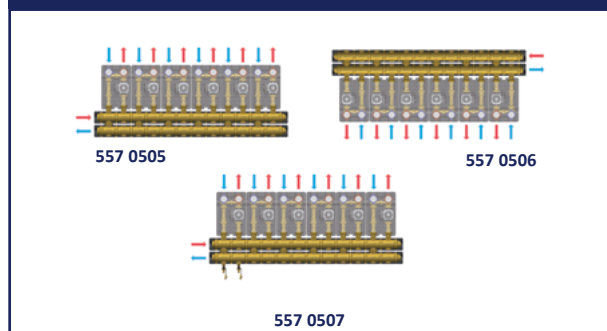

5540G6M8

Modular brass manifold for thermal plant complete with ball valves, insulation and fixing brackets. Centre distance 125 mm, flat seat connections and 1"1/2 idle nut

Code	Section	Circuits No.	Flow rate	Price €	Unit/Box
557 0378	2"1/2	6	6,5 (m³/h)		1/1
557 0503	2"1/2	6	6,5 (m³/h)		1/1
557 0504	2"1/2	6	6,5 (m³/h)		1/1

5540G6M8

CONFIGURATION EXAMPLES

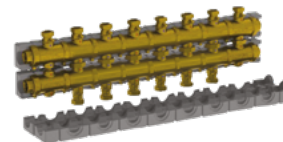
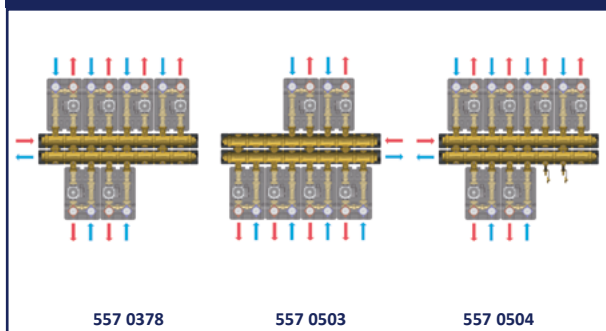

5540G7M8

Modular brass manifold for thermal plant complete with ball valves, insulation and fixing brackets. Centre distance 125 mm, flat seat connections and 1"1/2 idle nut

Code	Section	Circuits No.	Flow rate	Price €	Unit/Box
557 0508	2"1/2	7	6,5 (m³/h)		1/1
557 0509	2"1/2	7	6,5 (m³/h)		1/1
557 0510	2"1/2	7	6,5 (m³/h)		1/1

5540G7M8

CONFIGURATION EXAMPLES

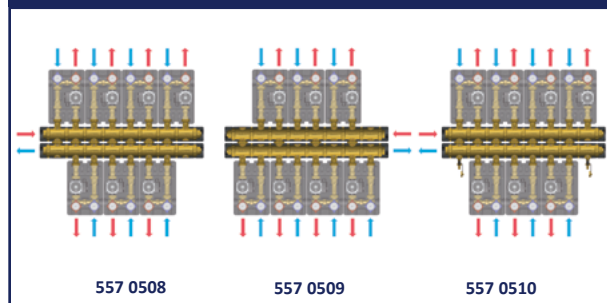

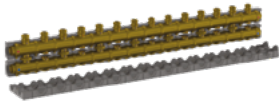

5540G7M14

Modular brass manifold for thermal plant complete with ball valves, insulation and fixing brackets. Centre distance 125 mm, flat seat connections and 1"1/2 idle nut

Code	Section	Circuits No.	Flow rate	Price €	Unit/Box
557 0472	2"1/2	7	6,5 (m³/h)		1/1
557 0511	2"1/2	7	6,5 (m³/h)		1/1
557 0512	2"1/2	7	6,5 (m³/h)		1/1

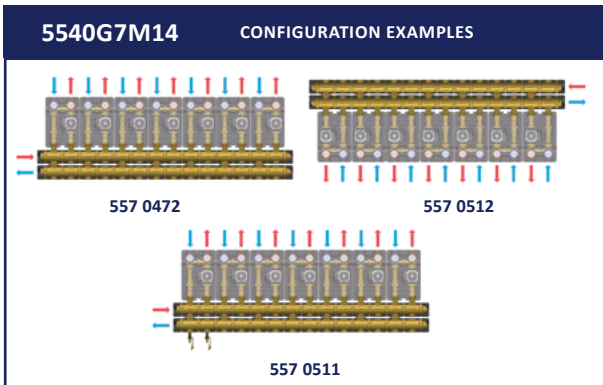

IMPORTANT

It is possible to create specific configurations based on CUSTOMER NEEDS



5538G - 5540G GUIDE TO CONNECTIONS

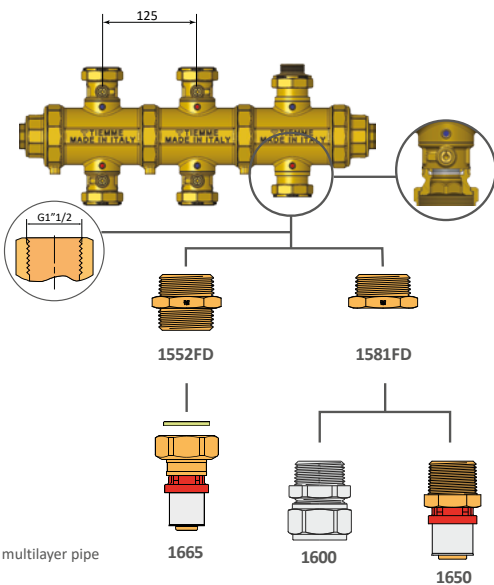
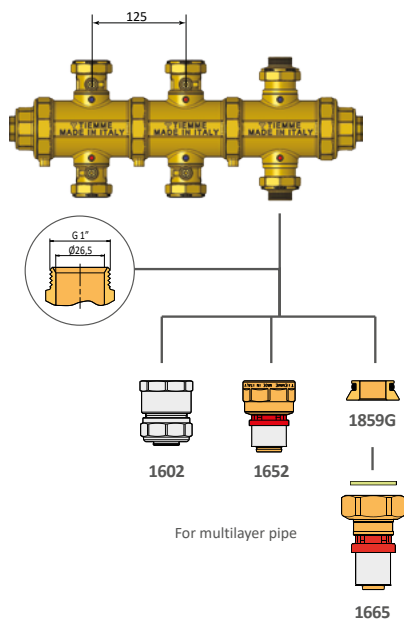

5540G GUIDE TO CONNECTIONS

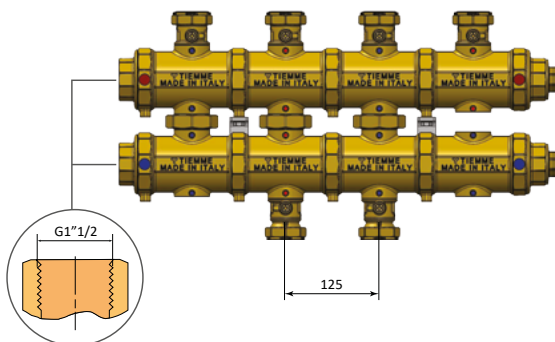

5538G - 5540G INSTALLATION

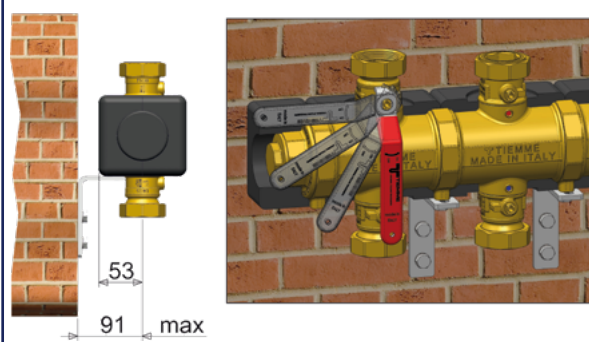

The wall installation is quick and easy thanks to the adjustable bracket to be fixed to the wall and to the manifold by screws. The seats for the screws were made directly on the manifold. With the ball valve directly installed on the manifold, it is possible to carry out maintenance operations by interrupting only the line concerned without stopping the remaining system that will remain in operation.

5538G DIMENSIONS

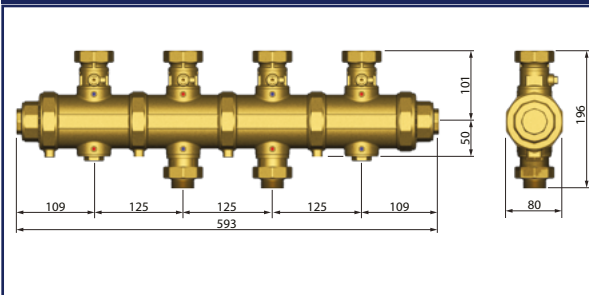

5540G DIMENSIONS

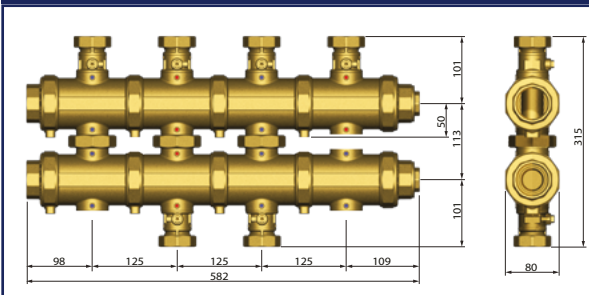



1602
Straight female fitting for multilayer pipe

Code	Type	Price €	Unit/Box
160 0112	25 x 2,5 - 1"		5/50
160 0029	26 x 3,0 - 1"		5/100
160 0039	32 x 3,0 - 1"		5/50



1652
Straight female fitting for multilayer pipe

Code	Type	Price €	Unit/Box
165 0268	25 x 2,5 - 1"		5/25
165 0053	26 x 3,0 - 1"		5/25
165 0050	32 x 3,0 - 1"		5/25



1665
Straight fitting with loose nut and flat gasket for multilayer pipe

Code	Type	Price €	Unit/Box
165 0233	25 x 2,5 - 1"		2/50
165 0071	26 x 3,0 - 1"		2/50
165 0134	32 x 3,0 - 1"		2/100
165 0239	40 x 3,5 - 1"1/2		1/25

Install with 1859

Install with 1552FD



1859
Adapter to transform 1" G connection into flat stop

Code	Type	Price €	Unit/Box
144 0234	1" G		10/300



1552FD
Male thread nipple with flat seat

Code	Type	Price €	Unit/Box
471 0086	1"1/2 x 1"1/2		2/30



1881
M/F reduction with O-ring for manifolds

Code	Type	Price €	Unit/Box
195 0066	1" 1/2 x 3/4"		5/70



1828Z
Bracket plus screws for manifolds from heating system

Code	Type	Price €	Unit/Box
179 0323	unica		1/25



2095R
Flat red plastic coated lever

Code	Type	Price €	Unit/Box
209 0069	unica		1/10



2121CP
ISO 228 male/female ball valve with aluminium lever for manifolds and FLAT GASKET

Code	Type	Price €	Unit/Box
 red lever			
212 0122	1"1/2		3/12
 black lever			
212 0124	1"1/2		3/12



The pumping station DN25 art. 5535G performs the function of powering the high temperature circuits of the heating systems, directly from the out points of a manifold, without changing the temperature of the inlet fluid. Through the two thermometers it is possible to control the instantaneous temperature of supply and return. On the return branch is inserted a check valve that avoids the self-circulation of the fluid when the circulator is switched off. To underline the possibility of equipping the group with optional components such as differential by-pass (art. 5535DIFF) and/or safety countertop thermostat (art. 2075KIT03).



1. Delivery ball valve with thermometer
2. Circulation pump (if any)
3. Delivery
4. Return
5. Insulation in EPP
6. Fixing brackets
7. Check valve
8. Return branch
9. Return ball valve with thermometer

PRODUCT RANGE



5535G
Pumping station



TECHNICAL CHARACTERISTICS

- Body material: Brass CW 617 N
- Gaskets material: EPDM
- Insulating shell material: EPP
- Dimension: DN25 (1")
- Connections centre distance 125 mm:
 - Inlet: 1"1/2 male flat stop
 - Outlet: 1"1/2 male flat stop
- Working max P: 8 bar
- Working max T: 110°C

Code	Type	Price €	Unit/Box
316 0017	Without circulating pump		1/1
316 0043	Wilo PARA 25/7		1/1
316 0042	UPM3 HYBRID 25/70		1/1
316 0090	Wilo PARA 25/9		1/1
316 0018	Grundfos UPS 25-65		1/1

ErP READY

Available for non-EU countries

CIRCULATORY HYDRAULIC HEAD PRESSURE DROP DIAGRAM

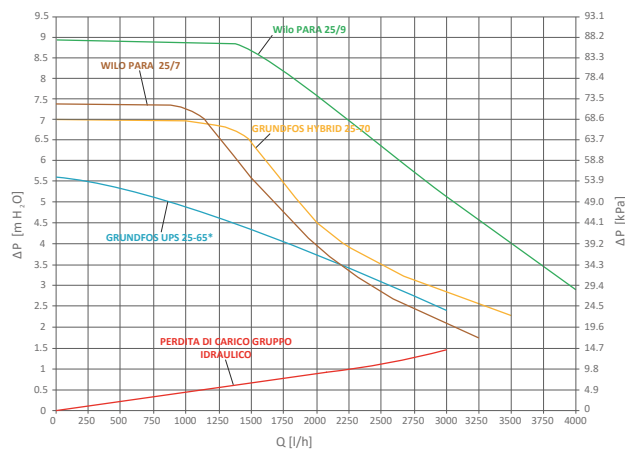

The mixing unit DN25 art. 5535GPF performs the function of powering the low temperature circuits of radiant heating systems, directly from the out points of a manifold, changing the inlet fluid temperature to the project value (function guaranteed by the mixing valve controlled by a thermostatic head). Through the two thermometers it is possible to control the instantaneous temperature of supply and return. On the return branch is inserted a check valve that avoids the self-circulation of the fluid when the circulator is switched off. The mixing unit is also supplied complete with a Safety thermostat in contact (intervention temperature 55 °C) to safeguard the plant. The group can be equipped with optional components such as differential bypass (art. 5535DIFF).



1. Safety thermostat
2. Delivery ball valve with thermometer
3. Probe well with nipple
4. Circulation pump (if any)
5. 3-way mixing valve with thermostatic head
6. Delivery
7. Return
8. Insulation in EPP
9. Fixing brackets
10. Check valve
11. Return branch
12. Return ball valve with thermometer

PRODUCT RANGE



5535GPF

Fixed point mixing unit



TECHNICAL CHARACTERISTICS

- Body material: Brass CW 617 N
- Gaskets material: EPDM
- Insulating shell material: EPP
- Dimension: DN25 (1")
- Connections centre distance 125 mm:
 - Inlet: 1"1/2 male flat stop
 - Outlet: 1"1/2 male flat stop
- Working max P: 8 bar
- Working max T: 110°C
- Temperature regulation: 20÷50°C
- Safety thermostat: 55°C

Code	Type	Price €	Unit/Box
316 0020	Without circulating pump		1/1
316 0046	Wilo PARA 25/7		1/1
316 0045	Grundfos UPM3 HYBRID 25/70		1/1
316 0091	Wilo PARA 25/9		1/1
316 0021	Grundfos UPS 25-65		1/1

ErP READY

Available for non-EU countries

CIRCULATORY HYDRAULIC HEAD PRESSURE DROP DIAGRAM

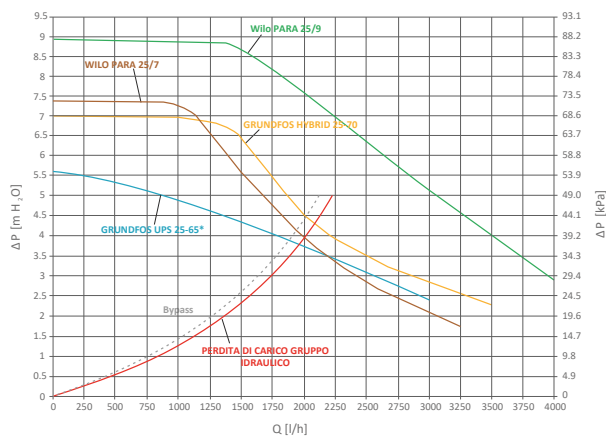

The mixing unit DN25 art. 5535G3P performs the function of feeding the circuits of the heating systems, directly from the out points of a manifold, modifying the temperature of the fluid in input to the project value (function guaranteed by the mixing valve controlled by a 3-point servo motor). Through the two thermometers it is possible to control the instantaneous temperature of supply and return. On the return branch is inserted a check valve that prevents self-circulation of the fluid when the circulator is switched off. To underline the possibility of equipping the group with optional components such as differential by-pass (art. 5535DIFF) and/or safety thermostat (art. 2075KIT03).



1. Delivery ball valve with thermometer
2. Well for \varnothing 6 mm probe with nipple
3. Circulation pump (if any)
4. 3-way mixing valve with servo motor
5. Delivery
6. Return
7. Insulation in EPP
8. Fixing brackets
9. Check valve
10. Return branch
11. Return ball valve with thermometer

PRODUCT RANGE



5535G3P

Mixing unit with servo motor



TECHNICAL CHARACTERISTICS

- Body material: Brass CW 617 N
- Gaskets material: EPDM
- Insulating shell material: EPP
- Dimension: DN25 (1")
- Connections centre distance 125 mm:
 - Inlet: 1"1/2 male flat stop
 - Outlet: 1"1/2 male flat stop
- Working max P: 8 bar
- Working max T: 110°C

SERVOMOTOR

- Power supply: 230 Vac SPDT control (3 points)
- Rotation Time: 120 sec (90° angle)
- Nominal torque: 7 Nm

Code	Type	Price €	Unit/Box
316 0023	Without circulating pump		1/1
316 0049	Wilo PARA 25/7		1/1
316 0048	Grundfos UPM3 HYBRID 25/70		1/1
316 0092	Wilo PARA 25/9		1/1
316 0024	Grundfos UPS 25-65		1/1

ErP READY

Available for non-EU countries

CIRCULATORY HYDRAULIC HEAD PRESSURE DROP DIAGRAM

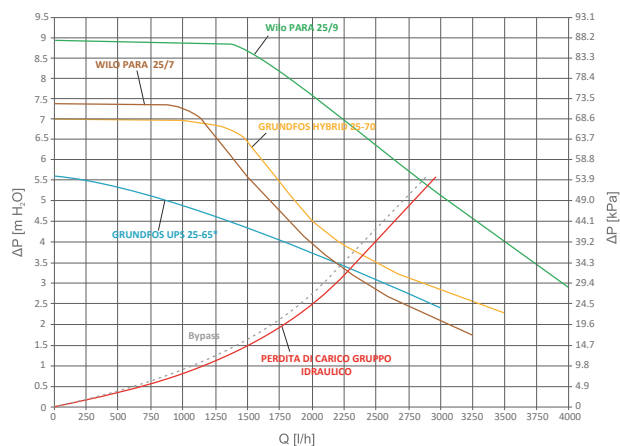

The pumping station DN25 art. 5536G is the variant of the pumping station 5535G dedicated to the construction of cooling systems. To achieve this, the pumping station has been equipped with EPP insulation, which reduces the risk of condensation on metal surfaces. The pumping station performs the function of feeding the circuits of the heating/cooling systems, directly from the out points of a manifold, without changing the inlet fluid temperature. Through the two thermometers it is possible to control the instantaneous temperature of supply and return. On the return branch is inserted a check valve that avoids the self-circulation of the fluid when the circulator is switched off. To underline the possibility of equipping the group with optional components such as differential by-pass (art. 5535DIFF) and/or safety thermostat (art. 2075KIT03).



1. Delivery ball valve with thermometer
2. Circulation pump (if any)
3. Delivery
4. Return
5. Insulation in Pex foam
6. Fixing brackets
7. Check valve
8. Return branch
9. Return ball valve with thermometer

PRODUCT RANGE



5536G

Pumping station with insulation for cooling



TECHNICAL CHARACTERISTICS

- Body material: Brass CW 617 N
- Gaskets material: EPDM
- Insulating shell material: PE-X closed cell foam
- Dimension: DN25 (1")
- Connections centre distance 125 mm:
 - Inlet: 1"1/2 male flat stop
 - Outlet: 1"1/2 male flat stop
- Working max P: 8 bar
- Working max T: 110°C

Code	Type	Price €	Unit/Box
557 0383	Without circulating pump		1/1
557 0386	Wilo PARA 25/7		1/1
557 0559	Wilo PARA 25/9		1/1

ErP READY

CIRCULATORY HYDRAULIC HEAD PRESSURE DROP DIAGRAM

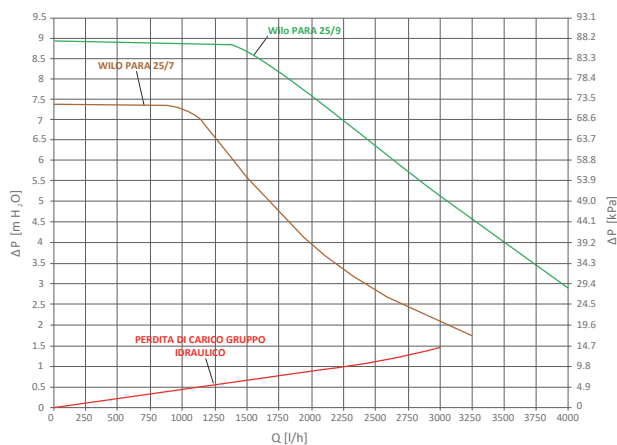

The mixing unit DN25 art. 5536GS is the variant of the unit 5535G3P dedicated to the construction of cooling systems. To achieve this, the pumping station has been equipped with EPP insulation, which reduces the risk of condensation on metal surfaces. The group performs the function of feeding the circuits of the heating/cooling systems, directly from the out points of a manifold, modifying the temperature of the fluid in input to the project value (function guaranteed by the mixing valve controlled by a servo motor). Through the two thermometers it is possible to control the instantaneous temperature of supply and return. On the return branch is inserted a check valve that avoids the self-circulation of the fluid when the circulator is switched off. To underline the possibility of equipping the group with optional components such as differential by-pass (art. 5535DIFF) and/or safety thermostat (art. 2075KIT03).



1. Delivery ball valve with thermometer
2. Well for \varnothing 6 mm probe with nipple
3. Circulation pump (if any)
4. 3-way mixing valve with servo motor
5. Delivery
6. Return
7. Insulation in PEX foam
8. Fixing brackets
9. Check valve
10. Return branch
11. Return ball valve with thermometer

PRODUCT RANGE



5536GS

Mixing unit with servo motor and cooling insulation



TECHNICAL CHARACTERISTICS

- Body material: Brass CW 617 N
- Gaskets material: EPDM
- Insulating shell material: PE-X closed cell foam
- Dimension: DN25 (1")
- Connections centre distance 125 mm:
 - Inlet: 1"1/2 male flat stop
 - Outlet: 1"1/2 male flat stop
- Working max P: 8 bar
- Working max T: 110°C

SERVOMOTOR

- Power supply: 24 Vac (0-10vdc control)
- Rotation Time: 120 sec (90° angle)
- Nominal torque: 7 Nm

Code	Type	Price €	Unit/Box
557 0388	Without circulating pump		1/1
557 0391	Wilo PARA 25/7		1/1
557 0560	Wilo PARA 25/9		1/1

ErP READY

CIRCULATORY HYDRAULIC HEAD PRESSURE DROP DIAGRAM

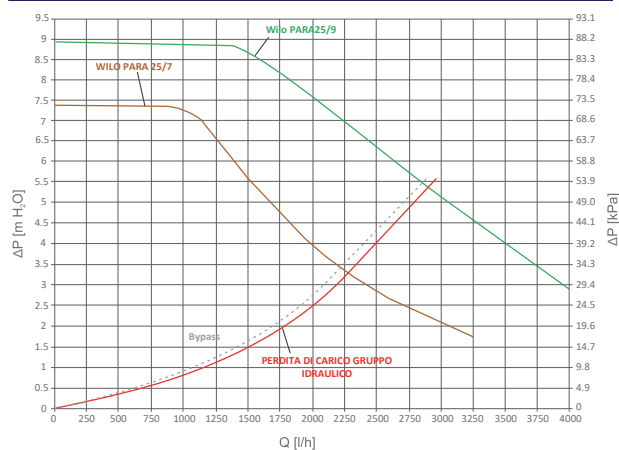

The pumping station DN32 art. 5534G performs the function of feeding the circuits of the heating/ cooling systems, directly from the out points of a manifold, without changing the temperature of the inlet fluid. Through the two thermometers it is possible to control the instantaneous temperature of supply and return. On the return branch is inserted a check valve that avoids the self-circulation of the fluid when the circulator is switched off.

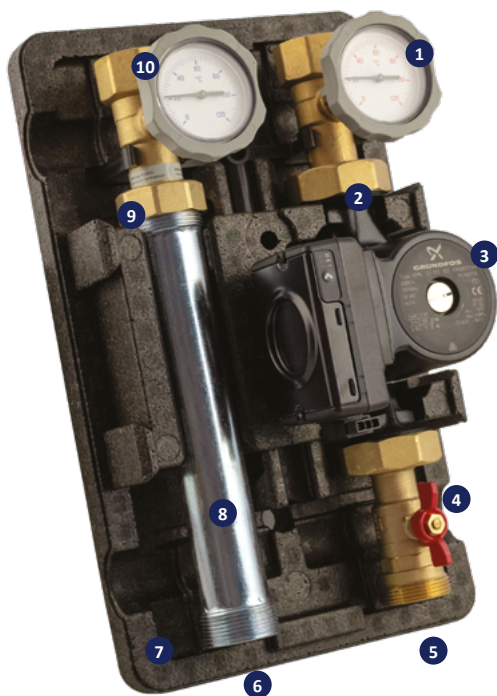

1. Delivery ball valve with thermometer
2. Check valve
3. Circulation pump (if any)
4. Pump connection valve
5. Delivery
6. Return
7. Insulation
8. Return branch
9. Check valve
10. Return ball valve with thermometer

PRODUCT RANGE

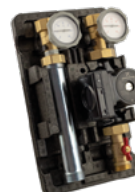

5534G

Pumping station



TECHNICAL CHARACTERISTICS

- Body material: Brass CW 617 N
- Gaskets material: EPDM
- Insulating shell material: EPP
- Dimension: DN32 (1"1/4)
- Connections centre distance 125 mm:
 - Inlet: 1"1/2 male flat stop
 - Outlet: 1"1/4 femmina
- Working max P: 8 bar
- Working max T: 110°C

Code	Type	Price €	Unit/Box
316 0093	Without circulating pump		1/1
316 0095	Grundfos UPML 32-105 AUTO		1/1

ErP READY

CIRCULATORY HYDRAULIC HEAD PRESSURE DROP DIAGRAM

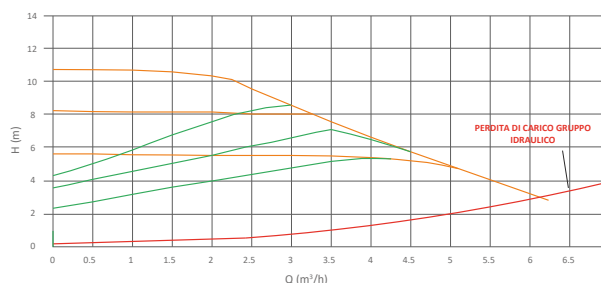

- Operation at constant flow
- Operation at variable flow
- Pumping station pressure drop



PRICE LIST

The mixing unit DN32 art. 5534G3P performs the function of feeding the circuits of the heating/cooling systems, directly from the out points of a manifold, changing the temperature of the incoming fluid to the project value (function guaranteed by the mixing valve controlled by a servo motor - accessory art. 9562SERV to be purchased separately). Through the two thermometers it is possible to control the instantaneous temperature of supply and return. On the return branch is inserted a check valve that avoids the self-circulation of the fluid when the circulator is switched off.

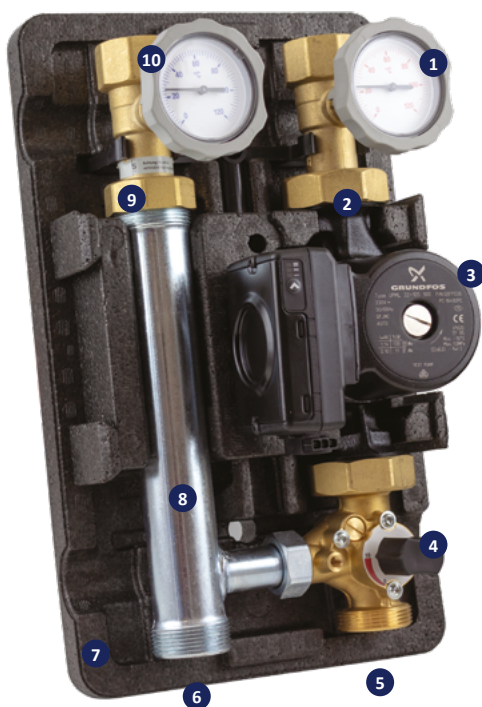

1. Delivery ball valve with thermometer
2. Check valve
3. Circulation pump (if any)
4. Mixing valve (optional servo motor)
5. Delivery
6. Return
7. Insulation
8. Return branch
9. Check valve
10. Return ball valve with thermometer

PRODUCT RANGE



5534G3P

Mixing unit for servo motor (not included)



TECHNICAL CHARACTERISTICS

- Body material: Brass CW 617 N
- Gaskets material: EPDM
- Insulating shell material: EPP
- Dimension: DN 32
- Connections centre distance 125 mm:
 - Inlet: 1"1/2 male flat stop
 - Outlet: 1"1/4 femmina
- Working max P: 8 bar
- Working max T: 110°C

i To be combined with the 9562SERV servo motor

Code	Type	Price €	Unit/Box
316 0097	Without circulating pump		1/1
316 0099	Grundfos UPML 32-105 AUTO		1/1

ErP READY

CIRCULATORY HYDRAULIC HEAD PRESSURE DROP DIAGRAM

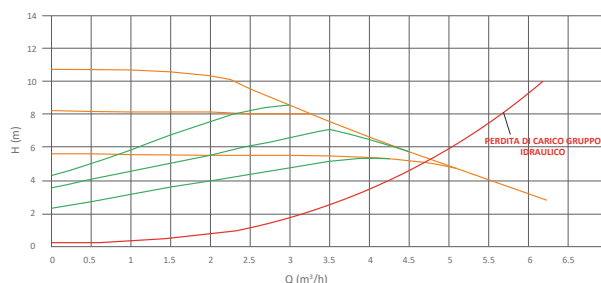

- Operation at constant flow
- Operation at variable flow
- Pumping station pressure drop



5535DIFF
Differential By-pass with 50-400 mbar adjustment. Connection M25x1,5. (Can be used on all hydraulic power units)

Code	Type	Price €	Unit/Box
316 0029	50-400 mbar		1/50



2075KIT03
Safety countertoped thermostat, including cable with straight connector

Code	Type	Price €	Unit/Box
557 0024	55 °C		1/1



3880GPF
Mixing valve for fixed point adjustment

i To be combined with the thermostatic kit 9561KIT02

Code	Type	Price €	Unit/Box
316 0030	-		1/4



9561KIT02
Nipple + well + 20-50 °C thermostatic head kit with remote probe. Attack M30x1.5

i For use with fixed point mixing unit 5535GPF

Code	Type	Price €	Unit/Box
450 0150	20-50 °C		1/10

NEW



3670PSA
"Y" fitting for temperature probe (dry mounting)



Code	Type	Price €	Unit/Box
651 0356	1" 1/4		4/16
651 0887	1" 1/2		3/12



3880GSM
Sector mixing valve for servo motor control (not supplied)

i To be combined with servo motor 9562SERV

Code	Type	Price €	Unit/Box
316 0031	-		1/4



9562SERV
Servo motor complete with kit for connection to the mixing valve 3880GSM

TECHNICAL CHARACTERISTICS

- Body material: PA FV Self-extinguishing
- Rotation Time: 120 sec.
- Angle of rotation: 90°
- Nominal torque: 7 Nm
- Degree of protection: IP 40
- Power supply:
 - 230 Vac SPDT (3 points)
 - 24 Vac SPDT (3 points)
 - 24 Vac (0 - 10 Vdc)

Code	Type	Price €	Unit/Box
557 0023	230 Vac SPDT (3 points)		1/8
557 0306	24 Vac SPDT (3 points)		1/8
557 0307	24 Vac 0-10 Vdc		1/8



4745MANOP
Knob with immersion thermometer for hydraulic power units

Code	Type	Price €	Unit/Box
470 0183	Blu		10/40
470 0184	Rossa		10/40



5537KIT
Nipple + well kit for Ø 6 mm probe. M25x1.5 connection

i For use with mixing unit with servo motor 5535G3P

Code	Type	Price €	Unit/Box
557 0022	-		1/25



PRICE LIST



1665
Straight fitting with loose nut and flat gasket for multilayer pipe

Code	Type	Price €	Unit/Box
165 0240	32 x 3,0 - 1"1/2		1/50
165 0239	40 x 3,5 - 1"1/2		1/25



1557SET
Brass pump female fitting kit with flat seat

i Kit includes: 2 tangs, 2 rotating nuts, 2 gaskets

Code	Type	Dado folle	Price €	Unit/Box
150 0355	1"	1"1/2		1/20



3890PW2
Wilo PARA high efficiency circulation pump 25/7 130 mm centre distance

+ HIGH EFFICIENCY PUMP

Code	Type	Price €	Unit/Box
450 0358	Wilo PARA 25/7		1/1



3890PW5
Wilo PARA 25/9 high efficiency circulation pump 130 mm centre distance. 1"1/2 connection on cast iron body

+ HIGH EFFICIENCY PUMP

Code	Type	Price €	Unit/Box
450 0557	Wilo PARA 25/9		1/1



3890PV
Grundfos UPM3 HYBRID 25/70 high efficiency circulation pump 130 mm centre distance. 1"1/2 connection on cast iron body

+ HIGH EFFICIENCY PUMP

Code	Type	Price €	Unit/Box
450 0091	Grundfos UPM3 HYBRID 25/70		1/1



3890P
Grundfos UPS 25-55 3 speeds circulation pump 130 mm centre distance. 1"1/2 connection on cast iron body

Code	Type	Price €	Unit/Box
450 0033	Grundfos UPS 25-55		1/1

Available for non-EU countries



3890PU
High efficiency circulation pump. Connections from 2" 180 mm centre distance

+ HIGH EFFICIENCY PUMP

Code	Type	Price €	Unit/Box
450 0637	Grundfos UPML 32-105		1/1

SINGLE FAMILY SYSTEM

Single family heating and cooling radiant system with boiler and heat pump. Tiemme manifold in brass art. 5538G2M4 with Tiemme hydraulic separator art. 7166.

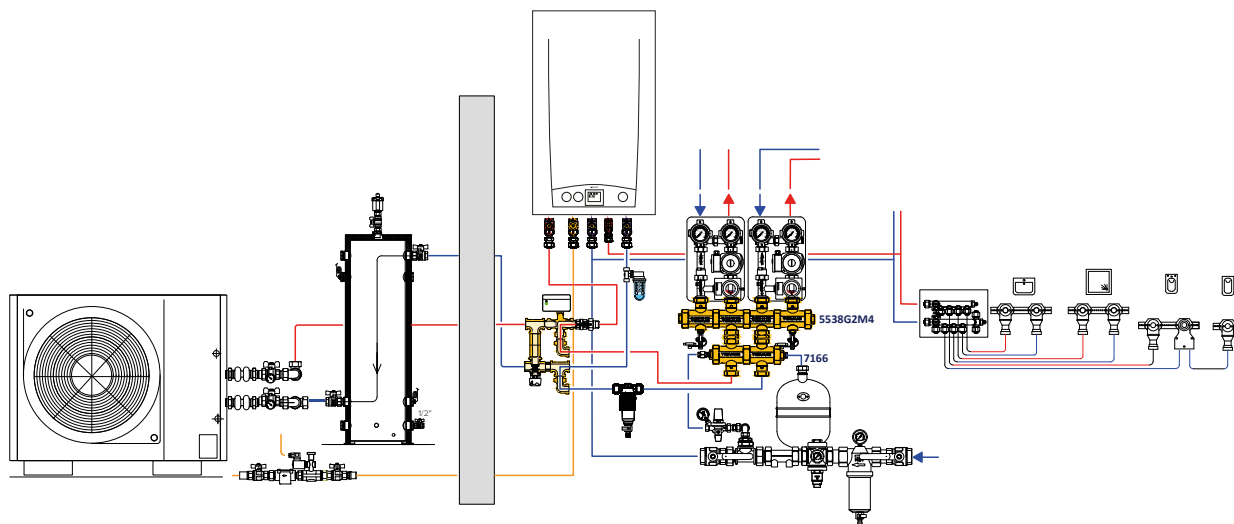

MULTI-FAMILY SYSTEM

Multi-family system with thermal generators in cascade. Tiemme brass manifold art. 5540G6M12 and Tiemme hydraulics separator art. 3144 complete with drain tap and actuator.

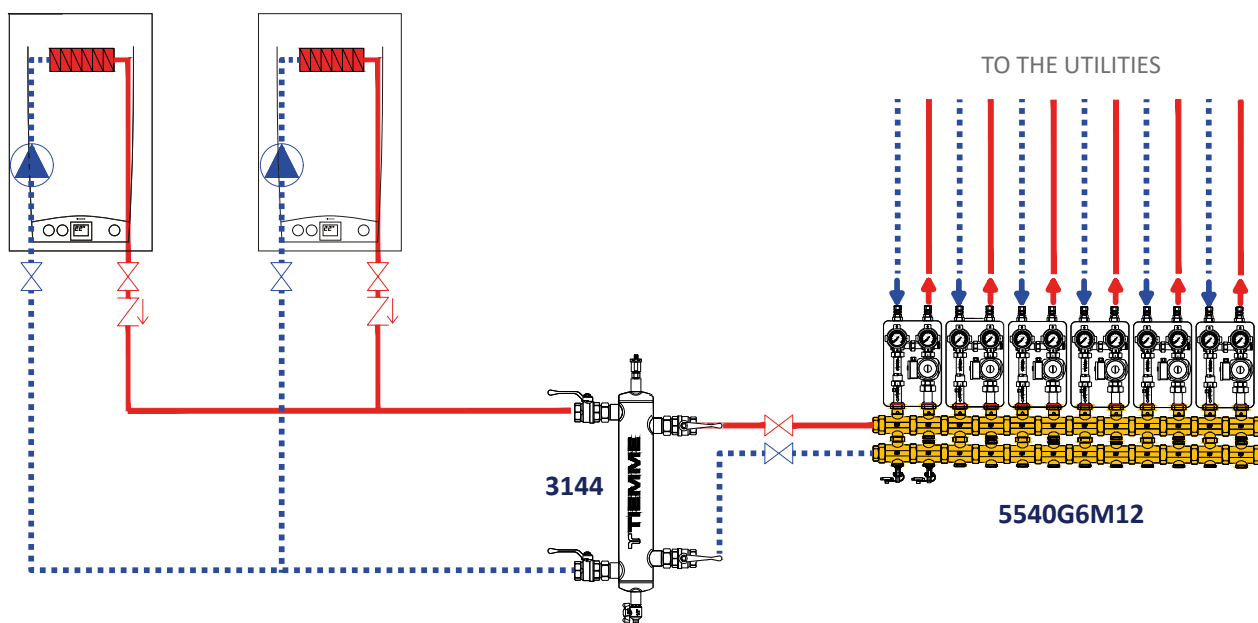

Tiemme multi-zone distribution modules are able to ensure the right flow of carrier fluid and adequate hydraulic head in all heating/cooling systems that need an additional performance compared to the boiler circulator.

The compact dimensions allow the module to be installed close to the 24 kW wall boilers.

With the mixed zone (fixed or motorized point) it is also possible to manage and modify the delivery temperature of the heating zones with respect to the generator delivery temperature.

The hydraulic separator integrated in the module ensures the hydraulic disconnection of the generator from the heating zones, making them hydraulically independent.

EXAMPLES OF INSTALLATION

Heating system with 3 zones:

- 1 direct zone managed in high temperature for the supply of radiators;
- 2 mixed zones managed at low temperature for the supply of radiant systems.

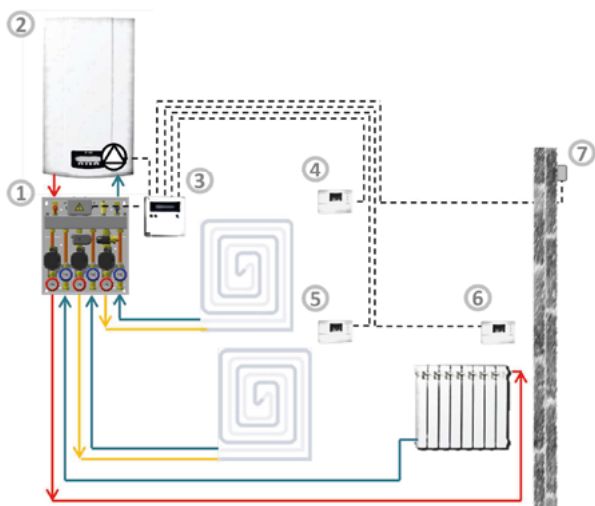

KEY:

1. Module Art. 5584 (with 1 direct circuit + 2 circuits with mixer and servo motor)
2. Gas generator with integrated circulator
3. Control group
4. Low temperature heating circuit
5. Low temperature heating circuit
6. High temperature heating circuit
7. External probe for thermoregulation

Heating system with 3 zones:

- 1 direct zone managed in high temperature for the supply of radiators;
- 1 direct zone managed in high temperature for the supply of sanitary storage tank;
- 1 mixed zone managed at low temperature for the supply of radiant systems.

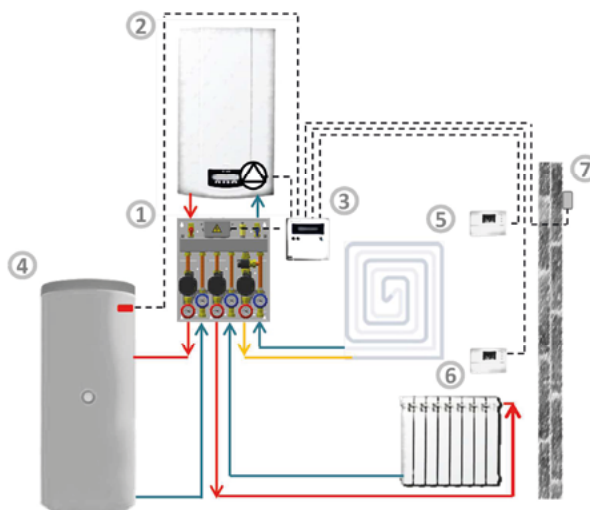

KEY:

1. Module Art. 5583 (with 2 direct circuits + 1 circuit with fixed point mixer)
2. Gas generator with integrated circulator
3. Control group
4. Integration circuit for sanitary storage tank
5. Low temperature heating circuit
6. High temperature heating circuit
7. External probe for thermoregulation

COMPONENT DESCRIPTION / DIMENSIONAL CHARACTERISTICS

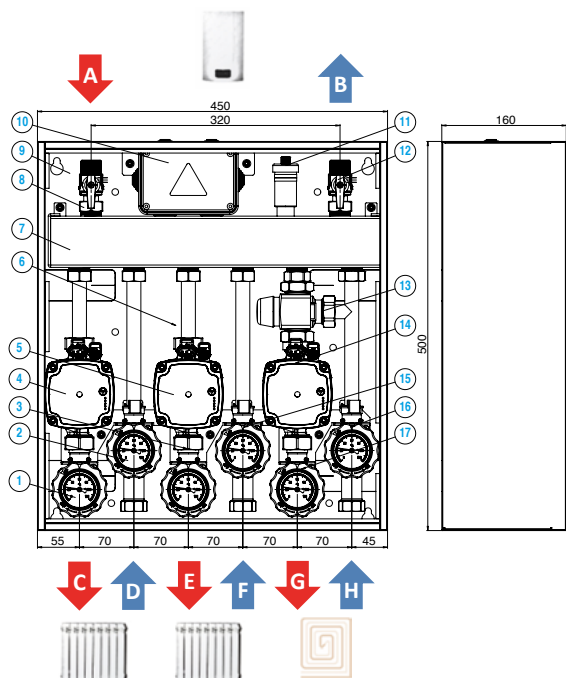

KEY:

- A.** Generator delivery
 - B.** Generator return
 - C.** Zone 1 delivery
 - D.** Zone 1 return
 - E.** Zone 2 delivery
 - F.** Zone 2 return
 - G.** Zone 3 delivery
 - H.** Zone 3 return
1. Zone 1 delivery tap
 2. Zone 1 return tap
 3. Zone 2 delivery tap
 4. Zone 1 circulator
 5. Zone 2 circulator
 6. -
 7. Hydraulic separator
 8. Generator delivery tap
 9. Metal box
 10. Electric support box
 11. Automatic air vent
 12. Generator return tap
 13. Zone 3 mixing valve
 14. Zone 3 circulating pump
 15. Zone 2 return tap
 16. Zone 3 delivery tap
 17. Zone 3 return tap

PRODUCT RANGE

NEW



5582ISOL

Box distribution module with direct circuits, insulated



TECHNICAL CHARACTERISTICS

- Dimension: DN 20
- Connections:
 - Generator: 3/4" M - centre distance 320 mm
 - Heating: 3/4" F - centre distance 70 mm
- Working max P: 10 bar
- Working max T: 95°C
- Circulating pump: Grundfos UPM3 Hybrid 15-70 Erp ready

Code	Type	Price €	Unit/Box
316 0133	2 Direct zones		1/1

NEW



5582

Distribution module in box with direct circuits



TECHNICAL CHARACTERISTICS

- Dimension: DN 20
- Connections:
 - Generator: 3/4" M - centre distance 320 mm
 - Heating: 3/4" F - centre distance 70 mm
- Working max P: 10 bar
- Working max T: 95°C
- Circulating pump: Grundfos UPM3 Hybrid 15-70 Erp ready

Code	Type	Price €	Unit/Box
316 0134	3 Direct zones		1/1

NEW



5583

Distribution module in box with fixed point mixers



TECHNICAL CHARACTERISTICS

- Dimension: DN 20
- Connections:
 - Generator: 3/4" M - centre distance 320 mm
 - Heating: 3/4" F - centre distance 70 mm
- Working max P: 10 bar
- Working max T: 95°C
- Circulating pump: Grundfos UPM3 Hybrid 15-70 Erp ready
- Temperature control range: 20÷55 °C

Code	Type	Price €	Unit/Box
316 0135	1 Direct Zone + 1 Fixed Point Mixed Zone		1/1
316 0136	2 Direct zones + 1 Fixed Point Mixed Zone		1/1
316 0137	1 Direct Zone + 2 Fixed point mixed zones		1/1
316 0149	2 Fixed point mixed zones		1/1



NEW



5584ISOL

Box distribution module with mixers and servo motors, insulated



TECHNICAL CHARACTERISTICS

- Dimension: DN 20
- Connections:
 - Generator: 3/4" M - centre distance 320 mm
 - Heating: 3/4" F - centre distance 70 mm
- Working max P: 10 bar
- Working max T: 95°C
- Circulating pump: Grundfos UPM3 Hybrid 15-70 Erp ready
- Motorized mixing valve: 230 Vac - 3 points

Code	Type	Price €	Unit/Box
316 0138	1 Direct Zone + n° 1 Zona miscelata motorizzata		1/1
316 0139	2 Direct zones + n° 1 Zona miscelata motorizzata		1/1

NEW



5584

Box distribution module with mixers and servomotors



TECHNICAL CHARACTERISTICS

- Dimension: DN 20
- Connections:
 - Generator: 3/4" M - centre distance 320 mm
 - Heating: 3/4" F - centre distance 70 mm
- Working max P: 10 bar
- Working max T: 95°C
- Circulating pump: Grundfos UPM3 Hybrid 15-70 Erp ready
- Motorized mixing valve: 230 Vac - 3 points

Code	Type	Price €	Unit/Box
316 0140	1 Direct Zone + 2 Motorized mixed zones		1/1

Tiemme biomass circulation and separation hydraulic power units allow to combine generators powered by different fuels, such as gas and biomass generators, on the same heating circuit.

Tiemme modules, in addition to the hydraulic management of the heating circuit, comply with the requirements of the ISPESL 18/09/2006 circular and provide hydraulic performance at the highest levels.

The presence of a heat exchanger interposed between the two generators constitutes a hydraulic break between the respective thermal energy carrier fluid and therefore it is considered not to proceed to the sum of the potential.

EXAMPLES OF INSTALLATION

Heating system with two generators, one of which is solid fuel with circulator and separator module system.

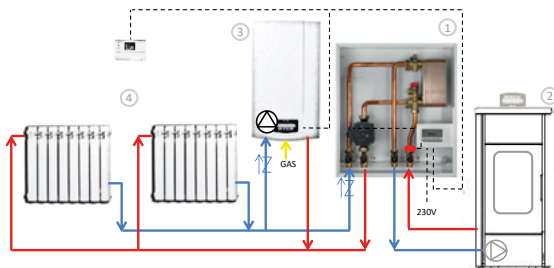

KEY:

1. Module Art. 5585 / 5585A
2. Biomass generator with integrated circulator
3. Gas generator for integration
4. Heating circuit

Heating system with two generators, of which one with solid fuel without circulator and separator module system.

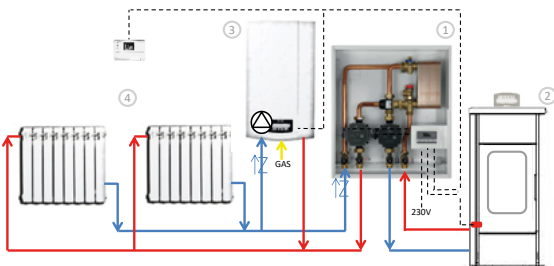

KEY:

1. Module Art. 5585C / 5585AC
2. Biomass generator without circulator
3. Gas generator for integration
4. Heating circuit

COMPONENT DESCRIPTION / DIMENSIONAL CHARACTERISTICS

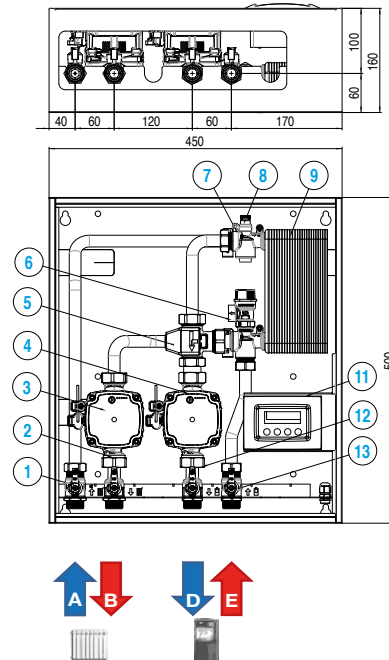

KEY:

- A. Return from heating
- B. Delivery from heating
- D. Return to the generator
- E. Delivery to the generator

1. Return heating/non return tap
2. Heating delivery tap
3. Heating circulator
4. Generator circulator (present in the modules art. 5585C and 5585AC)
5. Thermostatic anti-condensation valve (present in the modules art. 5585A and 5585AC)
6. Safety valve for heating
7. Heating air vent
8. Generator air vent
9. Plate exchanger
10. Generator delivery probe
11. Centralina di controllo
12. Generator return tap
13. Generator delivery tap



TIEMME INFORMS

THERMAL SYSTEMS WITH ADDITIONAL GENERATOR - CIRCULAR ISPESL OF 18/09/2006:

The ISPESL of 18/09/2006 circular, on structured thermal installations with two heat generators, one of which powered by solid fuel and the other with different fuel, precises: in the case where the primary thermal energy carrier fluid of two generators enters the thermal storage tank without any dividing elements, the sum of the potentials is considered and therefore, if the value of 35 kW is exceeded, the plant will not only fall under the obligation provided for by UNI 7129 but will have to refer to MD 08/11/19 with regard to fire prevention, taking into account the mentioned regulatory updates. The presence of a heat exchanger interposed between the two generators constitutes a hydraulic break between the respective thermal energy carrier fluids and therefore it is considered not to proceed to the sum of the potential.

PRODUCT RANGE

NEW



5585

Circulation and biomass plant management unit with plate heat exchanger

TECHNICAL CHARACTERISTICS

- Dimension: DN 20
- Connections:
 - Primary circuit: 3/4" M
 - Heating circuit: 3/4" M
 - Centre distance: 60 mm
- Working max P: 10 bar
- Working max T: 95°C
- Circulating pump: Grundfos UPM3 Hybrid 15-70 Erp ready

Code	Type	Price €	Unit/Box
316 0141	-		1/1

NEW



5585A

Circulation and biomass plant management unit with plate heat exchanger.
With anti-condensation valve

TECHNICAL CHARACTERISTICS

- Dimension: DN 20
- Connections:
 - Primary circuit: 3/4" M
 - Heating circuit: 3/4" M
 - Centre distance: 60 mm
- Working max P: 10 bar
- Working max T: 95°C
- Circulating pump: Grundfos UPM3 Hybrid 15-70 Erp ready
- Anti-condensation valve: 60 °C

Code	Type	Price €	Unit/Box
316 0142	-		1/1

NEW



5585C

Circulation and biomass plant management unit with plate heat exchanger.
With primary circulating pump

TECHNICAL CHARACTERISTICS

- Dimension: DN 20
- Connections:
 - Primary circuit: 3/4" M
 - Heating circuit: 3/4" M
 - Centre distance: 60 mm
- Working max P: 10 bar
- Working max T: 95°C
- Circulating pump: Grundfos UPM3 Hybrid 15-70 Erp ready

Code	Type	Price €	Unit/Box
316 0143	-		1/1

NEW



5585AC

Circulation and biomass plant management unit with plate heat exchanger. With anti-condensation valve and primary circulating pump

TECHNICAL CHARACTERISTICS

- Dimension: DN 20
- Connections:
 - Primary circuit: 3/4" M
 - Heating circuit: 3/4" M
 - Centre distance: 60 mm
- Working max P: 10 bar
- Working max T: 95°C
- Circulating pump: Grundfos UPM3 Hybrid 15-70 Erp ready
- Anti-condensation valve: 60 °C

Code	Type	Price €	Unit/Box
316 0144	-		1/1

06

CLIMAV 2.0 BUILDING MANAGEMENT THERMOREGULATION

06A	Advanced thermoregulation with Climav 2.0 Building Management		166
06B	Climav 2.0 Building Management modules		174
06C	Temperature and humidity probes		182

INTRODUCTION

The Climav 2.0 Building Management system is designed for systems of all types and sizes, whether they work in heating or cooling or with the regulation of different delivery temperatures.

The temperature and humidity environment probes communicate with the control unit via bus or Wi-Fi and are able to detect at any time the different climate changes, self-regulating according to the required temperatures.

HOW IT WORKS

The Climav 2.0 Building Management system is particularly suitable for the management of underfloor and/or ceiling radiant systems in winter and summer operation, ensuring the comfort required by the user in combination with significant energy savings. The high modularity of the regulation system allows the control of different types of building from small residential to tertiary, integrating the necessary energy supply with the management of renewable energy sources and making available the control of different environmental parameters (temperature, relative humidity, etc.) through controlled mechanical ventilation systems.

The thermoregulation system by TIEMME has a number of special features:

- **Easy installation:** the bus connections of the various components of the system are simple and not subordinate to particular logical sequences. This implies a significant reduction in cabling time and where it is not possible to wire probes and modules is available the new Wi-Fi version of the Climav 2.0 Building Management system.
- **Modularity:** the possibility to expand the regulation system allows to adapt it to the specific needs of the plant and to update it to future configurations.
- **Versatility:** the availability of different types of regulation allows the use of the system in a wide variety of buildings while ensuring safety in the management of different plant parameters.
- **Communication:** the management via WEB ensures the use of the system remotely allowing the control, diagnostics, and storage of the system data from remote both user and technical maintenance.
- **Visibility:** the system has a wide range of temperature and temperature/ humidity probes for recessed or outdoor installation all **interfaced** with thermostats environment of different production





WHAT MAKES IT UNIQUE

INTUITIVE TOUCH INTERFACE

The bright colour display allows you to manage in real time, environment by environment, all the features of the system. Just tap the large touchscreen to see the intuitive GUI and start interacting with the system.

CHRONO-PROGRAMMING

The system integrates perfectly with everyone's personal habits. Each room can have its own custom programming for managing parameters and time slots.

MODULARITY

The system adapts perfectly to the specific needs of the house while maintaining the freedom of future expansions in the event of new configurations. Climav 2.0 Building Management is the first system that communicates with the KNX and MODBUS protocol via interface



UNIQUENESS

The quality of Climav 2.0 Building Management is unmatched compared to more traditional regulations such as fixed point or traditional climate. Climav 2.0 Building Management allows you to manage all aspects of air conditioning: heating, cooling, humidity management, ventilation control for air exchange. A superior comfort that has its roots in the correct use of energy and in the optimization of energy and economic expenditure.

MONITORING OF CONSUMPTION

It allows to constantly track the energy consumption of the installed generators allowing to identify any critical factors and allow an improvement.

06_A ADVANCED THERMOREGULATION WITH CLIMAV 2.0 BUILDING MANAGEMENT

APP TO MANAGE YOUR HOME

View and adjust in real time, environment by environment, home well-being, sitting in the car or office simply by touching the display of your smartphone. All this is possible thanks to an app developed by Tiemme for its Climav 2.0 Building Management control system.



ZONE 2  21.0 °C

ZONE 1  22.0 °C



PRICE LIST

06_A ADVANCED THERMOREGULATION WITH CLIMAV 2.0 BUILDING MANAGEMENT

APP TO MANAGE YOUR HOME



APP AVAILABLE FOR BOTH ANDROID AND IOS



EXAMPLES OF THE CONFIGURATION

BASE SYSTEM

Example of small house managed in heating with climate compensation.

The BASE SYSTEM system realized using climate regulator RC_SA art. 5530M5 - 5530M6, allows to manage:

- 1 mixing unit with analog or 3-point servo motor;
- delivery temperature compensation with external probe and internal sensor;
- 1 thermal zone (ambient temperature probe).

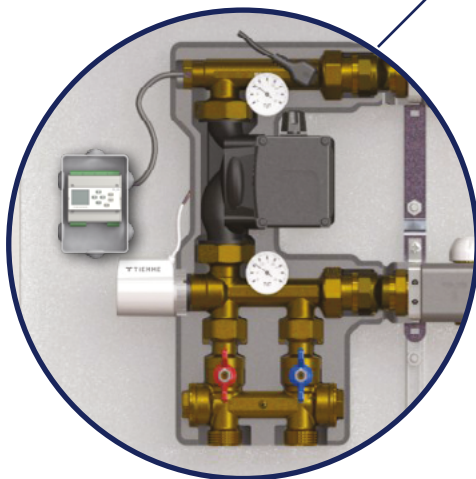

1. Boiler
2. External probe
3. Radiant plant manifold complete with mixing unit
4. Ambient temperature probe

COMPONENTS OF THE SYSTEM



RC_SA
5530M5
5530M6
Climate regulator



T_EXT
5530E
External probe



5530P
Fluid temperature probe

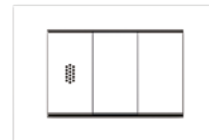

T_P
5530I9
Ambient temperature probe



EXAMPLES OF THE CONFIGURATION

EVO SYSTEM 1

Example of apartment managed in heating.

The EVO SYSTEM 1 system realized using master module MHC BASIC art. 5530M8, allows to manage:

- 1 heat generator operated in hot only;
- 1 distribution unit with mixing;
- 6 thermal zones (temperature probes);
- External probe;
- Delivery probe.



1. Radiant plant manifold complete with mixing unit
2. Ambient temperature probe
3. External probe
4. Boiler

COMPONENTS OF THE SYSTEM

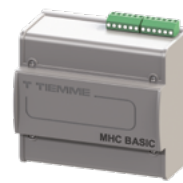

MHC BASIC
5530M8
Master module



T_EXT
5530E
External probe



5530P
Fluid temperature probe

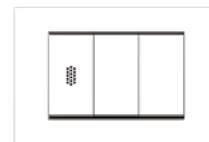

T_P
5530I9
Ambient temperature probe



CLIMAV 6000
5530V
Display



MPW22COM
5530M2COM
Power supply

 The connection between the modules is made with a RS485 serial line.

EXAMPLES OF THE CONFIGURATION

EVO SYSTEM 2

Example of apartment managed in heating/cooling with climate compensation and relative humidity control by dehumidifier.



The EVO SYSTEM 2 system realized using master module MHC art. 5530M1 (or 5530MHCW), allows to manage:

- 2 heat generators operated in hot only or cold only;
- Distribution units with mixing;
- 8 thermal zones (temperature/humidity probes);
- External probe.
- Delivery probe.



1. Radiant plant manifold complete with mixing unit
2. Ambient temperature and relative humidity probe
3. Dehumidifier
4. External probe
5. Boiler + heat pump
6. Ambient temperature probe

ELEMENTS THAT MAKE UP THE WIRED SYSTEM

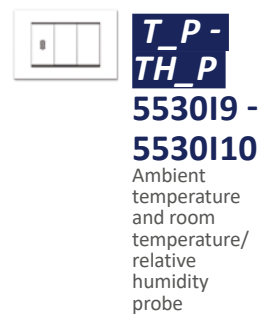
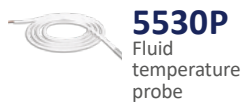

ELEMENTS THAT MAKE UP THE WI-FI SYSTEM



The connection between the modules is made with a RS485 serial line.



EXAMPLES OF THE CONFIGURATION

EVO SYSTEM 3

Example of apartment managed in heating/cooling with climate compensation, relative humidity control by dehumidifier and controlled mechanical ventilation (CMV). The EVO SYSTEM 3 system realized using master module MHC art. 5530M1 (or 5530MHCW), allows to manage:



- 2 heat generators operated in hot only or cold only;
- Distribution units with mixing;
- 8 thermal zones (temperature/humidity probes);
- External probe;
- Delivery probe;
- SFDC slave module management (CMV control).



1. Radiant plant manifold complete with mixing unit
2. Ambient temperature and relative humidity probe
3. Dehumidifier
4. CMV (SFDC module)
5. External probe
6. Boiler + heat pump
7. Ambient temperature probe

ELEMENTS THAT MAKE UP THE WIRED SYSTEM

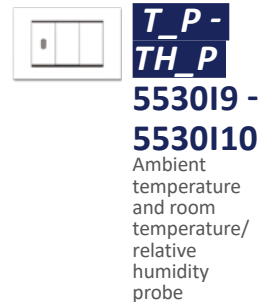
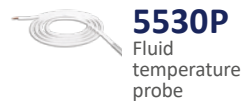

ELEMENTS THAT MAKE UP THE WI-FI SYSTEM

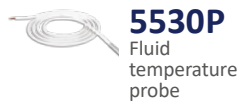

The connection between the modules is made with a RS485 serial line.

CLIMAV 6000W - WI-FI DISPLAY

NEW



5530W

CLIMAV 6000W is the capacitive touchscreen display that represents true innovation in building management.

Connected to the MHCW master unit allows the user to fully control the entire thermoregulation system.

The minimalist aesthetic based on timeless linear shapes makes the design adaptable to any residential or work environment.

The 16:9 4.3" display makes it possible to intuitively exploit the many potential of a smart system. CLIMAV 6000 is equipped with an internal clock and a mini-USB port for software updates. Available in white colour.

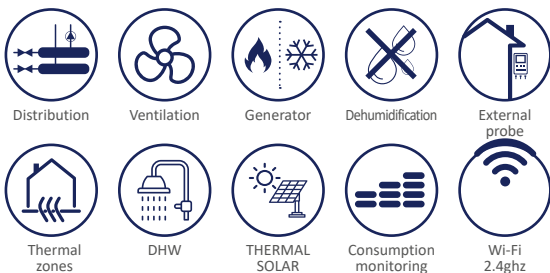

TECHNICAL CHARACTERISTICS

- Voltage: 12-24 Vac / Vdc
- Power consumption: 4 VA
- Internal fuse: 5 A delayed
- Protection category: IP40
- Protection class: II
- Operating Ambient Temperature: 0 ÷ 40 °C
- Operating Ambient Relative Humidity: Up to 85 % at T=25 °C
- Storage Temperature: 0 ÷ 60 °C
- Storage relative humidity: no condensation
- Casing: ABS plastic
- Installation: on the wall
- Display: 4.3" TFT 16:9 colour graphic display
- Programming: touchscreen
- Dimensions (LxHxP): 122 x 88 x 18 mm
- Integrated Wi-Fi communication module – 2,4GHz
- Release automatic updates

Code	Colour	Type	Price €	Unit/Box
555 0353	□ White	Wi-Fi		1/1

MHCW - WI-FI MASTER MODULE

NEW



5530MHCW

Master MHCW Wi-Fi module, 2.4ghz, to be used in the Climav 2.0 Building Management thermoregulation system in combination with the CLIMAV 6000 Wi-Fi display.

The MHCW module is the main element of the system, equipped with a small only display alphanumeric display, programming keypad and three LEDs (blue-yellow-green) reporting the status of the device. This device can be set as: Master MHC, or Slave module. Depending on its configuration it will be able to manage: generators, pumping stations/mixing units, thermal zones, air treatment systems, solar system, DHW systems.

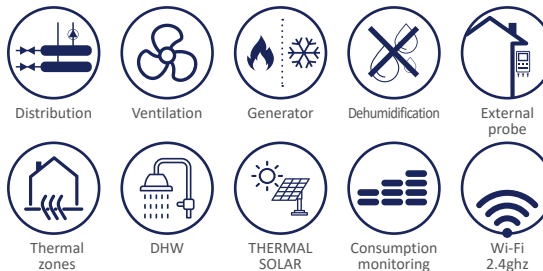

TECHNICAL CHARACTERISTICS

- Input voltage: 12-24 Vac / Vdc
- Power consumption: 7 VA
- Relay contacts range: 6 A 250Vac
- Protection category: IP40
- Protection class: II
- Operating Ambient Temperature: 0 ÷ 40 °C
- Operating Ambient Relative Humidity: Up to 85 % at T=25 °C
- Storage Temperature: 0 ÷ 60 °C
- Storage relative humidity: no condensation
- Casing: ABS plastic
- Installation: on DIN rail (6 modules)
- Integrated Wi-Fi communication module - 2.4GHz
- Display: alphanumeric, 12x2 rows, 3 leds (blue, yellow, green), 3 buttons
- Inputs:
 - 14 Inputs configurable according to the module set
- Outputs:
 - 16 relays configurable according to the module set
- Dimensions (LxHxP): 105 x 95 x 60 mm (6 DIN modules)

i To be connected to the CLIMAV 6000W

Code	Type	Price €	Unit/Box
555 0357	Wi-Fi		1/4



CLIMAV 6000 - DISPLAY



5530V

CLIMAV 6000 is the resistive touchscreen display that represents true innovation in building management.

Connected to the master unit (MHC or MHC BASIC) allows the user complete control of the entire thermoregulation system.

The minimalist aesthetic based on timeless linear shapes makes the design adaptable to any residential or work environment.

The 16:9 4.3" display allows you to intuitively exploit the many potential of a smart system. CLIMAV 6000 is equipped with an internal clock and a mini-USB port for

the software updates. Available in white or black.

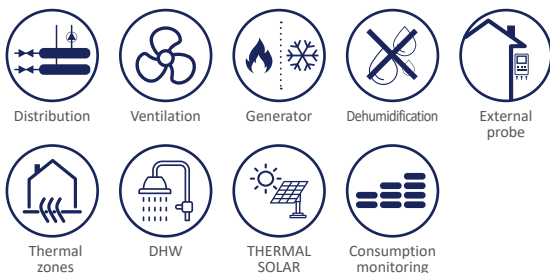

TECHNICAL CHARACTERISTICS

- Voltage: 12-24 Vac / Vdc
- Power consumption: 4 VA
- Internal fuse: 5 A delayed
- Protection category: IP40
- Protection class: II
- Operating Ambient Temperature: 0 ÷ 40 °C
- Operating Ambient Relative Humidity: Up to 85 % at T=25 °C
- Storage Temperature: 0 ÷ 60 °C
- Storage relative humidity: no condensation
- Casing: ABS plastic
- Installation: on the wall
- Display: TFT 4.1" graphic colour display
- Programming: touchscreen
- Dimensions (LxHxP): 122 x 88 x 18 mm

Code	Colour	Type	Price €	Unit/Box
555 0101	White	Wired		1/1
555 0336	Black	Wired		1/1

MHC BASIC - MASTER MODULE

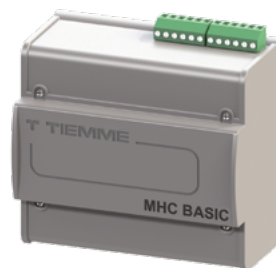

5530M8

MHC BASIC master module for system control. The module can handle 6 thermal zones (Temperature and Temperature/ Humidity), 1 energy source, 1 mixing unit with analog actuator and a dehumidifier (to replace a thermal zone).

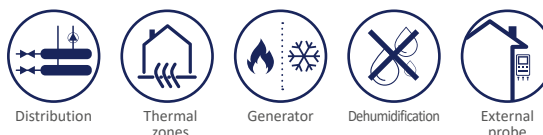

TECHNICAL CHARACTERISTICS

- Voltage: 12-24 Vac / Vdc
- Power consumption: 7 VA
- Relay contacts range: 6 A 250Vac
- Protection category: IP40
- Protection class: II
- Operating Ambient Temperature: 0 ÷ 40 °C
- Operating Ambient Relative Humidity: Up to 85 % at T=25 °C
- Storage Temperature: 0 ÷ 60 °C
- Storage relative humidity: no condensation
- Casing: ABS plastic
- Installation: on DIN rail (6 modules)
- Inputs:
 - 6 inputs for T and T+H environment sensors
 - 2 inputs (NTC) for external probe (T_EXT) and delivery probe (5530P)
- Outputs:
 - 6 relays (1 per zone) for the management of electro-thermal servo control (in case a servo control can be replaced by a dehumidifier)
 - 1 0-10 V or 4-20 mA control (can be set via software) to control the mixing system.
 - 1 relay for activation/deactivation of circulators
 - 1 relay for the activation/deactivation of the energy generator (only hot or only cold)
- Dimensions (LxHxP): 105 x 95 x 60 mm (6 DIN modules)

i To be connected to the CLIMAV 6000.

Code	Type	Price €	Unit/Box
555 0344	-		1/4

MHC - MASTER MODULE



5530M1

Master MHC module to be used in the Climav 2.0 Building Management thermoregulation system in combination with the CLIMAV 6000.

The MHC module is one of the main elements of the system and is equipped with a small graphic display only display and three LEDs showing the operating status of the device.

The module allows the management of 8 thermal zones/ dehumidifiers, 4 distribution/mixing groups with analog actuator and 2 energy generators (only hot or only cold). You can then expand the functions managed by connecting additional slave modules via bus.



TECHNICAL CHARACTERISTICS

- Input voltage: 12-24 Vac / Vdc
- Power consumption: 7 VA
- Relay contacts range: 6 A 250Vac
- Protection category: IP40
- Protection class: II
- Operating Ambient Temperature: 0 ÷ 40 °C
- Operating Ambient Relative Humidity: Up to 85 % at T=25 °C
- Storage Temperature: 0 ÷ 60 °C
- Storage relative humidity: no condensation
- Casing: ABS plastic
- Installation: on DIN rail (6 modules)
- Display: Graphic display, 16x2 rows, 3 leds (red, yellow, green), 3 buttons
- Inputs:
 - 8 inputs for T and T+H environment sensors
 - 2 inputs (NTC) for external probe (T_EXT) and delivery probe (5530P)
 - 1 digital input for season switching (summer/winter)
 - 3 impulse inputs for consumption monitoring
- Outputs:
 - 8 relays (1 per zone) for the management of electro-thermal servo controls
 - 4 0-10 V or 4-20 mA controls (can be set via software) to control the mixing system
 - 4 relay for activation/deactivation of circulators
 - 2 relays for the activation/deactivation of the energy generators (only hot or only cold or both)
 - 1 relay for season change reporting
- Dimensions (LxHxP): 105 x 95 x 60 mm (6 DIN modules)

Code	Colour	Type	Price €	Unit/Box
555 0106	-	Wired		1/1

SFDC - SLAVE MODULE



5530S7

The SFDC slave module allows the control of 2 fan coils (if no electronics on board) or a complete Mechanically Controlled ventilation unit (MCV) (dehumidification, renewal, integration).



TECHNICAL CHARACTERISTICS

- Input voltage: 12-24 Vac / Vdc
- Power consumption: 7 VA
- Relay contacts range: 6 A 250Vac
- Protection category: IP40
- Protection class: II
- Operating Ambient Temperature: 0 ÷ 40 °C
- Operating Ambient Relative Humidity: Up to 85 % at T=25 °C
- Storage Temperature: 0 ÷ 60 °C
- Storage relative humidity: no condensation
- Casing: ABS plastic
- Installation: on DIN rail (6 modules)
- Inputs:
 - 1 request renewal bathrooms (clean contact)
 - 1 unit fault (clean contact)
- Outputs:
 - 1 summer/winter switching relay
 - 1 dehumidification required relay
 - 1 renewal required relay
 - 1 bathrooms renewal required relay (clean contact)
 - 1 on/off unit relay
 - 1 integration required relay
 - 1 ventilation required relay
 - 1 battery valve modulation
- Dimensions (LxHxP): 105 x 95 x 60 mm (6 DIN modules)

For the management of the MCV

Code	Type	Price €	Unit/Box
555 0119	-		1/4



SZC - SLAVE MODULE



5530S4

The SZC slave module expands and integrates the basic functions of the MHC master module allowing the management of 8 additional thermal zones. In particular, it allows the connection of 8 additional Temperature and/or Temperature/Humidity probes and the consequent control of the electro-thermal servo controls.



Thermal zones



Dehumidification

TECHNICAL CHARACTERISTICS

- Input voltage: 12-24 Vac / Vdc
- Power consumption: 7 VA
- Relay contacts range: 6 A 250Vac
- Protection category: IP40
- Protection class: II
- Operating Ambient Temperature: 0 ÷ 40 °C
- Operating Ambient Relative Humidity: Up to 85 % at T=25 °C
- Storage Temperature: 0 ÷ 60 °C
- Storage relative humidity: no condensation
- Casing: ABS plastic
- Installation: on DIN rail (6 modules)
- 8 inputs for T and T+H environment sensors
- 8 Outputs relays (1 per zone) for the management of electro-thermal servo controls
- Dimensions (LxHxP): 105 x 95 x 60 mm (6 DIN modules)

i 8 thermal zones for expansion

Code	Type	Price €	Unit/Box
555 0116	-		1/4

SBC - SLAVE MODULE



5530S5

The SBC slave module expands and integrates the basic functions of the MHC master module allowing the management of 3 additional thermal generators/refrigerators. In particular, it can manage their activation/deactivation, the priority of operation, their set-point and any alarms.



Generator

TECHNICAL CHARACTERISTICS

- Input voltage: 12-24 Vac / Vdc
- Power consumption: 7 VA
- Relay contacts range: 6 A 250Vac
- Protection category: IP40
- Protection class: II
- Operating Ambient Temperature: 0 ÷ 40 °C
- Operating Ambient Relative Humidity: Up to 85 % at T=25 °C
- Storage Temperature: 0 ÷ 60 °C
- Storage relative humidity: no condensation
- Casing: ABS plastic
- Installation: on DIN rail (6 modules)
- Inputs
 - 3 generators activators inputs
 - 3 generator alarms inputs (clean contact)
 - 6 inputs (NTC) for generator supply/return probes
- Outputs:
 - 3 generator activation command relay
 - 3 switching generators relay
 - 2 setpoint generators activation outputs
- Dimensions (LxHxP): 105 x 95 x 60 mm (6 DIN modules)

i For up to 3 thermal generators/refrigerators

Code	Type	Price €	Unit/Box
555 0117	-		1/4

SSCC - SLAVE MODULE



5530S6

The SSCC slave module expands and integrates the basic functions of the MHC master module allowing the management of the thermal solar system. In particular, it allows the programming of 8 different schemes, the management of the plant protections, the management of accumulations and circulation pumps.



Thermal solar

TECHNICAL CHARACTERISTICS

- Input voltage: 12-24 Vac / Vdc
- Power consumption: 7 VA
- Relay contacts range: 6 A 250Vac
- Protection category: IP40
- Protection class: II
- Operating Ambient Temperature: 0 ÷ 40 °C
- Operating Ambient Relative Humidity: Up to 85 % at T=25 °C
- Storage Temperature: 0 ÷ 60 °C
- Storage relative humidity: no condensation
- Casing: ABS plastic
- Installation: on DIN rail (6 modules)
- Inputs:
 - 4 motorized end stroke valves
 - 2 thermal solar circulation pumps thermal protection inputs
 - 9 temperature probes inputs (PT1000)
- Outputs:
 - 4 control relays for motorized valves
 - 2 control relays for solar circulation pumps
 - 2 analog controls for solar circulation pumps
- Dimensions (LxHxP): 105 x 95 x 60 mm (6 DIN modules)

i For the management of the thermal solar system

Code	Type	Price €	Unit/Box
555 0118	-		1/4

SMC - SLAVE MODULE



5530S1

The SMC slave module expands and integrates the basic functions of the MHC master module allowing the management of 4 additional analog mixers. In particular it manages their command (0-10 Vdc or 4-20 mA), set-point temperatures and their circulation pumps.



Distribution

TECHNICAL CHARACTERISTICS

- Input voltage: 12-24 Vac / Vdc
- Power consumption: 7 VA
- Relay contacts range: 6 A 250Vac
- Protection category: IP40
- Protection class: II
- Operating Ambient Temperature: 0 ÷ 40 °C
- Operating Ambient Relative Humidity: Up to 85 % at T=25 °C
- Storage Temperature: 0 ÷ 60 °C
- Storage relative humidity: no condensation
- Casing: ABS plastic
- Installation: on DIN rail (6 modules)
- Inputs:
 - 4 inlet for circulation pumps (clean contact)
 - 4 inputs for flow temperature probes (NTC)
- Outputs:
 - 4 activation/deactivation relays for circulation pumps
 - 4 analog controls (0-10 V or 4-24 mA) for the modulation of mixers
- Dimensions (LxHxP): 105 x 95 x 60 mm (6 DIN modules)

i For expansion no. 4 mixers with analog actuator

Code	Type	Price €	Unit/Box
555 0114	-		1/4



SMRC - SLAVE MODULE



5530S2

The SMRC slave module expands and integrates the basic functions of the MHC master module allowing, through the programming of the 8 internal relays, the management of 4 mixing groups with 3-point actuator or 2 twin circulators.



Distribution

TECHNICAL CHARACTERISTICS

- Input voltage: 12-24 Vac / Vdc
- Power consumption: 7 VA
- Relay contacts range: 6 A 250Vac
- Protection category: IP40
- Protection class: II
- Operating Ambient Temperature: 0 ÷ 40 °C
- Operating Ambient Relative Humidity: Up to 85 % at T=25 °C
- Storage Temperature: 0 ÷ 60 °C
- Storage relative humidity: no condensation
- Casing: ABS plastic
- Installation: on DIN rail (6 modules)
- Outputs: 8 relays for opening/closing of 3-points mixers or 8 relays for the ON/OFF control of 2 twin pumps
- Dimensions (LxHxP): 105 x 95 x 60 mm (6 DIN modules)

i For the management of 4 mixers with 3-point actuator or twin circulators

Code	Type	Price €	Unit/Box
555 0154	-		1/4

SDHW - SLAVE MODULE

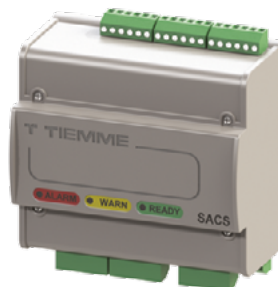

5530S3

The SACS slave module expands and integrates the basic functions of the MHC master module allowing the management of the domestic hot water (DHW) storage system. In particular, it manages the temperature and safety of the accumulation, the delivery temperature of the DHW, the recirculation, the anti-legionella cycle and any integration by means of electrical resistance.



DHW

TECHNICAL CHARACTERISTICS

- Input voltage: 12-24 Vac / Vdc
- Power consumption: 7 VA
- Relay contacts range: 6 A 250Vac
- Protection category: IP40
- Protection class: II
- Operating Ambient Temperature: 0 ÷ 40 °C
- Operating Ambient Relative Humidity: Up to 85 % at T=25 °C
- Storage Temperature: 0 ÷ 60 °C
- Storage relative humidity: no condensation
- Casing: ABS plastic
- Installation: on DIN rail (6 modules)
- Inputs:
 - 1 DHW tank safety thermostat input (clean contact)
 - 1 recirculation pump heat protection inlet
 - 1 resistance thermal protection input
 - 4 inputs (NTC) for accumulation probes (upper and lower) of delivery and return
 - 1 input (NTC) to manage generator priority
- Outputs:
 - 1 recirculation pump activation relay
 - 2 relays to activate electrical resistances
 - 1 cycle anti-legionella active warning output
 - 2 3-points mixer control relay
 - 1 control output for DHW mixer
- Dimensions (LxHxP): 105 x 95 x 60 mm (6 DIN modules)

i For DHW production plant management

Code	Type	Price €	Unit/Box
555 0115	-		1/4

SKNX - SLAVE MODULE



5530S10

The Domotics SKNX bus adapter allows interfacing with the most common communication protocols in the home automation environment. The SKNX module allows interaction between the various subsystems of the building by operating on KONNEX bus networks. To be combined with the GATEWAY module.



Domotics KNX

TECHNICAL CHARACTERISTICS

- Input voltage: 12-24 Vac / Vdc
- Power consumption: 7 VA
- Protection category: IP40
- Protection class: II
- Operating Ambient Temperature: 0 ÷ 40 °C
- Operating Ambient Relative Humidity: Up to 85 % at T=25 °C
- Storage Temperature: 0 ÷ 60 °C
- Storage relative humidity: no condensation
- Casing: ABS plastic
- Installation: on DIN rail (2 modules)
- Ports:
 - RS232 standard for interface with GATEWAY module
 - KNX bus connector (signal + power supply)

i To communicate with Konnex networks

Code	Type	Price €	Unit/Box
555 0320	-		1/10

GATEWAY - SLAVE MODULE



5530S11

The GATEWAY slave module allows the remote management of the entire advanced thermoregulation system Climav 2.0 Building Management by means of the APP (available for Android and IOS).

It is also indispensable for interfacing with external systems based on MODBUS and, in combination with the SKNX module, on KONNEX systems. In combination filter for LAN networks complete with grounding.



Control by remote

Domotics KNX



TECHNICAL CHARACTERISTICS

Gateway

- Input voltage: 12-24 Vac / Vdc
- Power consumption: 7 VA
- Protection category: IP40
- Protection class: II
- Operating Ambient Temperature: 0 ÷ 40 °C
- Operating Ambient Relative Humidity: Up to 85 % at T=25 °C
- Storage Temperature: 0 ÷ 60 °C
- Storage relative humidity: no condensation
- Casing: ABS plastic
- Installation: on DIN rail (2 modules)
- Ports:
 - WiBus on network 485 for CLIMAV interface
 - RS232 standard for KNX, MODBUS interface
 - Ethernet RJ45 10/100 Mb

LAN filter

- Bidirectional filter with double internal protection to safeguard the Gateway module from voltage inputs from the internet network.
- Grounding cable.

i To communicate remotely with the Climav 2.0 Building Management system

Code	Colour	Type	Price €	Unit/Box
555 0346	-	Ethernet		1/1



MPW22COM - POWER SUPPLY



5530M2COM

240vac/24V power supply for the entire Climav 2.0 Building Management thermoregulation system.

TECHNICAL CHARACTERISTICS

- Input voltage: 100 ÷ 240 Vac - 1.8A - 50 ÷ 60 Hz
- Output voltage: 24V
- Output voltage range: 21.6...29V
- Output current: 2.5A
- Power consumption: 60 W
- No load power consumption: <0.3W
- Electronic protections: SCP anti short circuit, OPP overload, OVP over current
- Category of overvoltage: III
- Insulation class: II
- Operating Ambient Temperature: -30 ÷ 70 °C
- Working humidity: 20-90% non-condensing
- Installation: on DIN rail (3 modules)
- Dimensions (LxHxP): 52.5 x 90 x 58.4 mm (4 DIN modules)

Code	Colour	Type	Price €	Unit/Box
555 0338	-	Output 24V		1/1

RC_SA - CLIMATE REGULATOR



5530M5 5530M6

The RC_SA climate regulator allows the regulation of the temperature of the carrier fluid in heating and air conditioning systems, by managing a mixing valve with proportional or three points servo motor.

DESCRIZIONE

The controller allows the following modes of carrier fluid temperature management:

- climate compensation by the installation of an external probe;
- climate compensation by the installation of an external probe and an ambient probe;
- compensation by analysis of the system return temperature (in heating only).

Depending on the devices connected, it is possible to control one or two separate thermal zones and activate a dehumidifier with neutral air.

TECHNICAL CHARACTERISTICS

- Power supply: 85 ÷ 230 Vac 50/60 Hz or 24 Vac
- Power consumption: 5 W
- Protection fuse: 1 A
- Graphic display: 1,8" colour
- Dimensions : no. 6 modules for DIN rail installation
- Programming: 7 buttons keyboard
- Inputs:
 - Thermostats cumulative input
 - Summer-winter remote switching input
 - Remote ON/OFF input
 - Ambient probe system Climav 2.0 Building Management
 - External probe 5530E
 - Delivery probe 5530P
 - Return probe 5530P
- Outputs:
 - 1 ON/OFF contact for circulation pump activation
 - 1 ON/OFF contact for dehumidifier control
 - 1 ON/OFF contact for thermal zone activation
 - 0-10 V for proportional servo motor control
 - 2 ON/OFF contacts for 3-point servo motor control
- Dimensions (LxHxP): 105 x 95 x 60 mm (6 DIN modules)

For the climatic regulation of the system

Code	Power supply	Price €	Unit/Box
Art. 5530M5			
555 0302	85-230 Vac		1/4
Art. 5530M6			
555 0304	24 Vac		1/4

T_EXT



5530E

External temperature and humidity probe.

Used in the Climav 2.0 Building Management thermoregulation system for compensation in climate regulation.

TECHNICAL CHARACTERISTICS

- Resistance: 10Kohm to 25 °C
- Class of protection: II
- Casing: ABS plastic
- Installation: on the wall
- Category of protection: IP54
- Measuring range: -40 ÷ +110 °C
- Outdoor ambient temperature: 15 ÷ 55 °C
- External ambient relative humidity: Up to 85 % at T=25 °C
- Storage Temperature: 0 ÷ 60 °C
- Storage relative humidity: no condensation
- Dimensions : 74 x 109 x 59 mm

Code	Type	Price €	Unit/Box
555 0145	-		1/4



5530P

NTC temperature probe 10KΩ @ 25°C, 6 mm diameter

Code	Type	Price €	Unit/Box
555 0149	-		1/10



TH_G



5530E1
Ambient temperature/humidity
probe wall installation

TECHNICAL CHARACTERISTICS

- Dimensions (LxHxP): 120 x 80 x 20 mm

i Place in any room and connect to the Climav 2.0 Building Management system.

Code	Colour	Type	Price €	Unit/Box
555 0139	□ White	Wired		1/4
555 0340	■ Black	Wired		1/4

T_G



5530E2
Ambient temperature probe
wall installation

TECHNICAL CHARACTERISTICS

- Dimensions (LxHxP): 120 x 80 x 20 mm

i Place in any room and connect to the Climav 2.0 Building Management system.

Code	Colour	Type	Price €	Unit/Box
555 0140	□ White	Wired		1/4
555 0342	■ Black	Wired		1/4

TH_P

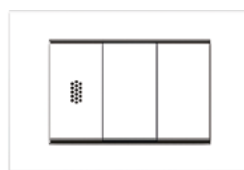

5530I10
Built-in temperature/humidity
ambient probe.

TECHNICAL CHARACTERISTICS

- Made according to the civil series installed

i To be placed in box 503. Indicate to Tiemme technician the civil series used (e.g. Vimar Idea, Piana, Bticino Light, Light Tech, etc.) in order to respect the aesthetics of the house.

i Place in any room and connect to the Climav 2.0 Building Management system.

Code	Colour	Type	Price €	Unit/Box
555 0329	-	Wired		1/1

T_P

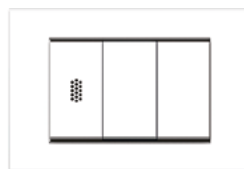

5530I9
Built-in temperature ambient
probe.

TECHNICAL CHARACTERISTICS

- Made according to the civil series installed

i To be placed in box 503. Indicate to Tiemme technician the civil series used (e.g. Vimar Idea, Piana, Bticino Light, Light Tech, etc.) in order to respect the aesthetics of the house.

i Place in any room and connect to the Climav 2.0 Building Management system.

Code	Colour	Type	Price €	Unit/Box
555 0327	-	Wired		1/1



TH_W

NEW



5530E3W

TH temperature and humidity probe, Wi-Fi with LCD with Touch Panel.



Wi-Fi
2.4ghz

TECHNICAL CHARACTERISTICS

- Dimensions (LxHxP): 120 x 80 x 20 mm
- Large colour LCD display (VA) with polished glass
- Touch with high touch sensitivity
- Radar system of presence
- Battery power supply (2xaaa)
- Power supply from CLIMAV bus
- General power supply 12/24vdc
- Data connection via 2.4 GHz Wi-Fi
- Data connection via CLIMAV bus

 Stand-Alone Probe

 Can be integrated with Climav 2.0 Building Management system. and with GATE system

Code	Colour	Type	Price €	Unit/Box
555 0356	■ Black	Wired/Battery		1/4



07 TEMPERATURE CONTROLS

07A Thermostats and chronothermostats



186

07B Wireless temperature controls



186

07C Wi-Fi temperature controls **TIEMME** *NEXT* >>



188



9573
Built-in electronic room thermostat

TECHNICAL CHARACTERISTICS

- Power supply: 2 AAA batteries 1.5 V
- Output: Voltage free exchange relay 8(5) A/250 Vac
- Function: SUMMER-WINTER-OFF
- Adjustment range: 2-50°C
- Minimum switching time: 1 minute
- Differential: adjustable from 0.1 to 1 °C

Thanks to the different mounting frames supplied, it is possible to adapt the thermostat to the most common plates, integrating it perfectly with the civil series used.

Code	Type	Price €	Unit/Box
957 0008	electronic		1/5



9574
Weekly built-in digital thermostat

TECHNICAL CHARACTERISTICS

- Power supply: 2 AAA batteries 1.5 V
- Output: Voltage free exchange relay 8(5) A/250 Vac
- Function: SUMMER-WINTER
- Adjustment range: 2-50°C
- Daily resolution: 1 hour
- Differential: adjustable from 0.1 to 1 °C

Thanks to the different mounting frames supplied, it is possible to adapt the thermostat to the most common plates, integrating it perfectly with the civil series used.

Code	Type	Price €	Unit/Box
957 0015	weekly electronic		1/5



4601
Wireless touchscreen electronic room thermostat

TECHNICAL CHARACTERISTICS

- Display touchscreen
- Power supply: 2 1.5V mini stylus batteries (type AAA)
- Battery life: 1 year
- Transmission frequency: 433,92 MHz
- Function: SUMMER-WINTER-OFF
- Adjustment range: 2-50°C
- Differential: adjustable from 0.1 to 1 °C

Code	Type	Price €	Unit/Box
957 0156	electronic		1/10

ART. 4606 OPERATION

The load (air conditioner, boiler, etc.) is activated via the remote receiver, which is remotely controlled by the thermostat (included in the kit) through a radio frequency signal. In this way it is possible to place the thermostat anywhere in the house, without any wiring.



4606
Wireless temperature control system consisting of touchscreen thermostat + 1 channel receiver

TECHNICAL CHARACTERISTICS

- THERMOSTAT**
- see technical characteristics art. 4601
- RECEIVER**
- see technical characteristics art. 4607

Code	Type	Price €	Unit/Box
957 0157	electronic		1/4

For the complete range see the catalogue "Hydraulic components"



ART. 4607 OPERATION

The load (air conditioner, boiler, etc.) is activated via the remote receiver, which is remotely controlled by the thermostat/chronothermostat (ordered separately) through a radio frequency signal. In this way it is possible to place the thermostat anywhere in the house, without any wiring.



4607

1 channel radio receiver with control for boiler/ heat pump/ circulator

TECHNICAL CHARACTERISTICS

- Power supply: 230 Vac 50 Hz
- Version 2 DIN modules
- Output: 8 A (230 Vac) voltage free exchange relay

Code	Type	Price €	Unit/Box
957 0183	electronic		1/25

ART. 4612 OPERATION

It is designed to drive air conditioning equipment (hot/cold) by receiving the control signals from the wireless thermostats/chronothermostats (ordered separately) through a radio frequency signal. It has 6 relays to control up to 6 zone valves plus an additional relay for connection to the circulation pump that automatically switches when at least one of the 6 outputs is active. It is possible to delay the activation of this last command (from 3 seconds to 5 minutes) by means of the trimmer placed on the front



4612

6-channel radio receiver with control for electrothermic actuators art. 9567

TECHNICAL CHARACTERISTICS

- Power supply: 230 Vac 50 Hz
- Number of channels: 6
- Actuator control: 5 A (230 Vac) relay contact
- Pump control: 5 A (230 Vac) relay contact
- Pump control delay can be set from 3 seconds to 5 minutes
- External antenna included in the package
- Version 4 DIN modules

Code	Type	Price €	Unit/Box
957 0158	electronic		1/4

4601-4612-9567

EXAMPLE OF INSTALLATION

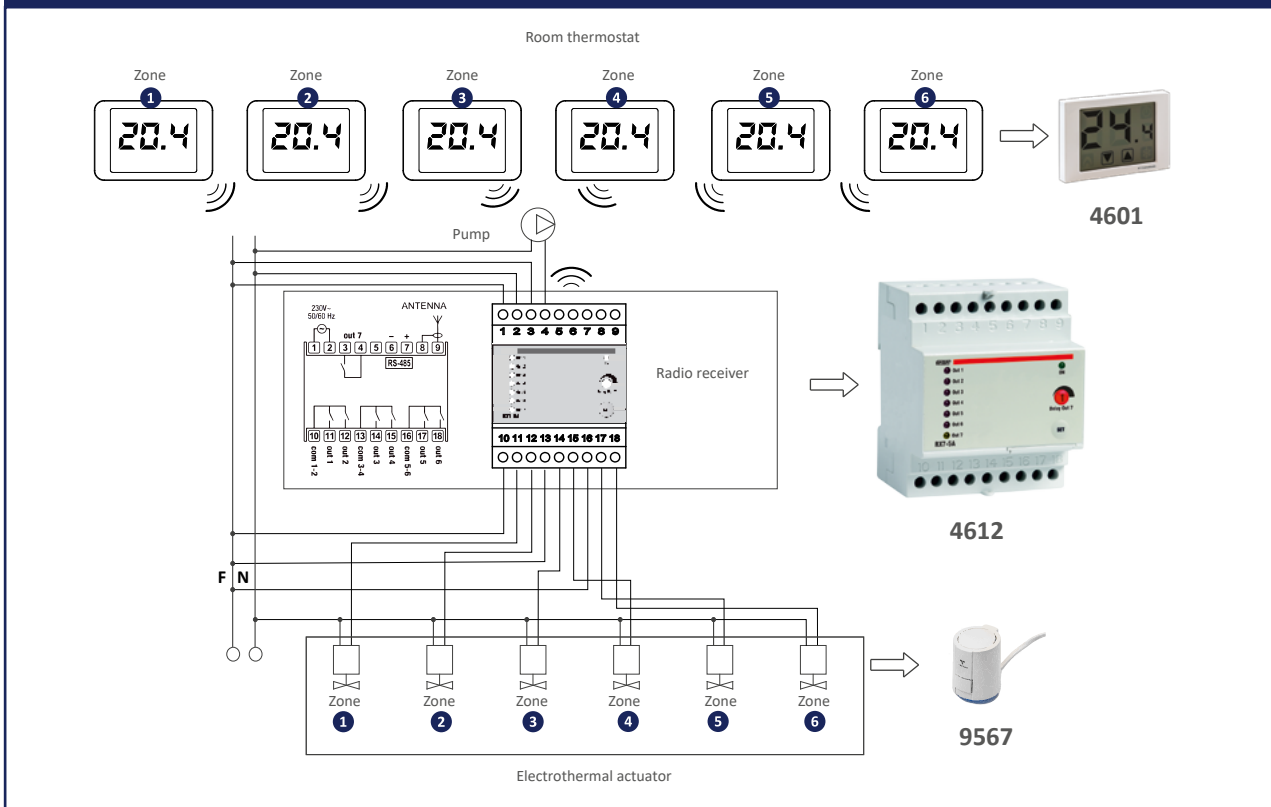

The digital electronic thermostats with Wi-Fi communication are able to remotely manage the air conditioning of the rooms via App.

The integrated Wi-Fi module allows you to control the thermostat remotely with your smartphone. Simply connect your device to your home router and install the TIEMME NEXT app on your smartphone, which is available free of charge for iOS and Android devices.

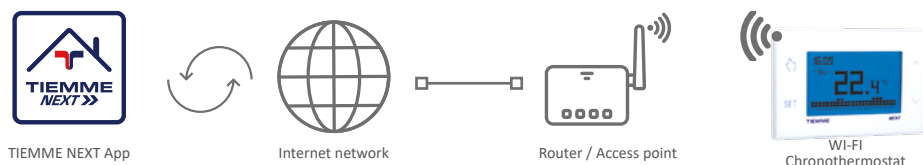

Available for



9589
Wall-mounted weekly thermostat TIEMME NEXT white colour. Wi-Fi communication.

TECHNICAL CHARACTERISTICS

- Power supply: 230Vac ± 10% 50/60 Hz/ 4 1.5V batteries (AA type)
- Output: 5 A (250 Vac) voltage free exchange relay
- Function: Winter/Summer/Off
- Programming: Weekly with 3 temperature levels (T1 - T2 - T3)
- Adjustment range: 2,0 ÷ 50,0 °C
- Temperature regulation: ON/OFF with adjustable differential (0.1 ÷ 1.0 °C) or proportional with adjustable band
- Wi-Fi module for connection with TIEMME NEXT App
- Installation: Wall mounted 130 x 85 thck.28 mm

Code	Type	Price €	Unit/Box
957 0201	230 Vac		1/10
957 0211	4 x 1,5 V AA		1/10



9591
Built-in weekly thermostat (rectangular box) TIEMME NEXT IN. Wi-Fi communication

TECHNICAL CHARACTERISTICS

- Power supply: 230Vac ± 10% 50/60 Hz
- Output: 5 A (250 Vac) voltage free exchange relay
- Function: Winter/Summer/Off
- Programming: Weekly with 3 temperature levels (T1 - T2 - T3)
- Adjustment range: 2,0 ÷ 50,0 °C
- Temperature regulation: ON/OFF with adjustable differential (0.1 ÷ 1.0 °C) or proportional with adjustable band
- Wi-Fi module for connection with TIEMME NEXT App
- Installation: built-in (2 modules) in the main civil series (Bticino, Vimar, Ave, Gewiss)

Code	Type	Price €	Unit/Box
957 0205	230 Vac		1/5

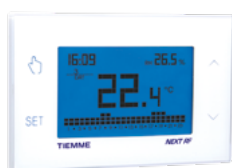

9590
Weekly wall thermostat with humidity sensor TIEMME NEXT RF white colour. Wi-Fi and RF communication (radio frequency)

TECHNICAL CHARACTERISTICS

- Power supply: 230Vac ± 10% 50/60 Hz
- Function: Winter/Summer/Off
- Programming: Weekly with 3 temperature levels (T1 - T2 - T3)
- Adjustment range: 2,0 ÷ 50,0 °C
- Temperature regulation: ON/OFF with adjustable differential (0.1 ÷ 1.0 °C) or proportional with adjustable band
- Wi-Fi module for connection with TIEMME NEXT App
- Radio Frequency module for the management of 3 commands (Temperature/Humidity/VMC)
- Frequency band: 433,92 MHz
- Installation: Wall mounted 130 x 85 thck.28 mm

With humidity sensor

With integrated radio frequency module for communication with radio receiver art. 4607 - 4612 or thermostatic head art. 9556W

Code	Type	Price €	Unit/Box
957 0203	230 Vac		1/10



9592
Built-in weekly thermostat (round box) TIEMMENEXT RD. Wi-Fi communication

TECHNICAL CHARACTERISTICS

- Power supply: 230Vac ± 10% 50/60 Hz
- Output: 5 A (250 Vac) voltage free exchange relay
- Function: Winter/Summer/Off
- Programming: Weekly with 3 temperature levels (T1 - T2 - T3)
- Adjustment range: 2,0 ÷ 50,0 °C
- Temperature regulation: ON/OFF with adjustable differential (0.1 ÷ 1.0 °C) or proportional with adjustable band
- Wi-Fi module for connection with TIEMME NEXT App
- Installation: built-in (round box 60 mm centre distance)

Code	Type	Price €	Unit/Box
957 0207	230 Vac		1/5



PRICE LIST

08A Dehumidifiers

Dehumidifiers - introduction		191
Dehumidifiers for ceiling installation		192
Dehumidifiers for wall built-in installation		194
Dehumidifiers for wall installation		198



08B Controlled mechanical ventilation

Controlled mechanical ventilation (CMV) - introduction		200
Decentralized CMV - residential		201
Decentralized CMV - TERTIARY/EDUCATION		202
Ceiling installation CMV - residential		204
Wall built-in installation CMV - residential		208
Wall/floor installation CMV - residential		210
Ceiling installation CMV - TERTIARY		212
Wall/floor installation CMV - TERTIARY		214





08C Dehumidifiers with CMV

Dehumidifiers with CMV - introduction		216
Dehumidifiers with CMV ceiling installation		218
Dehumidifiers with CMV wall/floor installation		220





08D Dehumidifiers with CMV with hydronic battery for heating and cooling

Dehumidifiers and hydronic battery with CMV - introduction		222
Dehumidifiers and hydronic battery with CMV ceiling installation		224
Dehumidifiers and hydronic battery with CMV wall/floor installation		226

08E Fan coil units for heating and cooling

Fan coil units - introduction		228
Ductable multi-zone fan coil units		230
Fan coil units wall/floor installation		232
Fan coil units wall mounted reversible installation		234
Fan coil units wall mounted installation		236

08F Post heating and post cooling batteries

Post heating/cooling batteries - introduction		238
Electric post heating batteries		239
Hydraulic post heating batteries		240
Insulated batteries for post-heating and cooling		241
Overview of ventilation unit controls		242

08G Air distribution

ACCESSORIES		244
-------------	---	-----

The dehumidifiers of the GH (ceiling horizontal installation unit), FH (vertical installation built-in unit) and FHD (vertical installation design unit) series are designed to be combined with radiant panel cooling systems. These units have been built to ensure dehumidification both in conditions of thermally neutral air, that is without a change of temperature of the air taken, and in conditions of cooled air.

The air flows are deliberately reduced in order to avoid the annoying air currents typical of traditional air conditioning systems.

The GH, FH and FHD series units proposed by TIEMME have the following characteristics:

- are produced in hot-dip galvanized sheet to ensure the best corrosion resistance. The carpentry is self-supporting and equipped with removable panels that facilitate the inspection and maintenance of internal components. The condensate collection basin is standard on all units and is made of stainless steel;
- condensing and evaporating batteries, as well as pre and post treatment water batteries, are made of copper pipes and aluminium fins. The geometry of these heat exchangers allows a low pressure drop value on the air side and therefore the possibility of using low-speed fans with a consequent reduction in the noise of the machine;
- the delivery fan is of the EC brushless double suction centrifugal type;
- coarse filter with low pressure drops, easily removable on the recirculation area;
- available according to the models in 3 different dimensions (200 m³/h, 300 m³/h and 500 m³/h), 3 different types of installation (horizontal ceiling, vertical built-in and vertical installation design) and 2 different operating modes (cold air and neutral air).

DEHUMIDIFIERS IN NEUTRAL/COLD AIR

All FH and GH series dehumidifiers can be operated without the use of pre- and post-cooling water batteries. This function is very useful in case dehumidification is required in the intermediate seasons or the chiller is turned off. In the absence of cold water, the outlet air will be warmer than the air entering the unit.

WARNING: Cold air versions can only work if they are powered by the water in the system (normally supplied at a temperature of 15 °C).

In the absence of water, the units will be switched off by the safety devices connected to them.

GH (CEILING HORIZONTAL INSTALLATION UNIT)



FH (VERTICAL INSTALLATION BUILT-IN UNIT)

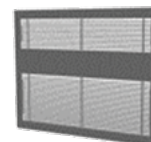
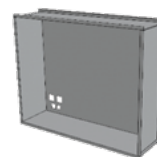
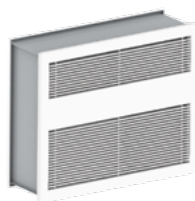
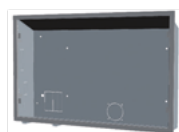

FHD (VERTICAL INSTALLATION DESIGN UNIT)



PRODUCT RANGE



5600GH 5600GHWZ

Dehumidifiers in neutral/cold air, 300 m³/h and 500 m³/h flow rate, horizontal ceiling installation

Code	Model	Type	Price €	Unit/Box
558 0399	00GH-300	Neutral air		1/1
558 0400	00GH-500	Neutral air		1/1
558 0401	00GH-300-WZ	Cold air		1/1
558 0402	00GH-500-WZ	Cold air		1/1

CONTROLS



9683CU

Code	Colour	Price €	Unit/Box
957 0213	Wi-Fi Black		1/1
957 0212	Wi-Fi White		1/1

PRINCIPLE OF OPERATION

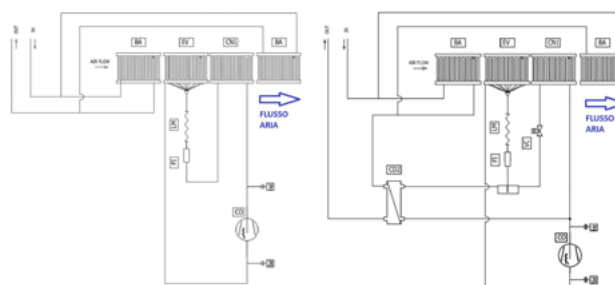

DIMENSIONAL AND TECHNICAL CHARACTERISTICS

DIMENSIONAL CHARACTERISTICS		Codes			
		558 0399	558 0400	558 0401	558 0402
Length	mm	690	800	690	800
Depth	mm	690	690	690	690
Height	mm	250	310	250	310
Air delivery	mm	350 x 180	520 x 250	350 x 180	520 x 250
Air intake	mm	350 x 180	520 x 250	350 x 180	520 x 250
Water unions		1/2" - 1/2"	1/2" - 1/2"	1/2" - 1/2"	1/2" - 1/2"
Condensation drain	mm	16	16	16	16
Weight	kg	40	53	42	55

TECHNICAL CHARACTERISTICS		558 0399	558 0400	558 0401	558 0402
Type of fans		Brushless Electronic motor directly coupled			
Air flow rate	m ³ /h	300	500	300	500
Useful pressure	Pa	150	98	150	98
Useful dehumidifying capacity ¹	l/24h	18,9	36,2	18,9	36,2
Hydronic battery cooling capacity yield ²	W	580	1220	-	-
Cooling capacity perceivable yield	W	-	-	770	1440
Cooling capacity total yield	W	-	-	1270	2390
Heat output yield ³		620	1300	620	1300
Water flow rate	m ³ /h	0,15	0,30	0,15	0,30
Battery pressure drop	Kpa	4,5	9,0	4,5	9,0
Filter type - filtration class		Flat filters - Coarse			
Average sound pressure Lp at 3 metres	dB(A)	36	38	36	38
Supply voltage	V	230 / 1 / 50 Hz			
Absorbed current	A	3,2	5,3	3,2	5,3
Degree of protection		IP20			

¹ Ambient temperature 26°C; relative humidity 65%, Nominal air flow; Water in 16°C;

² Ambient temperature 26°C; relative humidity 65%, Nominal air flow; Water in 16°C;

³ Ambient temperature 20°C; relative humidity 60%, Nominal air flow; Water in 35°C; Acoustic data related to UNI EN 3741 and UNI EN 3744



PRICE LIST

ACCESSORIES

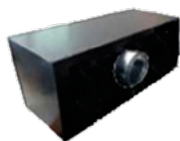

5601PGH

Plenum with single or double connection for direct connection to air distribution terminals or multiple distributor COMBO

Code	Connection	Fan unit	Price €	Unit/Box
558 0428	1 x Ø200 mm	00GH-300 (WZ)		1/1
558 0429	2 x Ø160 mm	00GH-300 (WZ)		1/1
558 0432	1 x Ø200 mm	00GH-500 (WZ)		1/1
558 0433	2 x Ø160 mm	00GH-500 (WZ)		1/1



5601PGHM

Plenum with multiple connections to the air distribution terminals in the room

Code	Connection	Fan unit	Price €	Unit/Box
558 0444	8 x Ø75/90 mm	00GH-300 (WZ)		1/1
558 0445	12 x Ø75/90 mm	00GH-500 (WZ)		1/1



2138

Ball valve including 2-way servo motor - male/female connections.
Servo motor 230 V and 24 V

Code	Model	Type	Price €	Unit/Box
213 0020	2 ways	230 V - 50 Hz		1/14
213 0090	2 ways	24 V - 50 Hz		1/14



5601FGH

Replacement filter for ceiling dehumidifiers model 5600GH or 5600GHWZ

Code	Model	Fan unit	Price €	Unit/Box
558 0416	Coarse	00GH-300 (WZ)		1/1
558 0417	Coarse	00GH-500 (WZ)		1/1

DESCRIPTIONS

DESCRIPTION

Room dehumidification unit with low energy consumption for horizontal ceiling installation, ideal in combination with underfloor radiant systems, in GH isostatic version and in GHWZ version for integration to the cooling/thermal power to the air conditioning system.

PERFORMANCE

Equipped with cooling circuit for dehumidification alone or the integration of cooling/heating, made of brazed copper, finned water batteries, and equipped with high efficiency reciprocating compressor.

EC centrifugal fans with dual-suction brushless motors, very high efficiency, and low noise levels, in compliance with Erp regulations.

STRUCTURE

Self-supporting frame in painted sheet metal, closing by panels made of material with high thermal and acoustic insulation characteristics.

Coarse filters with easy access filtration class for periodic maintenance.

ADVANTAGES / STRENGTH

- Residential sector systems

CONTROLS

Electric panel on board unit with microprocessor and dedicated regulation, fan management, dirty filter management (timed), air recirculation and renewal management, possibility of unit control with different solutions.

External commands:

- Remote panel with integrated T-H probe;
- Mod Bus RTU RS 485 communication;
- digital inputs;
- can be combined with Climav 2.0 Building Management thermoregulation system.

Controls not included with the fan unit

PRODUCT RANGE



5600FH 5600FHWZ

Dehumidifiers in neutral/cold air, flow rates from 200 m³/h to 500 m³/h for vertical wall installation

Code	Model	Type	Price €	Unit/Box
558 0403	00FH-200	Neutral air		1/1
558 0404	00FH-300	Neutral air		1/1
558 0405	00FH-500	Neutral air		1/1
558 0406	00FH-300-WZ	Cold air		1/1
558 0407	00FH-500-WZ	Cold air		1/1

CONTROLS



9683CU

Code	Colour	Price €	Unit/Box
957 0213	Wi-Fi Black		1/1
957 0212	Wi-Fi White		1/1

PRINCIPLE OF OPERATION

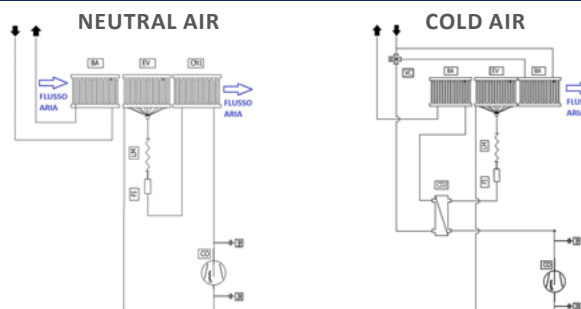

DIMENSIONAL AND TECHNICAL CHARACTERISTICS

DIMENSIONAL CHARACTERISTICS		Codes				
		558 0403	558 0404	558 0405	558 0406	558 0407
Water connections (supply - return)		1/2" - 1/2"				
Condensate connections	mm	16				
Weight	kg	36	44	48	44	48
FORMWORK						
Length	mm	915	1115	1315	1115	1315
Depth	mm	175	210	210	210	210
Height	mm	725	725	725	725	725
GRILLE						
Length	mm	972	1172	1372	1172	1372
Height	mm	754	754	754	754	754

TECHNICAL CHARACTERISTICS		558 0403	558 0404	558 0405	558 0406	558 0407
Type of fans		BLDC tangential with brushless motor				
Air flow rate	m ³ /h	220	320	500	320	500
Useful pressure	Pa	8	10	10	10	10
Useful dehumidifying capacity ¹	l/24h	12,2	16,5	29,8	16,5	29,8
Cooling capacity battery only ²	W	460	710	1060	710	1060
Air conditioning cooling capacity ²	W	1190	1850	2750	1850	2750
Thermal yield ³	W	540	810	1200	810	1200
Water flow rate	l/h	140	190	350	190	350
Pressure drop	Kpa	11	14	22	14	22
Filtration class		Coarse				
Compressor Type		Rotary	Alternative			
Refrigerant gas		R134A				
Sound pressure Lp	dB(A)	36	38	40	38	40
Supply voltage		230 V / 1 / 50 Hz				
Maximum current absorbed	A	1,76	3,35	4,51	3,35	4,51
Power consumption	W	360	570	850	570	850
Degree of protection		IP20				

¹ Ambient temperature 26°C; relative humidity 65%, Nominal air flow; Water in 16°C;

² Ambient temperature 26°C; relative humidity 65%, Nominal air flow; Water in 16°C;

³ Ambient temperature 20°C; relative humidity 60%, Nominal air flow; Water in 35°C;

Acoustic data related to UNI EN 3741 and UNI EN 3744



ACCESSORIES

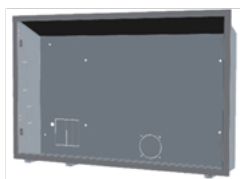

5601A
Galvanized sheet formwork for wall built-in installation

Code	Dimensions	Fan unit	Price €	Unit/Box
558 0410	915 x 750 x 175 mm	00FH-200		1/1
558 0411	1115 x 750 x 175 mm	00FH-300 (WZ)		1/1
558 0412	1315 x 750 x 175 mm	00FH-500 (WZ)		1/1



5601P
Front closing cover in white lacquered steel with RAL 9003 finish complete with delivery grille and air intake for wall built-in installation

Code	Dimensions	Fan unit	Price €	Unit/Box
558 0413	972 x 754 x 9 mm	00FH-200		1/1
558 0414	1172 x 754 x 9 mm	00FH-300 (WZ)		1/1
558 0415	1372 x 754 x 9 mm	00FH-500 (WZ)		1/1



2138
Ball valve including 2-way servo motor - male/female connections.
Servo motor 230 V and 24 V

Code	Model	Type	Price €	Unit/Box
213 0020	2 ways	230 V - 50 Hz		1/14
213 0090	2 ways	24 V - 50 Hz		1/14



5601FFH
Replacement filter for dehumidifiers wall installation model 5600FH or 5600FHWZ

Code	Model	Fan unit	Price €	Unit/Box
558 0418	Coarse	00FH-200		1/1
558 0419	Coarse	00FH-300 (WZ)		1/1
558 0420	Coarse	00FH-500 (WZ)		1/1

DESCRIPTIONS

DESCRIPTION

Room dehumidification unit with low energy consumption for wall built-in installation, ideal in combination with underfloor radiant systems, in isostatic FH version and in FHWZ version for integration to the cooling/thermal power to the air conditioning system.

PERFORMANCE

Equipped with cooling circuit for dehumidification alone or the integration of cooling/heating, made of brazed copper, finned water batteries, and equipped with high efficiency rotary or alternative compressor.

Brushless BLDC tangential fans with low consumption and very high efficiency, in compliance with the Erp standard.

STRUCTURE

Self-supporting frame in galvanized sheet, internally insulated with material with high thermal and acoustic insulation characteristics.

Coarse filters with easy access filtration class for periodic maintenance.

ADVANTAGES / STRENGTH

- Residential sector systems
- The unit can operate both in dehumidification mode and in summer/winter air conditioning

CONTROLS

Electric panel on board unit with microprocessor and dedicated regulation, fan management, dirty filter management (timed), air recirculation and renewal management, possibility of unit control with different solutions.

External commands:

- Remote panel with integrated T-H probe;
- Mod Bus RTU RS 485 communication;
- digital inputs;
- can be combined with Climav 2.0 Building Management thermoregulation system.

Controls not included with the fan unit

PRODUCT RANGE

NEW



5600FH1 5600FHWZ1

Dehumidifiers in neutral/cold air, capacity up to 500 m³/h for vertical wall built-in installation, with high efficiency motor

Code	Model	Type	Price €	Unit/Box
558 0446	00FH-350	Neutral air		1/1
558 0555	00FH-350-WZ	Cold air		1/1

CONTROLS



9683CU

Code	Colour	Price €	Unit/Box
957 0213	Wi-Fi <input checked="" type="checkbox"/> Black		1/1
957 0212	Wi-Fi <input type="checkbox"/> White		1/1

PRINCIPLE OF OPERATION

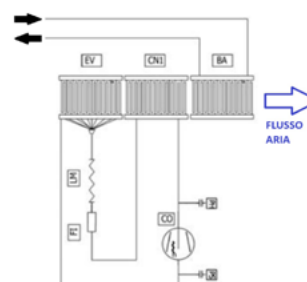

DIMENSIONAL AND TECHNICAL CHARACTERISTICS

DIMENSIONAL CHARACTERISTICS		Codes	
		558 0446	558 0555
Water connections (supply - return)		1/2" - 1/2"	1/2" - 1/2"
Condensate connections	mm	16	16
Weight	kg	31	-
FORMWORK			
Length	mm	761	761
Depth	mm	208	208
Height	mm	621	621
GRILLE			
Length	mm	790	790
Depth	mm	630	630
Height	mm	28	28
TECHNICAL CHARACTERISTICS		558 0446	558 0555
Type of fans		BLDC tangential with brushless motor	
Air flow rate massima	m ³ /h	500	500
Nominal air flow	m ³ /h	320	320
Useful pressure	Pa	50	50
Useful dehumidifying capacity ¹	l/24h	18	18
Cooling capacity battery only ²	W	-	1350
Air conditioning cooling capacity ²	W	1250	1250
Thermal yield ³	W	1100	1100
Water flow rate	l/h	220	220
Pressure drop	Kpa	5,2	5,2
Filtration class		Coarse	
Compressor Type		Rotary	
Refrigerant gas		R134A	
Sound pressure Lp	dB(A)	35	35
Supply voltage		230 V / 1 / 50 Hz	
Maximum current absorbed	A	4,2	4,2
Power consumption	W	-	-
Degree of protection		IP20	

¹ Ambient temperature 26°C; relative humidity 65%, Nominal air flow senza Supply acqua;

² Ambient temperature 26°C; relative humidity 65%, Nominal air flow; Water in 7/12°C;

³ Ambient temperature 20°C; relative humidity 60%, Nominal air flow; Water in 45/40°C;

Acoustic data related to UNI EN 3741 and UNI EN 3744



ACCESSORIES

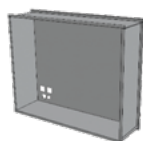

5601A1

Galvanized sheet formwork for wall built-in installation

Code	Dimensions	Fan unit	Price €	Unit/Box
558 0550	761 x 621 x 208 mm	00FH-350 (WZ)		1/1



5601P1

Front closing cover in white lacquered steel with RAL 9003 finish complete with delivery grille and air intake for wall built-in installation

Code	Dimensions	Fan unit	Price €	Unit/Box
558 0551	790 x 630 x 28 mm	00FH-350 (WZ)		1/1



2138

Ball valve including 2-way servo motor - male/female connections.
Servo motor 230 V and 24 V

Code	Model	Type	Price €	Unit/Box
213 0020	2 ways	230 V - 50 Hz		1/14
213 0090	2 ways	24 V - 50 Hz		1/14



5601FFH

Replacement filter for wall installation dehumidifiers model 5600FH1 or 5600FHWZ1

Code	Model	Fan unit	Price €	Unit/Box
558 0552	Coarse	00FH-350 (WZ)		1/1

DESCRIPTIONS

DESCRIPTION

Air conditioning unit designed for specific dehumidification/air conditioning needs in low energy consumption environments. The unit is particularly suitable where there is a radiant air conditioning system, single family units such as apartments, offices, or places where an effective dehumidification is needed such as underground rooms, bathrooms, laundries, swimming pools and spa areas. Unit in FHWZ version for integration to the cooling/thermal power to the air conditioning system.

PERFORMANCE

Equipped with high efficiency reciprocating compressor and cooling circuit for dehumidification alone or the integration of cooling/heating, made of brazed copper, finned water batteries, and equipped with high efficiency reciprocating compressor.

EC centrifugal fans with brushless motor with low consumption and very high efficiency, in compliance with the Erp standard.

STRUCTURE

Self-bearing frame in painted sheet metal, internally insulated with material with high thermal and acoustic insulation characteristics.

Coarse filters with easy access filtration class for periodic maintenance.

ADVANTAGES / STRENGTH

- Residential sector systems.
- The unit can operate both in dehumidification mode and in summer/winter air conditioning.

CONTROLS

Electric panel on board unit with microprocessor and dedicated regulation. Fan management, timed dirty filter management, recirculation air management. Possibility to control the unit with these three solutions:

- Management through remote panel with integrated T/H sensor;
- management through external controls and digital inputs;
- can be combined with Climav 2.0 Building Management thermoregulation system.

Controls not included with the fan unit

PRODUCT RANGE



5600FHDWZ

Dehumidifiers in cold air, 300 m³/h and 500 m³/h fl^w rate, vertical wall design installation

Code	Model	Type	Price €	Unit/Box
558 0408	00FHD-300-WZ	Cold air		1/1
558 0409	00FHD-500-WZ	Cold air		1/1

CONTROLS



9683CU

Code	Colour	Price €	Unit/Box
957 0213	Wi-Fi Black		1/1
957 0212	Wi-Fi White		1/1

PRINCIPLE OF OPERATION

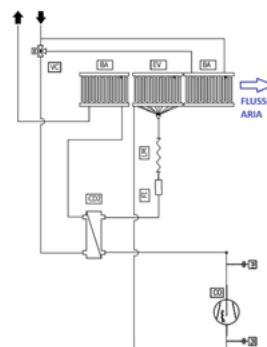

DIMENSIONAL AND TECHNICAL CHARACTERISTICS

DIMENSIONAL CHARACTERISTICS	Codes	
	558 0408	558 0409
Water connections (supply - return)	1/2" - 1/2"	
Condensate connections	mm	16
Weight	kg	36
FORMWORK		
Length	mm	915
Depth	mm	175
Height	mm	725
GRILLE		
Length	mm	972
Height	mm	754
TECHNICAL CHARACTERISTICS	558 0408	558 0409
Type of fans	BLDC tangential with brushless motor	
Air flow rate	m ³ /h	220
Useful pressure	Pa	8
Useful dehumidifying capacity ¹	l/24h	12,2
Cooling capacity battery only ²	W	460
Air conditioning cooling capacity ²	W	1190
Thermal yield ³	W	540
Water flow rate	l/h	140
Pressure drop	Kpa	11
Filtration class	Coarse	
Compressor Type	Rotary	Alternative
Refrigerant gas	R134A	
Sound pressure Lp	dB(A)	36
Supply voltage	230 V / 1 / 50 Hz	
Maximum current absorbed	A	1,76
Power consumption	W	360
Degree of protection	IP20	

¹ Ambient temperature 26°C; relative humidity 65%, Nominal air flow; Water in 16°C;

² Ambient temperature 26°C; relative humidity 65%, Nominal air flow; Water in 16°C;

³ Ambient temperature 20°C; relative humidity 60%, Nominal air flow; Water in 35°C; Acoustic data related to UNI EN 3741 and UNI EN 3744



ACCESSORIES



5601FFH

Replacement filter for dehumidifiers wall installation model 5600FHDWZ



2138

Ball valve including 2-way servo motor - male/female connections.

Servo motor 230 V and 24 V

Code	Model	Fan unit	Price €	Unit/Box
558 0419	Coarse	00FHD-300-WZ		1/1
558 0420	Coarse	00FHD-500-WZ		1/1

Code	Model	Type	Price €	Unit/Box
213 0020	2 ways	230 V - 50 Hz		1/14
213 0090	2 ways	24 V - 50 Hz		1/14

DESCRIPTIONS

DESCRIPTION

Room dehumidification unit with low energy consumption for external wall installation with cabinet, ideal in combination with radiant floor systems, in version with integration to the cooling/thermal power to the air conditioning system.

Design finish, with clean and simple lines, which makes the appliance adaptable to any residential context.

PERFORMANCE

Equipped with cooling circuit for dehumidification alone or the integration of cooling/heating, made of brazed copper, finned water batteries, and equipped with high efficiency rotary or alternative compressor.

Brushless BLDC tangential fans with low consumption and very high efficiency, in compliance with the Erp standard.

STRUCTURE

Self-supporting frame in galvanized sheet, internally insulated with material with high thermal and acoustic insulation characteristics.

Flat filters a bassa Pressure drop, di facile accessibilità per la manutenzione periodica.

ADVANTAGES / STRENGTH

- Residential sector systems.
- The unit can operate both in dehumidification mode and in summer/winter air conditioning.

CONTROLS

Electric panel on board unit with microprocessor and dedicated regulation, fan management, dirty filter management (timed), air recirculation and renewal management, possibility of unit control with different solutions.

External commands:

- Remote panel with integrated T-H probe;
- Mod Bus RTU RS 485 communication;
- digital inputs;
- can be combined with Climav 2.0 Building Management thermoregulation system.

Controls not included with the fan unit

The quality of the air we breathe is often compromised by polluting factors that in addition to making it unpleasant to smell more and more often also make it harmful to our health. Exchanging air in a traditional way, opening the windows, causes a significant heat loss both in winter and summer and consequently a greater economic expenditure.

In recent years, new regulations focused on energy saving have imposed the obligation to install higher quality windows with minimal air infiltration. But while dispersions are contained, inadequate air exchange can lead to problems such as surface condensation. A high concentration of humidity, has as a direct consequence the onset of unpleasant odours, the degradation of the interior fittings and the formation of mould that could lead to the onset of allergic pathologies. The most effective remedy is certainly controlled mechanical ventilation.

Through the extraction of stale air and the introduction of fresh and clean air from the outside, it is possible to eliminate all pollutants and moisture formation.

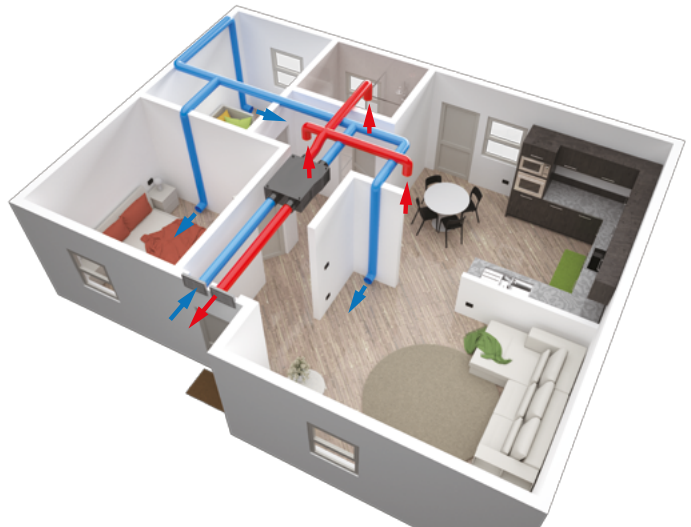

The system is developed in an absolutely non-invasive way leaving only the terminal elements visible, it also has a simple operation with minimal operating and maintenance costs. The presence of a heat recovery unit with very high efficiency also allows to improve the energy class of the property, guaranteeing its value over time. Tiemme has developed a complete range of controlled mechanical ventilation units, available in various dimensions to meet volumetric needs, comfort, and desired price. Tiemme offers compact solutions that can be installed on ducted ceilings, solutions with ductable vertical machines for installation in technical premises with the great advantage of facilitating the maintenance and cleaning of filters and point solutions that require minimal wall interventions and do not require ducting. The point units, also called decentralized, for horizontal wall installation, are the ideal solution in buildings with low energy requirements and for redevelopment work where installation work is to be reduced to a minimum.

DECENTRALIZED CMV - RESIDENTIAL

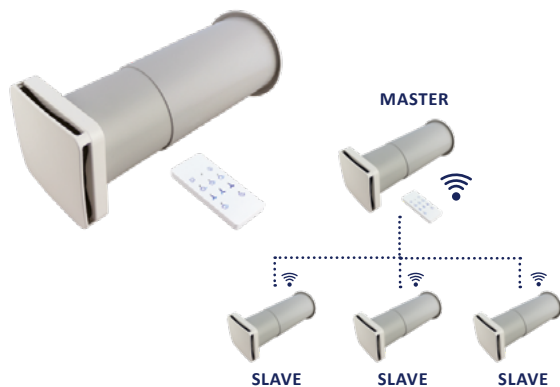

CMV CEILING INSTALLATION - RESIDENTIAL



DECENTRALIZED CMV - TERTIARY/EDUCATION

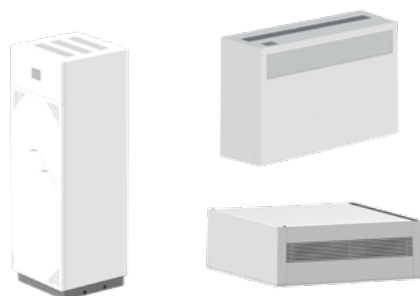

CMV WALL INSTALLATION - TERTIARY

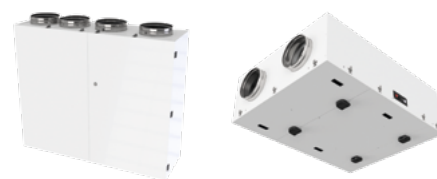

PRODUCT RANGE



5506

Decentralized CMV ventilation unit with high efficiency heat recovery (up to > 90%) for horizontal installation through the wall

Code	Model	Flow rat	Type	Price €	Unit/Box
558 0388	EOLO 01-M	8 m ³ /h a 25 m ³ /h	Master		1/1
558 0390	EOLO 01-S	8 m ³ /h a 25 m ³ /h	Slave		1/1
558 0389	EOLO 02-M	15 m ³ /h a 50 m ³ /h	Master		1/1
558 0391	EOLO 02-S	15 m ³ /h a 50 m ³ /h	Slave		1/1

COMPONENTS

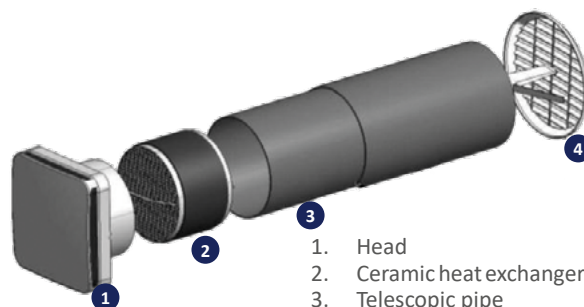

1. Head
2. Ceramic heat exchanger
3. Telescopic pipe
4. External grille

PRINCIPLE OF OPERATION

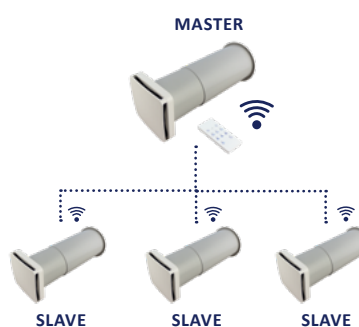

Combinations:

N°1 Master
N°15 Slave (max.)

Connecting with wireless network.

Maximum distance between Master and Slave up over 10 meters.

DIMENSIONAL CHARACTERISTICS

		Codes	
		558 0388	558 0389
		558 0390	558 0391
Depth [W]	mm	280/450	280/540
Length [L]	mm	180	180
Height [H]	mm	180	180
Diameter [DN]	mm	100	160
Weight	kg	2,7	4

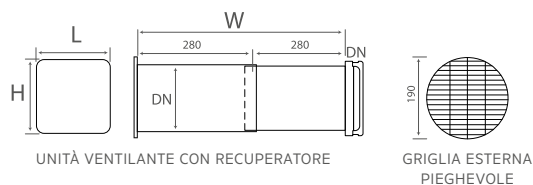

TECHNICAL CHARACTERISTICS

		EOLO 01 Master/Slave 558 0388 558 0390	EOLO 02 Master/Slave 558 0389 558 0391
Speed	Nr	3	3
Nominal air flow	m ³ /h	24	50
Air flow in the cycle	m ³ /h	18	38
Air flow rate max/med/min speed	m ³ /h	24/12/8	50/25/15
Air flow max/med/min cycle speed	m ³ /h	18/9/6	38/20/12
Night air flow rate	m ³ /h	5	10
Type of exchanger		Axial DC Brushless	
Recovery efficiency	%	79	77
Type of filters		Flat filters	
Filtration class		G3	
Max/med/min Lw sound power	dBA	39/37/34	44/38/29
Sound pressure at 1 mt max/med/min	dBA	28/26/23	32/26/18
Voltage/Frequency	V/Ph/Hz	230/1/50	
Absorption	A	0,21	0,25
Power consumption	W	2	2,8
Degree of protection		IPX4	

PRODUCT RANGE

NEW



5506XL

Decentralized CMV ventilation unit for large flow rates, high-performance heat recovery, horizontal ceiling installations, vertical wall installations and floor cabinets

Code	Model	Type	Price €	Unit/Box
558 0447	ATMOS 60 H	Horizontal		1/1
558 0448	ATMOS 120 H	Horizontal		1/1
558 0449	ATMOS 60 V	Vertical		1/1
558 0450	ATMOS 120 V	Vertical		1/1
558 0451	ATMOS 70 A	Closet		1/1

CONTROLS



5508COM

Code	Colour	Price €	Unit/Box
957 0218	Wi-Fi <input checked="" type="checkbox"/> Black		1/1
957 0217	Wi-Fi <input type="checkbox"/> White		1/1

PRINCIPLE OF OPERATION

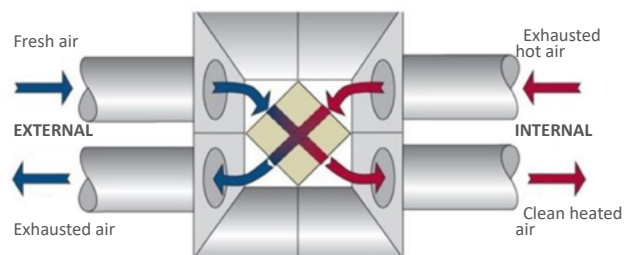

DIMENSIONAL AND TECHNICAL CHARACTERISTICS

DIMENSIONAL CHARACTERISTICS		Codes				
		558 0447	558 0448	558 0449	558 0450	558 0451
Length	mm	1040	1433	1040	1433	605
Depth	mm	905	904	405	403	640
Height	mm	405	403	905 (+50)	904 (+50)	1812 (+50)
External air	∅ mm	250	250	250	250	250
Air ejection	∅ mm	250	250	250	250	250
Condensation drain	∅ mm	20	20	20	20	20
Weight	kg	71	88	72	89	86

TECHNICAL CHARACTERISTICS		558 0447	558 0448	558 0449	558 0450	558 0451
Ventilation air flow rate (V2 / V2 / V1)	m³/h	620/355/165	1150/750/255	620/355/165	1150/750/255	700
Useful pressure	Pa	15	15	15	15	15
HEAT EXCHANGER ¹						
Type of exchanger and number		Polypropylene countercurrent plates - no.2				
Recovery efficiency EN13141-7	%	86,1	84,9	86,1	84,9	85,9
Recovery efficiency EN305	%	91,8	90,4	91,8	90,4	91,3
FILTERS						
Type of filters		Pleated filters				
Filtration class	%	70 (ePM1)				
Lw sound power transmitted by the structure	dB(A)	59	62	59	62	60
Average sound pressure Lp at 3 metres (V1)	dB(A)	41	43	41	43	41
Average sound pressure Lp at 3 metres (V2)	dB(A)	36	37	36	37	35
Average sound pressure Lp at 3 metres (V3)	dB(A)	33	34	33	34	32
ELECTRICAL DATA						
Supply voltage		230 V / 1 / 50 Hz				
Absorbed current	A	3,5	4,8	3,5	4,8	3,6
Maximum power consumption	W	340	620	340	620	360
Power consumption (V3) ²	W	165	355	165	355	330
Degree of protection		IPX0				

¹ External air temperature 7°; relative humidity 72%. Ambient temperature 25°C; relative humidity 50%, Nominal air flow

² Measured with pressure 15 Pa and clean filters.

Acoustic data related to UNI EN 3741 and UNI EN 3744



PRICE LIST

ACCESSORIES

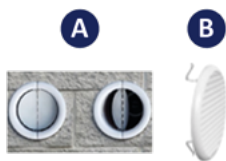

5506XLGR
External air intake/ ejection grilles for CMV decentralized ATMOS models



5506XLFIL
Replacement filter kit for decentralized CMV units ATMOS models filtration class F7 ePM1 70%

Code	Conn.	Fan unit	Type	Price €	Unit/Box
558 0452	Ø 200	ATMOS 60 (H/V) ATMOS 70 A	A		1/1
558 0453	Ø 250	ATMOS 120 (H/V)	B		1/1

Code	Model	Type	Price €	Unit/Box
558 0454	Flat	ATMOS 60 (H/V)		1/1
558 0455	Flat	ATMOS 120 (H/V)		1/1
558 0456	Flat	ATMOS 70 A		1/1

DESCRIPTIONS

DESCRIPTION

High efficiency decentralized heat recovery line, dedicated to the air renewal without energy waste.

Suitable for air treatment in individual environments where it is not possible to create ducted distributions, schools, offices, and commercial activities.

Available in three types of installation, horizontal (H), vertical sub-window (V) and vertical cabinet (A).

Five models with capacities from 165 m³/h to 1150 m³/h, recovery efficiencies over 90% (EN305) and contained sound pressure levels.

PERFORMANCE

Cross-flow counter-current high efficiency exchanger in polypropylene, summer and winter operation with high performance, equipped with by-pass for the intake of air renewal according to the ambient conditions.

EC centrifugal fans with high efficiency brushless motor.

Filters positioned upstream of the recuperator with ePM1 filtration class, easy removal and replacement without equipment.

Free cooling realized inside the unit with wide passage section and damper with motorized actuator.

STRUCTURE

Perimeter structure self-supporting galvanized sheet, the insulation of the panels is made with high performance polyethylene insulation.

ADVANTAGES / STRENGTH

- Tertiary facilities, schools, offices, or commercial units.
- Filter maintenance with simple panel removal and direct access without tools.

CONTROLS

Electric panel complete with 4-speed fan management, antifreeze, automatic by-pass, temperature probes, dirty filter signalling and post heating battery management.

Panel on board machine for all units and remote for horizontal ceiling units, necessary for operation with capacitive touch panel, integrated temperature, and humidity sensors.

Availability of remote controls both in Modbus version (on request) and in Wi-Fi version (Accessories).

Controls not included with the fan unit

PRODUCT RANGE



55040

Ventilation unit with high efficiency heat recovery unit for horizontal ceiling installation. Unit designed for horizontal or vertical installation

Code	Model	Price €	Unit/Box
558 0382	REC 150		1/1
558 0383	REC 200		1/1

CONTROLS



5508COM

Code	Colour	Price €	Unit/Box
957 0218	Wi-Fi <input checked="" type="checkbox"/> Black		1/1
957 0217	Wi-Fi <input type="checkbox"/> White		1/1

PRINCIPLE OF OPERATION

HORIZONTAL INSTALLATION

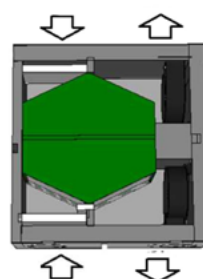

VERTICAL INSTALLATION

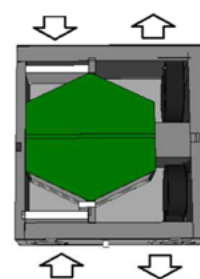

DIMENSIONAL AND TECHNICAL CHARACTERISTICS

DIMENSIONAL CHARACTERISTICS		Codes	
		558 0382	558 0383
Length	mm	580	
Depth	mm	580	
Height	mm	255	
Air connection diameters	∅ mm	160	
Condensation drain (Horizontal)	∅ mm	12	
Condensation drain (Vertical)	∅ mm	20	
Weight	kg	19	

TECHNICAL CHARACTERISTICS		558 0382	558 0383
Air flow rate	m ³ /h	130	190
Useful pressure	Pa	100	100
HEAT EXCHANGER			
Type of exchanger and number		polypropylene countercurrent plates - no.1	
Recovery efficiency	%	82,5	82
ACOUSTIC DATA			
Average sound pressure Lp at 1 meter	dB(A)	42,1	43,8
Average sound pressure Lp at 3 metres	dB(A)	34,7	36
ELECTRICAL DATA			
Supply voltage	V	230 / 1 / 50 Hz	
Absorbed current	A	0,8	1,2
Power consumption	W	95	130
Degree of protection		IPX0	

Data related to UNI EN 13141-7 Internal Temp. 20°C - Internal humidity 28% / External temp 7°C - External humidity 72%
Acoustic data related to UNI EN 3741 and UNI EN 3744



ACCESSORIES



5509EL

Electric post-heating battery with circular passage section, single-phase 230 V power supply

Code	Conn.	Power [W]	Price €	Unit/Box
558 0458	Ø 160	800		1/1
558 0459	Ø 160	1200		1/1
558 0460	Ø 160	1600		1/1
558 0461	Ø 160	2400		1/1



5509EF

Post-heating or cooling hydraulic battery, internally insulated and with circular passage section

Code	Conn.	Power ¹ [W]	Price €	Unit/Box
558 0473	Ø 125	2000		1/1
558 0474	Ø 160	3400		1/1

Electric batteries:
² Batteries heating:

¹ Insulated batteries heating/cooling:

Power output equivalent to electrical power, signal adjustment 0-10 V.
 Yields with water 90 °C/70 °C
 Water yields at +7 °C/+12 °C - Air +32 °C.



5504OFIL

Flat filter kit for heat recovery, filtration class F7 ePM1 70%

Code	Model	Fan unit	Price €	Unit/Box
558 0457	Flat filters	REC 150 - REC 200		1/1

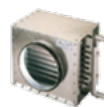

5509EC

Hydraulic post heating battery with circular passage section

Code	Conn.	Power ² [W]	Price €	Unit/Box
558 0478	Ø 125	2600		1/1
558 0479	Ø 160	3600		1/1

DESCRIPTIONS

DESCRIPTION

Dual flow residential ventilation unit with high efficiency heat recovery, available in 2 dimensions already configured for both horizontal and vertical installations. Suitable to meet the values and energy standards required in new buildings and redevelopments.

Enthalpic version available on request

PERFORMANCE

Exchanger in polypropylene with cross-flow counter-current with high efficiency, low freezing temperatures and very high exchange efficiency.

Brushless fans with electronic motor, constant flow control, very high efficiency, and low noise levels.

Filters ePM1 70% with low pressure drop.

Free cooling with automatic management through temperature probes.

STRUCTURE

Self-supporting frame in sheet metal, galvanized sheet panels, externally painted with high density Eps internal insulation and front aesthetic in composite Aluicobond.

Filters easily removable both in horizontal and vertical position.

ADVANTAGES / STRENGTH

- Easy configuration of the connections, makes the units easily adaptable to different plant requirements.
- Residential sector systems.
- Unit configured for ceiling or wall installation.

CONTROLS

Electric panel with 4 speed fan management board. Antifreeze functions, automatic by-pass, temperature probes, post-heating battery management and automatic dirty filter signalling.

Control panel mandatory for unit operation.

Can be combined with Climav 2.0 Building Management thermoregulation system.

Controls not included with the fan unit

PRODUCT RANGE



550401

Ventilation unit with high efficiency heat recovery unit for horizontal ceiling installation

Code	Model	Price €	Unit/Box
558 0384	REC 300		1/1
558 0385	REC 500		1/1

CONTROLS



5508COM

Code	Colour	Price €	Unit/Box
957 0218	Wi-Fi Black		1/1
957 0217	Wi-Fi White		1/1

PRINCIPLE OF OPERATION

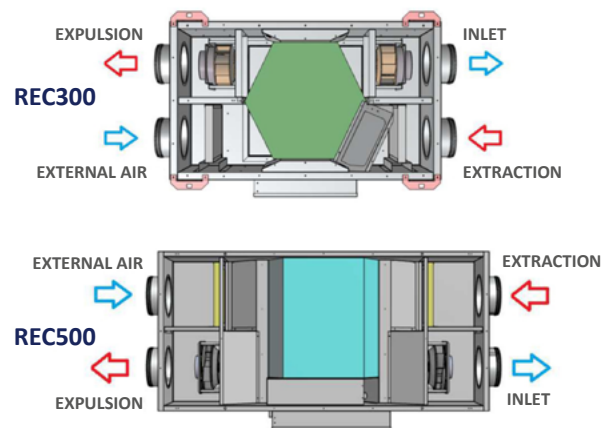

DIMENSIONAL AND TECHNICAL CHARACTERISTICS

DIMENSIONAL CHARACTERISTICS		Codes	
		558 0384	558 0385
Length	mm	795	1150
Depth	mm	600	650
Height	mm	295	290
Air connection diameters	Ø mm	160	
Condensation drain	Ø mm	12	
Weight	kg	30	39

TECHNICAL CHARACTERISTICS		558 0384	558 0385
Air flow rate	m³/h	295	450
Useful pressure	Pa	100	100
HEAT EXCHANGER			
Type of exchanger and number		polypropylene countercurrent plates - no.1	
Recovery efficiency	%	82	85,6
ACOUSTIC DATA			
Average sound pressure Lp at 1 meter	dB(A)	48,9	55,3
Average sound pressure Lp at 3 metres	dB(A)	41,5	47,6
ELECTRICAL DATA			
Supply voltage	V	230 / 1 / 50 Hz	
Absorbed current	A	1,6	2,5
Power consumption	W	340	
Degree of protection		IP44	

Data related to UNI EN 13141-7 Internal Temp. 20°C - Internal humidity 28% / External temp 7°C – External humidity 72%
Acoustic data related to UNI EN 3741 and UNI EN 3744



ACCESSORIES



5509EL

Electric post-heating battery with circular passage section, single-phase 230 V power supply

Code	Conn.	Power [W]	Price €	Unit/Box
558 0458	Ø 160	800		1/1
558 0459	Ø 160	1200		1/1
558 0460	Ø 160	1600		1/1
558 0461	Ø 160	2400		1/1



5509EF

Post-heating or cooling hydraulic battery, internally insulated and with circular passage section

Code	Conn.	Power ¹ [W]	Price €	Unit/Box
558 0473	Ø 125	2000		1/1
558 0474	Ø 160	3400		1/1

Electric batteries:

¹ Insulated batteries heating/cooling:

² Batteries heating:

Power output equivalent to electrical power, signal adjustment 0-10 V.

Water yields at +7 °C/+12 °C - Air +32 °C.

Yields with water 90 °C/70 °C



5504FIL

Flat filter kit for heat recovery, filtration class F7 ePM1 70%

Code	Model	Fan unit	Price €	Unit/Box
558 0486	Flat	REC 300 / REC 30V		1/1
558 0487	Flat	REC 500		1/1



5509EC

Hydraulic post heating battery with circular passage section

Code	Conn.	Power ² [W]	Price €	Unit/Box
558 0478	Ø 125	2600		1/1
558 0479	Ø 160	3600		1/1

DESCRIPTIONS

DESCRIPTION

Dual flow residential ventilation unit with high efficiency heat recovery, available in 2 dimensions for ceiling installation.

Suitable to meet the values and energy standards required in new buildings and redevelopments.

Available in enthalpic version on request.

PERFORMANCE

Exchanger in polypropylene with cross-flow counter-current with high efficiency, low freezing temperatures and very high exchange efficiency.

Brushless fans with electronic motor, constant flow control, very high efficiency, and low noise levels.

Filters ePM1 70% with low pressure drop.

Free cooling realized inside the unit with wide air passage and damper.

Recovery efficiency greater than 90%.

STRUCTURE

Self-supporting frame in sheet metal, galvanized sheet panels, externally painted with high density Eps internal insulation and front aesthetic in composite Aluicobond.

Filters easily removable both in horizontal and vertical position.

ADVANTAGES / STRENGTH

- Easy configuration of the connections, makes the units easily adaptable to different plant requirements.
- Residential sector systems.
- Unit configured for ceiling or wall installation.

CONTROLS

Electric panel with 4 speed fan management board.

Antifreeze functions, automatic by-pass, temperature probes, post-heating battery management and automatic dirty filter signalling.

Control panel mandatory for unit operation.

Can be combined with Climav 2.0 Building Management thermoregulation system.

Controls not included with the fan unit

PRODUCT RANGE



5507

Ventilation unit for wall built-in mounting, complete with high efficiency heat recovery unit. Combined with built-in frame complete with distribution plate and front panel closure

Code	Model	Price €	Unit/Box
558 0392	RECI 150		1/1
558 0393	RECI 220		1/1

CONTROLS



5507COM

Code	Colour	Price €	Unit/Box
957 0219	LCD <input type="checkbox"/> White		1/1

PRINCIPLE OF OPERATION



1. Air of renewal
2. Intake air
3. Local extraction
4. Expulsion

DIMENSIONAL AND TECHNICAL CHARACTERISTICS

DIMENSIONAL CHARACTERISTICS		Codes	
		558 0392	558 0393
Length	mm	1000	1000
Depth	mm	520	600
Height	mm	207	267
Air connection diameters	∅ mm	125	160
External file connection diameters	∅ mm	127	157
Connections centre distance	mm	270	286
Upper wire connection distance	mm	104	134
Front distance condensate drain	mm	778	628
Condensate drain top wire distance	mm	84	84
Weight	kg	37	47

TECHNICAL CHARACTERISTICS		558 0392	558 0393
Type of fans		No. 2 Bladed centrifuges Forward Motor Brushless Electronic directly coupled	
Air flow rate [nominal]	m ³ /h	119	187
Useful pressure	Pa	50	50
Type of exchanger and number		polypropylene countercurrent plates - no.1	
Recovery efficiency	%	85,3	83,9
Antifreeze protection		Integrated	
Type of filters		Flat filters	
Filtration class		ePM1 70%	
Sound power Lwa	dB(A)	52	51
Average sound pressure Lp at 1.5 metres	dB(A)	41	39
Supply voltage	V	230 / 1 / 50 Hz	
Absorbed current	A	0,8	1,5
Power consumption	W	100	173
Degree of protection		IP44	

Data related to UNI EN 13141-7 Internal Temp. 20°C - Internal humidity 28% / External temp 7°C - External humidity 72%
Acoustic data related to UNI EN 3741 and UNI EN 3744



PRICE LIST

ACCESSORIES



5507T

Built-in frame for ventilation units with high efficiency heat recovery for built-in vertical installation

Code	Dimensions	Price €	Unit/Box
558 0394	682 x 1525 x 225 mm		1/1
558 0395	762 x 1525 x 275 mm		1/1



5507COP

Built-in frame cover for ventilation unit with high efficiency heat recovery unit for built-in vertical installation

Code	Finishing	Price €	Unit/Box
558 0396	<input type="checkbox"/> White		1/1
558 0397	<input type="checkbox"/> White		1/1



5507FIL

Replacement filter kit for wall mounted fan units Filtration class F7 ePM1 70%. (Complete replacement 2 filters)

Code	Model	Fan unit	Price €	Unit/Box
558 0483	Flat filters	RECI 150		1/1
558 0484	Flat filters	RECI 220		1/1

DESCRIPTIONS

DESCRIPTION

Residential ventilation built-in unit, double flow with high efficiency heat recovery, available in 2 dimensions in combination with built-in frame and front closure panel. Suitable to meet the values and energy standards required in new buildings and redevelopments.

PERFORMANCE

Exchanger in polypropylene with cross-flow counter-current with high efficiency, low freezing temperatures and very high exchange efficiency.
EC fans with electronic motor, constant flow rate control, very high efficiency, and low noise levels.
Filters ePM1 70% with low pressure drop.
Free cooling with automatic management through temperature probes.

STRUCTURE

Self-supporting frame and cover panels in pre-painted sheet metal, internal insulation in rock wool thickness 22 mm. Easily removable filters for maintenance.
Galvanized steel formwork with thermal/acoustic insulation in polyethylene 10 mm thickness. Removable front panel in sheet metal.

ADVANTAGES / STRENGTH

- Residential sector systems.
- Optimization of the built-in thickness.

CONTROLS

Electric panel with 4 speed fan management board. Antifreeze functions, automatic by-pass, temperature probes, post-heating battery management and automatic dirty filter signalling.

Control panel mandatory for unit operation. Can be combined with Climav 2.0 Building Management thermoregulation system.

Controls not included with the fan unit

PRODUCT RANGE



5504V

Ventilation unit with high efficiency heat recovery unit for vertical wall or floor installation

Code	Model	Price €	Unit/Box
558 0442	REC 20V		1/1
558 0386	REC 30V		1/1
558 0443	REC 40V		1/1
558 0387	REC 50V		1/1

CONTROLS



5508COM

Code	Colour	Price €	Unit/Box
957 0218	Wi-Fi Black		1/1
957 0217	Wi-Fi White		1/1

PRINCIPLE OF OPERATION

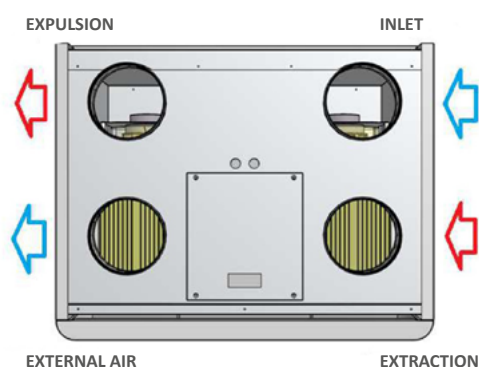

DIMENSIONAL AND TECHNICAL CHARACTERISTICS

DIMENSIONAL CHARACTERISTICS		Codes			
		558 0442	558 0386	558 0443	558 0387
Length	mm	630	790	790	790
Depth	mm	495	640	770	770
Height	mm	570	670	670	670
Air connection diameters	Ø mm	125	160	160	160
Condensation drain	Ø mm	20	20	20	20
Weight	kg	32	38	42	43

TECHNICAL CHARACTERISTICS		558 0442	558 0386	558 0443	558 0387
Air flow rate	m³/h	158	306	375	475
Useful pressure	Pa	100			
HEAT EXCHANGER					
Type of exchanger and number		polypropylene countercurrent plates - no.1			
Recovery efficiency	%	86,3	85	87	84
ACOUSTIC DATA					
Average sound pressure Lp at 1 meter	dB(A)	46,4	47,7	45,9	51,9
Average sound pressure Lp at 3 metres	dB(A)	38,6	41	38,4	44,4
ELECTRICAL DATA					
Supply voltage	V	230 / 1 / 50 Hz			
Absorbed current	A	0,8	1,6	1,6	2,5
Power consumption	W	96	170	170	350
Degree of protection		IP44			

Data related to UNI EN 13141-7 Internal Temp. 20°C - Internal humidity 28% / External temp 7°C - External humidity 72%
Acoustic data related to UNI EN 3741 and UNI EN 3744



ACCESSORIES



5509EL
Electric post-heating battery with section circular passage, single-phase 230 V supply

Code	Conn.	Power [W]	Price €	Unit/Box
558 0458	Ø 160	800		1/1
558 0459	Ø 160	1200		1/1
558 0460	Ø 160	1600		1/1
558 0461	Ø 160	2400		1/1



5509EF
Post-heating or cooling hydraulic battery, internally insulated and with circular passage section

Code	Conn.	Power ¹ [W]	Price €	Unit/Box
558 0473	Ø 125	2000		1/1
558 0474	Ø 160	3400		1/1

Electric batteries:
Power output equivalent to electrical power, signal adjustment 0-10 V

² Batteries heating:
Yields with water 90 °C/70 °C

¹ Insulated batteries heating/cooling:
Water yields at +7 °C/+12 °C - Air +32 °C.



5504FIL
Flat filter kit for heat recovery, filtration class F7 ePM1 70%

Code	Model	Fan unit	Price €	Unit/Box
558 0485	Flat	REC 20V		1/1
558 0486	Flat	REC 300 / REC 30V		1/1
558 0488	Flat	REC 40V - REC 50V		1/1

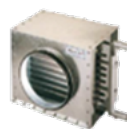

5509EC
Hydraulic post heating battery with circular passage section

Code	Model	Power ² [W]	Price €	Unit/Box
558 0478	Ø 125	2600		1/1
558 0479	Ø 160	3600		1/1



5504VP
4 support feet Kit for installation on the floor

Code	Model	Fan unit	Price €	Unit/Box
558 0489	REC V PAV	All		1/1

DESCRIPTIONS

DESCRIPTION

Dual flow residential ventilation unit with high efficiency heat recovery, available in 4 dimensions for wall or floor installation.

Suitable to meet the values and energy standards required in new buildings and redevelopments.
Available in enthalpic version on request.

PERFORMANCE

Exchanger in polypropylene with cross-flow counter-current with high efficiency, low freezing temperatures and very high exchange efficiency.
Brushless fans with electronic motor, constant flow control, very high efficiency, and low noise levels. Filters ePM1 70% with low pressure drop.
Free cooling with automatic management through temperature probes.

STRUCTURE

Self-supporting frame in sheet metal, galvanized sheet panels, externally painted with high density Eps internal insulation and front aesthetic in composite Aluicobond.
Filters easily removable both in horizontal and vertical position.

ADVANTAGES / STRENGTH

- Easy configuration of the connections, makes the units easily adaptable to different plant requirements.
- Residential sector systems.

CONTROLS

Electric panel with 4 speed fan management board.
Antifreeze functions, automatic by-pass, temperature probes, post-heating battery management and automatic dirty filter signalling.

Control panel mandatory for unit operation.

Controls not included with the fan unit

PRODUCT RANGE

NEW



55120

Ventilation unit for tertiary applications, with high efficiency heat recovery unit, horizontal ceiling, or floor installation

Code	Model	Price €	Unit/Box
558 0490	EVO TER 900		1/1
558 0491	EVO TER 1200		1/1

CONTROLS



5507COM

Code	Colour	Price €	Unit/Box
957 0219	LCD <input type="checkbox"/> White		1/1

PRINCIPLE OF OPERATION

CEILING

FLOOR

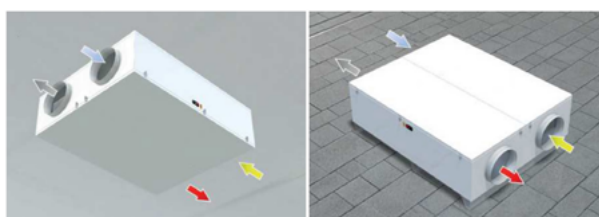

DIMENSIONAL AND TECHNICAL CHARACTERISTICS

DIMENSIONAL CHARACTERISTICS		Codes	
		558 0490	558 0491
Length	mm	1044	1234
Depth	mm	1416	1618
Height	mm	443	443
Air connection diameters	∅ mm	250	315
Condensation drain	∅ mm	20	20
Weight	kg	100	115

TECHNICAL CHARACTERISTICS		558 0490	558 0491
Air flow rate normale	m ³ /h	900	1200
Air flow rate massima	m ³ /h	990	1650
Useful pressure (maximum flow rate)	Pa	750	1480
HEAT EXCHANGER			
Type of exchanger and number		polypropylene countercurrent plates - no.1	
Recovery efficiency	%	80,1	79,9
FILTERS			
Type and class of filtration	Renewal	Flat - F7 ePM1 70%	
Type and class of filtration	Intake	Flat - M5 ePM10 50%	
ACOUSTIC DATA			
Sound pressure L _{wa}	dB(A)	59	64
Average sound pressure L _p at 1.5 metres ¹	dB(A)	47	52
ELECTRICAL DATA			
Supply voltage	V	230 / 1 / 50 Hz	
Absorbed current	A	2,9	4,6
Power consumption	W	380	1100
Degree of protection		IP44	

Operating conditions: Ambient temperature 0°C / 45°C - R.H. <80%
Renewal temperature -7°C/+40°C

¹ Date referred to correctly installed machine with nominal flow at a distance of 1.5 meters.



ACCESSORIES



5509EL

Electric post-heating battery with section circular passage, single-phase 230 V supply

Code	Conn.	Power [W]	Price €	Unit/Box
558 0466	Ø 250	600		1/1
558 0467	Ø 250	1500		1/1
558 0468	Ø 250	2000		1/1
558 0469	Ø 250	3000		1/1
558 0470	Ø 315	1500		1/1
558 0471	Ø 315	2000		1/1
558 0472	Ø 315	3000		1/1



5509EF

Post-heating or cooling hydraulic battery, internally insulated and with circular passage section

Code	Conn.	Power ¹ [W]	Price €	Unit/Box
558 0476	Ø 250	7320		1/1
558 0477	Ø 315	13230		1/1

Electric batteries:
Power output equivalent to electrical power, signal adjustment 0-10 V

² Batteries heating:
Yields with water 90 °C/70 °C

¹ Insulated batteries heating/cooling:
Water yields at +7 °C/+12 °C - Air +32 °C.



5512FIL

Flat filter kit for heat recovery, filtration class F7 and M5 ePM1 70%

Code	Model	Fan unit	Price €	Unit/Box
558 0494	Delivery filters F7	EVO TER 900 (1200)		1/1
558 0495	Intake filters M5	EVO TER 900 (1200)		1/1

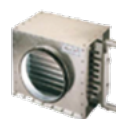

5509EC

Hydraulic post heating battery with circular passage section

Code	Model	Power ² [W]	Price €	Unit/Box
558 0481	Ø 250	7700		1/1
558 0482	Ø 315	12500		1/1



5513

Temperature and humidity probes and channel probe for tertiary type ventilating units, 0-10V control

Code	Type	Price €	Unit/Box
558 0492	TH probe from channel		1/1
558 0493	VOC probe from channel		1/1

DESCRIPTIONS

DESCRIPTION

Double flow controlled mechanical ventilation unit with high efficiency heat recovery, for the tertiary sector, available in 2 dimensions with horizontal configuration for ceiling or floor installation.

Suitable to meet the values and energy standards required in new buildings and redevelopments.

PERFORMANCE

Exchanger in polypropylene with cross-flow counter-current with high efficiency, low freezing temperatures and very high exchange efficiency.

EC centrifugal fan blades back with low consumption.

Integrated by-pass for free-cooling/free-heating (manual, motorized or automatic drives). Operating conditions Ambient temperature 0°C ÷ 45°C 80% humidity.

STRUCTURE

Self-supporting frame in pre-painted sheet metal, thermal and acoustic insulation in mineral wool.

F7 filters (ePM1 70%) with low pressure drop for renewal air; M5 filters (ePM10 50%) with low pressure drop for recovery air.

ADVANTAGES / STRENGTH

- Monoblock unit.
- Possibility of configuration of flows.
- Unit for indoor installation both ceiling and floor (with feet kit).

CONTROLS

LCD display control and regulation with integrated humidity and ambient temperature probes, for the complete management of the unit and any accessories.

External channel installation probes:

- TH probe from channel 0-10V;
- VOC probe from channel 0-10V.

Can be combined with Climav 2.0 Building Management thermoregulation system.

Controls not included with the fan unit

PRODUCT RANGE

NEW



5512V

Ventilation unit for tertiary applications, with high efficiency heat recovery unit, vertical wall installation or floor installation.

Code	Model	Price €	Unit/Box
558 0496	EVO TER 900 V		1/1
558 0497	EVO TER 1000 V		1/1
558 0498	EVO TER 1200 V		1/1

CONTROLS



5507COM

Code	Colour	Price €	Unit/Box
957 0219	LCD <input type="checkbox"/> White		1/1

PRINCIPLE OF OPERATION

INSPECTABLE SIDE FRONT VIEW

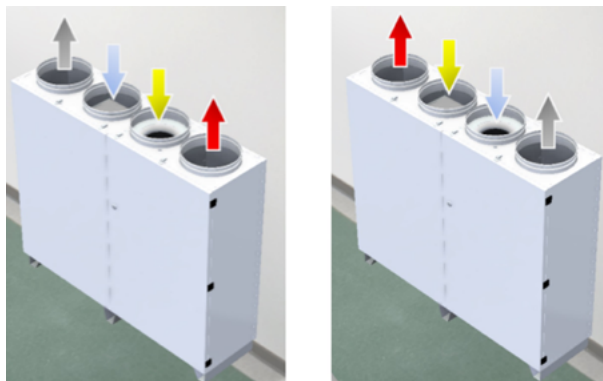

DIMENSIONAL AND TECHNICAL CHARACTERISTICS

DIMENSIONAL CHARACTERISTICS		Codes		
		558 0496	558 0497	558 0498
Length	mm	1350	1500	1500
Depth	mm	415	420	420
Height	mm	1104	1204	1204
Air connection diameters	∅ mm	250	315	315
Condensation drain	∅ mm	20	20	20
Weight	kg	95	108	110

TECHNICAL CHARACTERISTICS		558 0496	558 0497	558 0498
Air flow rate normale	m ³ /h	900	1200	1050
Air flow rate massima	m ³ /h	950	1210	1500
Useful pressure	Pa	55	20	597

HEAT EXCHANGER

Type of exchanger and number		polypropylene countercurrent plates - no.1		
Recovery efficiency	%	80,1	79,9	81,5

FILTERS

Type and class of filtration	Renewal	Flat - F7 ePM1 70%		
Type and class of filtration	Intake	Flat - M5 ePM10 50%		

ACOUSTIC DATA

Sound pressure L _{wa}	dB(A)	58	64	68
Average sound pressure L _p at 1.5 metres ¹	dB(A)	46	52	56

ELECTRICAL DATA

Supply voltage	V	230 / 1 / 50 Hz		
Absorbed current	A	2,9	3,0	4,6
Power consumption	W	380	470	1100
Degree of protection		IP44		

Operating conditions: Ambient temperature 0°C / 45°C - R.H. <80%
Renewal temperature -7°C/+40°C

1 Date referred to correctly installed machine with nominal flow at a distance of 1.5 meters.



ACCESSORIES



5509EL

Electric post-heating battery with section circular passage, single-phase 230 V supply

Code	Conn.	Power [W]	Price €	Unit/Box
558 0466	Ø 250	600		1/1
558 0467	Ø 250	1500		1/1
558 0468	Ø 250	2000		1/1
558 0469	Ø 250	3000		1/1
558 0470	Ø 315	1500		1/1
558 0471	Ø 315	2000		1/1
558 0472	Ø 315	3000		1/1



5509EF

Post-heating or cooling hydraulic battery, internally insulated and with circular passage section

Code	Conn.	Power ¹ [W]	Price €	Unit/Box
558 0476	Ø 250	7320		1/1
558 0477	Ø 315	13230		1/1

Electric batteries:
Power output equivalent to electrical power, signal adjustment 0-10 V

² Batteries heating:
Yields with water 90 °C/70 °C

¹ Insulated batteries heating/cooling:
Water yields at +7 °C/+12 °C - Air +32 °C.



5512VFIL

Flat filter kit for heat recovery, filtration class F7 and M5 ePM1 70%

Code	Model	Fan unit	Price €	Unit/Box
558 0553	Delivery filters F7	All		1/1
558 0554	Intake filters M5	All		1/1



5509EC

Hydraulic post heating battery with circular passage section

Code	Model	Power ² [W]	Price €	Unit/Box
558 0481	Ø 250	7700		1/1
558 0482	Ø 315	12500		1/1



5513

Temperature and humidity probes and channel probe for tertiary type ventilating units, 0-10V control

Code	Type	Price €	Unit/Box
558 0492	TH probe from channel		1/1
558 0493	VOC probe from channel		1/1

DESCRIPTIONS

DESCRIPTION

Double flow controlled mechanical ventilation unit with high efficiency heat recovery, for the tertiary sector, available in 3 dimensions with horizontal configuration for ceiling or floor installation. Suitable to meet the values and energy standards required in new buildings and redevelopments.

PERFORMANCE

Exchanger in polypropylene with cross-flow counter-current with high efficiency, low freezing temperatures and very high exchange efficiency.

EC centrifugal fan blades back with low consumption.

Integrated by-pass for free-cooling/free-heating (manual, motorized or automatic drives). Operating conditions Ambient temperature 0°C ÷ 45°C 80% humidity.

STRUCTURE

Self-supporting frame in pre-painted sheet metal, thermal and acoustic insulation in mineral wool.

F7 filters (ePM1 70%) with low pressure drop for renewal air; M5 filters (ePM10 50%) with low pressure drop for recovery air.

ADVANTAGES / STRENGTH

- Monoblock unit.
- Possibility of configuration of flows.
- Unit for installation (indoor) vertical wall or floor (with feet kit).

CONTROLS

LCD display control and regulation with integrated humidity and ambient temperature probes, for the complete management of the unit and any accessories.

External channel installation probes:

TH probe from channel 0-10V;

VOC probe from channel 0-10V.

Can be combined with Climav 2.0 Building Management thermoregulation system.

Controls not included with the fan unit

Dehumidifiers with air renewal are machines to be inserted typically in radiant systems to keep under control the relative humidity of the environment allowing, in parallel, the renewal of exhausted air through the use of high efficiency recuperators.

TIEMME offers two types of fan units, both with models for both ceiling and wall/floor installation;

DEU-VMC unit equipped with: **high efficiency heat recuperator, dehumidification and cooling section-heating;**

Hydronic DEU-VMC unit equipped with: high efficiency heat recuperator, dehumidification section, cooling- heating and additional hydronic battery.

DEU-VMC HORIZONTAL INSTALLATION UNIT



DEU-VMC VERTICAL INSTALLATION UNIT

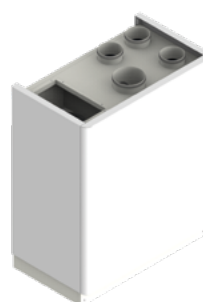

DEU-VMC units are controlled mechanical ventilation units with high efficiency heat recovery unit, air treatment section with dehumidification, cooling and heating. Particularly suitable for residential, commercial, or collective residential buildings, plug-and-play is provided for quick and easy installation.

The units are composed of a single unit including each component for proper operation and allow operation with wide external temperature ranges.

RECOVERY SECTION	High efficiency counter-current polypropylene heat exchanger >90%. Summer and winter operation.
VENTILATION	Brushless centrifugal fans with electronic motor and modulating control, very high efficiency, and low noise levels in compliance with the Erp standard. Regulation at constant flow.
AIR TREATMENT SECTION	The unit can be equipped with a cooling circuit for dehumidification or the integration of cooling and heating. In the various configurations, it will be possible to select the type of air treatment desired between only dehumidification or dehumidification with heating and cooling of primary air.
FILTRATION	Filters ePM1 70% easily removable on the external air intake on the extraction air. Coarse filters with low pressure drop easily removable on recirculation air.
STRUCTURE	Panels made of RAL9003 matt painted self-supporting sheet metal with high density EPS interior, self-supporting perimeter structure in galvanized sheet. The insulation of the panels is made with 20 and 30 mm thick high performance insulation.
REFRIGERATION CIRCUIT	Made of brazed copper complete with: high efficiency compressor, filter dehydrator, finned batteries, water exchanger, solenoid valves, rolling device, liquid receiver, high and low pressure pressure switches and pipe thermal insulation.
REGULATION	Electric panel on board unit with microprocessor and dedicated regulation. Fan management, display of internal machine temperature probes, time-controlled dirty filter management, recirculation and renewal air management. Possibility to control the unit: 1- Management through external controls and 0-10 Vdc signal for minimum to maximum air flow control; 2- Management through remote panel with integrated T/H sensor; 3- Modbus communication RTU RS 485



PRINCIPLES OF OPERATION

OPERATION VENTILATION ONLY

The unit will meet the mechanical ventilation with high efficiency heat recovery. It will be possible to select the fan speeds in order to obtain the desired flow rate to meet the demands of air renewal.

HORIZONTAL UNIT

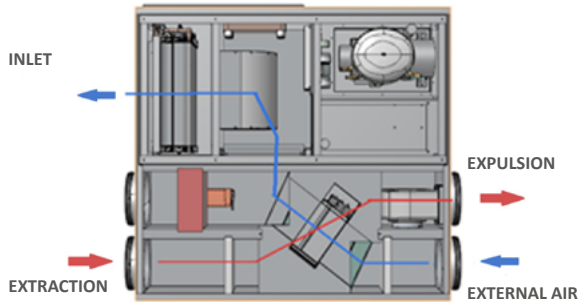

VERTICAL UNIT

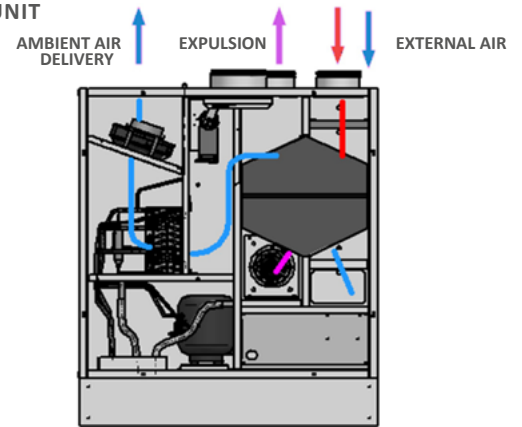

OPERATION VENTILATION, DEHUMIDIFICATION, AND INTEGRATION

The unit will continue to meet mechanical ventilation with high efficiency heat recovery but will increase the air flow rate, recirculating from a dedicated room air duct to increase the air volume on the integration part.

The integration part is from a version with dehumidification, integration, and integrative hydronic batteries.

The unit with hydronic integration finds its most common application in radiant systems where the need for dehumidification occurs and the integration of cooling in the summer. During operation, the unit, through humidity and temperature probes, activates the refrigeration circuit composed of the compressor, the evaporation battery air and the air/water condenser powered by the radiant system, thus achieving the dehumidification of air and the integration of cooling.

In winter it is however possible to use the unit to integrate the radiant heating through the supply of the hydronic hot water battery, obtaining a rapid thermal input to the environment.

HORIZONTAL UNIT

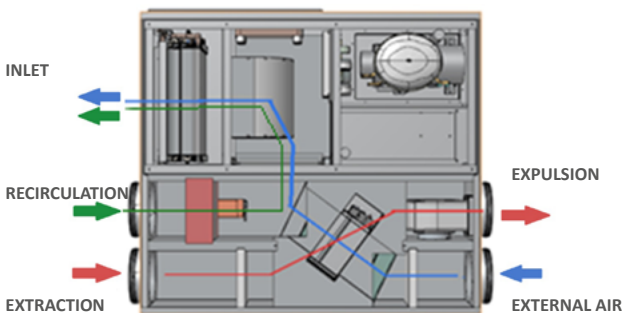

VERTICAL UNIT

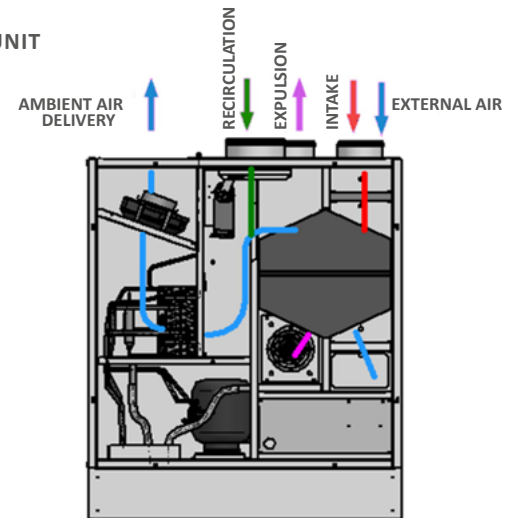

DEHUMIDIFICATION AND INTEGRATION IN COOLING/HEATING

Ventilating unit for the renewal of the ambient air with external air, through heat exchange through a high efficiency recuperator.

The renewal is increased by partially recirculating the ambient air, allowing at the same time to dehumidify the air and provide integration to the radiant air conditioning system for the cooling/ thermal power.

During the summer period (active compressor) the unit can operate in 2 modes:

- 1- Renewal + Dehumidification: The unit condenses partially in air and partially in water through the plate condenser, obtaining dehumidified air;
- 2- Renewal + Dehumidification + Cooling integration: The unit condenses totally in water, thus obtaining dehumidified and cooling air.

During the winter period (compressor off) the hydronic battery is powered by hot water of the heating system and behaves like a thermo-ventilated with recuperator.

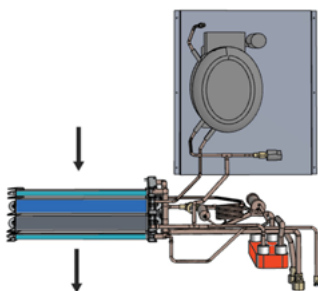

PRODUCT RANGE

NEW



5602GHWZ

CMV dehumidifier with high efficiency recuperator and renewal for ceiling installation

Code	Model	Price €	Unit/Box
558 0421	02GH-300-WZ		1/1
558 0422	02GH-500-WZ		1/1

CONTROLS



5602CON

Code	Colour	Price €	Unit/Box
558 0427	Mod-Bus <input type="checkbox"/> White		1/1

PRINCIPLE OF OPERATION

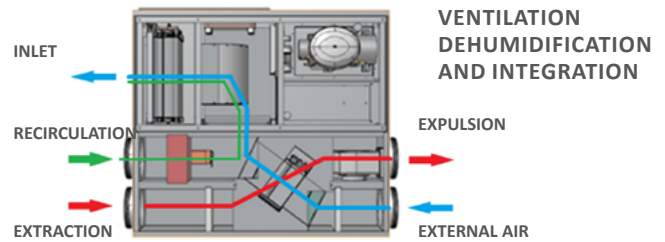

DIMENSIONAL AND TECHNICAL CHARACTERISTICS

DIMENSIONAL CHARACTERISTICS		Codes	
		558 0421	558 0422
Length	mm	880	995
Depth	mm	1070	1180
Height	mm	251	251
Local extraction diameter	Ø mm	160	160
Diameter of recirculating air	Ø mm	160	200
External air intake diameter	Ø mm	160	160
Exhaust air diameter	Ø mm	160	160
Delivery inlet connection	mm	350 x 180	515 x 240
Battery hydraulic connections	Ø	1/2" - 1/2"	1/2" - 1/2"
Condensation drain	Ø mm	18	18
Weight	kg	74	90

TECHNICAL CHARACTERISTICS		558 0421	558 0422
Ventilation air flow rate	m³/h	155	252
Integration air flow	m³/h	300	534
Useful pressure (maximum flow rate)	Pa	100	100
Type of exchanger and number		polypropylene countercurrent plates - no.1	
Recovery efficiency ^{1 2 3}	%	86,5	83,7
Filters: Type and class of filtration		Flat - F7 ePM1 70%	
Useful drying capacity	l/24h	25	40
Cooling capacity (hydraulic battery) ²	W	610	1250
Compressor cooling capacity (summer)	W	800	2020
Heat output yield ³ (winter)	W	860	1300
Winter operation water flow rate	m³/h	0,2	0,3
Battery pressure drop	kPa	6,8	6,9
Refrigerant gas		R134a	

ACOUSTIC DATA		558 0421	558 0422
Sound power Lwa	dB(A)	48	49
Average sound pressure Lp at 1 meter	dB(A)	44,7	45,5

ELECTRICAL DATA		558 0421	558 0422
Supply voltage	V	230 / 1 / 50 Hz	
Absorbed current	A	3,5	5,9
Power consumption	W	90	138
Degree of protection		IP44	

¹ External air temperature 30°C; relative humidity 60%. Ambient temperature 25°C; relative humidity 50%, Nominal air flow

² Ambient temperature 25°C; relative humidity 60%, Nominal air flow; Water 16°C

³ Ambient temperature 20°C; relative humidity 60%, Nominal air flow; Water 35°C



ACCESSORIES



5509EL

Electric post-heating battery with section circular passage, single-phase 230 V supply

Code	Conn.	Power [W]	Price €	Unit/Box
558 0458	Ø 160	800		1/1
558 0459	Ø 160	1200		1/1
558 0460	Ø 160	1600		1/1
558 0461	Ø 160	2400		1/1



5509EF

Post-heating or cooling hydraulic battery, internally insulated and with circular passage section

Code	Conn.	Power ¹ [W]	Price €	Unit/Box
558 0473	Ø 125	2000		1/1
558 0474	Ø 160	3400		1/1



5509EC

Hydraulic post heating battery with circular passage section

Code	Conn.	Power ² [W]	Price €	Unit/Box
558 0478	Ø 125	2010		1/1
558 0479	Ø 160	3420		1/1

Electric batteries:

Power output equivalent to electrical power, signal adjustment 0-10 V

² Batteries heating: Yields with water 90 °C/70 °C

¹ Insulated batteries heating/cooling: Water yields at +7 °C/+12 °C - Air +32 °C.



5601PGHM

Plenum with multiple connections to the air distribution terminals in the room

Code	Model	Fan unit	Price €	Unit/Box
558 0557	1 x Ø 160 mm	02GH-300-WZ		1/1
558 0558	1 x Ø 200 mm	02GH-500-WZ		1/1
558 0444	8 x Ø 75/90 mm	02GH-300-WZ		1/1
558 0445	12 x Ø 75/90 mm	02GH-500-WZ		1/1
558 0503	3 x Ø 125 mm	02GH-300-WZ		1/1
558 0504	5 x Ø 125 mm	02GH-500-WZ		1/1



5602FIL3

Active carbon filter kit, complete kit consisting of 3 filters

Code	Model	Fan unit	Price €	Unit/Box
558 0501	Activated carbon	02GH-300-WZ		1/1
558 0502	Activated carbon	02GH-500-WZ		1/1



5602FIL

Flat filter kit for heat recovery, filtration class F7 ePM1 70%

Code	Model	Fan unit	Price €	Unit/Box
558 0499	Flat	02GH-300-WZ (V)		1/1
558 0500	Flat	02GH-500-WZ (V)		1/1

DESCRIPTIONS

DESCRIPTION

Controlled mechanical ventilation unit with high efficiency heat recovery unit, air treatment section with dehumidification, cooling and heating. Particularly suitable for residential, commercial, or collective residential buildings and is provided plug-and-play for quick and simplified installation. Composed of one-piece including each component for proper operation within wide range of external temperature, available in 2 dimensions.

PERFORMANCE

High efficiency counter-current polypropylene heat exchanger, summer and winter operation with high performance. Brushless plug-in fans with modulating electronic motor, very high efficiency and low noise levels, Erp compliance. ePM1 filters on renewal air and spoiled extraction air upstream of heat recovery, filters with low pressure drop easily removable on recirculation air. Free cooling realized inside the unit with wide air passage and damper. Recovery efficiency greater than 90%.

STRUCTURE

Self-supporting perimeter structure in galvanized sheet, the insulation of the panels is made with 20 mm thickness high-performance insulation and 6 mm thickness insulating

adhesive polyethylene. Panels made of double sandwich panel, with external painted finish and Aluzink inside the unit.

ADVANTAGES / STRENGTH

- Easy configuration of the connections, makes the units easily adaptable to different plant requirements.
- Residential sector systems.
- Unit configured for ceiling installation.

CONTROLS

Electric board unit with microprocessor and dedicated regulation; fan management, room temperature regulation and the desired room set point, recirculation management, antifreeze function and valve management on/off water side. Mandatory control panel for unit operation with capacitive touch, integrated air quality and humidity temperature sensors.

Control panel mandatory for unit operation.

Can be combined with Climav 2.0 Building Management thermoregulation system.

Controls not included with the fan unit

PRODUCT RANGE

NEW



5502GHWZV

CMV dehumidifier with high efficiency recuperator and renewal for vertical wall or floor installation

Code	Model	Price €	Unit/Box
558 0379	02GH-300-WZV		1/1
558 0380	02GH-500-WZV		1/1

CONTROLS



5602CON

Code	Colour	Price €	Unit/Box
558 0427	Mod-Bus <input type="checkbox"/> White		1/1

PRINCIPLE OF OPERATION

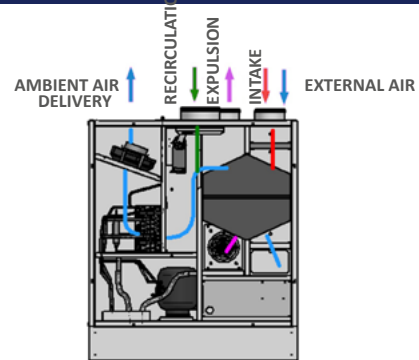

DIMENSIONAL AND TECHNICAL CHARACTERISTICS

DIMENSIONAL CHARACTERISTICS		Codes	
		558 0379	558 0380
Length	mm	885	985
Depth	mm	515	740
Height	mm	1085	1185
Local extraction diameter	Ø mm	160	160
Diameter of recirculating air	Ø mm	125	200
External air intake diameter	Ø mm	125	160
Exhaust air diameter	Ø mm	125	160
Delivery inlet connection	mm	340 x 175	515 x 240
Battery hydraulic connections	Ø	1/2" - 1/2"	1/2" - 1/2"
Condensation drain	Ø mm	20	18
Weight	kg	74	83
TECHNICAL CHARACTERISTICS		558 0379	558 0380
Ventilation air flow rate	m³/h	161	258
Integration air flow	m³/h	302	538
Useful pressure (maximum flow rate)	Pa	100	100
Type of exchanger and number		polypropylene countercurrent plates - no.1	
Recovery efficiency ^{1 2 3}	%	83,9	86
Filters: Type and class of filtration		Flat - F7 ePM1 70%	
Useful drying capacity	l/24h	22	40
Cooling capacity (hydronic battery) ²	W	530	1250
Compressor cooling capacity (summer)	W	1140	650
Heat output yield ³ (winter)	W	620	1300
Winter operation water flow rate	m³/h	0,15	0,3
Battery pressure drop	kPa	4,8	9
Refrigerant gas		R134a	
ACOUSTIC DATA			
Sound power Lwa	dB(A)	60,1	62,1
Average sound pressure Lp at 1 meter	dB(A)	46,2	40,2
ELECTRICAL DATA			
Supply voltage	V	230 / 1 / 50 Hz	
Absorbed current	A	3,5	5,9
Degree of protection		IP44	

¹ External air temperature 30°C; relative humidity 60%. Ambient temperature 25°C; relative humidity 50%, Nominal air flow

² Ambient temperature 25°C; relative humidity 60%, Nominal air flow; Water in 16°C

³ Ambient temperature 20°C; relative humidity 60%, Nominal air flow; Water in 35°C



PRICE LIST

ACCESSORIES



5509EL

Electric post-heating battery with section circular passage, single-phase 230 V supply.

Code	Conn.	Power [W]	Price €	Unit/Box
558 0458	Ø 160	800		1/1
558 0459	Ø 160	1200		1/1
558 0460	Ø 160	1600		1/1
558 0461	Ø 160	2400		1/1



5509EF

Post-heating or cooling hydraulic battery, internally insulated and with circular passage section.

Code	Conn.	Power ¹ [W]	Price €	Unit/Box
558 0473	Ø 125	2000		1/1
558 0474	Ø 160	3400		1/1

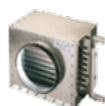

5509EC

Hydraulic post heating battery with circular passage section.

Code	Conn.	Power ² [W]	Price €	Unit/Box
558 0478	Ø 125	2010		1/1
558 0479	Ø 160	3420		1/1

Electric batteries:

Power output equivalent to electrical power, signal adjustment 0-10 V

² Batteries heating: Yields with water 90 °C/70 °C

¹ Insulated batteries heating/cooling: Water yields at +7 °C/+12 °C - Air +32 °C.



5601PGHM

Plenum with multiple connections to the air distribution terminals in the room

Code	Model	Fan unit	Price €	Unit/Box
558 0557	1 x Ø 160 mm	02GH-300-WZ		1/1
558 0558	1 x Ø 200 mm	02GH-500-WZ		1/1
558 0444	8 x Ø 75/90 mm	02GH-300-WZ		1/1
558 0445	12 x Ø 75/90 mm	02GH-500-WZ		1/1
558 0503	3 x Ø 125 mm	02GH-300-WZ		1/1
558 0504	5 x Ø 125 mm	02GH-500-WZ		1/1



5602FIL3

Active carbon filter kit, complete kit consisting of 3 filters.

Code	Model	Fan unit	Price €	Unit/Box
558 0501	Activated carbon	02GH-300-WZ (V)		1/1
558 0502	Activated carbon	02GH-500-WZ (V)		1/1



5602FIL

Flat filter kit for heat recovery, filtration class F7 ePM1 70%.

Code	Type	Fan unit	Price €	Unit/Box
558 0499	Flat	02GH-300-WZ (V)		1/1
558 0500	Flat	02GH-500-WZ (V)		1/1

DESCRIPTIONS

DESCRIPTION

Controlled mechanical ventilation unit with high efficiency heat recovery unit, air treatment section with dehumidification, cooling and heating. Particularly suitable for residential, commercial, or collective residential buildings and is provided plug-and-play for quick and simplified installation. Composed of one-piece including each component for proper operation and allows operation with wide external temperature ranges, available in 2 dimensions.

PERFORMANCE

High efficiency counter-current polypropylene heat exchanger, summer and winter operation with high performance. Brushless plug-in fans with modulating electronic motor, very high efficiency and low noise levels, Erp compliance. ePM1 filters on renewal air and spoiled extraction air upstream of heat recovery, Coarse filters with low pressure drop easily removable on recirculation air. Free cooling realized inside the unit with wide air passage and damper. Recovery efficiency greater than 90%.

STRUCTURE

Self-supporting perimeter structure in galvanized sheet, the insulation of the panels is made with 20 mm thick high-performance insulation and 6mm thick adhesive

polyethylene insulation. Panels made of double sandwich panel, with external painted finish and Aluzink inside the unit.

ADVANTAGES / STRENGTH

- Easy configuration of the connections, makes the units easily adaptable to different plant requirements.
- Residential sector systems.

CONTROLS

Electric board unit with microprocessor and dedicated regulation; fan management, room temperature regulation and the desired room set point, recirculation management, antifreeze function and valve management on/off water side. Mandatory control panel for unit operation with capacitive touch, integrated air quality and humidity temperature sensors.

Control panel mandatory for unit operation.

Controls not included with the fan unit

Dehumidifiers with air renewal are machines to be inserted typically in radiant systems to keep under control the relative humidity of the environment allowing, in parallel, the renewal of exhausted air through the use of high efficiency recuperators.

TIEMME offers two types of fan units, both with models for both ceiling and wall/floor installation;

DEU-VMC unit equipped with: high efficiency heat recuperator, dehumidification, and cooling-heating section;

DEU-VMC Hydronic unit equipped with: high efficiency heat recovery, dehumidification section, cooling-heating and additional hydronic battery.

CMV CLIMA

Particularly suitable for houses with low consumption, homes both new construction and under renovation, offices, and small business premises. Today all buildings, new or renovated, are designed with good insulation to minimize heat loss, this reduces the thermal requirement of the building and allows you to use at best low/medium temperature air conditioning systems. The greater insulation, however, brings with it the lack of air exchange with the consequence of an accumulation of moisture and micro pollutants that make the living climate unhealthy. To obtain a real living comfort, while ensuring well-being and hygiene in indoor environments, it is necessary to use a ventilation system that ensures the air exchange in a controlled manner with the recovery of heat energy otherwise dispersed.

Integrating the CMV with the air conditioning system is also an investment on the property. The installation of a highly efficient heat recovery system allows access to the highest energy classes, thus increasing their value.

DEU-VMC UNIT WITH HYDRONIC BATTERY HORIZONTAL INSTALLATION



DEU-VMC UNIT WITH HYDRONIC BATTERY VERTICAL INSTALLATION



DEU-VMC units are controlled mechanical ventilation units with high efficiency heat recovery unit, air treatment section with dehumidification, cooling, and heating. Particularly suitable for residential, commercial, or collective residential buildings, plug-and-play is provided for quick and easy installation.

The units are composed of a single unit including each component for proper operation and allow operation with wide external temperature ranges.

RECOVERY SECTION	High efficiency counter-current polypropylene heat exchanger >90%. Summer operation and winter.
VENTILATION	Brushless centrifugal fans with electronic motor and modulating control, very high efficiency and low noise levels. In compliance with Erp2018. Regulation at constant flow.
AIR TREATMENT SECTION	The unit is equipped with water battery with geometry optimized for dehumidification or integration of cooling and heating. Operation takes place at various operating temperatures of the feed water.
FILTRATION	PM1 filters on renewal air and spoiled extraction air upstream of heat recovery. Coarse filters with low pressure drop easily removable on recirculation air.
STRUCTURE	Panels made of double sandwich panel, with external painted finish and Aluzink inside the unit. Self-supporting perimeter structure in galvanized sheet. The insulation of the panels is made with 20 mm thick high performance insulation and 6 mm thick adhesive polyethylene insulation.
REGULATION	Electric panel on board unit with microprocessor and dedicated regulation. Fan management, display of internal machine temperature probes, time-controlled dirty filter management, recirculation, and renewal air management. Large black and white or colour touch graphical interface with configuration menu and multilingual user menu



PRINCIPLES OF OPERATION

OPERATION VENTILATION ONLY

The unit will meet the mechanical ventilation with high efficiency heat recovery. It will be possible to select the fan speeds in order to obtain the desired flow rate to meet the demands of air renewal.

HORIZONTAL UNIT

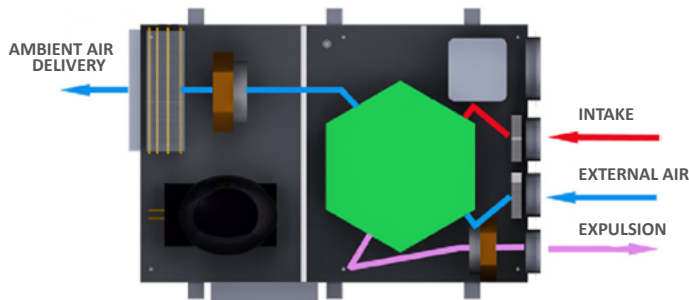

VERTICAL UNIT

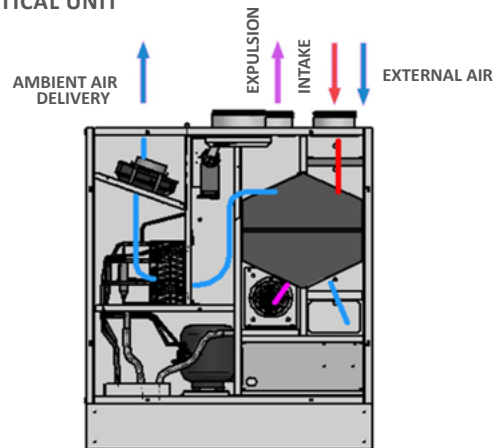

OPERATION VENTILATION, DEHUMIDIFICATION, AND INTEGRATION

The unit will continue to meet mechanical ventilation with high efficiency heat recovery but will increase the air flow, recirculating from a dedicated room air duct to increase the air volume on the integration part.

The integration part is from a version with dehumidification, integration, and integrative hydronic batteries.

The unit provides through fluid supply in winter and summer.

The battery operates with low temperature water in winter 45/40 °C and medium temperature in summer at 8/10 °C. The continuous modulation of the fans allows a high level of comfort even when heating and cooling the environment.

HORIZONTAL UNIT

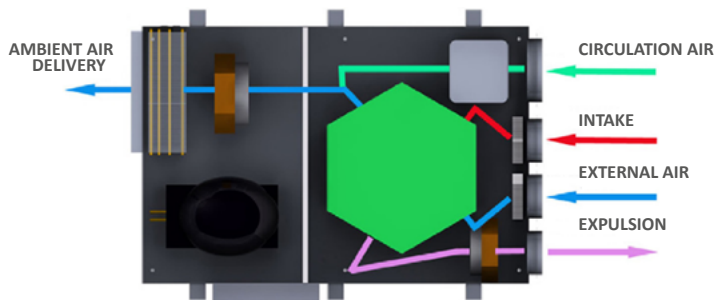

VERTICAL UNIT

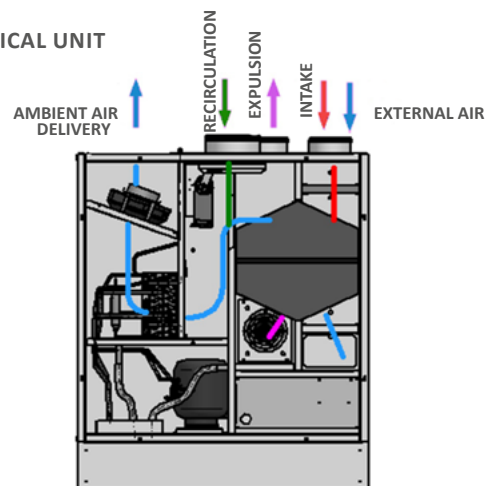

DEHUMIDIFICATION AND INTEGRATION IN COOLING/HEATING

The unit will continue to meet mechanical ventilation with high efficiency heat recovery but will increase the air flow rate, recirculating from a dedicated room air duct to increase the air volume on the integration part.

The integration part consists of a section with hydronic batteries.

The unit provides through fluid supply in winter and summer.

The battery provides operation with low temperature water in winter 45/40 °C and medium temperature in summer at 8/10 °C.

The continuous modulation of the fans allows a high level of ambient comfort even in the moment of heating and cooling of the environment.

PRODUCT RANGE

NEW



55080

Controlled mechanical ventilation unit with high efficiency heat recovery unit, dehumidification, cooling, and heating section, equipped with additional hydronic battery. Horizontal ceiling installation.

Code	Model	Price €	Unit/Box
558 0436	VMC CLIMA-H-50/25		1/1
558 0437	VMC CLIMA-H-60/15		1/1
558 0438	VMC CLIMA-H-90/25		1/1

CONTROLS



5508COM

Code	Colour	Price €	Unit/Box
957 0218	Wi-Fi ■ Black		1/1
957 0217	Wi-Fi □ White		1/1

PRINCIPLE OF OPERATION

VENTILATION, DEHUMIDIFICATION AND INTEGRATION

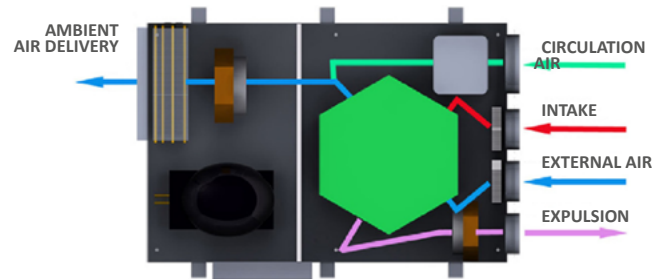

DIMENSIONAL AND TECHNICAL CHARACTERISTICS

DIMENSIONAL CHARACTERISTICS		Codes		
		558 0436	558 0437	558 0438
Length	mm	1220	1220	1220
Depth	mm	960	820	960
Height	mm	330	255	330
Recirculation air inlet diameter	∅ mm	200	200	250
Stail air intake diameter	∅ mm	160	125	160
Renewal air inlet diameter	∅ mm	160	125	160
Stail air exhaust diameter	∅ mm	160	125	160
Ambient air delivery [bxh]	mm	490 x 225	550 x 180	712 x 197
Battery hydraulic connections	∅	3/4" - 3/4"	3/4" - 3/4"	3/4" - 3/4"
Condensation drain	∅ mm	20	20	20
Weight	kg	83	74	89

TECHNICAL CHARACTERISTICS		558 0436	558 0437	558 0438
Ventilation air flow rate	m ³ /h	265	151	263
Integration air flow	m ³ /h	520	692	838
Useful pressure (maximum flow rate)	Pa	100	100	100
Type of exchanger and number		polypropylene countercurrent plates - no.1		
Filters: Type and class of filtration		Flat - F7 ePM1 70% / Coarse		
Heating power (winter data)	W	3880	4500	6800
Recovery efficiency (winter data)	%	86	86,6	86,5
Cooling capacity	W	3320	3700	5560
Recovery efficiency (summer data)	%	84	83	84
Water flow rate	l/h	700	600	900
ACOUSTIC DATA				
Sound pressure Lwa	dB(A)	66,5	64,8	67,8
Average sound pressure Lp at 1 meter	dB(A)	52,7	49,8	53,6
ELECTRICAL DATA				
Supply voltage	V	230 / 1 / 50 Hz		
Absorbed current	A	1,6	1,8	2,2
Degree of protection		IP44		

¹ External air temperature 30°C; relative humidity 60%. Ambient temperature 25°C; relative humidity 50%, Nominal air flow

² Ambient temperature 25°C; relative humidity 60%, Nominal air flow; Water 16°C

³ Ambient temperature 20°C; relative humidity 60%, Nominal air flow; Water 35°C



ACCESSORIES



5509EL

Electric post-heating battery with section circular passage, single-phase 230 V supply

Code	Conn.	Power [W]	Price €	Unit/Box
558 0458	Ø 160	800		1/1
558 0459	Ø 160	1200		1/1
558 0460	Ø 160	1600		1/1
558 0461	Ø 160	2400		1/1



5509EF

Post-heating or cooling hydraulic battery, internally insulated and with circular passage section

Code	Conn.	Power ² [W]	Price €	Unit/Box
558 0473	Ø 125	2000		1/1
558 0474	Ø 160	3400		1/1

Electric batteries:
Power output equivalent to electrical power, signal adjustment 0-10 V

² Batteries heating:
Yields with water 90 °C/70 °C

¹ Insulated batteries heating/cooling:
Water yields at +7 °C/+12 °C - Air +32 °C.



5509EC

Hydraulic post heating battery with circular passage section

Code	Model	Power ² [W]	Price €	Unit/Box
558 0478	Ø 125	2600		1/1
558 0479	Ø 160	3600		1/1



5508FIL

Flat filter kit for heat recovery, filtration class F7 ePM1 70%

Code	Model	Fan unit	Price €	Unit/Box
556 0446	Filter kit (2+1)	VMC CLIMA-H-60/15		1/1
556 0447	Filter kit (2+1)	VMC CLIMA-H-50/25 - 90/25		1/1

Activated carbon filters, available on request.
Active carbon filter kits require regular scheduled replacement to ensure effectiveness.

DESCRIPTIONS

DESCRIPTION

Controlled mechanical ventilation unit with high efficiency heat recovery unit, air treatment section with dehumidification, cooling and heating, equipped with additional hydronic battery. Available in three dimensions it is particularly suitable for residential, commercial, or collective residential buildings, provided for a quick and simplified installation. Monoblock unit including each component for correct operation at wide outdoor temperature ranges.

PERFORMANCE

Exchanger in polypropylene with cross-flow counter-current with high efficiency, low freezing temperatures and very high exchange efficiency.

Centrifugal fans Erp with electronic motor with low energy consumption.

External and supply air inlet filters with ePM1 filtration class and for recirculation.

Water battery with geometry optimized for dehumidification or integration of cooling and heating.

STRUCTURE

Aluzink sheet metal self-supporting frame with RAL9003 painted aesthetics, choice of materials with high thermal and acoustic insulation characteristics

ADVANTAGES / STRENGTH

- Easy configuration of the connections, makes the units easily adaptable to different plant requirements.
- Facilities residential sector, or small commercial.

CONTROLS

Electric panel on board unit with microprocessor and dedicated regulation. Fan management, room temperature regulation and the desired room set point. Recirculation management, antifreeze function and valve management on/off water side. Capacitive Touch control panel, integrated air quality and humidity temperature sensors.

Control panel mandatory for unit operation.

Controls not included with the fan unit

PRODUCT RANGE

NEW



5508V

Controlled mechanical ventilation unit with high efficiency heat recovery unit, air treatment with dehumidification, cooling and heating, equipped with additional hydronic battery. Vertical wall or floor installation

Code	Model	Price €	Unit/Box
558 0439	VMC CLIMA-V-50/25		1/1
558 0440	VMC CLIMA-V-60/15		1/1
558 0441	VMC CLIMA-V-90/25		1/1

CONTROLS



5508COM

Code	Colour	Price €	Unit/Box
957 0218	Wi-Fi <input checked="" type="checkbox"/> Black		1/1
957 0217	Wi-Fi <input type="checkbox"/> White		1/1

PRINCIPLE OF OPERATION

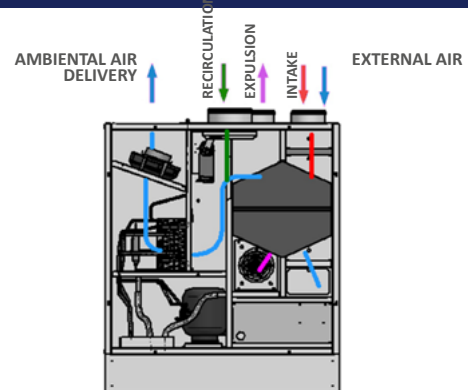

DIMENSIONAL AND TECHNICAL CHARACTERISTICS

DIMENSIONAL CHARACTERISTICS		Codes		
		558 0439	558 0440	558 0441
Length	mm	985	885	985
Depth	mm	740	515	740
Height	mm	1185	1085	1185
Recirculation air inlet diameter	∅ mm	200	200	250
Stail air intake diameter	∅ mm	160	125	160
Renewal air inlet diameter	∅ mm	160	125	160
Stail air exhaust diameter	∅ mm	160	125	160
Ambient air delivery [bxh]	mm	240 x 510	175 x 345	240 x 510
Battery hydraulic connections	∅	3/4" - 3/4"	3/4" - 3/4"	3/4" - 3/4"
Condensation drain	∅ mm	20	20	20
Weight	kg	78	70	81
TECHNICAL CHARACTERISTICS		558 0439	558 0440	558 0441
Ventilation air flow rate	m³/h	161	160	261
Integration air flow	m³/h	302	620	840
Useful pressure (maximum flow rate)	Pa	100	100	100
Type of exchanger and number		polypropylene countercurrent plates - no.1		
Filters: Type and class of filtration		Flat - F7 ePM1 70% / Coarse		
Heating power (winter data)	W	2250	4500	6800
Recovery efficiency (winter data)	%	83,9	84	85,9
Cooling capacity	W	2030	3700	5560
Recovery efficiency (summer data)	%	83	83	84
Water flow rate	l/h	400	600	900
ACOUSTIC DATA				
Sound pressure Lwa	dB(A)	60,1	62,5	64,2
Average sound pressure Lp at 1 meter	dB(A)	46,2	48,8	48,4
ELECTRICAL DATA				
Supply voltage	V	230 / 1 / 50 Hz		
Absorbed current	A	1,6	1,8	2,2
Degree of protection		IP44		

¹ External air temperature 30°C; relative humidity 60%. Ambient temperature 25°C; relative humidity 50%, Nominal air flow

² Ambient temperature 25°C; relative humidity 60%, Nominal air flow; Water in 16°C

³ Ambient temperature 20°C; relative humidity 60%, Nominal air flow; Water in 35°C



PRICE LIST

ACCESSORIES



5509EL

Electric post-heating battery with section circular passage, single-phase 230 V supply

Code	Conn.	Power [W]	Price €	Unit/Box
558 0458	Ø 160	800		1/1
558 0459	Ø 160	1200		1/1
558 0460	Ø 160	1600		1/1
558 0461	Ø 160	2400		1/1



5509EF

Post-heating or cooling battery with hydraulic battery, internally insulated and with circular passage section

Code	Conn.	Power ¹ [W]	Price €	Unit/Box
558 0473	Ø 125	2000		1/1
558 0474	Ø 160	3400		1/1

Electric batteries:
Power output equivalent to electrical power, signal adjustment 0-10 V

² Batteries heating:
Yields with water 90 °C/70 °C

¹ Insulated batteries heating/cooling:
Water yields at +7 °C/+12 °C - Air +32 °C.



5509EC

Post heating battery with hydraulic battery with circular passage section

Code	Model	Power ² [W]	Price €	Unit/Box
558 0478	Ø 125	2600		1/1
558 0479	Ø 160	3600		1/1



5508FIL

Flat filter kit for heat recovery, filtration class F7 ePM1 70%

Code	Model	Fan unit	Price €	Unit/Box
556 0448	Filter kit (2+1)	CLIMA-V-60/15		1/1
556 0449	Filter kit (2+1)	CLIMA-V (50/25 - 90/25)		1/1

Activated carbon filters, available on request.
Active carbon filter kits require regular scheduled replacement to ensure effectiveness.

DESCRIPTIONS

DESCRIPTION

Controlled mechanical ventilation unit with high efficiency heat recovery unit, air treatment section with dehumidification, cooling and heating, equipped with additional hydronic battery. Available in three dimensions it is particularly suitable for residential, commercial, or collective residential buildings, provided for a quick and simplified installation. Monoblock unit including each component for correct operation at wide outdoor temperature ranges.

PERFORMANCE

Exchanger in polypropylene with cross-flow counter-current with high efficiency, low freezing temperatures and very high exchange efficiency.

Centrifugal fans Erp with electronic motor with low energy consumption.

External and supply air inlet filters with ePM1 and Coarse filtration class for recirculation.

Water battery with geometry optimized for dehumidification or integration of cooling and heating.

STRUCTURE

Aluzink sheet metal self-supporting frame with RAL9003 painted aesthetics, choice of materials with high thermal and acoustic insulation characteristics

ADVANTAGES / STRENGTH

- Easy configuration of the connections, makes the units easily adaptable to different plant requirements.
- Facilities residential sector, or small commercial.

CONTROLS

Electric panel on board unit with microprocessor and dedicated regulation. Fan management, room temperature regulation and the desired room set point. Recirculation management, antifreeze function and valve management on/off water side. Capacitive Touch control panel, integrated air quality and humidity temperature sensors.

Control panel mandatory for unit operation.

Controls not included with the fan unit

TIEMME offers a new and wide range of fan coil units, which aims to offer the best solution for the needs of efficiency, design, and comfort for the system requirements in every residential and commercial application.

High performance with reduced operating consumption, through the use of Brushless DC motors with high silence, available in different versions for punctual management, centralized or able to interface with advanced systems of home automation and climate control.

RANGE

The range consists of different models and types of terminals, for multi-zone management from a single fan unit, to the classic wall or ceiling cabinets, wall units with adjustable split type, up to the ultra-flat models for wall built-in installation in combination with counter case and front panel or installation by plenum kit with delivery and air intake grilles.

ART. 5603FAN

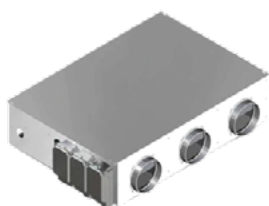

Ductable fan coil unit for direct multi-zone management, motors with electronic management for each single served area, in version without regulation with 0-10V control or with direct remote regulation for single zone. Horizontal ceiling installation.

ART. 5608FAN



Ultra-flat fan coil unit for wall or ceiling installation with additional condensate collection tray, available with integrated touch control and Modbus or 0-10V analog connection.

ART. 5607FAN

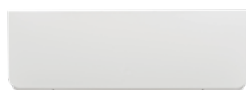

Ultra slim fan coil unit for wall installation, equipped with double condensate collection basin for reversible installation. Possibility of coupling to 3-way valve, available in two control versions, with integrated touch control and Modbus or 0-10V analog connection.

ART. 5604FAN



Ultra-flat fan coil unit for vertical installation on the wall or in the false ceiling. Classic wall built-in with back-box and front panel or it can be combined with plenum kit and delivery and return grilles, for wall or false ceiling installation. Available with integrated touch control and Modbus or 0-10V analog connection.

Reliable and versatile terminals, suitable for the combination of the most modern systems, thanks to their efficiency characteristics even at medium water temperatures in the inlet to the batteries, ensuring optimal yields for every plant requirement.

In the models for wall or ceiling installation, maximum installation versatility, also guaranteed by the small dimensions and built-in depth of the ventilating units, without compromising the yields and the ability to satisfy the demands of plant type.





PRODUCT RANGE

NEW



5603FAN

Ductable fan coil for direct multi-zone management, motors with electronic management in every single served area, in version without regulation with 0-10V control or with direct remote regulation for single zone. Horizontal ceiling installation. Hydraulic connections on the right

Code	Model	Regulation	Price €	Unit/Box
558 0505	Zone 2	0-10 V		1/1
558 0506	Zone 3	0-10 V		1/1
558 0507	Zone 4	0-10 V		1/1
558 0508	Zone 5	0-10 V		1/1
558 0509	Zone 2	Remote control		1/1
558 0510	Zone 3	Remote control		1/1
558 0511	Zone 4	Remote control		1/1
558 0512	Zone 5	Remote control		1/1

CONTROLS



5508COM

Code	Colour	Price €	Unit/Box
957 0218	Wi-Fi Black		1/1
957 0217	Wi-Fi White		1/1

PRINCIPLE OF OPERATION

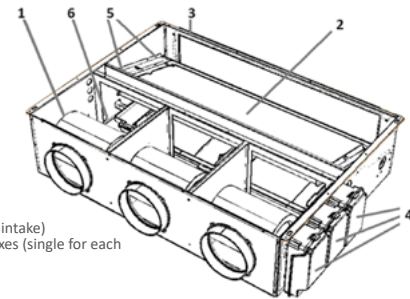

- 1- Fans
- 2- Hydronic battery
- 3- Filter (installation on air intake)
- 4- Electrical connection boxes (single for each motor)
- 5- Hydraulic connections
- 6- Condensate drain

DIMENSIONAL AND TECHNICAL CHARACTERISTICS

DIMENSIONAL CHARACTERISTICS		Codes			
		558 0505 558 0509	558 0506 558 0510	558 0507 558 0511	558 0508 558 0512
Mounting plate width	mm	790	990	1190	1480
Depth	mm	690			
Height	mm	240			
Air intake	mm	630 x 150	830 x 150	1030 x 150	1320 x 150
Air connection diameters	∅ mm	2 x 160	3 x 160	4 x 160	5 x 160
Hydraulic connections for delivery/return of the battery	∅	3/4"			
Condensation drain	∅ mm	16/20			
Weight	kg	43	47	56	67
TECHNICAL CHARACTERISTICS		558 0505 558 0509	558 0506 558 0510	558 0507 558 0511	558 0508 558 0512
GENERAL DATA		ZONE 2	ZONE 3	ZONE 4	ZONE 5
Maximum nominal air flow rate	m ³ /h	600	900	1200	1800
Single fan air flow rate (Maximum speed)	m ³ /h	300			
Single fan air flow rate (Minimum speed)	m ³ /h	60			
Hydraulic head	Pa	100			
COOLING DATA					
Total cooling capacity ¹	W	3800	5500	7200	8100
Sensitive cooling capacity ¹	W	2700	3900	5100	6100
Water flow rate	l/h	600	950	1200	1400
Pressure drop	kPa	29	21	19	11
THERMAL DATA					
Maximum total thermal power ²	W	3900	5700	7420	9000
Water flow rate	m ³ /h	610	980	1300	1570
Pressure drop	kPa	29	22	21	12
Total heat output single area ²	W	2200			
Lw sound power transmitted by the structure	dB(A)	60	61	62	64
Average sound pressure Lp at 1m	dB(A)	46	48	49	51
Supply		230 / 1 / 50 Hz			
Maximum power consumption	W	190	280	370	460
Maximum current absorbed	A	0,7	1,4	2,1	2,8

¹ Water temperature 7/12 °C, ambient air temperature 27 °C d.b. and 19 °C h.b. (EU regulation 2016/2281).

² Water temperature 45/40 °C, ambient air temperature 20 °C (EU regulation 2016/2281)
Sound data refer to the standard UNI EN 3741 and UNI EN 3744



PRICE LIST

ACCESSORIES



5603PL
Intake plenum for multi-zone fan coil unit Ø 160mm connections

Code	Conn.	Fan unit	Price €	Unit/Box
558 0513	2 x Ø 160	ZONE 2 (010-REG)		1/1
558 0514	3 x Ø 160	ZONE 3 (010-REG)		1/1
558 0515	4 x Ø 160	ZONE 4 (010-REG)		1/1
558 0516	5 x Ø 160	ZONE 5 (010-REG)		1/1



2138
Motorized 2-way male/female ball valve with servo control

Code	Model	Supply	Price €	Unit/Box
213 0003	2 ways	230 V		1/14
213 0032	2 ways	24 V		1/14



5603FIL
Replacement filter kit for multi-zone fan coil units

Code	Model	Fan unit	Price €	Unit/Box
558 0517	630 x 150	ZONE 2 (010-REG)		1/1
558 0518	830 x 150	ZONE 3 (010-REG)		1/1
558 0519	1030 x 150	ZONE 4 (010-REG)		1/1
558 0520	1320 x 150	ZONE 5 (010-REG)		1/1



2134
Motorized ball valve 3-way diverter - connections to 3 nozzles - with servo control

Code	Model	Supply	Price €	Unit/Box
213 0009	3 ways	230 V		1/4
213 0036	3 ways	24 V		1/4

DESCRIPTIONS

DESCRIPTION

Fan coil for ceiling installation, for multi-zone management from 2 to 5 environments, by fans equipped with individually powered and regulated motors.

Ductable delivery for each fan, single ductable intake with accessory, filter installed directly on the intake and hydraulic battery adjustable by installation of valves 2 or 3 ways.

PERFORMANCE

EC centrifugal fans with low energy consumption with forward blades and low noise, for the management of each individual area.

Heat exchange battery optimized for maximum performance in summer and winter operation.

STRUCTURE

High resistance structure with self-supporting frame in galvanized sheet and internal insulation with materials with high thermal and acoustic insulation characteristics.

Single filter of flat type, installed on the recovery unit, with Coarse filtration sinks easy removal for maintenance.

ADVANTAGES / STRENGTH

- Multi-zone management with single fan unit.
- Single ductable intake (with accessory).
- Low height for easy ceiling installation.

CONTROLS

Electric panel with fan speed management board, operating and temperature mode.

Mandatory control panel with Wi-Fi module for unit operation and control via local or remote application.

- Remote panel with integrated T-H probe;
- Digital inputs
- Can be combined with Climav 2.0 Building Management thermoregulation system.

Controls not included with the fan unit

PRODUCT RANGE

NEW



5608FAN

Ultra-flat fan coil for wall or horizontal ceiling installation with additional condensate collection basin, available with integrated touch control and Modbus or analog and digital 4-speed connection

Code	Model	Regulation	Price €	Unit/Box
558 0521	200 - 010	0-10 V		1/1
558 0522	400 - 010	0-10 V		1/1
558 0523	600 - 010	0-10 V		1/1
558 0524	800 - 010	0-10 V		1/1
558 0525	200 - REG	Touch control on board or remote Modbus		1/1
558 0526	400 - REG	Touch control on board or remote Modbus		1/1
558 0527	600 - REG	Touch control on board or remote Modbus		1/1
558 0528	800 - REG	Touch control on board or remote Modbus		1/1

CONTROLS



5514

Code	Model	Price €	Unit/Box
957 0229	LCD control		1/1

Can only be combined with Modbus regulation models

PRINCIPLE OF OPERATION

FLOOR



WALL



CEILING



Installazione a soffitto con integrazione di bacinella raccolta condensa. (ACCESSORIESes)

DIMENSIONAL AND TECHNICAL CHARACTERISTICS

DIMENSIONAL CHARACTERISTICS		Codes			
		558 0521 558 0525	558 0522 558 0526	558 0523 558 0527	558 0524 558 0528
Length	mm	697	897	1097	1297
Depth	mm	129			
Total height with feet	mm	659			
Cabinet height only	mm	579			
Battery hydraulic connections		3/4"			
Weight	kg	13	15	17	20

TECHNICAL CHARACTERISTICS		Codes											
		558 0521 558 0525	558 0522 558 0526	558 0523 558 0527	558 0524 558 0528								
GENERAL DATA		200		400		600		800					
Fan speed		Min.	Med.	Max.	Min.	Med.	Max.	Min.	Med.	Max.	Min.	Med.	Max.
Reference air flow rate	m ³ /h	100	130	160	190	250	320	280	360	460	350	450	575
Battery water content	l	0,47		0,80		1,13		1,46					
COOLING DATA													
Total cooling capacity ¹	W	380	710	820	910	1340	1740	1500	2100	2540	1980	2690	3290
Sensitive cooling capacity ¹	W	260	500	640	650	1020	1250	1100	1560	1940	1540	2090	2540
Water flow rate ¹	l/h	66,2	123,3	142,9	157,6	232	302,5	259,2	363,1	440,3	341,9	464,7	570
Pressure drop ¹	kPa	3,8	10,6	13,1	2,4	5,5	8,2	7,5	14,2	19	7,3	13,8	18,7
HEATING DATA													
Total heat output ²	W	640	840	1050	1250	1650	2310	1750	2560	3120	2210	3100	4100
Water flow rate	l/h	66,2	123,3	142,9	157,6	232	302,5	259,2	363,1	440,3	341,9	464,7	570
Pressure drop	kPa	3,2	8,8	10,9	2	4,6	6,8	6,2	11,8	15,8	6,1	11,5	15,5
Total heat output ³	W	540	700	880	1060	1390	1940	1460	2140	2600	1850	2600	3440
Water flow rate	l/h	91,9	119,9	150	181,9	238,1	330,3	250,6	365,7	444,6	316,6	444,8	587,9
Pressure drop	kPa	5,7	8,8	12,2	2,9	4,8	7,9	5,8	11,8	16	4,1	8,9	14,2
SOUND DATA (referring to UNI EN 3741 and UNI EN 3744)													
Sound power Lw	dB(A)	38	45	52	39	46	53	41	47	53	42	48	54
Average sound pressure Lp at 3m	dB(A)	29	36	43	30	37	44	32	38	44	33	39	45
ELECTRICAL DATA													
Supply		230 / 1 / 50 Hz											
Maximum power consumption	W	5	7	11	6	9	19	7	11	20	8	12	24

¹ Air temperature 27 °C d.b., 19 °C h.b. inlet water temperature 7°C, outlet water temperature 12°C.

² Air temperature 20 °C d.b., 15 °C max h.b. max, inlet water temperature 50°C (water flow rate equal to standard cooling conditions).

³ Air temperature 20 °C d.b., 15 °C max h.b. max, inlet water temperature 45°C, outlet water temperature 40°C.

Measured air flow rate with clean filters.



ACCESSORIES



5608BAC

Condensate collection basin for horizontal ceiling installation

Code	Model	Price €	Unit/Box
558 0529	Basin size 200		1/1
558 0530	Basin size 400		1/1
558 0531	Basin size 600		1/1
558 0532	Basin size 800		1/1



5508PIE 5508ST

Feet for masking floor mounts (only aesthetic function).

To be combined with brackets 5508ST

Code	Model	Fan unit	Price €	Unit/Box
558 0534	Feet	All		1/1
558 0556	Brackets	All		1/1



5605

Hydraulic connections reversal extension (right - left)

Code	Model	Price €	Unit/Box
558 0533	All units extension controls		1/1



5606

Electronic 3-way valve 4 wires for wall model

Code	Model	Supply	Price €	Unit/Box
558 0535	Thermo-el. valv	230 V		1/1

CONTROL CONFIGURATION

TOUCH CONTROL + MODBUS

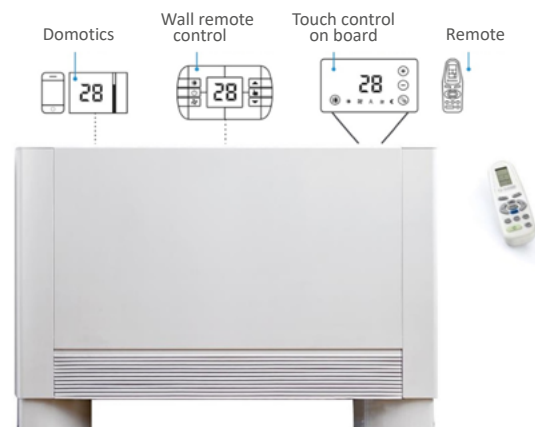

- Touch control with Modbus- Control
- IR remote control
- Kit installed on board

ANALOG 0-10V + DIGITAL 4 SPEED

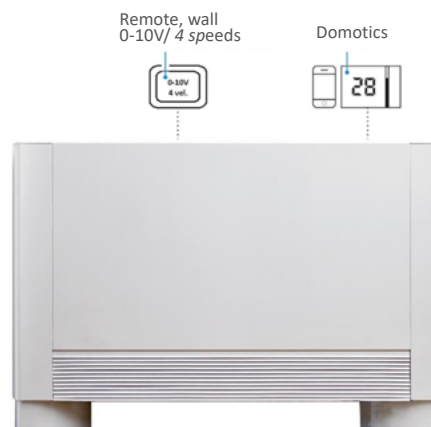

- Remote control with 0-10V signal
- Remote control 4 speeds

DESCRIPTIONS

DESCRIPTION

Ultra-flat fan coil unit for vertical installation outside wall or horizontal ceiling, made entirely of metal, steel frame and closing panels in painted metal. Front air intake grilles and upper air delivery made of painted metal.

Available in 4 power dimensions:

Heating: 900 to 3400 W;
Cooling: 800 to 3300 W.

PERFORMANCE

Brushless fans with low energy consumption and low noise. Heat exchange battery optimized to maximize the yield in summer and winter operation and reduce the pressure drop when the air passes.

STRUCTURE

High resistance structure with self-supporting frame in galvanized sheet and internal insulation with materials with high thermal and acoustic insulation characteristics. Single filter of flat type, installed on the recovery unit, easy to remove for maintenance.

ADVANTAGES / STRENGTH

- Minimum encumbrance for wall installation in room.
- Possibility of ceiling installation with the addition of condensate collection basin (accessory).

CONTROLS

Available in two versions for control and management; Control with integrated touch panel and Modbus; Analog connection 0-10V digital 4 speed.

Can be combined with Climav 2.0 Building Management thermoregulation system.

Controls not included with the fan unit

PRODUCT RANGE

NEW

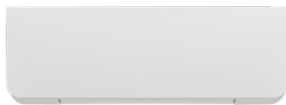

5607FAN

Ultra slim fan coil unit for wall mounting, equipped with double condensate collection basin for reversible installation. Equipped as standard with 3-way valve, available in two control versions, with integrated touch control and Modbus or 0-10V analog and 4-speed digital management

Code	Model	Regulation	Price €	Unit/Box
558 0536	400 - 010	0-10 V		1/1
558 0537	600 - 010	0-10 V		1/1
558 0538	800 - 010	0-10 V		1/1
558 0539	400 - REG	Touch control on board or remote Modbus		1/1
558 0540	600 - REG	Touch control on board or remote Modbus		1/1
558 0541	800 - REG	Touch control on board or remote Modbus		1/1

CONTROLS



5514

Code	Model	Price €	Unit/Box
957 0229	LCD control		1/1

Can only be combined with Modbus regulation models

PRINCIPLE OF OPERATION

HIGH, WALL



CONSOLE



DIMENSIONAL AND TECHNICAL CHARACTERISTICS

DIMENSIONAL CHARACTERISTICS		Codes		
		558 0536 558 0539	558 0537 558 0540	558 0538 558 0541
Length	mm	906	1106	1306
Depth (upper)	mm		150	
Depth (lower)	mm		129	
Height	mm		380	
Battery hydraulic connections			3/4"	
Weight	kg	13	14,5	16

TECHNICAL CHARACTERISTICS		558 0536 558 0539			558 0537 558 0540			558 0538 558 0541		
		400			600			800		
GENERAL DATA		Min.	Med.	Max.	Min.	Med.	Max.	Min.	Med.	Max.
Fan speed										
Reference air flow rate	m ³ /h	140	190	290	190	260	400	200	280	430
Battery water content	l	0,3			0,4			0,5		
Maximum operating pressure	bar	8								
DATI RAFFRESCAMENTO										
Total cooling capacity ¹	W	520	710	1010	690	890	1230	770	1090	1820
Sensitive cooling capacity ¹	W	420	590	910	580	800	1150	650	950	1470
Water flow rate ¹	l/h	90,6	124	177	120,1	155,1	215,5	134	189,7	317,7
Pressure drop ¹	kPa	2,8	5,2	8,9	4,9	6	7,9	2,1	4,8	11
HEATING DATA										
Total heat output ²	W	670	990	1550	980	1370	2160	1140	1680	2850
Water flow rate	l/h	90,6	124	177	120,1	155,1	215,5	134	189,7	317,7
Pressure drop	kPa	2,4	4,5	7,1	1,9	2,9	2,5	2	4,6	8,8
Total heat output ³	W	580	860	1400	860	1200	1900	990	1450	2500
Water flow rate	l/h	99,1	146,3	237,5	146,5	204,6	322,8	168,1	247,8	425,4
Pressure drop	kPa	3,4	6,7	11,6	6,7	11,9	5,4	8,5	16,4	15,3
SOUND DATA (referring to UNI EN 3741 and UNI EN 3744)										
Sound power Lw	dB(A)	43	49	57	43	50	58	43	50	58
Average sound pressure Lp at 3m	dB(A)	34	40	48	34	41	49	34	41	49
ELECTRICAL DATA										
Supply		230 / 1 / 50 Hz								
Maximum power consumption	W	7	11	19	8	12	23	9	13	27

¹ Air temperature 27 °C d.b., 19 °C h.b., inlet water temperature 7°C, outlet water temperature 12°C.

² Air temperature 20 °C d.b., 15 °C max h.b. max, inlet water temperature 50°C (with water flow equal to standard cooling conditions).

³ Air temperature 20 °C d.b., 15 °C max h.b. max, inlet water temperature 45°C, outlet water temperature 40°C.

Measured air flow rate with clean filters.



CONTROL CONFIGURATION

TOUCH CONTROL + MODBUS

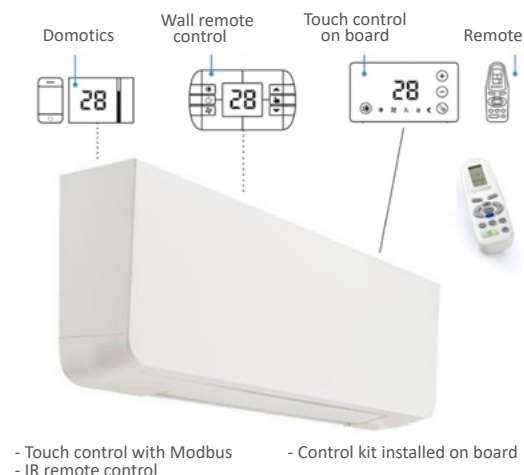

ANALOG 0-10V + DIGITAL 4 SPEED



DESCRIPTIONS

DESCRIPTION

Ultra flat fan coil unit for vertical wall installation, made with metal shell and sides in ABS, motorized air delivery flap.

Unit designed for reversible installation, high wall installation with downward discharge or low wall installation with upward discharge.

Available in 3 power dimensions:

Heating: 1400 to 2500 W;

Cooling: 1000 to 1800 W.

PERFORMANCE

Brushless fans with low energy consumption and low noise. Heat exchange battery optimized to maximize the yield in summer and winter operation and reduce the pressure drop when the air passes.

STRUCTURE

High strength structure with self-supporting metal frame and sides of ABS cover.

ADVANTAGES / STRENGTH

- Minimum encumbrance for wall installation in room.
- Reversible installation possible.
Air delivery down or air delivery up.

CONTROLS

- Available in two versions for control and management;
- Control with integrated touch panel and Modbus;
 - Analog connection 0-10V digital, 4 speed.
 - Can be combined with Climav 2.0 Building Management thermoregulation system.

Controls not included with the fan unit

ACCESSORIES



5604A

Galvanized sheet formwork for built-in installation. (combination with 5604P)

Code	Dimensions	Fan unit	Price €	Unit/Box
556 0434	713 x 142 x 725 mm	200 (010-REG)		1/1
556 0435	913 x 142 x 725 mm	400 (010-REG)		1/1
556 0436	1113 x 142 x 725 mm	600 (010-REG)		1/1
556 0437	1313 x 142 x 725 mm	800 (010-REG)		1/1



5604P

Front panel closure and infill for wall built-in installation. (combined with 5604A)

Code	Dimensions	Fan unit	Price €	Unit/Box
556 0438	772,5 x 754 x 9,2 mm	200 (010-REG)		1/1
556 0439	972,5 x 754 x 9,2 mm	400 (010-REG)		1/1
556 0440	1172,5 x 754 x 9,2 mm	600 (010-REG)		1/1
556 0441	1372,5 x 754 x 9,2 mm	800 (010-REG)		1/1



5604GRI

Supply and air intake grilles, double order of fins, made with aluminium finishes. Wall or ceiling installation. (not compatible with 5604A and 5604P)

Code	Model	Fan unit	Price €	Unit/Box
556 0418	Delivery grille	200 (010-REG)		1/1
556 0419	Delivery grille	400 (010-REG)		1/1
556 0420	Delivery grille	600 (010-REG)		1/1
556 0421	Delivery grille	800 (010-REG)		1/1
556 0422	Intake grille	200 (010-REG)		1/1
556 0423	Intake grille	400 (010-REG)		1/1
556 0424	Intake grille	600 (010-REG)		1/1
556 0425	Intake grille	800 (010-REG)		1/1



5604PL

Delivery telescopic plenum, made of metal sheet for horizontal installation in false ceiling

Code	Dimensions	Fan unit	Price €	Unit/Box
556 0426	305 x 600 x 90 mm	200 (010-REG)		1/1
556 0427	505 x 600 x 90 mm	400 (010-REG)		1/1
556 0428	705 x 600 x 90 mm	600 (010-REG)		1/1
556 0429	905 x 600 x 90 mm	800 (010-REG)		1/1



5604PL01

Diverter plenum 90°, suitable for wall built-in installation or horizontal ceiling installation, suitable for delivery

Code	Dimensions	Fan unit	Price €	Unit/Box
556 0430	335 x 600 x 93 mm	200 (010-REG)		1/1
556 0431	535 x 600 x 93 mm	400 (010-REG)		1/1
556 0432	735 x 600 x 93 mm	600 (010-REG)		1/1
556 0433	935 x 600 x 93 mm	800 (010-REG)		1/1



5604PL02

Suction plenum for wall built-in installation or ceiling or false ceiling installation. (not compatible with 5604A and 5604P)

Code	Dimensions	Fan unit	Price €	Unit/Box
556 0442	335 x 113 x 130 mm	200 (010-REG)		1/1
556 0443	535 x 113 x 130 mm	400 (010-REG)		1/1
556 0444	735 x 113 x 130 mm	600 (010-REG)		1/1
556 0445	935 x 113 x 130 mm	800 (010-REG)		1/1



5606

3-way thermoelectric valve with 4 wires for wall model

Code	Model	Fan unit	Price €	Unit/Box
558 0535	3 ways	230 V		1/1

DESCRIPTIONS

DESCRIPTION

Ultra-flat fan coil unit for vertical or false ceiling installation.

PERFORMANCE

Brushless centrifugal fans with low energy consumption and low noise. Heat exchange battery optimized to maximize the yield in summer and winter operation and reduce the pressure drop when the air passes.

STRUCTURE

High strength structure with self-supporting metal frame.

ADVANTAGES / STRENGTH

- Small footprint for built-in installation.

CONTROLS

Available in two versions for control and management;

- Control with integrated touch panel and Modbus;
- Analog connection 0-10V digital, 4 speed.
- Can be combined with Climav 2.0 Building Management thermoregulation system.

Controls not included with the fan unit

The use of controlled mechanical ventilation systems, in modern plant solutions, contribute to ensuring not only the increase in energy efficiency but also the improvement of comfort conditions in the environment.

In some situations, due to the temperature conditions of the intake air and of the flow that affects the occupants in the environment, the comfort sought is less even if the fan units are equipped with high efficiency heat recovery units.

The first measure to remedy the problem consists in the correct evaluation of the installation position of the diffusion terminals in the environment, to ensure a correct flow and movement of air in the treated rooms. Architectural or distribution constraints do not always allow the correct positioning of the diffusion terminals, making it necessary to raise the air intake temperature in the room or by preheating the inlet temperature to the fan unit coming from outside. In this case it is possible to resort to the use of special heating batteries, or preheating with electric operation, or with hydronic battery powered by water from the heating system.

POST- HEATING ELECTRIC BATTERY



ELECTRICAL RESISTANCES

They have the advantage of not requiring hydraulic connections, not always easy to build, at the expense of high energy consumption values for supplying the resistances. They can perform the function of pre-heating, with anti-freeze function for the intake air, by installing the battery between the external air intake and the fan unit. This makes it possible to avoid condensate freezing in the heat recovery unit.

POST- HEATING HYDRONIC BATTERY

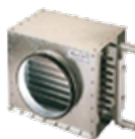

HYDRONIC BATTERIES

They exploit the heat produced by the heat generator to serve the heating or air conditioning system, but require the realization of dedicated hydraulic connections and the realization of condensate drainage.

They have as main advantage the energy savings compared to electric batteries, at the expense of larger dimensions favouring the thermal exchange of air, during the passage in the battery powered by water, to ensure the power output.

POST-HEATING POST - COOLING INSULATED HYDRONIC BATTERY



BATTERIES WITH ELECTRICAL RESISTANCE

HYDRONIC BATTERY POWERED BY WATER

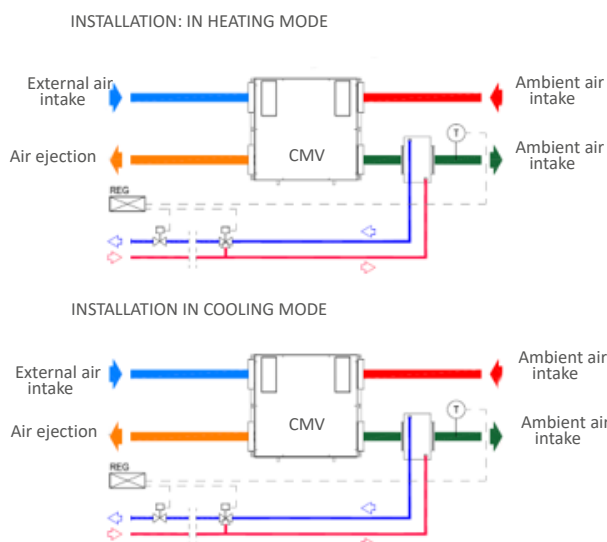
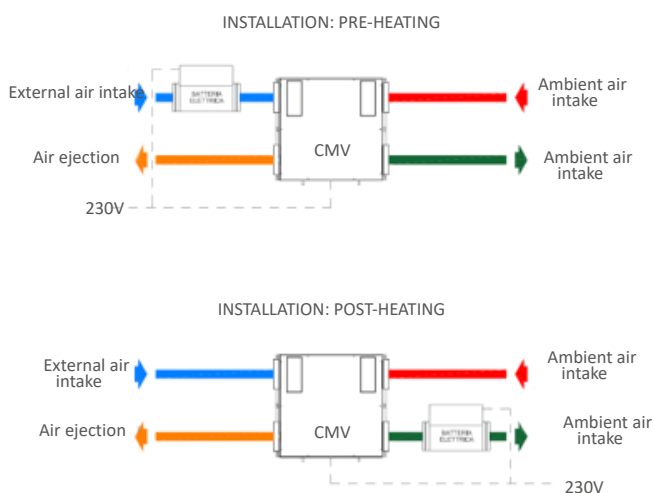

In choosing the correct battery to meet the plant demand, it should always be considered that the heat transferred to the air flow is always of a sensitive type, not intervening in the change of the absolute amount of water vapor contained in the air.

The water batteries can also be used for air conditioning, cooling the air flow from the recuperator of the fan unit and intended for distribution in local environments to be treated. In this case, the post cooling does not have the function of increasing environmental comfort but has an integrative function to the summer air conditioning, requiring proper sizing and the creation of an adequate condensate collection and drainage network.



PRODUCT RANGE

NEW



5509EL

Electric post heating batteries with circular section with integrated flow temperature regulation. Perfect air tightness thanks to the seals on the channel connection sections. Single-phase supplying

ADVANTAGES/STRENGTH

- Integrated thermal protection
- Installation anywhere in the duct and in any position
- Terminal heating battery

STRUCTURE

Round galvanized steel case, armoured heating elements in stainless steel with single-phase power supply, safety thermostat with automatic reset at 60 °C (not connected), safety thermostat with manual reset 120 °C (not connected), protection index IP40. Including channel probe for flow temperature control from 0 to +30 °C IP55 protection

Code	Model	Price €	Unit/Box
558 0458	POST EL 160-08		1/1
558 0459	POST EL 160-12		1/1
558 0460	POST EL 160-16		1/1
558 0461	POST EL 160-24		1/1
558 0462	POST EL 200-06		1/1
558 0463	POST EL 200-12		1/1
558 0464	POST EL 200-20		1/1
558 0465	POST EL 200-30		1/1
558 0466	POST EL 250-06		1/1
558 0467	POST EL 250-15		1/1
558 0468	POST EL 250-20		1/1
558 0469	POST EL 250-30		1/1
558 0470	POST EL 315-15		1/1
558 0471	POST EL 315-20		1/1
558 0472	POST EL 315-30		1/1

DIMENSIONAL AND TECHNICAL CHARACTERISTICS

Code	Model	A [mm]	B [mm]	C [mm]	D [mm]
558 0458	POST EL 160-08				
558 0459	POST EL 160-12				
558 0460	POST EL 160-16	260	380	40	160
558 0461	POST EL 160-24				
558 0462	POST EL 200-06				
558 0463	POST EL 200-12	320	380	40	200
558 0464	POST EL 200-20				
558 0465	POST EL 200-30				
558 0466	POST EL 250-06				
558 0467	POST EL 250-15	375	380	40	250
558 0468	POST EL 250-20				
558 0469	POST EL 250-30				
558 0470	POST EL 315-15				
558 0471	POST EL 315-20	445	380	40	315
558 0472	POST EL 315-30				

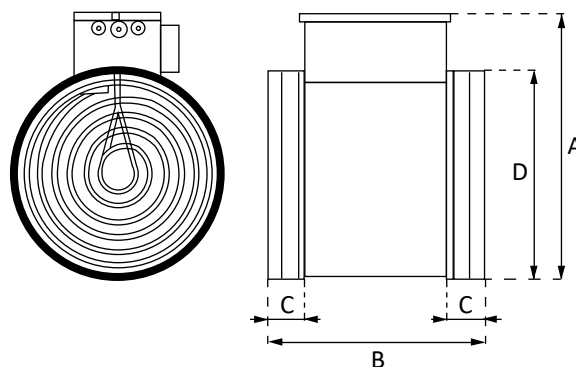

Code	Model	Connection Ø [mm]	Power [W]	Absorption [A]	Minimum flow rate [m³/h]	Weight [kg]
558 0458	POST EL 160-08	160	800	3,5	48	4
558 0459	POST EL 160-12	160	1200	5,2	71	4
558 0460	POST EL 160-16	160	1600	7	95	4,3
558 0461	POST EL 160-24	160	2400	10,4	142	4,3
558 0462	POST EL 200-06	200	600	2,8	36	4,1
558 0463	POST EL 200-12	200	1200	5,2	71	4,1
558 0464	POST EL 200-20	200	2000	8,7	118	4,5
558 0465	POST EL 200-30	200	3000	13,2	177	4,6
558 0466	POST EL 250-06	250	600	2,8	36	4,2
558 0467	POST EL 250-15	250	1500	5,2	89	4,3
558 0468	POST EL 250-20	250	2000	8,7	118	4,6
558 0469	POST EL 250-30	250	3000	13,2	177	4,6
558 0470	POST EL 315-15	315	1500	6,5	89	5,8
558 0471	POST EL 315-20	315	2000	6,7	118	6,3
558 0472	POST EL 315-30	315	3000	13,2	117	5,8

PRODUCT RANGE

NEW

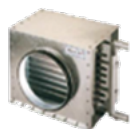

5509EC

Batteries with hot water operation for heating, with circular section of connection. Terminal battery ideal for post heating in combination with ventilation units for residential installations

ADVANTAGES/STRENGTH

- Regulation by means of 2-way valve;
- Terminal heating battery;
- Pipe fitting with sealing gasket.

STRUCTURE

Steel case with circular connection fittings made of galvanized steel and equipped with sealing gasket, hot water battery with aluminium fins and copper pipes with steel collectors.

ACCESSORIES

Motorized valves for regulating the flow to the internal battery, actuators with 230 V and 24 V power supply

Code	Model	Price €	Unit/Box
558 0478	POST EC 125-2600		1/1
558 0479	POST EC 160-3600		1/1
558 0480	POST EC 200-4800		1/1
558 0481	POST EC 250-7700		1/1
558 0482	POST EC 315-12500		1/1

Model indications for connection and power:
POST EC DN (mm) - Power (W)

DIMENSIONAL AND TECHNICAL CHARACTERISTICS

Code	Model	A [mm]	B [mm]	C [mm]	D [mm]	E [mm]	Battery conn. [Ø]	Weight [kg]
558 0478	POST EC 125-2600	245	180	125	110	280	1/2"	17,5
558 0479	POST EC 160-3600	270	205	160	110	280	1/2"	18,3
558 0480	POST EC 200-4800	295	230	200	110	280	1/2"	20,4
558 0481	POST EC 250-7700	345	280	250	110	280	1/2"	24,5
558 0482	POST EC 315-12500	420	355	315	110	280	1/2"	31,5

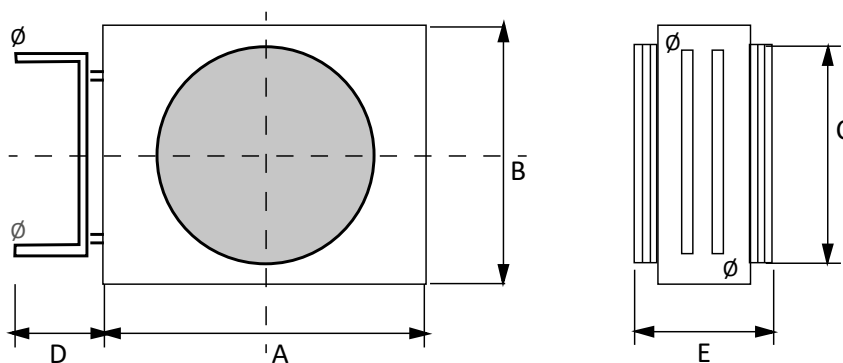

Code	Model	Connection Ø [mm]	Air power [m³/h]	Pressure drop [Pa]	Power [W]	Water flow rate [l/h]	Water pressure drop [kPa]
558 0478	POST EC 125-2600	125	350	42	2600	108	0,5
558 0479	POST EC 160-3600	160	454	42	3600	144	1
558 0480	POST EC 200-4800	200	571	44	4800	216	1,6
558 0481	POST EC 250-7700	250	846	42	7700	324	4,7
558 0482	POST EC 315-12500	315	1361	44	12500	540	5,7



PRODUCT RANGE

NEW



5509EF

Insulated cold water batteries for heating and cooling, circular connection section.

Terminal battery ideal for post cooling in combination with ventilation units for residential installations

ADVANTAGES/STRENGTH

- Regulation by means of 2-way valve
- Terminal heating battery
- Stainless steel condensate collection basin (galvanized inclined plane)

STRUCTURE

Steel case with rock wool insulation ($\lambda = 0.035 \text{ W/m.k}$), galvanized steel round fittings, aluminium fin cold water battery and copper pipes and steel manifolds, inclined condensate collection basin in galvanized steel and condensate fittings made of stainless steel

ACCESSORIES

Motorized valves for regulating the flow rate to the internal battery, actuators with 230 V and 24 V power supply

Code	Model	Price €	Unit/Box
558 0473	POST EF 125-2000		1/1
558 0474	POST EF 160-3400		1/1
558 0475	POST EF 200-5100		1/1
558 0476	POST EF 250-7300		1/1
558 0477	POST EF 315-13200		1/1

Model indications for connection and power:
POST EF DN (mm) – Power (W)

DIMENSIONAL AND TECHNICAL CHARACTERISTICS

Code	Model	L [mm]	H [mm]	A [mm]	B [mm]	C [mm]	Battery conn. [Ø]	Insulating thick. [mm]
558 0473	POST EF 125-2000	150	150	272	202	505	1/2"	10
558 0474	POST EF 160-3400	200	200	322	252	505	1/2"	10
558 0475	POST EF 200-5100	250	250	372	302	505	1/2"	10
558 0476	POST EF 250-7300	300	300	422	362	505	1/2"	10
558 0477	POST EF 315-13200	400	400	522	452	505	3/4"	10

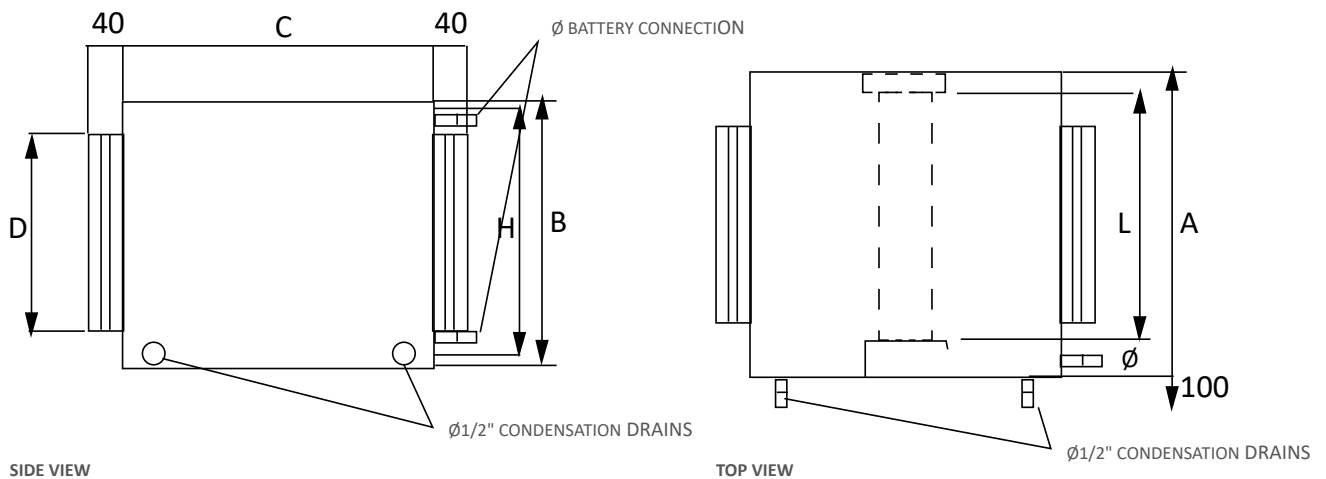

Code	Model	Connection Ø [mm]	Air power [m³/h]	Pressure drop [Pa]	Power [W]	Water flow rate [l/h]	Water pressure drop [kPa]
558 0473	POST EF 125-2000	125	243	115	2010	344	57,9
558 0474	POST EF 160-3400	160	432	121	3420	587	32,3
558 0475	POST EF 200-5100	200	600	103	5170	887	31,1
558 0476	POST EF 250-7300	250	972	130	7320	1268	35,9
558 0477	POST EF 315-13200	315	1728	135	13230	2271	48,1



9683CU

Remote control panel with temperature and humidity probes, speed, temperature, and operating modes control. 503 box mounting or wall mounting, maximum connection length 50 mt if made with shielded braided cable with 4 wires

Code	Colour	Price €	Unit/Box
957 0213	Wi-Fi ■ Black		1/1
957 0212	Wi-Fi □ White		1/1

NEW



5508COM

Remote panel with Wi-Fi functions and control from APP, for temperature, speed, and operating modes control. 503 box mounting or wall mounting, maximum connection length 50 mt if made with shielded braided cable with 4 wires

Code	Colour	Price €	Unit/Box
957 0218	Wi-Fi ■ Black		1/1
957 0217	Wi-Fi □ White		1/1

NEW



5507COM

LCD display regulation and control panel with integrated humidity and ambient temperature probes, allowing complete management of the unit and any accessories

Code	Colour	Price €	Unit/Box
957 0219	LCD □ White		1/1

NEW



5514

Modbus RS485 wall-mounted chronothermostats with backlit LCD panel, against up to 30 units, temperature selection, operation mode, speed of ventilation, manual/ chronothermostatic mode, ambient probe inserted in the control. Equipped with presence sensor contact, 230V/12 VAC dual insulation power supply transformer and backup battery. Wall mounting with centre distance compatible with the 503 standard box

Code	Colour	Price €	Unit/Box
957 0229	LCD □ White		1/1



5602CON

Remote control panel with graphical interface and various unit control functions. Mounting in support on horizontal 503 box or wall, maximum connection lengths; 15 meters power supply from the unit, 50 meters with external power 12 Vac

Code	Colour	Price €	Unit/Box
558 0427	Mod-Bus □ White		1/1



5530V

CLIMAV 6000 resistive touchscreen viewer connected to the master unit (MHC or MHC BASIC) allows the user complete control of the entire thermoregulation system. Display format 16:9 by 4.3" CLIMAV 6000W is equipped with an internal clock and a mini-USB port for software updates. Available in white or black

Code	Colour	Price €	Unit/Box
555 0101	Wi-Fi □ White		1/1
555 0336	Wi-Fi ■ Black		1/1

NEW



5530W

CLIMAV 6000W capacitive touchscreen viewer connected to the MHCW master unit allows the user complete control of the entire thermoregulation system. Display format 16:9 by 4.3" CLIMAV 6000 is equipped with an internal clock and a mini-USB port for software updates. Available in white

Code	Colour	Price €	Unit/Box
555 0353	Wi-Fi □ White		1/1



COMBINATION OF VENTILATING UNITS WITH REMOTE CONTROLS

DEHUMIDIFIERS	PUNCTUAL CMV	RESIDENTIAL CMV	TERTIARY CMV	DEHUMIDIFIERS + HYDRONICS CMV	DEHUMIDIFIERS + COOLING CIRCUIT CMV	FAN COIL UNITS
 5600GH 5600GHWZ	 5506XL	 5504O 5507	 5512O	 5508O	 5602GHWZ	 5603FAN 5608FAN
 5600FH1 5600FHWZ1		 5504O1	 5512V	 5508V	 5502GHWZV	 5607FAN
 5600FH 5600FHWZ		 5504V				 5604FAN
 5600FHDWZ						

9683CU	957 0213 ¹	●						
	957 0212 ¹	●						
5508COM	957 0218 ²		●	●		●		●
	957 0217 ²		●	●		●		●
5507COM	957 0219			●	●			
5602CON	558 0427					●		
5514	957 0229							●
5530V	555 0101	●	●	●	●		●	●
	555 0336							
5530W	555 0353	●	●	●	●		●	●

Single CMV and Dehumidifier controls

¹ Control with humidity probe to detect the internal relative humidity value

² Control with IAQ sensor for humidity and air quality



5503TUB

ISO-FLEX-H Self-extinguishing insulated flexible pipe made of silver ion treated aluminium with antimicrobial and anti-mould action. Reaction to fire class M0/M1

Code	Type	Price €/m	Unit/Box (m)
556 0284	Ø 100		10/10
556 0285	Ø 125		10/10
556 0286	Ø 160		10/10
556 0287	Ø 200		10/10
556 0288	Ø 250		10/10
556 0289	Ø 315		10/10



5503FAS

Stainless steel clip for flexible pipe connection

Code	Type	Price €	Unit/Box
556 0383	Ø 145		1/1
556 0384	Ø 215		1/1
556 0385	Ø 380		1/1



5503TCOMPU

COMFOFORM PURO Antistatic circular flexible pipe with antibacterial treatment for floor, suspended ceilings and walls distribution system, highly flexible, double-layer, externally corrugated and smooth inside, completely made of PE

Code	Type	Price €/m	Unit/Box (m)
556 0309	Ø 75		50/50
556 0310	Ø 90		50/50



5503BOB

COMFOFORM ISO Insulating coil for COMFOFORM circular pipe

Code	Type	Price €/m	Unit/Box (m)
556 0311	Ø 75		15/15
556 0312	Ø 90		15/15



5503GIU

Connection joint for COMFOFORM pipe

Code	Type	Price €	Unit/Box
556 0314	Ø 75		1/1
556 0315	Ø 90		1/1



5503OR

O-ring seal to be used for all seals between COMFOFORM pipe, fittings and diffusers

Code	Type	Price €	Unit/Box
556 0299	Ø 75		10/10
556 0300	Ø 90		10/10



5503RCOL

Combo manifold fitting for COMFOFORM pipe

Code	Type	Price €	Unit/Box
556 0295	Ø 75		1/1
556 0296	Ø 90		1/1



5503TAP

Blind plug for COMFOFORM pipe

Code	Type	Price €	Unit/Box
556 0302	Ø 75		5/5
556 0303	Ø 90		5/5



5503CUR

90° bend for COMFOFORM pipe

Code	Type	Price €	Unit/Box
556 0316	90° - Ø 75		1/1
556 0317	90° - Ø 90		1/1





5503REG

RAD 2 Adjustable constant flow air regulator for project flow rate maintenance

Code	Type	Price €	Unit/Box
556 0369	Ø 80/15-50 m³/h		1/1
556 0370	Ø 100/15-50 m³/h		1/1
556 0371	Ø 100/50-100 m³/h		1/1
556 0372	Ø 125/15-50 m³/h		1/1
556 0373	Ø 125/50-100 m³/h		1/1
556 0374	Ø 160/15-50 m³/h		1/1
556 0375	Ø 160/50-100 m³/h		1/1
556 0376	Ø 160/100-180 m³/h		1/1
556 0377	Ø 160/180-300 m³/h		1/1
556 0378	Ø 200/15-50 m³/h		1/1
556 0379	Ø 200/50-100 m³/h		1/1
556 0380	Ø 200/100-180 m³/h		1/1
556 0381	Ø 200/180-300 m³/h		1/1
556 0382	Ø 200/300-500 m³/h		1/1



5503TSLPU

COMFOSLIM PURO Low-form flexible pipe resistant to crushing with antistatic treatment and antibacterial for floor, false ceiling and walls distribution system. Made double-layer, externally corrugated and smooth inside completely in PE. Unique exclusive connection joint to seal Easily connect the pipe to all fittings. In addition, the coupling can be fixed through the appropriate fixing rings

Code	Type	Price €	Unit/Box (m)
556 0331	132 x 52 mm		20/ 20
556 0332	132 x 52 mm		3 m x 12 pz = 36

Pipe in bars of 3 meters, pack of 12 bars (36 meters).



5503RAC

Straight connection for COMFOSLIM pipe and COMFOFORM circular pipe

Code	Type	Price €	Unit/Box
556 0341	Ø 75 - 132 x 52 mm		1/1
556 0342	Ø 90 - 132 x 52 mm		1/1



5503BOBSL

COMFOSLIM ISO Insulating coil for COMFOSLIM oval pipe

Code	Type	Price €/m	Unit/Box (m)
556 0334	132 x 52 mm		10/10



5503RCOLP

ComboSlim manifold fitting for COMFOSLIM pipe

Code	Type	Price €	Unit/Box
556 0297	132 x 52 mm		1/1



5503GIUSL

Connection joint with double O-ring seal for COMFOSLIM pipe

Code	Type	Price €	Unit/Box
556 0335	132 x 52 mm		1/1



5503TAPSL

Blind plug for COMFOSLIM pipe.

Code	Type	Price €	Unit/Box
556 0336	132 x 52 mm		1/1



5503RCOLSL

Combo manifold fitting with COMFOSLIM pipe

Code	Type	Price €	Unit/Box
556 0333	Ø 90 - 132 x 52 mm		1/1



5503ROVSL

180° inverted connection to be used, if necessary, to invert the flat side of the COMFOSLIM pipe in wall climbs and connect them to the nozzle

Code	Type	Price €	Unit/Box
556 0339	180° - 132 x 52 mm / 52 x 132 mm		1/1



5503CURVSL

Vertical 90° bend for COMFOSLIM pipe

Code	Type	Price €	Unit/Box
556 0337	90° Vert. - 132 x 52 mm		1/1



5503CUROSL

Horizontal 90° bend

Code	Type	Price €	Unit/Box
556 0338	90° Horiz. - 132 x 52 mm		1/1





5503COL

COMBO 2-4 Silenced distribution manifold with 2-4 configurable outputs

DESCRIPTION

- 1 Ø 160 mm connection in input
- 4 predispositions for Ø 75/90 mm connections in output

Code	Dimensions	Price €	Unit/Box
556 0290	300 x 200 x 150 mm		1/1



5503COLP

COMBO 2-6 Silenced distribution manifold with 2-6 configurable outputs

DESCRIPTION

- 1 Ø 160 mm connection mm in input
- 6 predispositions for Ø 75/90 mm connections in output+ panel with 3 Ø 75/90 mm connections and 2 connections lowered 132 x 52 mm

Code	Dimensions	Price €	Unit/Box
556 0293	370 x 240 x 240 mm		1/1



5503COLT

COMBO 2-10 Silenced distribution manifold with 2-10 configurable outputs

DESCRIPTION

- 1 Ø 200 mm connection in input,
- 10 predispositions for Ø 75/90 mm connections in output+ panel with 4 Ø 75/90 mm connections and 4 connections lowered 132 x 52 mm

Code	Dimensions	Price €	Unit/Box
556 0291	580 x 240 x 240 mm		1/1



5503SIL

SC VMC Circular silencer with galvanized steel outer casing, sound insulation, 45 to 65 mm thick, coated with perforated sheet metal

Code	Type	Price €	Unit/Box
556 0353	Ø 125 L=600 mm		1/1
556 0354	Ø 160 L=600 mm		1/1
556 0355	Ø 200 L=600 mm		1/1
556 0356	Ø 250 L=600 mm		1/1
556 0357	Ø 125 L=900 mm		1/1
556 0358	Ø 160 L=900 mm		1/1
556 0359	Ø 200 L=900 mm		1/1
556 0360	Ø 250 L=900 mm		1/1



5503GPT

PURA TONDA External air intake/exhaust grille complete with connection reduction of galvanized sheet

Code	Type	Price €	Unit/Box
556 0350	Ø 160 - Ø 125		1/1
556 0351	Ø 200 - Ø 160		1/1
556 0352	Ø 250 - Ø 200		1/1

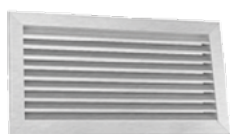

5503GRIAIR

AIR PURA Grille with fixed fins made in natural anodized aluminium with mesh, paintable on request

Code	Type	Price €	Unit/Box
556 0344	300 x 150 mm		1/1
556 0345	400 x 200 mm		1/1
556 0346	500 x 300 mm		1/1

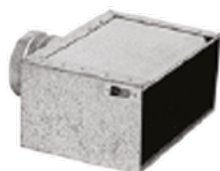

5503PLE

PGS20 Plenum in galvanized sheet for PURA grille with circular rear connection

Code	Type	Price €	Unit/Box
556 0347	300 x 150 mm/ Ø 148		1/1
556 0348	400 x 200 mm/ Ø 198		1/1
556 0349	500 x 300 mm/ Ø 248		1/1



5503BOC

PG Built-in grille holder nozzle, designed for filter, for ceiling, wall and false ceiling installation.

MODELLI

- **PG1 MC:** Single side connection on short side Ø 75/90 mm (236 x 135 x 115)
- **PG1 P-L:** Single rear connection Ø 75/90 mm Single side connection on long side Ø 75 mm (236 x 135 x 90)
- **PG1 L90:** Single side connection on long side Ø 90 mm (236 x 135 x 115)
- **PG2 P-L:** Double rear connection Ø 75/90 mm Double side connection on the long side Ø 75 mm (410 x 135 x 90)
- **PG2 L90:** Double side connection on the long side Ø 90 mm (410 x 135 x 115)
- **PG3 P-L:** Single rear and side low connection 132 x 52
- **PG4 P-L:** Double rear connection and side low connection 132 x 52

i To be combined with grille art. 5503GRI and filter art. 5503FIL

Code	Model	Price €	Unit/Box
556 0318	PG1 MC		1/1
556 0319	PG1 P-L		1/1
556 0320	PG1 L90		1/1
556 0323	PG2 P-L		1/1
556 0325	PG2 L90		1/1
556 0321	PG3 P-L		1/1
556 0324	PG4 P-L		1/1



5503GRI

TAMIGI Grille in white painted steel with hole for PG built-in nozzle

i To be combined with grille holder art. 5503BOC and filter art. 5503FIL

Code	Grille holder pair	Price €	Unit/Box
556 0327	PG1 MC		1/1
556 0326	PG1 P L / PG1 L90 / PG3 P-L		1/1
556 0328	PG2 P L / PG2 L90 / PG4 P-L		1/1



5503FIL

Filter for PG built-in nozzle

i To be combined grille grid holder art. 5503BOC and grille art. 5503GRI

Code	Grille holder pair	Price €	Unit/Box
556 0329	PG1 MC / PG1 P-L / PG1 L90 / PG3 P-L		5/5
556 0330	PG2 P-L / PG2 L90 / PG4 P-L		5/5





5503GRI1

LAC23 Linear diffuser with 28 mm slits, for air inlet or intake in environment. RAL 9016 finish.

Code	Dimensions	Price €	Unit/Box
556 0400	Lunghezza 500 mm		1/1
556 0450	Lunghezza 800 mm		1/1
556 0399	Lunghezza 1000 mm		1/1



5503BOC1

LAC23-P Grille holder nozzle for built-in diffuser with 28 mm slits, with upper and side pre-cut connections, for \varnothing 75/90 mm conduit and for \varnothing 125 mm conduit.

Code	Dimensions	Price €	Unit/Box
556 0398	L = 500 mm – 1 x \varnothing 75/ \varnothing 90 mm		1/1
556 0451	L = 800 mm – 2 x \varnothing 75/ \varnothing 90 mm		1/1
556 0397	L = 1000 mm – 3 x \varnothing 75/ \varnothing 90 mm		1/1
556 0452	L = 500 mm – 1 x \varnothing 125 mm		1/1
556 0453	L = 800 mm – 2 x \varnothing 125 mm		1/1
556 0454	L = 1000 mm – 3 x \varnothing 125 mm		1/1



5503BOC1R

De 123 mm metal fitting for connection to flexible conduit, fixing with metal clamp. In combination with plenum 5503BOC1 connection 125 mm (fixing by screws).

Code	Dimensions	Price €	Unit/Box
556 0455	Metal fitting De 123 mm		1/1



5503DIFR

AERYS Delivery/ return diffuser with RAD self-adjusting flow regulator

Code	Type	Price €	Unit/Box
556 0366	\varnothing 125		1/1
556 0393	\varnothing 160		1/1
556 0394	\varnothing 200		1/1



5503DIF

BOREA Delivery / return circular diffuser

Code	Type	Price €	Unit/Box
556 0367	\varnothing 80		1/1
556 0368	\varnothing 125		1/1



5503VAL

Delivery/extraction valve for small air flows rates with adjustable central disc, made of plastic, resistant to aggressive environments, complete with fixing straight nipple

Code	Type	Price €	Unit/Box
556 0361	\varnothing 100 + Straight nipple		1/1
556 0362	\varnothing 125 + Straight nipple		1/1
556 0363	\varnothing 160 + Straight nipple		1/1
556 0364	\varnothing 200 + Straight nipple		1/1



PRODUCTS QUALITY

TIEMME RACCORDERIE S.p.A.
manufacturer of complete heating, sanitary and gas systems
situated in Castegnato (Brescia) Via Cavallera, 6/A
as per Ministerial Decree 37/08 "Plants Installation"
and as per 10/91 law

DECLARES

that all the products distributed to the customers
are designed and manufactured in compliance with technical regulation
and quality criteria required by International Standards EN ISO 9000.

The quality of TIEMME products
has been awarded with ISO 9001 certification
acknowledging the Company's commitment
to the development, production and marketing
of its goods.

The Legal Representative

FACSIMILE COPY

The original document and the entire text of the above-mentioned regulations are stored in the legal office of
TIEMME RACCORDERIE S.p.A. Via Cavallera 6/A - 25045 - Castegnato (Bs)

The products manufactured by Tiemme Raccorderie S.p.A. (hereinafter referred to as "Company") are guaranteed for 2 years from the date of shipment from its premises. This warranty is additional to and does not affect the buyer's rights under the European Directive 99/44/CE and its national implementing decree, except where otherwise specified.

This warranty does not cover the failure or damage caused by:

- Transport not carried out by the Company.
- No compliance with instructions and warnings provided by the manufacturer and reported on manuals, and instructions and/or product catalogues.
- No compliance with law and/or regulations.
- Absence or lack of maintenance, neglect, inability to use, tampering.
- Improper installation and/or anomalies of any nature in the supply of hydraulic, electrical, fuel delivery and/or exhaust systems.
- Inadequate water treatments, disinfecting treatments improperly carried out.
- Corrosion due to the aggressive nature of water or condensation.
- Frost, stray currents, and/or harmful effects of lightning and storms.
- Preventive replacements.
- Causes of force majeure beyond the control of the manufacturing Company.

Any defect in materials or hidden faults as well as mistakes or differences in dimensions exceeding normal manufacturing tolerances will commit the Company to the replacement of defective parts only.

Any return of non-conforming goods will be accepted only with prior written authorization ("Return Authorization") by the Company's Sale Manager.

In any case the returned goods shall have to reach the Company's warehouse freight paid, otherwise the goods will be rejected and returned to the sender.

Any return of non-compliant material must be agreed in advance with the Company's Sale Director. Transport costs will be borne by the customer.

The insurance cover has the duration of 10 years from the date of shipment from the Company's premises, as contemplated in the Decree 24-05-1988 n°224.

Only in the case of the implementation of non-conforming products manufactured by the Company and as a result, accidental damages to person or things, the Company will require their insurance agency to proceed according to its policy. The claim has to be placed within 10 days of the event, otherwise a non-compensation penalty will apply. A specific questionnaire including all the accident details, relevant documentation, and samples of the faulty articles which are necessary to complete the compensation file must be duly filled within 30 days. No refund will be granted before the Company has verified the causes of the complaint.

Should laboratory tests be necessary, the costs incurred whilst checking and defining the non-conformity of a claim or return or damage will be charged to the customer if the fault cannot be attributed to the Company.

Installers are to carry out and document plant tests in compliance with international regulations in force in Italy as prescribed by the Ministerial Decree 37/08 and UNI 9182 standards.

ORDERS

All orders are placed as reservation and do not bind our Company to delivery, not even partially. Orders will be accepted and despatched only if in an amount exceeding 700 €.

PRICES

Unless otherwise agreed in writing the prices in force at the time of delivery or shipment shall apply.

Prices are meant for goods delivered EX WORKS.

SHIPMENTS

Goods are usually shipped freight collect, unless otherwise agreed. Goods travel at buyer's risk even if sold free of carriage .

PAYMENTS

Payment conditions are those stated in the invoice and are binding. Upon the expiration date of agreed deadlines, without any notice, interests on arrears calculated according to the average bank rate applied to the date of expiry shall be counted.

Any draft or payment fees will be at full client's charge.

CLAIMS

No claim will be accepted after 5 days upon goods receipt. Claims shall be submitted in writing and addressed to our headquarters.

RETURNED GOODS

No returned goods will be accepted without our previous authorization. The authorization must be issued in writing and goods are, in any case, returned carriage paid.

SUSPENDED ORDERS AND FORCE MAJEURE

If the buyer does not comply, even partially with our terms of sale, our company can suspend further deliveries.

Our company is exempt from any obligation arising from the sale agreement in case of force majeure.

CHANGES

Our company reserves the right to make, without notice, any changes that are technically necessary at any time and for any reason.

Images included in this catalogue are shown for information purposes only and they do not bind the Company which reserves the right to make changes without prior notification.

COURT OF JURISDICTION

In the event of a dispute, the competent authority is the Court of Brescia.

INTEGRATED COMPONENTS AND SYSTEMS FOR PLUMBING PLANTS



HYDRO COMPONENTS



CENTRAL HEATING - METERING



RADIANT SYSTEMS



FAUCETS

TIEMME

TIEMME

TIEMME



TIEMME RACCORDERIE S.p.A.
Via Cavallera, n. 6/A- 25045 Castegnato (BS)- Italy
Tel. +39 030 2142211
info@tiemme.com

customerservice@tiemme.com

www.tiemme.com



TIEMME