

*Zgjidhje moderne të
ngrohjes dhe të
furnizimit me ujë
për hotele*

**SISTEME MODERNE TË NGROHJES DHE TË
FURNIZIMIT ME UJË**

Përmbajtja

Zgjidhje moderne të ngrohjes dhe të furnizimit me ujë për hotele

1.	<u>Zgjidhje për instalime sanitare</u>	4
1.1.	<u>“SANIBOX” Kutë me kolektor të paramontuar</u>	4
1.2.	<u>Kolektor shpërndarjeje "MAXIMA"</u>	8
1.3.	<u>Komponentët e rrjetit të furnizimit me ujë</u>	9
1.4.	<u>LEGIO TIEMME – Sistemi Dezinfektimit Termik kundër Legjionelës</u>	11
2.	<u>Zgjidhje për sisteme termike</u>	12
2.1.	<u>Komponentët e kontrollit të rrjedhës</u>	12
2.2.	<u>Tiemme Box</u>	16
2.3.	<u>Sistemi Tiemme SLIM</u>	18
3.	<u>Rubinetat</u>	19
3.1.	<u>Rubinet inkaso për lavaman</u>	20
3.2.	<u>Koleksioni SKY T30</u>	21
3.3.	<u>Koka Dushi</u>	25
3.4.	<u>Rubinet me ndërprerje</u>	26
4.	<u>Instalime BIM</u>	28



Katalogu është interactive



1. Zgjidhje për instalime sanitare

1.1. "SANIBOX" Kuti me kolektor të paramontuar



Kodi	Përmasat	Çmimi	Sasia
304 0152	295 x 226 x 77		1/1



3 furnizime për ujë të ftohtë dhe 3 furnizime për ujë të ngrohtë në të njëjtën anë.

Kolektor të paramontuar

Sanibox

Art. 3023

Kolektorë të kromuar SANIBOX, të montuar në një kuti me çelës qendror, tapa dhe mbulesa dekorative me guarnicion

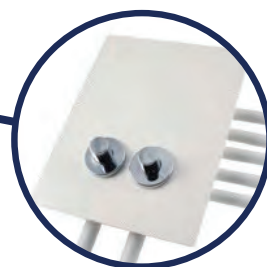
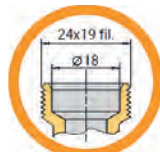

Sharkoni

Fletën Teknike



Ndërtim i standardizuar dhe për banjot e hoteleve ose për ndërtesa kolektive

Instalime

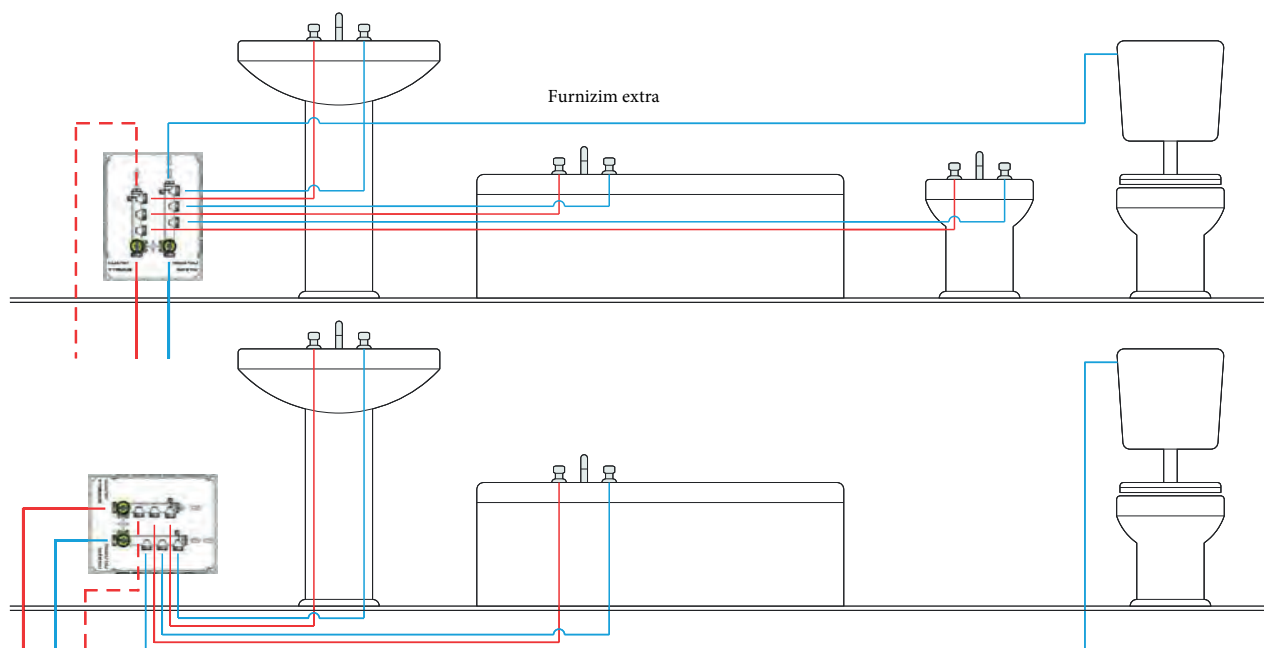



Kodi	Përmasat	Çmimi	Sasia
304 0007	295 x 226 x 77		1/1

i 6 furnizime për ujë të ftohtë dhe 4 furnizime për ujë të ngrohtë në të njëjtën anë.

i Përfshihen 3 tapa

Kolektor të paramontuar

Sanibox

Art. 3033
Kolektorë të kromuar SANIBOX, të montuar në një kuti me çelës qendror, tapa dhe mbulesa dekorative me guarnicion

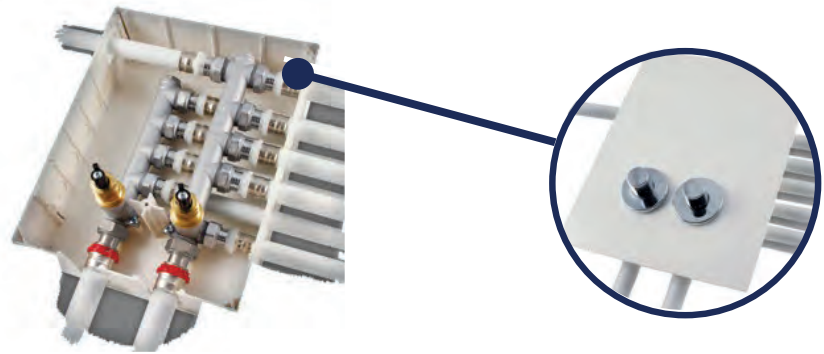
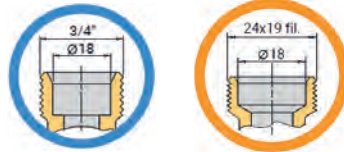

Sharkoni
Fletën Teknike



Instalime

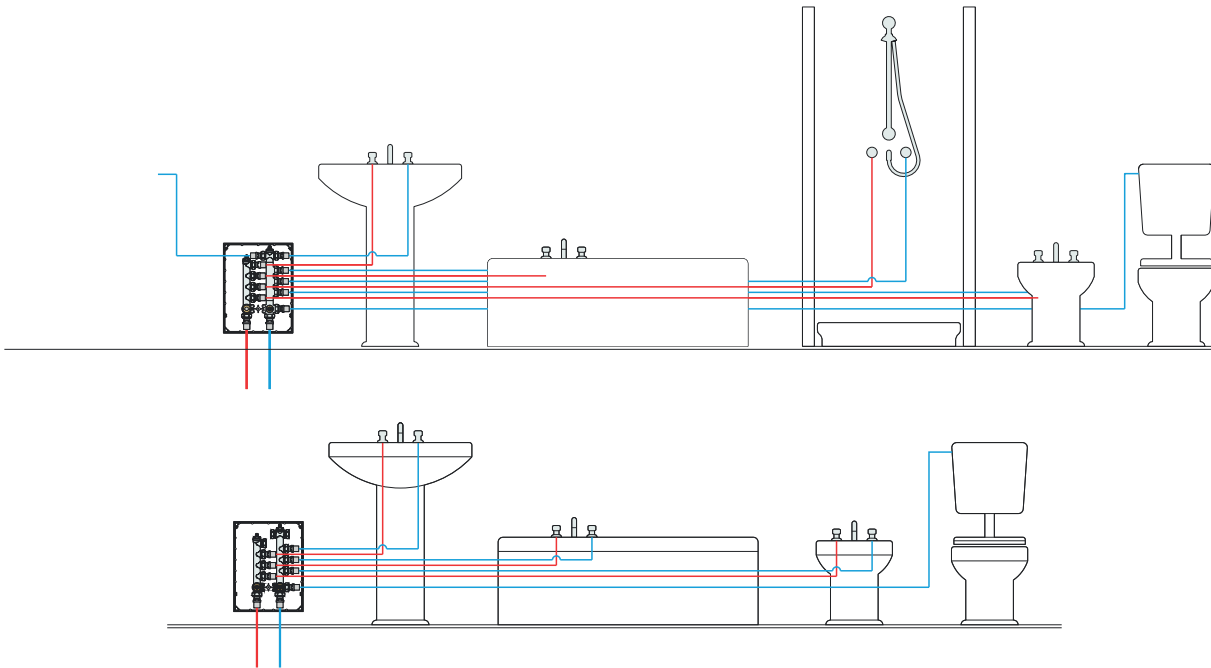



Kodi	Përmasat	Çmimi	Sasia.
304 0008	295 x 226 x 77		1/1

i 6 furnizime për ujë të ftohtë dhe 4 furnizime për ujë të ngrohtë në anë të kundërta.

i Përfshihen 3 tapa

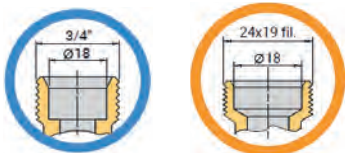

Kolektor të paramontuar

Sanibox

Art. 3035

Kolektorë të kromuar SANIBOX, të montuar në një kuti me çelës qendror, tapa dhe mbulesa dekorative me garnicion

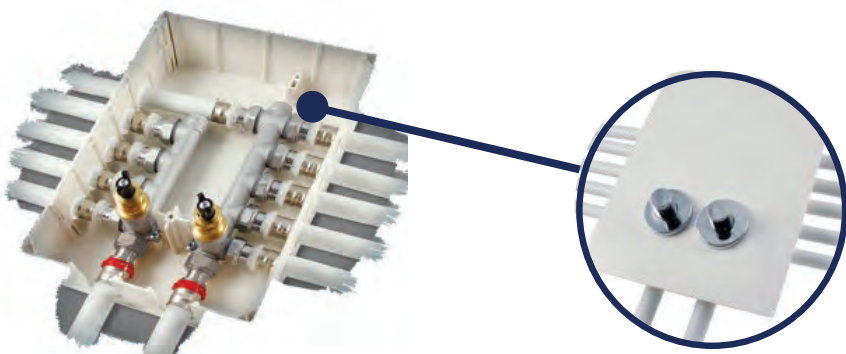

Sharkoni
FletënTeknike

Instalime

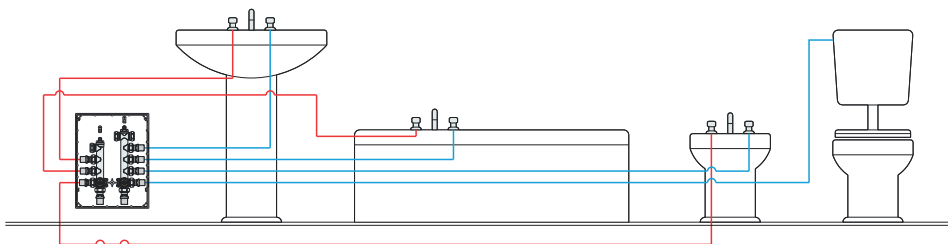
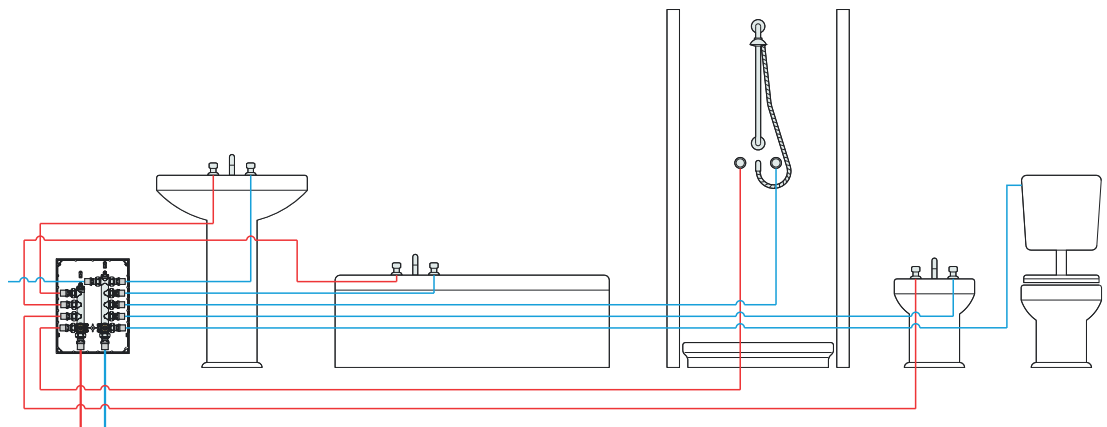

Udhëzime për instalimin



Udhëzime për lidhjet

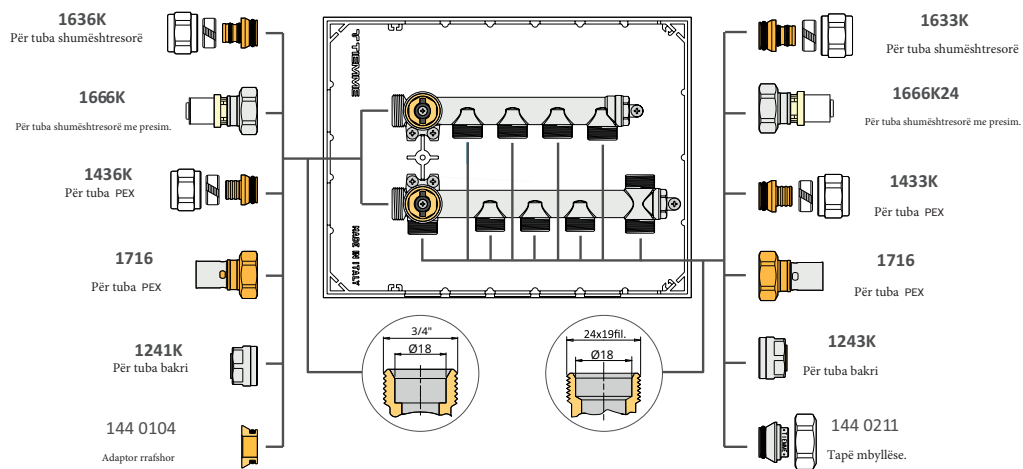

1.2. Kolektor shpërndarjeje "MAXIMA"

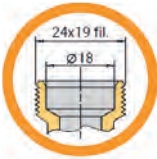

Kolektor Maxima

Art. 1877K36

Kolektorë MAXIMA me koka vidhosje për ndërprerje, të prodhuara prej CW617N të kromuar me kanale 24x19fil Ø18. Distanca mes qendrave 36 mm. Filetim vetëizolues me unazë-o.

Kodi	Përmasat	Dalje	Dimnsione të daljes	Çmimi	Sasia.
186 0023	3/4"G	2	24x19 18		1/25
186 0018	3/4"G	3	24x19 18		1/25
186 0014	3/4"G	4	24x19 18		1/25
186 0016	3/4"G	5	24x19 18		1/20
186 0085	3/4"G	6	24x19 18		1/15

Sharkoni
FletënTeknike



Valvul sferike

Art. 2121

Valvul sferike ISO228 me levë fluture të kuqë ose të kaltër dhe bashkim me unazë-O, holander.



Tap femër për kolektorë

Art. 1880K

Tapë femër e kromuar

Kodi	Përmasat	Çmimi	Sasia.
212 0001	3/4"		10/40

Kodi	Përmasat	Çmimi	Sasia.
150 0752	3/4"		10/100



Kuti UNIVERSAL

Art. 1812

Kodi	Përmasat	Çmimi	Sasia.
181 0129	310x295x80		1/5
181 0130	420x295x80		1/5
1810131	510x295x80		1/5
181 0181	620x295x80		1/5

1.3. Komponentët e rrjetit të furnizimit me ujë



Rregullatori termostatik

Art. 4733

Rregullatori shumëfunksional termostatik për qarqet ose ciklet e qarkullimit të ujit te nxehte

Kodi	Përmasat	Çmimi	Sasia.
473 0005	1/2"		1/10
473 0006	3/4"		1/6



rezistente ndaj anti-dezincifikimit



Rregullatori termostatik

Art. 4734

Rregullatori shumëfunksional termostatik për qarqet ose ciklet e qarkullimit të ujit te nxehte me dezinfektimin termik të kontrolluar nga një aktivizues

Kodi	Përmasat	Çmimi	Sasia.
473 0007	1/2"		1/8
473 0008	3/4"		1/8



rezistente ndaj anti-dezincifikimit

Sharkoni
Fletën Teknike



Brryl femër i dyfishtë

Art. 1676USM

Brryl femër e dyfishtë me formë U, me presim

Kodi	Përmasat	Lartësi	Çmimi	Sasia.
165 1315	16 x 1/2" x 16	40 mm		10/50
165 1317	20 x 1/2" x 20	40 mm		5/50



Lejon trajtimin efektiv të bakterit legionella

Kodi 1676USMSN



Kodi	Përmasat	Çmimi	Sasia.
165 1399	16 x 1/2" x 16		10/50
165 1400	20 x 1/2" x 20		5/50



Bryll mashkull i dyfishtë

Art. 1654U

Bryll mashkull i dyfishtë.

Sharkoni

FletënTeknike



Lejon trajtimin efektiv të bakterit legionella

Kodi 1676USN)



Kodi	Përmasat	Çmimi	Sasia.
165 1404	16 x 1/2" x 16		5/50
165 1405	20 x 1/2" x 20		5/50



Valvul sferike

Art. 2230V

Valvul sferike URAGANO femër/femër ISO7/EN 10226 me dorezë të sheshtë të plastifikuar me ngjyrë të jeshile

Kodi	Përmasat	Çmimi	Sasia.
220 0125	1/4"		25/100
220 0126	3/8"		25/100
220 0127	1/2"		15/60
220 0128	3/4"		10/40
220 0129	1"		8/32
220 0130	1"1/4		4/16
220 0131	1"1/2		3/12
220 0132	2"		2/8

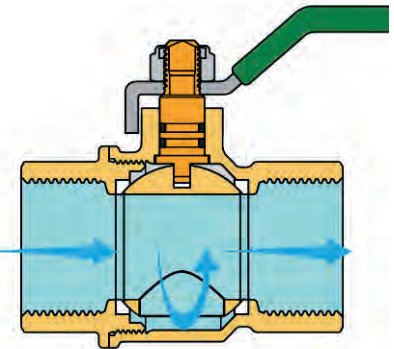

Lejon trajtimin efektiv të bakterit legionella

Sharkoni

FletënTeknike



Amortizator i luhatjes së befashme të shtypjes së ujit

Art. 1935

Amortizator i luhatjes së befashme të shtypjes së ujit

- Trupi: bronzi CW617 krom i veshur
- Polimeri me forcë të lartë: EPDM
- Susta : çelik inox
- Hidroizolim: EPDM
- Lëng i përshtatshëm: Ujë
- Presioni maksimal funksioni: 10 bar
- Temperatura maksimale : 110°C
- Qëndrueshmëri në luhatje të befashme deri ne 50 bar.
- Fillimi i funksionimit: 3 bar Lidhjet: 1/2" me unazën hidroizolimi EPDM



Kodi	Përmasat	Çmimi	Sasia.
194 0001	1/2"		1/25



Sharkoni

FletënTeknike

1.4. LEGIO TIEMME - Sistemi Dezinfektimit Termik kundër Legionelës



LEGIO-TIEMME mikser

kit

Art. 4723KIT

Set i përzierjes LEGIO - TIEMME i kompletuar me lidhëse holander si dhe mbajtës sonde.

Kodi	Përmasat	Çmimi	Sasia.
320 0022	1"1/4		1/5
320 0023	1"1/2		1/5

Sharkoni

FletënTeknike



Drejtues termik

Art. 9562P1

0÷10V komandues termik për valvula përzierëse me 3 kalime

Kodi	Modeli	Çmimi	Sasia.
450 0652	0-10V - 24 Vac		1/10

Sondë temperature

Art. 5530P

Sondë temperature NTC 10K@25°C me diametër 6mm



Kodi	Përmasat	Çmimi	Sasia.
555 0149	-		1/10



4723CENTR

NJËSIA e kontrollit

LEGIOTIEMME për menaxhimin e sistemit sanitar dhe trajtimin Anti-legionella

Kodi	Përmasat	Çmimi	Sasia.
320 0024	-		1/4

2. Zgjidhje për sisteme termike

2.1. Komponentët e kontrollit të rrjedhës



Valvulë balancuese me kontroll presioni.

Art. 6538

Valvulë balancuese me kontroll presioni

Kodi	Përmasat	DN	ΔP	Shkalla l/h	Çmimi	Sasia.
651 0626	1/2" (DN15)	DN20	5 - 50 kPa	15 - 2000		1/10
651 0627	3/4" (DN20)	DN20	5 - 50 kPa	15 - 2000		1/10
651 0628	1" (DN25 e vogël)	DN20	5 - 50 kPa	15 - 2000		1/10
651 0898	1" (DN25 e madhe)	DN40	5 - 60 kPa	15 - 5980		1/10

Sharkoni
FletënTeknike



Valvulë balancuese me kontroll presioni.

Art. 6540

Valvulë balancuese me kontroll presioni me çelës. Mundësi për vendosje të motorit ON/OFF

Kodi	Përmasat	ΔP	Shkalla l/h	Çmimi	Sasia.
651 0920	1/2"	3 - 17 kPa	9 - 680		1/10
651 0921	3/4"	3 - 17 kPa	9 - 680		1/10
651 0922	1"	3 - 17 kPa	9 - 680		1/10

Sharkoni
FletënTeknike



Valvulë balancuese AUTO

Art. 6542CCS

Valvula balancuese dinamike TM AUTO F/F me rregullator të jashtëm të përgatitur për servomotor.

Kodi	Përmasat	DN	ΔP	Χρώμα	Shkalla l/h	Çmimi	Sasia.
651 0808	1/2" (DN15)	DN20	16 - 200 kPa	Gjelbër 0	37 - 575		1/10
651 0809		DN20	30 - 800 kPa	Gjelbër 1	64 - 1110		1/10
651 0810	3/4" (DN20)	DN20	16 - 200 kPa	Gjelbër 0	37 - 575		1/10
651 0811		DN20	30 - 800 kPa	Gjelbër 1	64 - 1110		1/10
651 0812	1" (DN25 e vogël)	DN20	16 - 200 kPa	Gjelbër 0	37 - 575		1/10
651 0813		DN20	30 - 800 kPa	Gjelbër 1	64 - 1110		1/10
651 0820	1" (DN25 e madhe)	DN40	16 - 800 kPa	Gjelbër 2	865 - 4630		1/10

Sharkoni
FletënTeknike





Valvulë balancuese

Art. 6542CC

Valvula balancuese dinamike TM-EASY F/F me rregullator të jashtëm dhe lidhje për valvulen e presionit.

Sharkoni

Fletën Teknike



Kodi	Përmasat	Përmasat	ΔP	Shkalla l/h	Çmimi	Sasia.
651 0786			17 - 210 kPa	E zezë 100 - 412		1/10
651 0787			17 - 210 kPa	Gjelbër 157 - 609		1/10
651 0788			35 - 400 kPa	E zezë 138 - 615		1/10
651 0789	1/2" (DN15)	DN20	35 - 400 kPa	Gjelbër 238 - 896		1/10
651 0790			17 - 200 kPa	E kuqe - E bardhë 276 - 825		1/10
651 0791			30 - 400 kPa	E kuqe - Gri 406 - 1270		1/10
651 0792			17 - 210 kPa	E zezë 100 - 412 173,18		1/10
651 0793			17 - 210 kPa	Gjelbër 157 - 609		1/10
651 0794	3/4" (DN20)	DN20	35 - 400 kPa	E zezë 138 - 615		1/10
651 0795			35 - 400 kPa	Gjelbër 238 - 896		1/10
651 0796			17 - 200 kPa	E kuqe - E bardhë 276 - 825		1/10
651 0797			30 - 400 kPa	E kuqe - Gri 406 - 1270		1/10
651 0798			17 - 210 kPa	E zezë 100 - 412		1/10
651 0799			17 - 210 kPa	Gjelbër		1/10
651 0800			35 - 400 kPa	E zezë 138 - 615		1/10
651 0801	1" (DN25 e vogël)	DN20	35 - 400 kPa	Gjelbër 238 - 896		1/10
651 0802			17 - 200 kPa	E kuqe - E bardhë 276 - 825		1/10
651 0803			30 - 400 kPa	E kuqe - Gri 406 - 1270		1/10
651 0804	1" (DN25 e madhe)	DN40	17 - 400 kPa	E zezë 535 - 5830		1/10

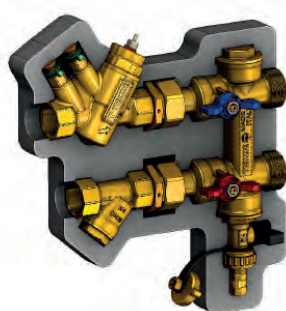

Komplet terminal për lidhje të fankoilave.

Art. 3162

Komplet shumëfunktional për njësitë e terminalit të ajrit për fankoil.

Kodi	Përmasat	Çmimi	Sasia.
311 0001	1/2"		1/1
311 0002	3/4"		1/1



Aksesorët : 6542SERV

Pastrimi/mirëmbajtja e instalimit

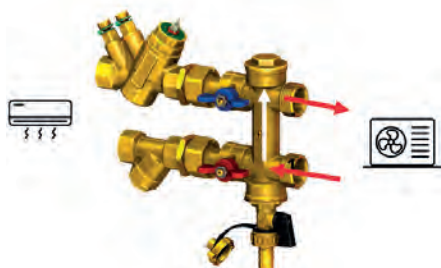

Operacioni normal

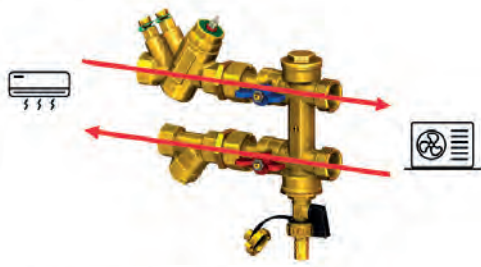

Aktuatori elektrotermik

Art. 6542ATT

Aktuatori elektrotermik për vendosje në valvulat balancuese TM-AUTO (për dimension deri 1"1/4)



Servomotor elektrik

Art. 6542SERV

Servomotor elektrik për valvula balancuese TM-AUTO. lidhja M30X1.5



Servomotor elektrik

Art. 6542SERV2

Servomotor elektrik për valvula balancuese TM-AUTO DN40 - DN50. lidhja M30X1.5

Funksioni i pastrimit



Kodi	Modeli	Çmimi	Sasia.
651 0814	NC on/off (230 Vac)		1/10
651 0816	NC 0-10V (24 Vac)		1/10



Për valvulën 6542CCS (Green 0 - Green 1 - Green 2) - 6540

Sharkoni
FletënTeknike



Kodi	Modeli	Çmimi	Sasia.
651 0817	Rregullimi i 2 pozicioneve, 3 pikëve (230V AC)		1/10
651 0819	0-10 V (24V AC)		1/10

Kodi	Modeli	Çmimi	Sasia.
651 0818	Rregullimi i 2 pozicioneve, 3 pikëve 0-10 V (24V AC)		1/10



Valvulë sferike me servomotor.

Art. 2138

Valvul sferike me dy kalime e motorizuar mashkull/femër me servomoto

Kodi	Përmasat	Furnizim	Çmimi	Sasia.
213 0020	1/2"	230 Vac		1/14
213 0003	3/4"	230 Vac		1/14
213 0007	1"	230 Vac		1/14
213 0019	1"1/4	230 Vac		1/14



E disponueshme edhe me 24Vac

Sharkoni
FletënTeknike



Valvul sferike trekalimtare

Art. 2137

Valvulë sferike me trekalime me - 3 bashkime - me servomotor

Kodi	Përmasat	Furnizim	Çmimi	Sasia.
213 0021	3/4"	230 Vac		1/4
213 0015	1"	230 Vac		1/4



E disponueshme edhe me 24Vac

Sharkoni
FletënTeknike



Valvul sferike trekalimtare

Art. 2136

Valvulë sferike me tre kalime e motorizuar me shmangie - me 4 bashkime - me servomotor.
Distancë e ndryshueshme mes qendrave (50-63 mm për valvula 3/4", 55-63 mm për valvula 1")

Kodi	Përmasat	Furnizim	Çmimi	Sasia.
213 0013	3/4"	230 Vac		1/4
213 0028	1"	230 Vac		1/4



E disponueshme edhe me 24Vac

Sharkoni
FletënTeknike



2.2. TIEMME BOX

Një zgjidhje e veçantë me cilësis të lartë për ngrohjen e hapësirave të zgjedhura (p.sh. banjo) qoftë në ndërtime të reja apo në rinovime. Lidhet me çdo sistem me temperaturë të lartë ose mesatare dhe ngroh hapësirën me ngrohje nën dysheme duke zëvendësuar kaloriferet ose klimatizimin, duke ofruar estetikë dhe kualitet të lartë ngrohjeje. Duke kombinuar TIEMME BOX dhe sistemin e ngrohjes nën dysheme SLIM, ulja e lartësisë së disponueshme është minimale.

Zgjidhja TIEMME BOX mund të kombinojë ngrohjen nën dysheme dhe kalorifer ose fankoil në të njëjtin instalim. TIEMME BOX siguron funksionimin e ngrohjes nën dysheme në temperaturë të ulët, sipas specifikimeve, pavarësisht se furnizohet nga uji me temperaturë më të lartë. Kjo mundësi rezulton jo vetëm në sigurimin e rehatisë së lartë termike në hapësirë, por edhe në reduktimin e energjisë dhe konsumit termik të instalimit.

Kufizon temperaturën e kthimit të qarkut të ngrohjes (RTL)



TIEMME BOX 2

Art. 4491

TIEMME BOX 2, stacion i integruar që lejon furnizimin e një sistemi ngrohjeje nën dysheme me temperaturë të lartë. Kontrolli i temperaturës së kthimit (RTL).

Kodi	Përmasat	Çmimi	Sasia.
449 0002	3/4"(ø18)		1/4

Version e kromuar (Art. 4491C):

Kodi	Përmasat	Çmimi	Sasia.
449 0021	3/4"(ø18)		1/4

Rregullon temperaturën e dhomës dhe kufizon temperaturën e kthimit (RTL)



TIEMME BOX 3

Art. 4492

TIEMME BOX 3, stacion i integruar që kryen rregullimin e rehatisë mjedisore dhe kufizon temperaturën e kthimit (RTL).

Kodi	Përmasat	Çmimi	Sasia.
449 0003	3/4"(ø18)		1/4

Version e kromuar (Art. 4492C):

Kodi	Përmasat	Çmimi	Sasia.
449 0023	3/4"(ø18)		1/4

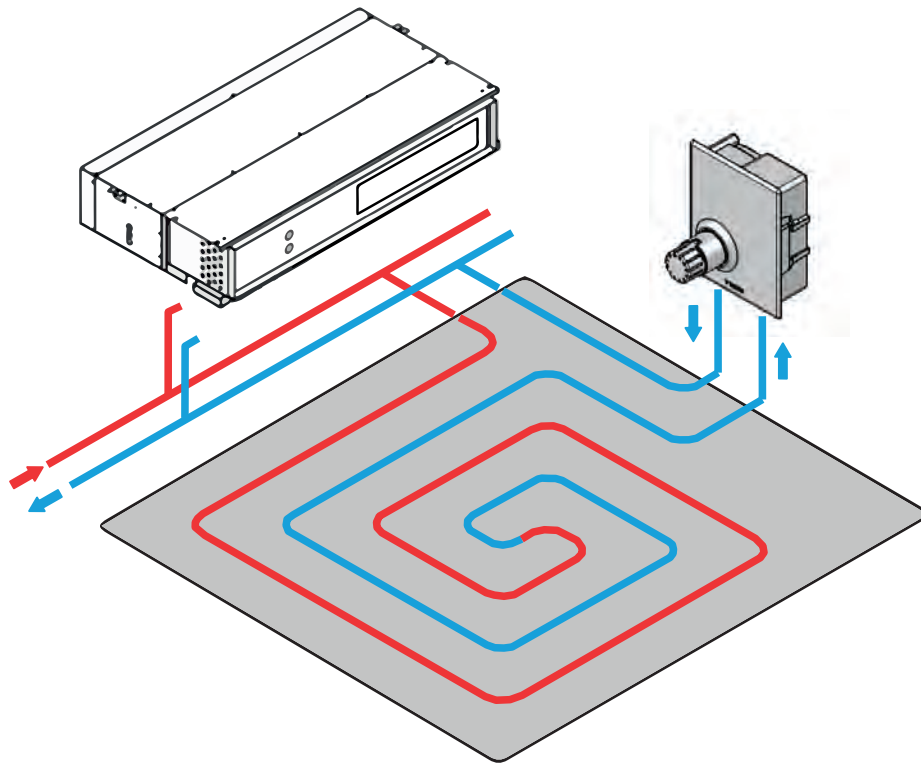

Udhëzime për lidhjet

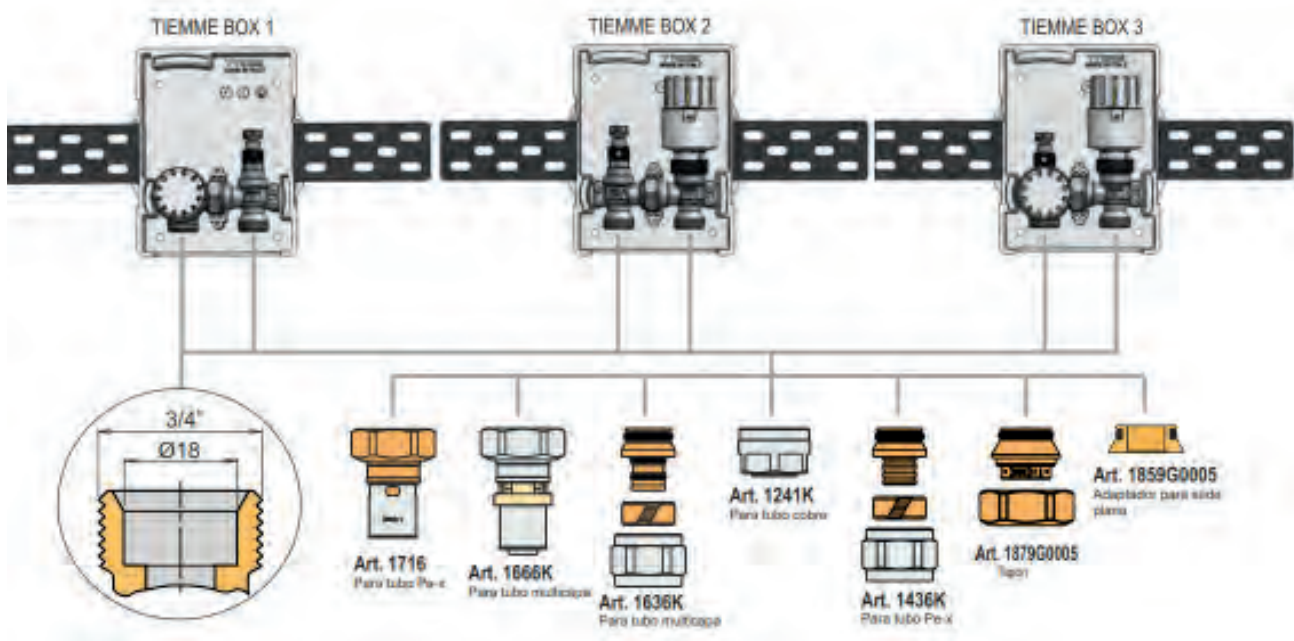

Sharkoni
FletënTeknike



2.3. SISTEME TIEMME SLIM



Panele të termoformuara me / pa izolim termik me forma të parafabrikuara për mbërthimin e tubit. Me distancë 50 mm, për shtrirje të drejtë ose 43/70 për shtrirje diagonale. E përshtatshme për renovime.

Kodi	Trashësia	Përmasat	Çmimi / m ²	m ² /Sasia	Sasia.
450 0641	-	19		17,92	16

Panel i zi izolues

Art. 4519

Tiemme Slim me panel ngjitëse



- 1) Përkufizimi
- 2) DysHEME
- 3) Llaç me lartësi të ulur
- 4) Tub 16x2/17x2mm
- 5) Panel izolues
- 6) Shirit perimetral

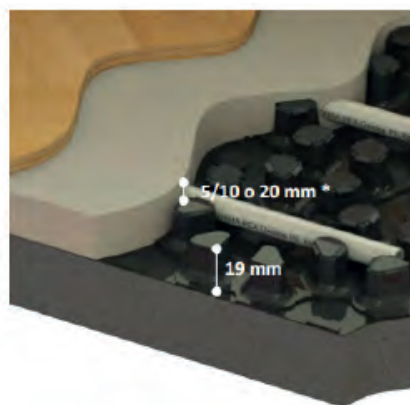

*Lartësia minimale e lejueshme e nivelizimit varet nga lloji i llaçit nivelizues do të përdoret.

Sharkoni
FletënTeknike





3. Rubineta TIEMME

3. 1. Rubinetë të integruara për lavaman



SKY T10

ART. T011

Me piletë me
CLICK CLACK 1"1/4:

Art.	Kodi	Ngjyra	Çmimi
T011	411450601		
T011W1	411450610		
T011B1	411450607		
T011NB1	411450608		
T011PG1	411450611		
T011WB1	411450609		

Disponueshëm dhe pa piletë



SKY T30

ART. T031

Me piletë me CLICK
CLACK 1"1/4:

Art.	Kodi	Ngjyra	Çmimi
T031	411450604		
T031W1	411450620		
T031B1	411450617		
T031NB1	411450618		
T031PG1	411450621		
T031WB1	411450619		

Disponueshëm dhe pa piletë



SKY Q10

ART. Q011

Me piletë me CLICK
CLACK 1"1/4:

Art.	Kodi	Ngjyra	Çmimi
Q011	411450606		
Q011W1	411450630		
Q011B1	411450627		
Q011NB1	411450628		
Q011PG1	411450631		
Q011WB1	411450629		

Disponueshëm dhe pa piletë



FLY

ART. F11

Me piletë me
CLICK CLACK 1"1/4:

Art.	Kodi	Ngjyra	Çmimi
F11	411490601		
F11W1	411490608		
F11B1	411490605		
F11NB1	411490606		
F11PG1	411490609		
F11WB1	411490607		

Disponueshëm dhe pa piletë



FLY ROUND

ART. FR11

Me piletë me
CLICK CLACK 1"1/4:

Art.	Kodi	Çmimi
FR11	411530601	

Disponueshëm dhe pa piletë

Art.	Kodi	Çmimi
FR11SS	411530602	



SKY Q20

ART. F11

Me piletë me CLICK
CLACK 1"1/4:

Art.	Kodi	Çmimi
F11	411490601	

Disponueshëm dhe pa piletë

Art.	Kodi	Çmimi
F11SS	411490602	

3.2. Koleksioni SKY T30



RUBINETË LAVAMANI

ART. T30SST

Rubinetë lavamani të koleksionit SKY

Me piletë CLICK CLACK 1"1/4:

Art.	Kodi	Ngjyra	Çmimi
T30SST	411450513		
T30SSTW1	411450531		
T30SSTB1	411450528		
T30SSTNB1	411450529		
T30SSTPG1	411450530		
T30SSTWB1	411450532		

Pa piletë

Art.	Kodi	Ngjyra	Çmimi
T30SS	411450517		
T30SSW1	411450536		
T30SSB1	411450533		
T30SSNB1	411450534		
T30SSPG1	411450535		
T30SSWB1	411450537		



Me piletë 1" 1/4:



RUBINETË LAVAMANI

(E GJATË)

ART. T19SST

Rubinetë lavamani të koleksionit SKY

Art.	Kodi	Ngjyra	Çmimi
T19SST	411456911		
T19SSTW1	411456904		
T19SSTB1	411456901		
T19SSTNB1	411456902		
T19SSTPG1	411456903		
T19SSTWB1	411456905		

Pa piletë

Art.	Kodi	Ngjyra	Çmimi
T19SS	411456912		
T19SSW1	411456909		
T19SSB1	411456906		
T19SSNB1	411456907		
T19SSPG1	411456908		
T19SSWB1	411456910		



Rubinetë të integruara

ART. T031

Rubinetë inkaso për lavaman

Me piletë CLICK CLACK 1"1/4:

Art.	Kodi	Ngjyra	Çmimi
T031	411450604		
T031W1	411450620		
T031B1	411450617		
T031NB1	411450618		
T031PG1	411450621		
T031WB1	411450619		

Pa piletë

Art.	Kodi	Ngjyra	Çmimi
T031SS	411450603		
T031SSW1	411450625		
T031SSB1	411450622		
T031SSNB1	411450623		
T031SSPG1	411450626		
T031SSWB1	411450624		

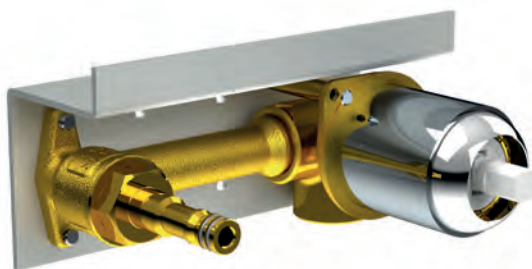

Trupi inkaso prej bronzi



Rubinetë për bide

ART. T11SST

Me piletë CLICK CLACK 1"1/4:

Art.	Kodi	Ngjyra	Çmimi
T11SST	411450802		
T11SSTW1	411450814		
T11SSTB1	411450811		
T11SSTNB1	411450812		
T11SSTPG1	411450813		
T11SSTWB1	411450815		

Pa piletë

Art.	Kodi	Ngjyra	Çmimi
T11SS	411450804		
T11SSW1	411450809		
T11SSB1	411450806		
T11SSNB1	411450807		
T11SSPG1	411450808		
T11SSWB1	411450810		



Rubinetë vaske

ART. T13

Rubinetë për vaskë (përfshirë kokë dushi , me teknologji kundër gëlqeres)

Art.	Kodi	Ngjyra	Çmimi
T13	411490126		
T13W1	411490130		
T13B1	411490127		
T13NB1	411490128		
T13PG1	411490129		
T13WB1	411490131		



Rubinetë vaske

ART. F03SA

Art.	Kodi	Ngjyra	Çmimi
F03SA	411490102		
F03SAW1	411490114		
F03SAB1	411490111		
F03SANB1	411490112		
F03SAPG1	411490113		
F03SAWB1	411490115		

Rubinetë dushi /vaske të integruara

Rubinetë dushi /vaskë inkaso me 2 ose 3 dalje.



2 dalje

Art.	Kodi	Ngjyra	Çmimi
F05	411490402		
F05W1	411490408		
F05B1	411490405		
F05NB1	411490406		
F05PG1	411490407		
F05WB1	411490409		



3 dalje

Art.	Kodi	Ngjyra	Çmimi
F15	411490428		
F15W1	411490433		
F15B1	411490430		
F15NB1	411490431		
F15PG1	411490432		
F15WB1	411490434		

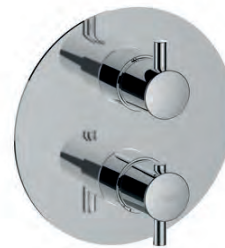

3 dalje







Art.	Kodi	Çmimi
F16	411016001	



Rubinetë dushi

ART. F06

Rubinetë dushi të integruara

Art.	Kodi	Ngjyra	Çmimi
F06	411490401		
F06W1	411490414		
F06B1	411490411		
F06NB1	411490412		
F06PG1	411490413		
F06WB1	411490415		

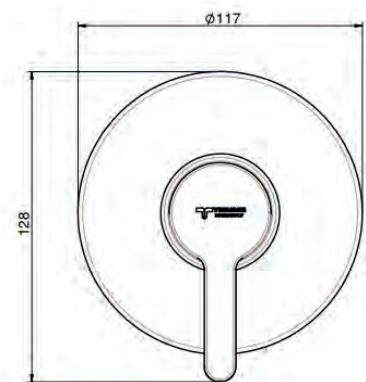
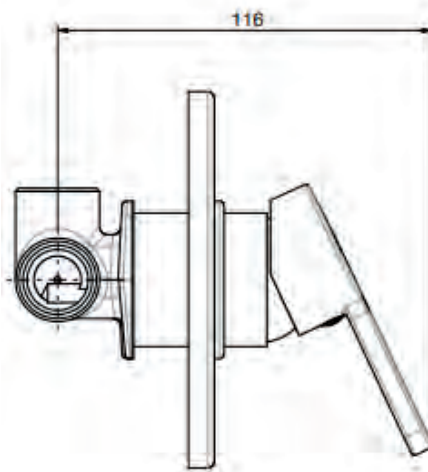
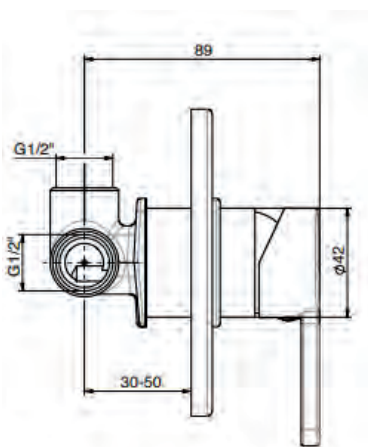

Rubinetë me termostat

ART. T100

Rubinetë termostatike me ose pa aksesorë

Art.	Kodi	Ngjyra	Çmimi
T100	411010301		



Rubinetë me termostat

ART. T200

Rubinetë termostatike pa aksesorë

Art.	Kodi	Ngjyra	Çmimi
T200	411010302		

3.3. Koka Dushi

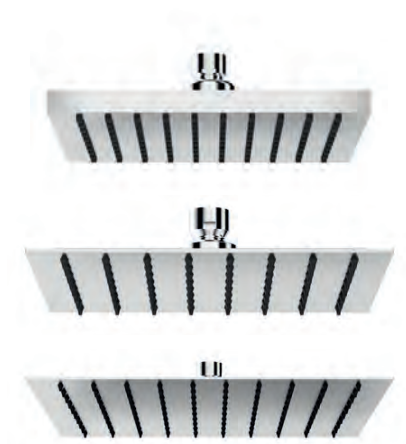

Kokë dushi

Art. DC304 | DC308 | DC310

Koka dushi me teknologji kundër gëlqeres

Art.	Kodi	Materiali	Përmasat	Çmimi
DC304	4180323	ABS	200x200 - H 14 - 1/2" F	
DC308	4180524	INOX AISI 316	200x200 - H 2 - 1/2" F - 9 L/ MIN	
DC310	4180529	INOX AISI 316	300x300 - H 2 - 1/2" F - 9 L/ MIN	



Dorezë dushi

ART. DC401

L 400 - 1/2" A x 1/2" A

Art.	Kodi	Çmimi
DC401	4180326	



Kokë dushi për mur gipsi

ART. DC401

Koka dushi për mur gipsi (340 x 340 - H2 - 1/2F - 9lit/min)

Art.	Kodi	Çmimi
DC313	4180535	



Kit dushi

ART. DC206

Kit dushi me kokë në vija katrore , me tub fleksibël dhe mbështetje .

Art.	Kodi	Çmimi
DC206	4180439	

3.4. Rubinetë me ndërprerje



Rubinetë me ndërprerje

ART. 3901C

Rubinetë me ndërprerje e kromuar. Me rozetë të kromuar.

Kodi	Përmasat	Çmimi	Sasia
295 0013	1/2" x 3/8"		10/50
295 0008	1/2" x 1/2"		10/50



Rubinetë me ndërprerje

ART. 3904C

Rubinetë me ndërprerje (me sferë) i kromuar me rozetë me ndërprerje On/Off - 1/4 e xhiros

Kodi	Përmasat	Çmimi	Sasia.
295 0037	1/2" x 3/8"		10/50
295 0070	1/2" x 1/2"		10/50



Katalogu



SHARKONI
Katalogun

4. Instalime BIM

Dizajnoni instalimin e sistemit të furnizimit me ujë në çdo lloj banjoje dhe çdo lloj konfigurimi me metodologjinë BIM, për një dizajn më të saktë dhe më të detajizuar për një njësi ose për më shumë banjo të ngjashme në projekte të mëdha, me mbështetjen e departamentit tone BIM.

Bibliotekat falas të shkarkueshme nga <https://lnkd.in/dV3yvbns> ose <https://lnkd.in/d49XkNkE>

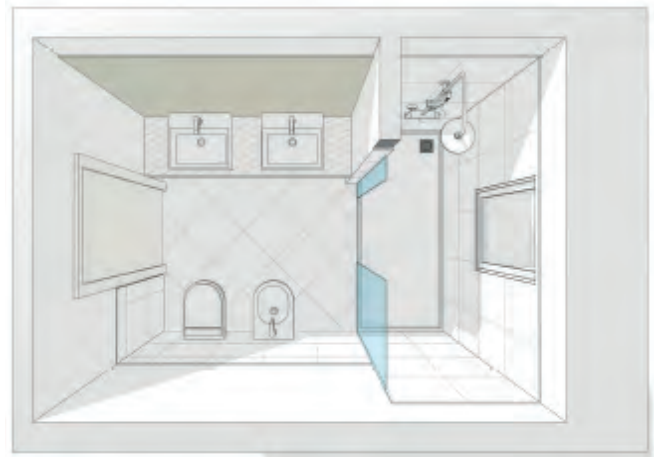
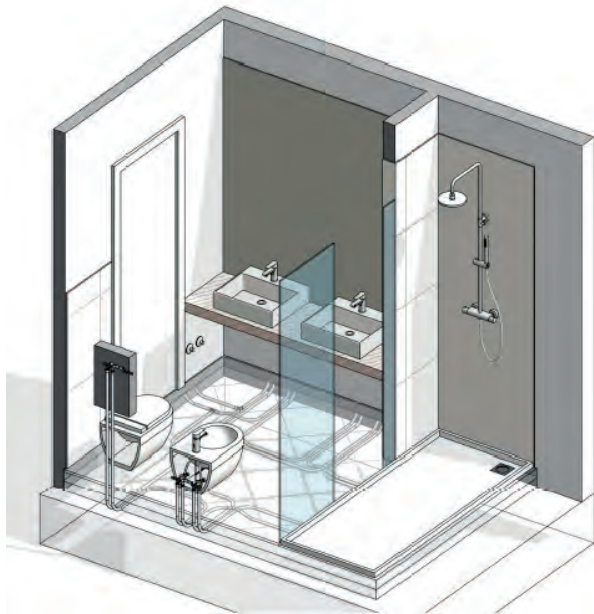

Shëmbull instalimi me qark në seri me pajisje në form U të teknologjisë press 1676USM - 1654U dhe valvul sferike inkaso me formë U1690U

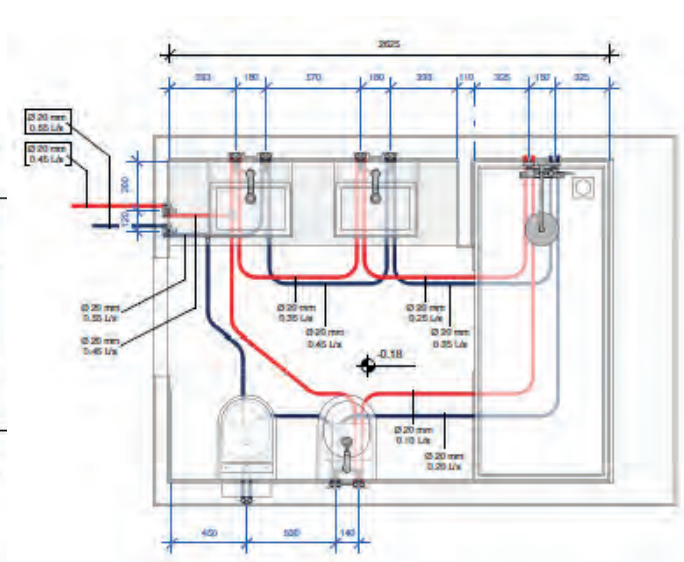
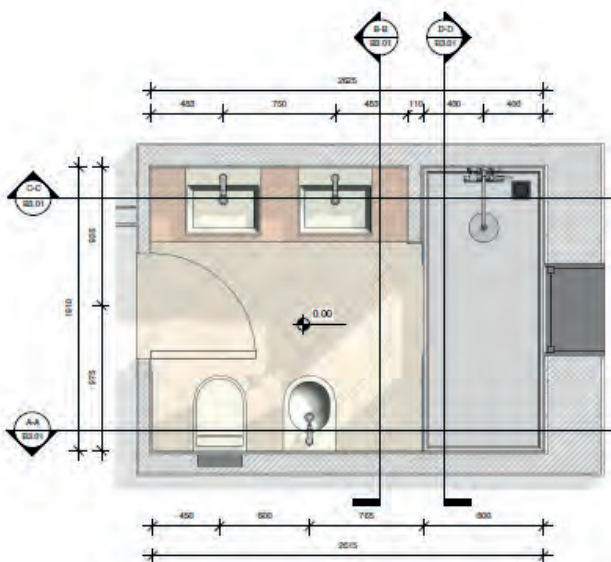

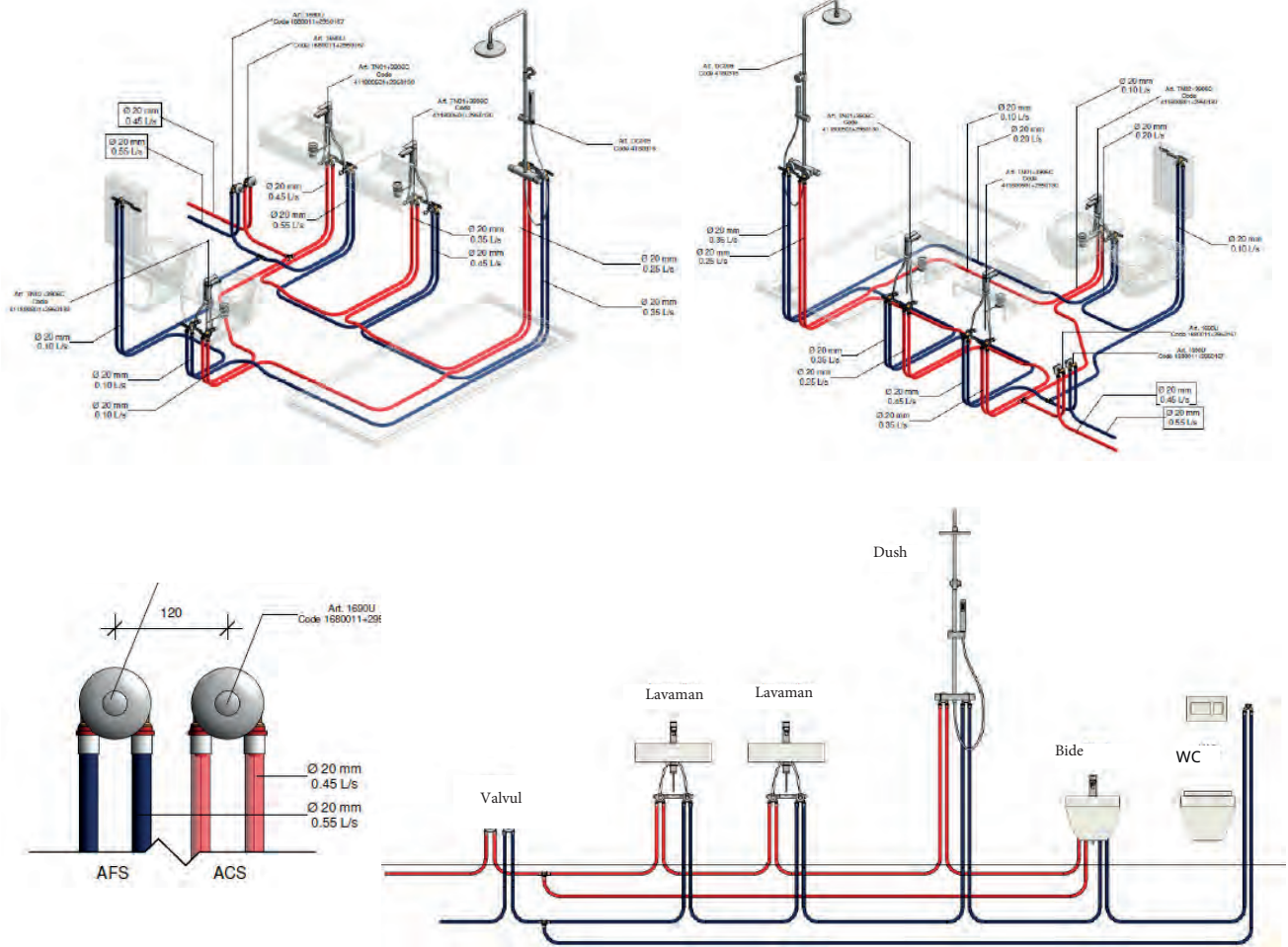

Shëmbul instalimi banjo me kolektor të paramontuar SANIBOX 3023 dhe 1481-1656

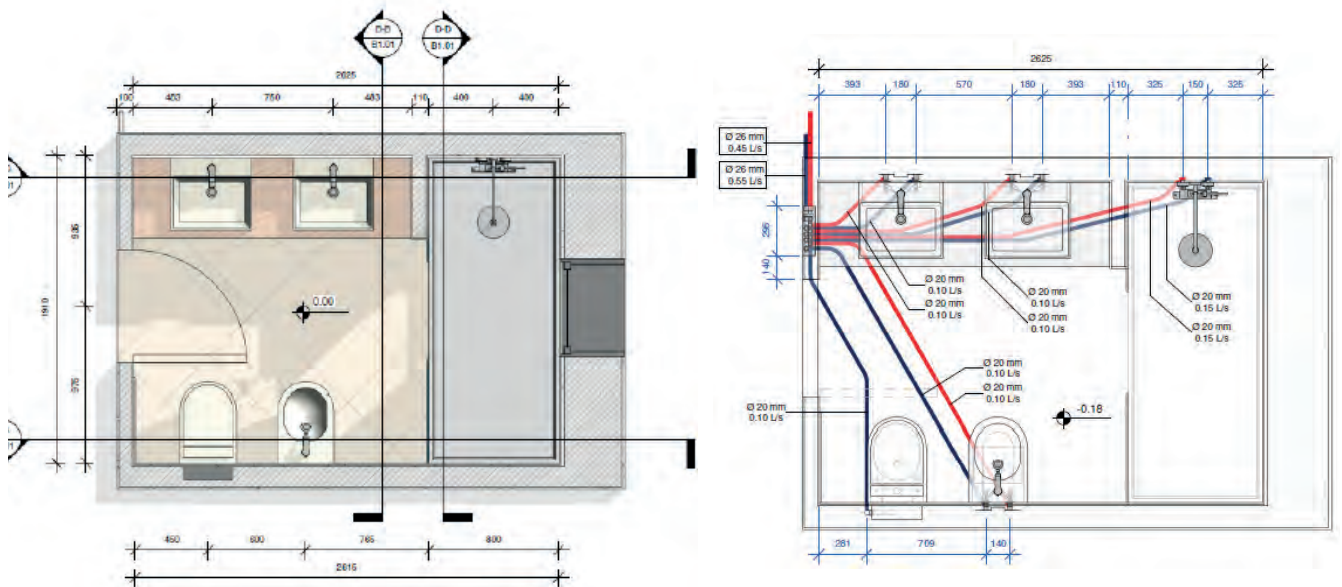

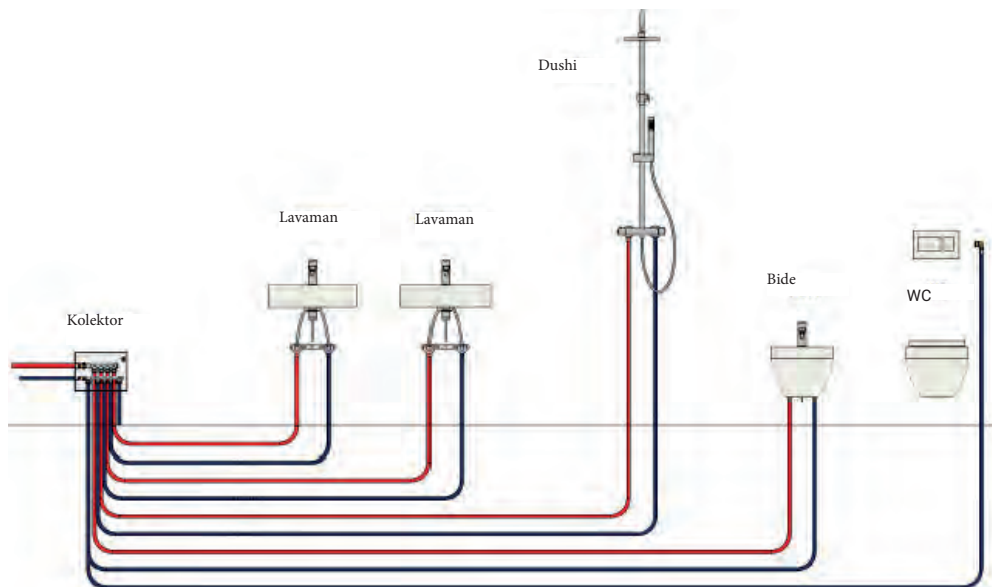
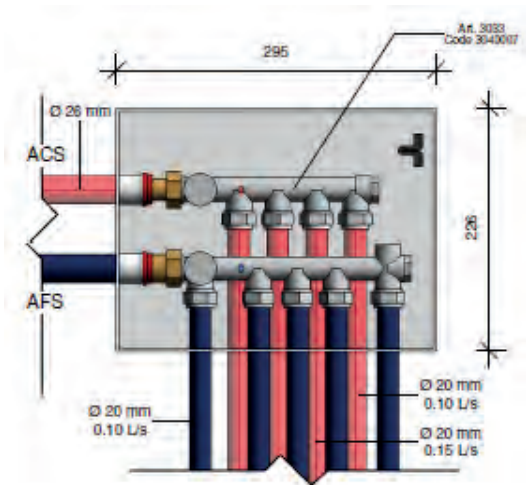
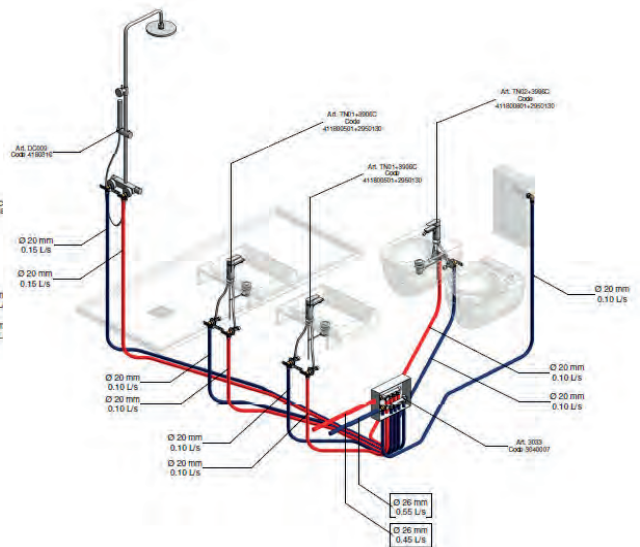
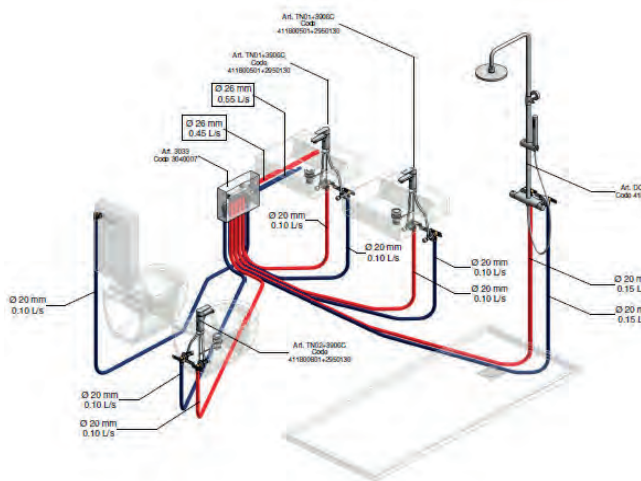



TIEMME RACCORDERIE S.p.A.

Via Cavallera, n.6/A-25045 Castegnato (BS) - Italy
Tel. +39 030 2142211 - Fax +39 030 2142206
info@tiemme.com

www.tiemme.com



SQ

