



## RADIANT SYSTEMS

R2.B20.0 / EN





---

**1**      **RADIANT FLOOR SYSTEMS**



---

**2**      **RADIANT CEILING/WALL SYSTEMS**



---

**3**      **RADIANT INDUSTRIAL SYSTEMS**



---

**4**      **MANIFOLDS AND MIXING UNITS FOR DISTRIBUTION**



---

**5**      **HYDRAULIC SEPARATORS, DISTRIBUTION MANIFOLDS AND PUMPING STATIONS FOR THERMAL PLANTS**



---

**6**      **CLIMAV 2.0 BUILDING MANAGEMENT THERMOREGULATION**



---

**7**      **TEMPERATURE CONTROLS**



---

**8**      **AIR TREATMENT**



**DISCOVER THE  
TIEMME RANGE  
AND DOWNLOAD THE  
TECHNICAL DOCUMENTATION**



"Everyone, with their skills and experience, has always been essential to our company. It is something precious that paves the way to a better understanding of all Customers' needs, be them in Italy or abroad, through targeted and innovative services and products".

The President

Giuliano Gnutti

A handwritten signature in black ink, appearing to read "Giuliano Gnutti". The signature is fluid and cursive, with a long horizontal stroke at the end.



**The Gnutti Cirillo Group** has been a leading entrepreneurial business from the 50s, with a well-rooted activity all over the territory. A cluster of companies leaders in the technical-production chain, turning raw material into a fine product. A perfect union between Tradition, Professionalism, Quality, Technology and Know-How, so to offer the best service, every day.

The Gnutti Group was conceived from the development and evolution of the company Gnutti Cirillo S.p.A.



**TIEMME Raccorderie** was founded 80s as a manufacturer and distributor of fittings, brass valves and pipes. In 1994 it joined the Gnutti Group, when the company was facing a radical change. The 2000s represent a phase of further growth and evolution for the company through the development of integrated systems in the HVAC industry. In 2012, "Tiemme Lab" was founded in Castagneto - an innovative laboratory for heat technologies. Affiliates in Spain, Greece, and Romania aim to operate in an increasingly wider and demanding market, with an international perspective.



**Gnutti Cirillo S.p.A.** is the parent company of the group, established in 1951 by Cirillo Gnutti as a mechanics company producing equipment and molds. Nowadays, it is a global leader in hot molding and mechanical processing of brass and other non-ferrous metals. Thanks to an efficient and competent management, Gnutti Cirillo S.p.A. can meet any demand through a self-sufficiency production chain.

Starting from the design, through the manufacture of the equipment and tools, the hot-molding of brass, machining, surface treatments, automatic assemblies until the packaging of the finished product; everything is proudly carried out within the group with possible customization following the customer's specifications.

In 2000 the Odolo (BS) plant was added to the historic headquarters in Lumezzane (BS).



Over the years, the group's internationalization process went on and on with the creation of **Metal Forming Technology Inc.** Based in Michigan, MFT has achieved high efficiency standards in the production of hot-stamped brass items processed following customer specifications. The company also provides logistics and customer care on behalf of Gnutti Cirillo S.p.A. for the North-American and Canadian markets.



**EMC Component** is a company founded in 2011, specializing in the design, production and marketing of accessories for power and distribution transformers.



UNI EN ISO 9001:2015



The company is based in Castegnato (Brescia) and operates in two adjacent plants, one of approximately 7.000 m<sup>2</sup> covered, where the production department with transfer machines and offices are located, the other with an area of 15.000 m<sup>2</sup> where the warehouses and the PEX department for the production of the cross-linked polyethylene pipe are located.

Tiemme Raccorderie® Quality System is the tool to make sure that all customers get products and services meeting their expectations for constant high quality and timely delivery, in a process of continuous improvement, in full respect of safety and of the environment.

In 1999 TIEMME Raccorderie® S.p.A. was granted the ISO 9002 certification of its quality system and in 2003 the ISO 9001 certification, natural consequence of the total quality policy and achievement of the excellence as pursued by the company. Tiemme Raccorderie® S.p.A. high quality products are controlled and renowned all around the world by over 70 of the most authoritative certification bodies. Efficient and modern service of trained technicians is fully available to our customers.

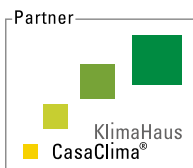





**ROMANIA**

Branch office  
*Bucharest*

**SPAIN**

Branch office  
*Valencia*

**ITALY**

TIEMME RACCORDERIE SPA

**GREECE**

Branch office  
*Athens*

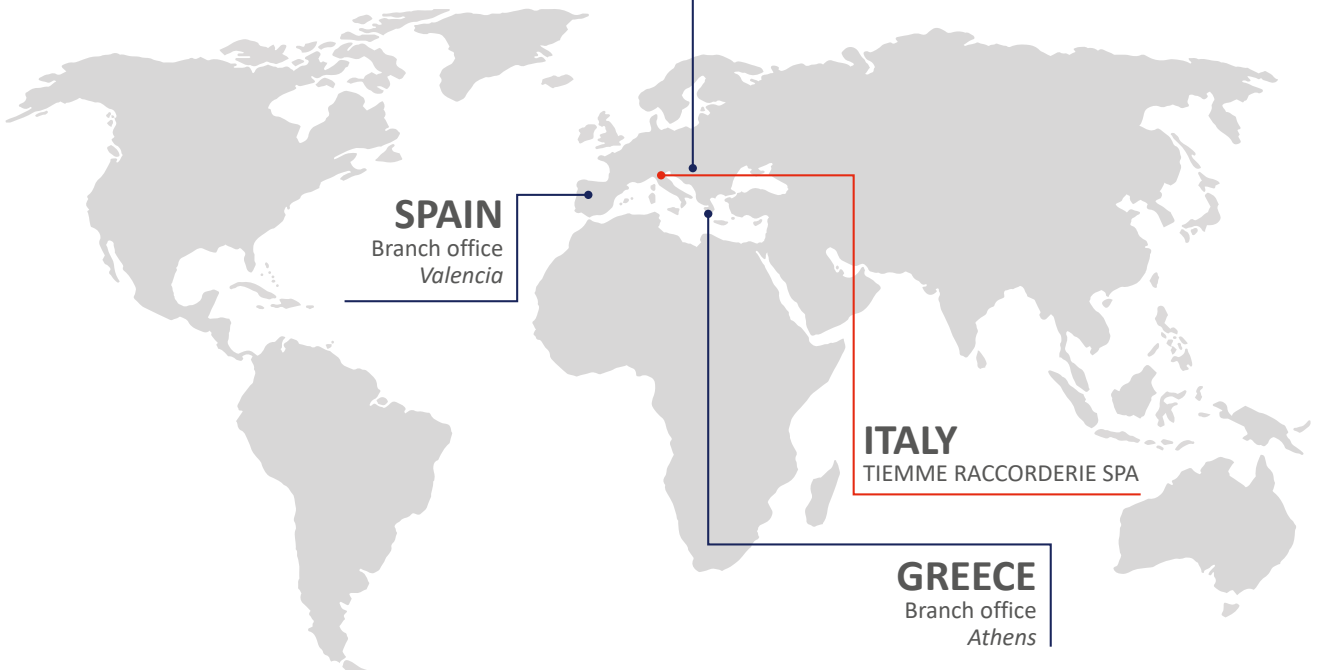



# TIEMME, CERTIFIED QUALITY

		<b>ITALY</b> RINA REGISTRO NAVALE ITALIANO			<b>BELGIUM</b> FEDERATION REPRESENTING THE PUBLIC SERVICES OF DRINKING WATER AND WASTE WATER
		<b>ITALY</b> POLITECNICO DI MILANO FONDAZIONE LABORATORIO PROVE MATERIE PLASTICHE			<b>UKRAINE</b> ORGANO DI CERTIFICAZIONE CCV "TYSK"
		<b>ITALY</b> ISTITUTO GIORDANO			<b>SLOVAKIA</b> TECHNICKY SKUSOBNY USTAV
		<b>ITALY</b> ICIM			<b>CZECH REPUBLIC</b> VYZKUMNY USTAV POZEMNICH STAVEB – CERTIFIKACNI SPOLECNOST S.R.O.
		<b>ITALY</b> ISTITUTO NAZIONALE ASSICURAZIONE INFORTUNI SUL LAVORO			<b>CZECH REPUBLIC</b> STROJIRENSKY ZKUSEBNÍ ÚSTAV
		<b>GERMANY</b> DEUTSCHER VEREIN DES GAS-UND WASSERFACHES			<b>RUSSIA</b> NASHOL CERTIFICATION CENTER CC
		<b>AUSTRIA</b> ÖA HYGIENE CERTIFICATE			<b>RUSSIA</b> HYGIENE CERTIFICATE
		<b>DENMARK</b> ETA - DANISH BOARD OF EUROPEAN TECHNICAL APPROVAL FOR CONSTRUCTION PRODUCTS			<b>RUSSIA</b> EAC CERTIFICATE
		<b>DENMARK</b> CERTIFIKAT 03-00012			<b>POLAND</b> PANSTWOWY ZAKLAD HIGIENY NATIONAL INSTITUTE OF HYGIENE
		<b>DENMARK</b> DTI ENERGY DANSK TEKNOLOGISK INSTITUT			<b>POLAND</b> INSTYTUT TECHNIKI BUDOWLANS
		<b>NORWAY</b> NORWEGIAN BUILDING RESEARCH INSTITUTE			<b>HUNGARY</b> EPITESUGYI MINOSEGELLENORZO INTEZET INSTITUTE FOR QUALITY CONTROL OF BUILDING
		<b>SWEDEN</b> SWEDISH INSTITUTE FOR TECHNICAL APPROVAL IN CONSTRUCTION			<b>UNITED KINGDOM</b> BRITISH GAS TECHNOLOGY
		<b>FINLAND</b> YMPÄRISTÖMINISTERIÖN TYYPPIHYVÄKSYNTÄPÄÄTÖS THE FINNISH MINISTRY OF ENVIRONMENT			<b>UNITED KINGDOM</b> WATER REGULATION ADVISORY SCHEME
		<b>SPAIN</b> AENOR			<b>FRANCE</b> LABORATOIRE SANTÉ ENVIRONNEMENT HYGIÈNE DE LYON
		<b>HOLLAND</b> CENTRUM VOOR GASTECHNOLOGIE			<b>FRANCE</b> CENTRE SCIENTIFIQUE ET TECHNIQUE DU BÂTIMENT
		<b>HOLLAND</b> CERTIFICATIE EN KEURINGEN			<b>FRANCE</b> CERTIFICATION NF
		<b>PORTUGAL</b> ASSOCIAÇÃO PARA A CERTIFICAÇÃO DE PRODUTOS			<b>BELARUS</b> INSTITUTE
		<b>ROMANIA</b> AGREMENT TEHNIC ÎN CONSTRUCTII ROMÂNIA			<b>IRELAND</b> IRISH AGREEMENT BOARD BUILDING PRODUCT CERTIFICATION
		<b>BULGARIA</b> TUV RHEINLAND BULGARIA LTD.			<b>SERBIA</b> INSTITUTE
		<b>AUSTRALIA</b> WATERMARK LICENCE			<b>EUROPE</b> MARCHIO CE DI PRODOTTO
		<b>AUSTRALIA</b> OCEANA MARK			<b>VIETNAM</b> TESTING CENTER 3
		<b>BELGIUM</b> UNIVERSITE LIBRE DE BRUXELLES			<b>SOUTH AFRICA</b> AENOR



### 4514PANGRF

Thermoformed panel with ashlar made in foam polystyrene, sintered with graphite and bonded to a hard black polystyrene black foil with ashlar. Limited ashlar height: only 18 mm

PAGE 35

---



### 5507

Ventilation unit with high efficiency heat recovery unit for vertical recessed installation

PAGE 198

---



### 5508O

Controlled mechanical ventilation unit with high efficiency heat recovery unit - horizontal installation, with hydronic battery for heating and cooling

PAGE 207

---



### 5508V

Controlled mechanical ventilation unit with high efficiency heat recovery unit - vertical installation, with hydronic battery for heating and cooling

PAGE 208

---

# INDEX

ART	PAGE	ART	PAGE	ART	PAGE	ART	PAGE	ART	PAGE	ART	PAGE
0200B	22	1859	120	3872POL	117	4503	49	4532	41	5503GPT	213
0200B	26	1859	152	3873	108	4503	53	4532	45	5503GRI	211
0200B	30	1863	133	3873BY	108	4503	56	4532	49	5503GRIAIR	212
0200B	36	1865	121	3873JBYD	105	4503	63	4532	53	5503OR	210
0200B	40	1879	102	3873R	109	4503	98	4532	63	5503PLE	212
0200B	44	1881	152	3873RBY	109	4503	100	4533	100	5503RAC	212
0200B	48	1889TERMO	120	3873RBYDJ	105	4505GRF	47	4535	101	5503RCOL	209
0200B	52	1890ISOL	109	3874	119	4505POL	51	4539	22	5503RCOLP	209
0200B	56	1890ISOL	114	3874ISOL	120	4507	22	4539	26	5503RCOLSL	212
0200B	62	1890ISOL	120	3874P	120	4507	26	4539	30	5503REG	210
0200B	89	1890JISOL	105	3877	112	4507	30	4539	37	5503ROVSL	212
0200B	98	1939	106	3877BY	112	4507	36	4539	41	5503SIL	213
0200B	100	1939	110	3877R	113	4507	40	4539	45	5503TAP	210
450XPS	97	1939	116	3877RBY	113	4507	44	4539	49	5503TAPSL	212
0660S	102	1940	106	3878	108	4507	48	4539	53	5503TCOMPU	210
1436N	101	1940	110	3878BY	108	4507	52	4539	57	5503TSLPU	211
1436N	130	1940	114	3878RS	122	4507	62	4539	63	5503TUB	209
1436N06	101	1940	118	3879	112	4507	98	4539	80	5503VAL	213
1436N06	120	1941	121	3879BY	112	4507	100	4539	85	55040	195
1480P	22	2070	133	3879R	113	4508	36	4539	89	550401	196
1480P	26	2075KIT01	131	3879RBY	113	4508	40	4539	98	5504V	200
1480P	30	2075KIT02	131	3880GPF	160	4508	44	4539	100	5506	191
1480P	36	2075KIT03	160	3880GSM	160	4508	48	4540	36	5507 ■	198
1480P	40	2095R	152	3887	131	4508	52	4540	40	5507COM ■	199
1480P	44	2120R	116	3888	132	4508	56	4540	44	5507COP ■	198
1480P	48	2121CP	152	3889	132	4508	63	4540	48	5507T ■	198
1480P	52	2121CPISOL	121	3890BV	131	4511	62	4540	52	5508COM ■	208
1480P	56	2121PTISOL	105	3890P	161	4513	62	4540	56	5508O ■	207
1480P	62	2121PTISOL	109	3890PU	161	4514PANGRF ■	35	4540	62	5508V ■	208
1480P	98	2121PTISOL	114	3890PV	161	4516	98	4540	98	5530E	179
1480P	100	2121PTISOL	116	3890PW2	132	4517GRF	29	4540	100	5530E1	179
1495	101	2371	118	3890PW2	161	4517NA	30	4601	182	5530E2	179
1552FD	152	2371ISOL	118	3890PW5	161	4518GRF	25	4606	182	5530I9	180
1555SET	132	2990G	133	3895KCL	131	4519	21	4607	183	5530I10	180
1557SET	161	3049SKIT	133	3895KHT	132	4520C	56	4612	183	5530M1	173
1557SET	132	3051ISOL	105	3895KPF	131	4520F	49	4745MANOP	160	5530M2COM	178
1602	152	3051ISOL	109	3896CL	128	4520F	53	5502GHWZV	205	5530M5	178
1636N	101	3051ISOL	114	3896CLBY	128	4520F	101	5503BOB	210	5530M6	178
1636N	130	3144	139	3896CLHT	128	4520G	48	5503BOBSL	211	5530M8	172
1651	81	3144ISOL	139	3896CLHTBY	128	4520G	52	5503BOC	211	5530P	179
1651	85	3144MAG	139	3896PF	126	4521	48	5503COL	209	5530S1	175
1652	152	3165	138	3896PFBY	126	4521	52	5503COLP	209	5530S2	176
1653	81	3165ISOL	138	3896PFHT	126	4522	101	5503COLT	209	5530S3	176
1653	85	3167ISOL	138	3896PFHTBY	126	4522A	101	5503CUR	210	5530S4	174
1657	81	3352	133	4500GRF	39	4525	100	5503CUIROSL	212	5530S5	174
1657	85	3670	80	4502PANGRF	43	4526	98	5503CURVSL	212	5530S6	175
1665	152	3670	85	4502SIL	61	4527	40	5503DIF	213	5530S7	173
1665	161	3670	89	4503	22	4527	44	5503DIFR	213	5530S10	177
1677	90	3868G	124	4503	26	4527	62	5503FAS	209	5530S11	177
1681MINI	90	3868GHTPP2	124	4503	36	4530	101	5503FIL	211	5530V	172
1695TM03	90	3868GHTPP3	124	4503	40	4531	57	5503GIU	210	5534G	158
1828Z	152	3871POL	115	4503	44	4532	37	5503GIUSL	212	5534G3P	159

■ New product

# INDEX

ART	PAGE	ART	PAGE
5535DIFF	160	9561KIT02	160
5535G	153	9562SERV	160
5535G3P	155	9567	130
5535GPF	154	9567KIT	120
5536G	156	9568	130
5536GS	157	9573	182
5537KIT	160	9574	182
5538G2M3	146	9589	184
5538G2M4	146	9590	184
5538G3M4	146	9591	184
5538G3M6	146	9592	184
5538G4M6	147	9683CU	189
5538G4M8	147	H9708	133
5538X	143	H9709	133
5539X	143	RG	84
5540G2M4	147	RGN	80
5540G3M4	147	RGN	85
5540G3M6	148	RGNU	80
5540G4M6	148	RGRF	72
5540G4M8	148	RGRF30	74
5540G5M6	148	RGRFAL75	76
5540G5M10	149	RGRFID75U	76
5540G6M8	149	RGRFU	72
5540G6M12	149	RGRFU30	74
5540G7M8	149	SK600PL	88
5540G7M14	150	SK600PLN	89
5540X	143		
5540X	143		
5570	80		
5570	85		
5570	89		
5575P	55		
5576S	56		
5577S	57		
5581	90		
5581C	90		
5581T	90		
5600FH	188		
5600FHDWZ	188		
5600FHWZ	188		
5600GH	187		
5600GHWZ	187		
5601A	189		
5601FFH	189		
5601FGH	189		
5601P	189		
5601PGH	189		
5602CON	209		
5602GHWZ	204		
7166	141		
7167	141		
9561KIT01	131		

■ New product

<b>A</b>	<b>Radiant conditioning</b>	
	Core principles of radiant conditioning	2
	Excellent comfort	3
	Moving towards sustainable decisions	4
<b>B</b>	<b>Regulations for radiant systems</b>	5
<b>C</b>	<b>Energy efficiency</b>	6
<b>D</b>	<b>Know-how and partnerships</b>	7
<b>E</b>	<b>EFESTO</b>	8
<b>F</b>	<b>10 years warranty</b>	9
<b>G</b>	<b>The technical team</b>	10
<b>H</b>	<b>Tiemme Technical Service</b>	11
<b>I</b>	<b>Tiemme LAB</b>	12
<b>L</b>	<b>Tiemme BIM</b>	13

Tiemme radiant solutions provide an excellent, optimized-cost indoor climate ideal for both living and working.

Our energy-efficient solutions can be combined with renewable energy sources, contributing to reduce energy consumptions and carbon emissions, ensuring the best conditions for an ideal indoor climate.

Tiemme offers water-based floor, wall, and ceiling heating and cooling systems.

Due to their low-temperature functioning, radiant systems are the most cost-effective way in terms of energy to heat indoor environments in a building.

Low temperatures guarantee the highest efficiency of heating sources, preferably renewable sources like geothermics or heat pumps. This results in low energy consumption and decreased carbon emissions.

Furthermore, radiant heating provides the highest comfort and can also be used as a cooling system. Its silent installation results in maximum freedom in terms of architecture and design.

**There is no plausible reason to choose a different indoor heating or cooling solution.**

Radiant heating/cooling systems rely on a radiation principle, resulting as the most innovative, adaptive, safe, and effective way to provide comfort in any type of building.

Using floor as a heating/cooling element enables the use of a low-temperature fluid, thus providing maximum comfort, due to radiation, and saving energy and money.

### How it works

Floor heating systems generate circulating low-temperature water (35÷40°C) channeled in closed circuits of thermoplastic piping, buried in the screed underneath flooring.

Circuits create a large radiant surface, which heats the room upwards by layering the heat according to an ideal temperature curve: warmer feet, cooler head.

This radiant heating system distributes heat in a way opposite than radiators or convectors that warm the environment by creating a high layer of heat, resulting in a significant loss of energy, money, and comfort.





Comfort is a condition of psychological and physical well-being resulting from the individual perception of temperature, humidity, noise and brightness of an indoor environment.

A radiant system certainly concerns “thermo-hygrometric” comfort, an aspect highly impacted by the type of heating/cooling system installed.

Due to the heating transmission occurring via radiation, a radiant system infuses people with the same sensation of well-being experienced when kissed by the winter sun.

Although this happens at a low temperature, the sun transfer its warmth to our body by creating a pleasant feeling of well-being. Laboratory tests have shown that among available heating/cooling systems, radiant heating with proper size and installation represents the closest ideal curve, where layered temperature concentrates heat towards the floor, gradually cooling the environment upwards, inverting the direction if the system includes radiators or fan convectors.



Paris agreements' objectives (COP 21), which have been ratified by most Governments in the world, and the energy certification of building required by the European Directive 2002/91/EC are factors pressing for sustainable decisions to be taken on systems installed in buildings.

It is worth to point out that 40% of the entire European energy consumption is ascribable to buildings. Savings are our major energy source and a better energy efficiency cannot but be a shared goal.

**HIGH ENERGY EFFICIENCY IMPLIES SAVING MONEY**

The system operates mostly by transferring the heat via radiation and only partially via convection, thus resulting highly efficient even in environments with a temperature of 35-40°C. The small thermal gradient between the temperature of the radiant system and room temperature reduces dispersion and improves the system efficiency.

Low temperatures of the fluid circulating in the system significantly reduce the energy required, saving an average of 20% energy per year in home systems, and up to 40-50% in high-ceiling buildings like warehouses, places of worship, gyms, etc., subsequently granting a significant saving of money.

**RADIANT CONDITIONING: A VALUABLE AND AWARE CHOICE**

In the previous paragraph we highlighted that a radiant system secures a significant saving in terms of energy and, as a consequence, money. However, does the reduction of energy consumptions contributes to preserve our planet? Saving energy is not a mere economic benefit but must become an informed decision for our future.



UNI EN 1264 is the technical regulation defining all the components of floor, wall, and ceiling systems. The same standard defines the methods that shall be used to design radiant systems. Here we are going to summarize the core aspects relating to what was said in the section pertaining to environmental well-being, and we will try to define the aspects that can be helpful in the design and installation of said systems.

### INSULATING LAYERS

The standard carefully tackle the aspect of thermal resistance of the insulating layer found either between the system and the outdoor environment or between the system and the adjacent environment. "Insulating layer" is understood as what is placed right below piping and this also applies in the event that said layer results from coupling two or more panels.

Thermal resistance that shall be considered are reported in the diagram and in the relevant table.

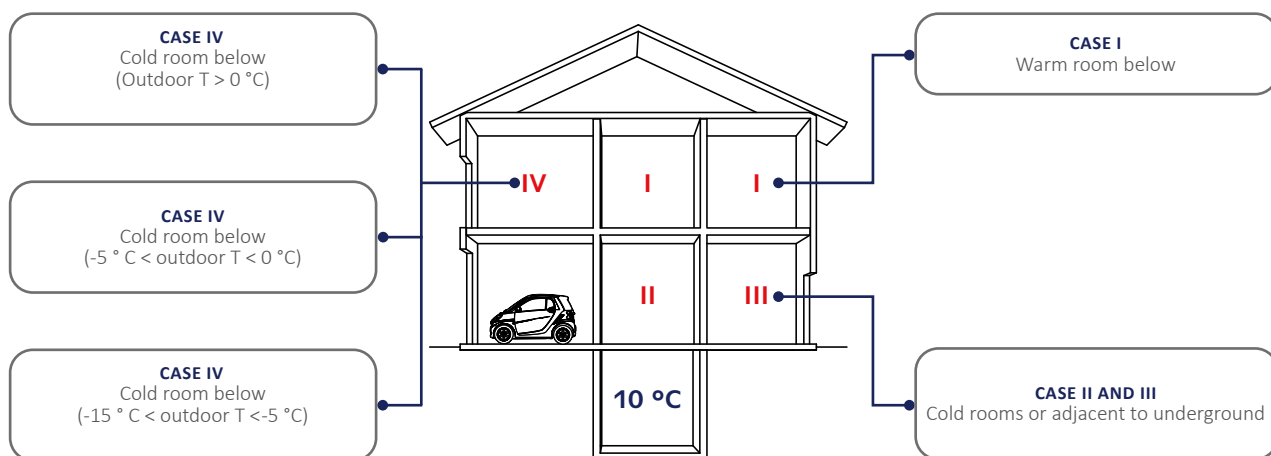

	I	II and III	IV		
	Heated room below	Non-heated room below	Outdoor temperature $> 0\text{ °C}$	Outdoor temperature $-5 / 0\text{ °C}$	Outdoor temperature $-15 / -5\text{ °C}$
Indoor temperature $iT$ (°C)	20	20	20	20	20
Thermal resistance $R\lambda$ ( $\text{m}^2\text{K}/\text{W}$ )	0.75	1.25	1.25	1.50	2.00

### QUALITY LABEL

Nowadays, radiant systems are available on the market among the most efficient systems in terms of flexibility and comfort provided, granting a significant energy saving. These systems are tailored upon the target building and are governed by a wide range of settings.

In this regard, the energy efficiency classification of UNI/TR 11619:2016 and the RSEE index determine the standards to maximize comfort and reduce the consumptions to a minimum.

AAA classification	> 0.98		- 2,172 kWh/year
AA classification	0.94 - 0.98		- 2,064 kWh/year
A classification	0.92 - 0.94		- 1,893 kWh/year
B classification	0.90 - 0.92		- 1,774 kWh/year
C classification	0.88 - 0.90		- 1,648 kWh/year
D classification	< 0.88		- 1,517 kWh/year

**Zone control:**  
a single thermostat installed in the central area of the house.

- Single thermostat
- ON/OFF controller
- Balanced
- EEI > 0.23 circulating pump

Floor sunk panels	0.883	C
Ceiling panels sunk	0.865	D
Wall panels	0.865	D

EFFICIENZA ENERGETICA SISTEMA RADIANTE  
www.q-rad.it

**Single room control:**  
a sensor in each room, installed in the living room, the kitchen, and bedrooms.

- Sensor in each room
- PI or PID controller
- Not balanced
- EEI > 0.23 circulating pump

Floor sunk panels	0.922	A
Ceiling panels sunk	0.904	B
Wall panels	0.904	B

EFFICIENZA ENERGETICA SISTEMA RADIANTE  
www.q-rad.it

**Zone control + climate control:**  
a thermostat installed in the central area of the house connected to an external temperature sensor.

- Single thermostat
- Prop. range P controller 1°C
- Balanced
- EEI ≤ 0.23 circulating pump

Floor sunk panels	0.950	AA
Ceiling sunk panels	0.931	A
Wall panels	0.931	A

EFFICIENZA ENERGETICA SISTEMA RADIANTE  
www.q-rad.it

**Single room control + climate control:**  
a sensor in each room, installed in the living room, the kitchen, and bedrooms, connected to an external temperature sensor.

- Sensor in each room+climate
- PI or PID controller
- Balanced
- EEI ≤ 0.23 circulating pump

Floor sunk panels	0.980	AAA
Ceiling sunk panels	0.960	AA
Wall panels	0.960	AA

EFFICIENZA ENERGETICA SISTEMA RADIANTE  
www.q-rad.it

**TIEMME PARTNERS WITH CASA CLIMA**

CasaClima is an agency operating in South Tyrol. It was established to issue the mandatory energy certification for South Tyrol buildings and has served as an agency for energetic and climate matters since 2014. CasaClima has worked for many years in partnership with leading companies in the quality building sector, in order to promote citizens' awareness on saving energy, sustainability, and climate change.

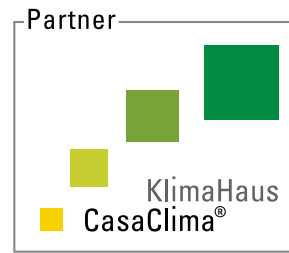

**TIEMME IS ASSOCIATED WITH QRAD**

Q-Rad (Consortium of the Italian Producers of High Quality Radiant Systems) includes some of the most important Italian companies in the sector of heating and cooling systems. The consortium aims to promote, support, and develop awareness on the benefits resulting from radiant systems as a means to increase energy saving and house comfort, applied both to houses and industrial/service-providing buildings.

Consorzio Italiano  
Produttori Sistemi  
Radianti di Qualità



**TIEMME IS KIWA CERTIFIED**

Kiwa Group in Italy verifies the quality of products and processes, and makes personal and environmental performance more transparent. In order to do so, it supports companies, organizations, and governments to meet necessary certification requirements and provides them with testing, inspection, and training. Established in the Netherlands in 1948 as a certifying institute for systems operating with drinking water, Kiwa played a critical role in rebuilding Dutch water network after the Second World War. Since then, it has supervised the quality of public water. Over the years, its activities have extended beyond the "water market" to include any type of market, from constructions to the energy sector, from quality systems to food and drink, medical, environmental, renewable energy, and many other sectors. Nowadays, Kiwa is a new independent, highly experienced organism providing testing, inspection, and certification (TIC), with a global network and working closely with its clients as a "Partner for Progress".



UNI EN ISO 9001:2015

Efesto is software created by Tiemme and designed for all those professionals in need of IT support, aiming to simplify the design of radiant systems, whether they are floor, ceiling or wall installed.

It is extremely easy to use, thus allowing to navigate the wide range of Tiemme solutions and quickly identify the products you need to develop your projects.

The following aspects constitute Efesto's main strengths:

- Fast learning in the design phase;
- Automatic creation of comprehensive lists of materials;
- Possibility to import and export DWG® drawings;
- Possibility to display projects both with top view and vertical section;
- Automatic drawing of coils for radiant floor systems;
- Design of heating and cooling systems.

With Efesto you can develop any project involving radiant systems. In details:

- Apartments, villas, apartment blocks, or other buildings for **residential** purposes;
- Warehouses or other buildings for **industrial** purposes;
- Schools, places of worship, sport centers, or other buildings for **public** purposes;
- Offices, stores or other buildings providing **services**.

Efesto is simple and flexible software and a necessary product for those who want their design process to go one step further.





Tiemme radiant systems offer a comprehensive range of applications that will definitely meet all of your comfort needs in any house.

Each system results from a continuous research of the best technology and materials, in order to provide clients with state of the art solutions in terms of both thermal and/or acoustic insulation and eco-sustainability. However, a system's reliability is as important as its performance.

Tiemme is aware that a radiant system should not raise concerns. That is why reliability is one of its core values and entails a 10 year warranty on Tiemme systems. We are honored to introduce you to **zero10 warranty**.



## 10 YEAR WARRANTY

### RADIANT HEATING/COOLING SYSTEMS

**Tiemme Raccorderie S.p.A.** offers a 10 year warranty on its Cobra-pex Oxistop and Al-Cobrapex pipes and their relevant Tiemme brass accessories used in radiant systems. The warranty is evidenced through the issue of a certificate named: **ZERO10 WARRANTY "Zero Risks for 10 Years!"**. Such certificate is issued exclusively upon specific request of the installer.

a) Customer: \_\_\_\_\_  
Address: \_\_\_\_\_

b) Designer in charge: \_\_\_\_\_  
Address: \_\_\_\_\_

c) Reference project: \_\_\_\_\_

d) Installation venue: \_\_\_\_\_

e) Type of system: \_\_\_\_\_

f) Type of pipes:  CobraPex  CobraPex Oxistop  Al-CobraPex

g) Brass, steel, polyamide accessories: \_\_\_\_\_

h) Installation firm: \_\_\_\_\_  
Address: \_\_\_\_\_

i) Retailer: \_\_\_\_\_

j) Installation end date: \_\_\_\_\_

m) System testing/start-up date: \_\_\_\_\_

**I declare under my personal responsibility that the material has been installed and tested in compliance with the technical instructions given in the manufacturer's technical catalogues and/or in the reference standards and/or project.**

Stamp and signature of the installer: \_\_\_\_\_

Date: \_\_\_\_\_

The warranty is valid only if duly filled in all its parts and sent to TIEMME RACCORDERIE S.p.A. within 30 days from the date of system testing/plant start-up.



0 210-840.802

1/3



ORIGINAL ITALIAN TRADEMARK

Tiemme strongly believes that the a support service for the design phase is critical for installers and professionals. The company also includes a department solely devoted to the design and quote of radiant systems, metering systems, and thermal center. Highly qualified and experienced operators in the field of design listen understand client requirements and guide him to choose the best solution that fits their needs. The system division guarantees adequate support even on any needs that might arise on the site, from controlling the correct functioning to initial system configuration and operation phases. The team organizes work so as to reduce response time to a minimum. The services is offered for free but it is greatly valuable and develops about 5000 projects per year.

Tiemme relies on a long list of specialists working with a wide range of corporate instruments to provide tailored counseling in any phase.





**Tiemme Technical Service (TTS)**, is a service guaranteed by Tiemme and provided thanks to many professional partners collaborating with us to create a competent and available support network.

TTS can satisfy any request concerning Tiemme's sector of operations, from single product installation to operation, testing, maintenance, and repairs of simple and complex systems.

For further information on this service, write to the following e-mail address: [sistemi@tiemme.com](mailto:sistemi@tiemme.com).

**TIEMME, EXCLUSIVE CUSTOMER CARE**

You can find precious information for your job or activity, in "MyTiemme" reserved area of our website. Tiemme has made its catalogs available online for you to read or download at any time. You will also find our technical catalogs, brochures, specifications, certifications, declarations of performance and compliance. You can access them from the page including the details of your desired item.

The platform is supported by any device.

[www.tiemme.com](http://www.tiemme.com)

**DID NOT FIND WHAT YOU WERE LOOKING FOR?**

- Customer service: [customerservice@tiemme.com](mailto:customerservice@tiemme.com)
- After-sales service: [service@tiemme.com](mailto:service@tiemme.com)
- Get a quote: [sistemi@tiemme.com](mailto:sistemi@tiemme.com)
- Tiemme S.p.A: [info@tiemme.com](mailto:info@tiemme.com)
- T +39 030 2142211 - F +39 030 2142206





The training center **Tiemme LAB**, is Tiemme's pride and joy. This important driver of innovation opened in 2012 and unveils for professionals operating in the sector Tiemme's wide range of solutions and an up-to-date selection of new products and technology. Training courses are regularly scheduled to enrich the expertise of professionals operating in the plumbing and heating industry, installation technicians, designers, thermal technicians, architects, and students, who can attend high level courses structured by type of application or designing techniques.



**WHAT IS BIM?**

BIM stands for “Building Information Modeling”, a digital process that takes place over the entire life span of the building (from design to maintenance). It allows to interact with other agents involved in the production chain through a smart digital model, entering and updating our data, reporting our changes or detecting somebody else’s. The purpose is to create a more fluid communication process, avoiding data losses and with real-time updates.

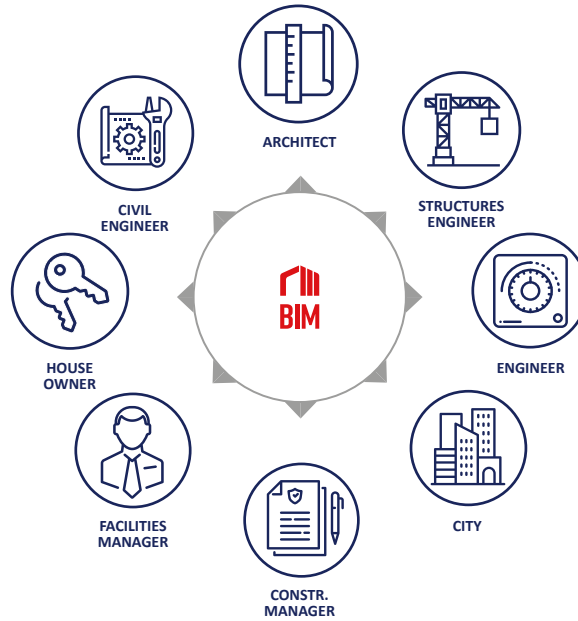
**TIEMME AND BIM**

Tiemme always keeps up with new trends and decided to include its product in the BIM world, so as to provide designers with the best support for their everyday design operations.

Hence, the company created an internal team with qualified personnel checking the quality and functioning of the products developed. If needed, our team can support the designer at any time, starting from the decisional phase, where they provide help to select the best product depending on client requirements, comply with sector-bound regulations, and identify the best approach, right through to actual interventions to solve any issue. BIM TIEMME models imply the use of verified products that match the actual object, thus granting access to the correct size, materials, certifications, and system sizing, in a single solution, without wasting any time looking for information.

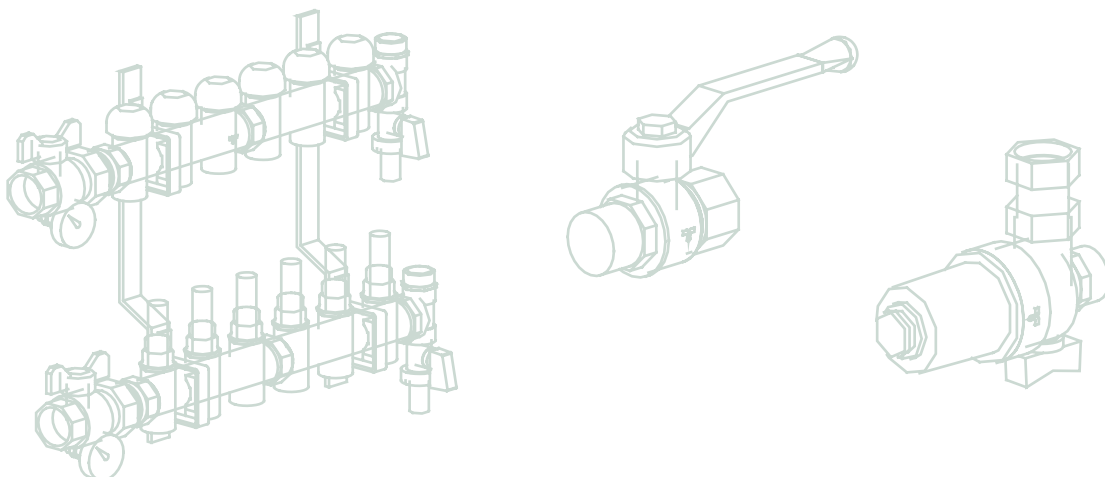



# 01 RADIANT FLOOR SYSTEMS

<b>01A</b>	<b>Why Tiemme radiant floor systems?</b>	16
------------	--	----

<b>01B</b>	<b>“GRAPHITE” systems: why should you use radiant panels with added graphite?</b>	17
------------	---	----

## **01C Thin systems**

	Thin systems - introduction	18
--	-----------------------------	----

	NZEB buildings	19
--	----------------	----

	TIEMME SLIM	20
--	-------------	----

	LOW BLACK	24
--	-----------	----

	DRY	27
--	-----	----

## **01D Systems for residential/service purposes**

	Systems for residential/service purposes - introduction	32
--	---	----

	TRIOLOGY	34
--	----------	----

	NEW CLASSIC GRAPHITE	38
--	----------------------	----

	TECHNO GRAPHITE	42
--	-----------------	----

	CLIP GRAPHITE	46
--	---------------	----

	CLIP SUPER	50
--	------------	----

	SUGHERO	52
--	---------	----

## **01E Soundproofing systems**

	Soundproofing systems - introduction	58
--	--------------------------------------	----

	Acoustic insulation: relevant regulations	59
--	---	----

	SILENTO	60
--	---------	----

# 01A WHY TIEMME RADIANT FLOOR SYSTEMS?

## A BETTER HEAT DIFFUSION

Radiators spread heat by convection, pushing hot air upwards and cold air downwards. With floor heating systems, heat is diffused by radiation, thus granting constant temperature throughout the whole room.

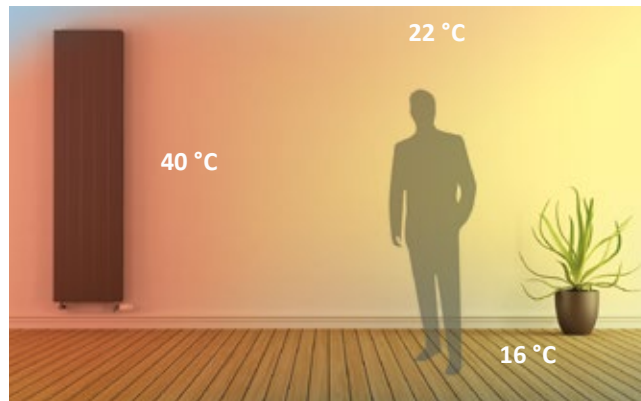

Heating system with radiators

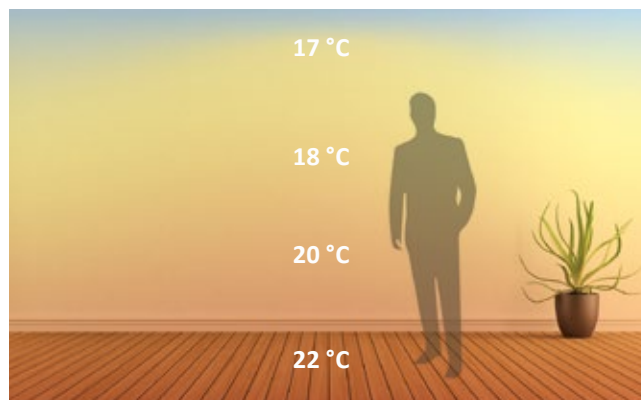

Floor heating system

## SUITABILITY FOR RENEWABLE ENERGY

A heating system relying on radiators requires gas or heating oil to bring water temperature between 70 and 80°C. Floor systems operate at a significantly lower temperature, between 35 and 40°C, thus proving extremely suitable for environmental friendly energy sources like pellet boilers, heat pumps, and solar energy systems.

## REDUCTION OF DUST, MITES, AND MOLD

The presence of radiators facilitates the production of dust, which spread in the environment as a result of convection. With a floor heating system, this issue is significantly reduced, along with the presence of mites and mold.

## ABSOLUTE FREEDOM TO ORGANIZE INTERIORS

Radiators reduce indoor space and impede the use of the walls upon which they are installed. A floor heating system allows to get much space back and use walls entirely.

## ABSOLUTE FREEDOM TO CHOOSE YOUR FLOOR

The radiant system supports any type of floor: from laminate floors to tiles, carpet and terracotta. Wood alone requires much attention, as you need to select a stable and low-sized type of parquet.



# 01B “GRAPHITE” SYSTEMS: WHY SHOULD YOU USE RADIANT PANELS WITH ADDED GRAPHITE?

Graphite is one of the many allotropes of **carbon**.

It has a crystalline structure, with parallel layers of atoms arranged in a hexagonal lattice with a carbon atom at the vertex. Thanks to this peculiar honeycomb structure **graphite particles absorb and reflect stored heat, thus reducing the transfer of heat via radiation to a minimum.**

In order to benefit from this feature, Tiemme decided to provide graphite insulating panels with a higher insulating power:

- **LOW BLACK**
- **DRY**
- **TRILOGY**
- **NEW CLASSIC GRAPHITE**
- **TECHNO GRAPHITE**
- **CLIP GRAPHITE**

Additives allow to decrease the coefficient of thermal conductivity down to 0.030 W/mk, thus complying with UNI EN 1264 standard, with a reduced thickness of the panel's insulating layer.



Renovation is an ideal situation to improve the energy performance of your house, resulting in higher efficiency and savings in terms of system management costs.

Efficient renovation entails the replacement of the heat generator and the old heating system with radiators, with more innovative and high performance solutions.

In compliance to new regulations in force, tax benefits are granted to the taxpayer for this type of interventions. From a structural perspective, the following interventions should be considered: structural strengthening, moisture content of masonry walls, replacement of windows and doors, reduction of surcharges on slabs, and seismic upgrading.

The wide range of TIEMME radiant solutions includes floor or ceiling heating and cooling systems tailored upon any specific needs of the buildings undergoing renovation.

Our main goal is to create a system that is perfectly integrated in the environment, now more than ever.



## TIEMME FOR ENERGY RENOVATION AND REDEVELOPMENT

### TIEMME SOLUTIONS

#### TIEMME SLIM



#### LOW BLACK

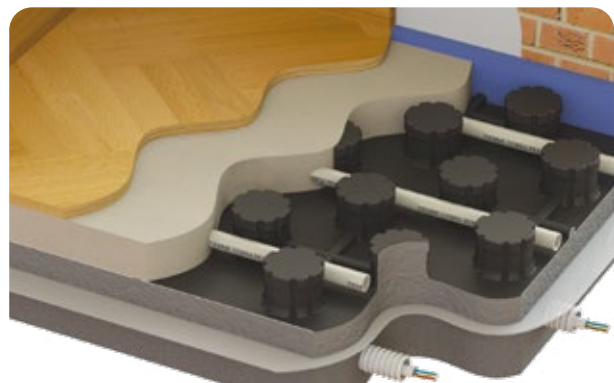

#### DRY





For buildings designed with high quality standards in terms of thermal insulation, in compliance with European directives requiring by 2020 the construction of “almost zero energy” buildings, a (low thermal inertia) radiant wall, ceiling or floor system, is the ideal solution for a winter and summer climate control. A house complying with current energy standards is characterized by:

- reduced energy supply needs for winter and summer climate control;
- occasional and limited need for power.

Radiant systems with thin screeds are the best possible solution, due to their low thermal inertia and reduced time needed for a full implementation.



Regulatory provisions are very clear and, as a consequence, the world of renovation and redevelopment tends to create low-consumption and high-performance buildings. For this reason, TIEMME provides a wide range of heating and cooling floor and ceiling systems that meet the specific needs of new buildings and renovation interventions. Tiemme technical team is ready to accommodate any request, suggesting the right system according to project specifications.

## ASSESSING INERTIA IN RADIANT SYSTEMS

In physics and mechanics, inertia is an object's amount of resistance to a change in motion, which is quantified by its inertial mass.

It is difficult to apply this concept to radiant systems, as there are many concurrent conditions impacting on their performance.

Factors affecting a system's inertia include:

- Inertial temperature
- Room temperature in the environment requiring climate control
- The system's position (interstorey or in contact with the outside)

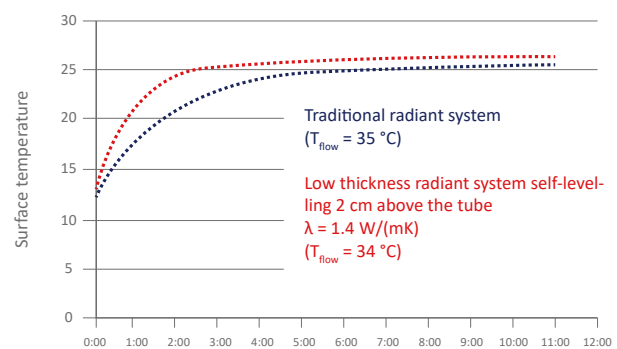

A quick and precise method to assess inertia is by making dynamic simulations of finished elements on system sections. The picture on the side shows an example of the outcomes, with the surface temperature to time of two radiant systems. It takes less than 30 minutes to the thin system (in red) to achieve the desired surface temperature. A traditional system consisting of an insulator and concrete screed needs a higher range of time to achieve the superficial temperature. It is worth to consider this aspect when designing the system control, to guarantee the achievement of desired temperature within 24 hours. Thermal inertia is also important when shutting down the system: a low inertia system needs less time to cool down compared to a traditional system. Radiant systems with thin screeds and, as a consequence, low thermal inertia enable to control the environment in a very effective way and are compatible with new low-consumption buildings.

TIEMME SLIM is the new Tiemme system designed to meet the demand for low thermal inertia and thin radiant systems. Designed to satisfy system requirements in renovation processes, it is thin and can be bonded on the existing floor, thus enabling to create a system without any need for demolitions.

It supports 16x2mm and 17x2mm diameter pipes, with an excellent flow rate in both winter and summer, with a low pressure drop, thus optimizing the pump. The optimized ashlar guarantees perfect contact between the pipes and the screed, increasing system performance and enabling diagonal 45° laying without fastening clips. The molded thermoformed-polystyrene foil shows high resistance to impact, thus optimizing laying on the construction site. Available in a version with insulator.

### SELF ADHESIVE TIEMME SLIM (PANEL CODE 450 0641)

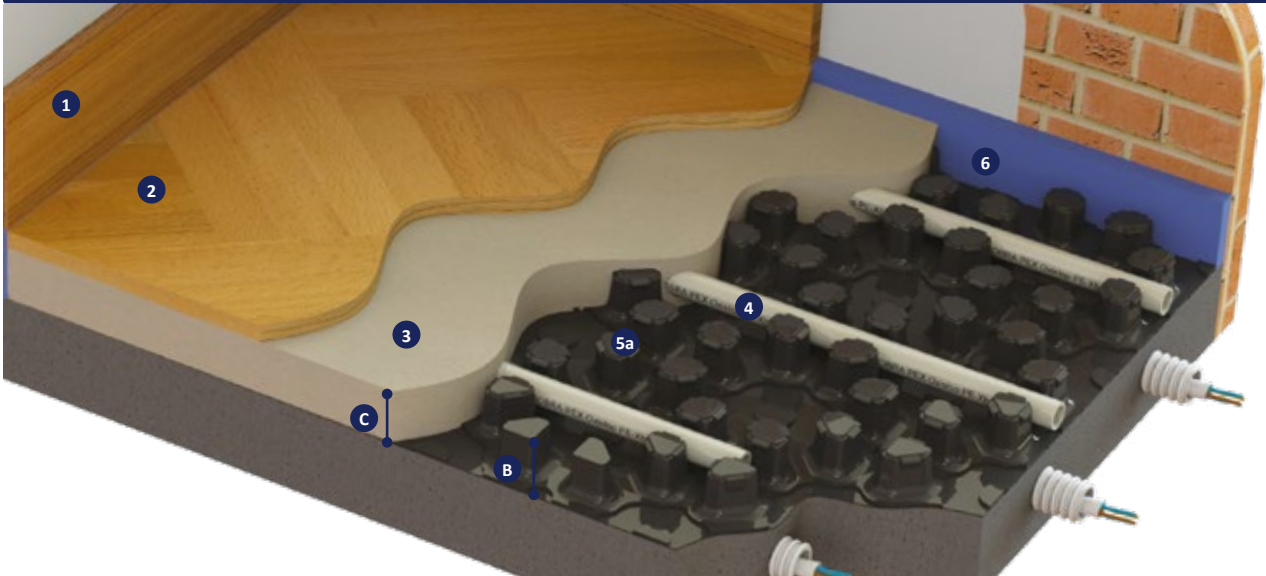

### TIEMME SLIM WITH INSULATOR (PANEL CODE 450 0642)



- |                             |               |
|-----------------------------|---------------|
| 1. Skirting                 | -             |
| 2. Coating                  | -             |
| 3. Lowered screed           | -             |
| 4. Pipe                     | art. 0200B    |
| 5. (5a) Self adhesive panel | code 450 0641 |
| (5b) Insulating panel       | code 450 0642 |
| 6. Perimetral band          | art. 4507     |
| 7. PE strip                 | art. 4503     |

Code	Size (mm)		
	A	B	C
450 0641	-	19	23.6 ÷ 38.6 (*)
450 0642	5	23.6	33.6 ÷ 43.6 (*)

(\*) According to the screed used  
See paragraph "Guide to the creation of the screed" on the next page.



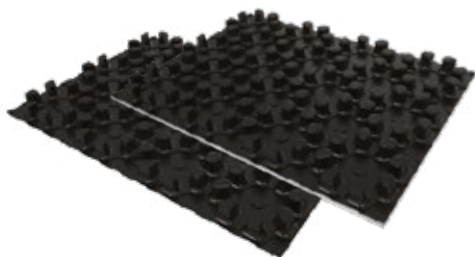

### 4519

Thermoformed panel without thermal insulation with self-adhesive surface or 5mm EPS 200 insulator, with embossed ashlar to block the pipe, even at 45°. Designed specifically for renovations.

Code	Insulating thickness (mm)	Total thickness (mm)	Price €/m <sup>2</sup>	Unit/Box (m <sup>2</sup> )	Unit/Box (no. panels)
450 0641	-	19		17.92	16
450 0642	5	23.6		22.40	20

### TECHNICAL SPECIFICATIONS

	Codes	
	450 0641	450 0642
Panel size (mm)	1400 x 800 Self-adhesive surface	1400 x 800
Insulating thickness (mm)	-	5
Ashlar thickness (mm)	18	18
Panel total thickness (mm)	19	23.6
Pipe thickness (mm)	16 - 17	16 - 17
Minimum pipe distance [mm]	50 (90° laying) - 71 (45° laying)	50 (90° laying) - 71 (45° laying)
Thermal resistance on effective average thickness R <sub>λ,ins</sub> (m <sup>2</sup> K/W)	-	0.15
PS thermoformed foil thickness (mm)	1	0.6
Claimed thermal conductivity (W/mk)	-	0.034
Euroclass reaction to fire EN 13501-1	E	E
Panels per pack (n)	16	20
Panel surface per pack (m <sup>2</sup> )	17.92	22.40

### GUIDE TO THE CREATION OF THE SCREED

When the screed, which forms an integral part of the radiant section, fully wraps the pipes, this guarantees optimal heat transfer by conduction, thus resulting in the ideal outcome of Tiemme SLIM radiant system. A good screed should enable to level surfaces, distribute surcharges evenly, it should constitute a good base for flooring and a good container for floor heating system. Tiemme recommends to use the following KNAUF mixes with the innovative Tiemme SLIM system: NE 499 for screeds lifting up to 5/10 mm over the ashlar, NE 425 for screeds lifting up to 20 mm over the ashlar. NOTE: If you are employing a self leveling screed, follow the provider instructions.

Knauf screed		Codes	
		450 0641	450 0642
NE 499 - 5/10 mm thickness λ = 1,3 W/(mk)	Panel thickness	19 mm	23.6 mm
	Panel + screed thickness	24/29 mm	33.6 mm
NE 425 - 20 mm thickness λ = 1,4 W/(mk)	Panel thickness	19 mm	23.6 mm
	Panel + screed thickness	39 mm	43.6 mm



### 0200B

COBRAPEX cross-linked polyethylene high density pipe with EVOH anti-oxygen barrier.

#### TECHNICAL SPECIFICATIONS

- Max operating temperature: 95 °C
- Thermal conductivity: 0,38 W/mk
- EN ISO 15875-2 compliant
- EVOH, DIN 4726 compliant anti-oxygen barrier
- Composition: PE-Xb

Code	Type	Price €/m	Pack (m)
020 0005	16 x 2.0		120/3240
020 0018	16 x 2.0		200/3600
020 0003	16 x 2.0		300/3600
020 0001	16 x 2.0		600/3000
020 0008	17 x 2.0		120/3240
020 0071	17 x 2.0		200/3200
020 0006	17 x 2.0		300/2700
020 0002	17 x 2.0		600/3000



### 4507

Perimetral band in PE foam with adhesive back and mortar containment PE sheet.

 Precut H = 100 mm

Code	Type	Price €/m	Pack (m)
450 0443	H 150 x 5 mm		50/250
450 0007	H 150 x 8 mm		25/125



### 1480P

90° plastic elbow to protect and support COBRAPEX pipe near the connection to the distribution manifold.

Code	Type	Price €	Unit/Box
034 0077	Pipe Ø 14 - 18		25/200

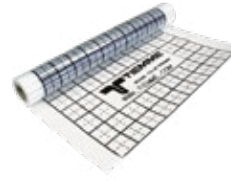

### 4503

PE moisture-proof insulating strip

#### TECHNICAL SPECIFICATIONS

- Width: 1.2 m
- Length: 100 m
- Thickness: 0.15 mm

Code	Type	Price €/m <sup>2</sup>	Unit/Box (m <sup>2</sup> )
450 0025	-		120/120



### 4539

Protects against the corrosion of metal particles with universal bactericide and fungicide for heating and cooling systems.

#### TECHNICAL SPECIFICATIONS

- Dose: 1 l additive x 100 l circulating water

Code	Type	Price €	Unit/Box
450 0486	1 l		1/12



Tiemme radiant technology and Knauf expertise with screeds create:



the innovative TIEMME SLIM system, certified for Qk concentrated vertical loads by Elletipi S.r.l. laboratory, with NE 499 and NE 425 Knauf 5 mm mortars.

## RENOVATION WILL NO LONGER BE A PROBLEM



### ADHESIVE FILM

No unwanted movements and demolitions



### THERMOFORMED ASHLAR

Extremely easy to lay



### LOW THERMAL INERTIA



### REDUCED THICKNESS

Complete in only 24 mm

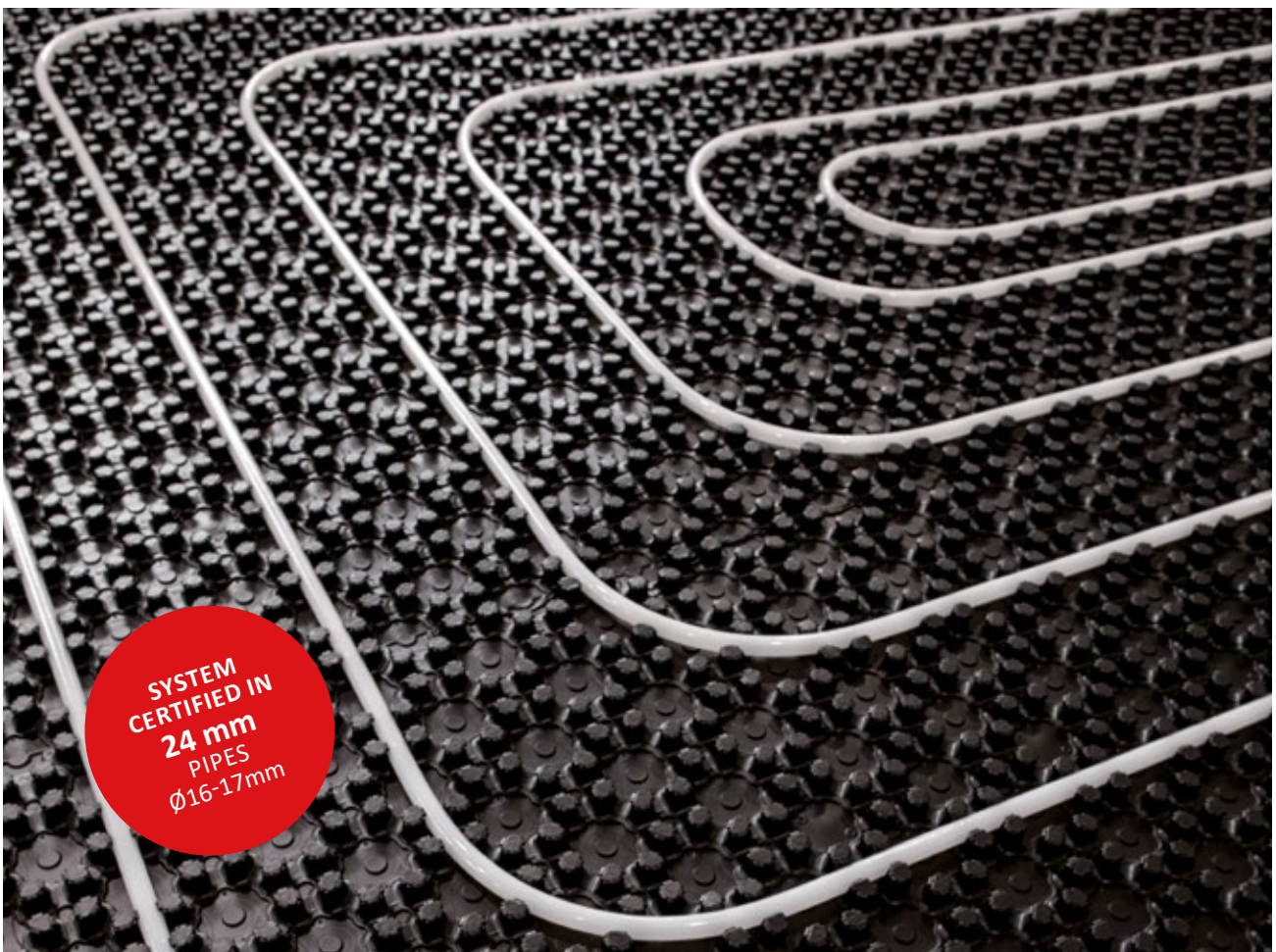

SYSTEM  
CERTIFIED IN  
**24 mm**  
PIPES  
Ø16-17mm

Low Black is the new Tiemme system designed to meet the demand for low-thermal-inertia radiant systems. Available in different degrees of thickness, thus enabling applications both in new buildings, with UNI EN 1264 compliant values of thermal resistance, and renovations, when reduced system size is a priority. Made in high mechanical strength (EPS 300) graphite sintered polystyrene foam, it is suitable for special lowered screeds down to 10mm over the pipes. The panel has a protective layer in HIPS 170 µm heat-sealed polystyrene, in compliance with regulations in force. It supports Ø16x2 - 17x2 pipes, guarantees a high flow and reduced load losses.

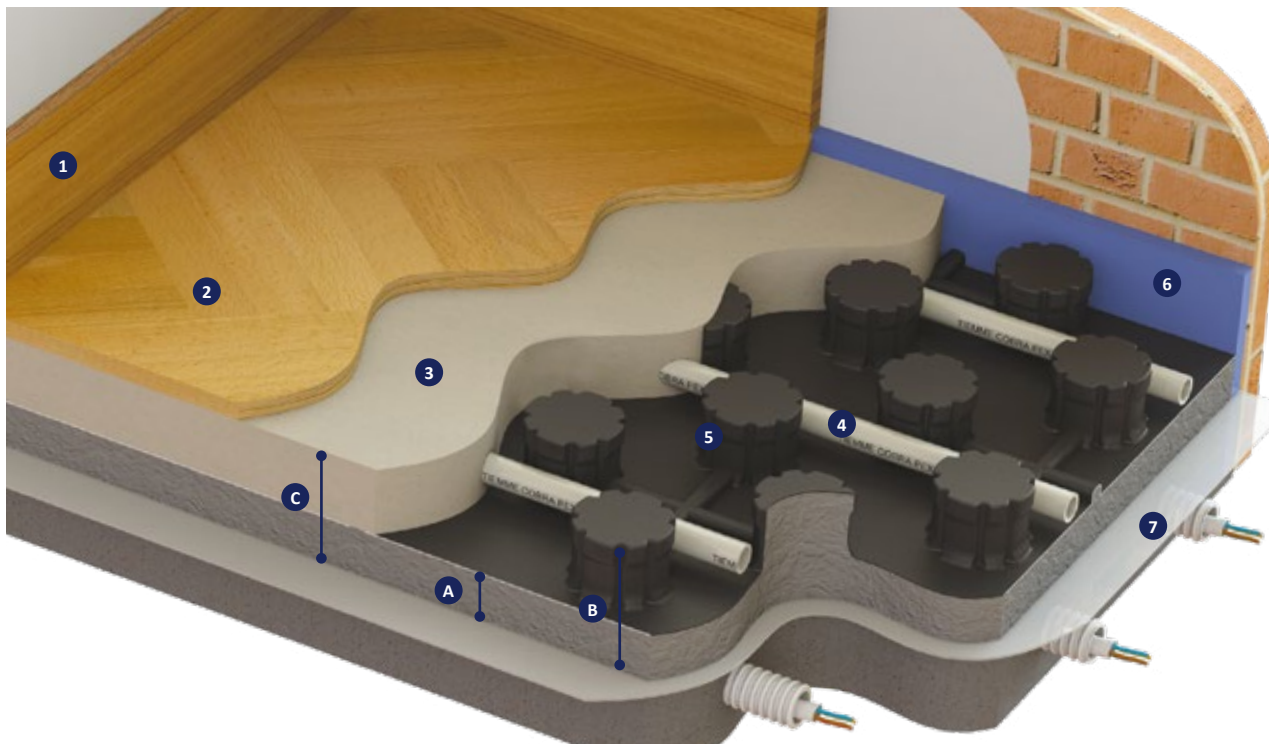

- |                     |              |
|---------------------|--------------|
| 1. Skirting         | -            |
| 2. Coating          | -            |
| 3. Screed           | -            |
| 4. Pipe             | art. 0200B   |
| 5. Insulating panel | art. 4518GRF |
| 6. Perimetral band  | art. 4507    |
| 7. PE strip         | art. 4503    |

Code	Size (mm)		
	A	B	C
450 0567	12	31	41 ÷ 51
450 0568	19	38	48 ÷ 58
450 0569	34	53	63 ÷ 73

### UNI EN 1264 COMPLIANT THICKNESS\*

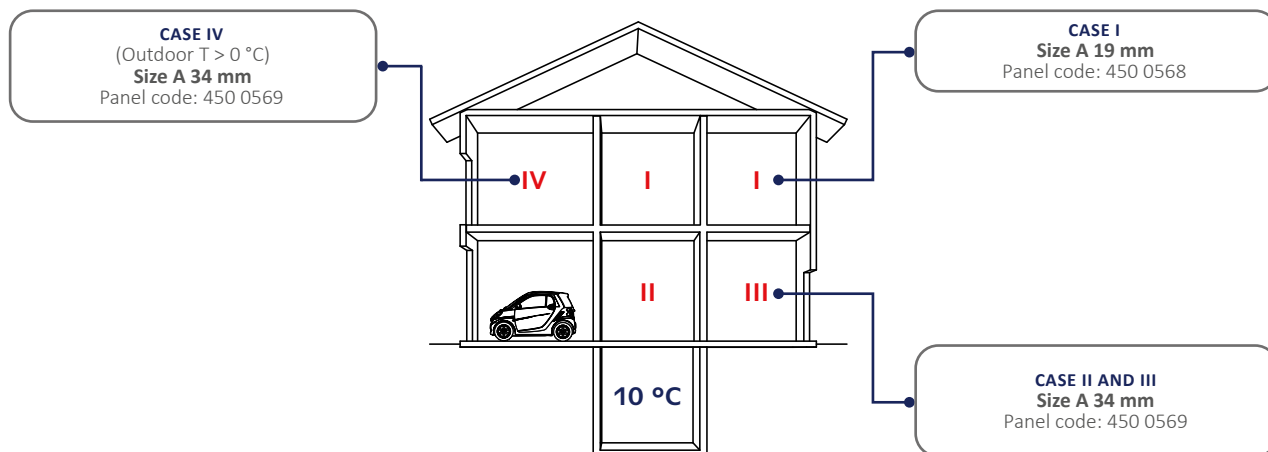

\* To obtain the thermal resistance value required by the UNI EN 1264 standard, it is possible to add an insulating mat.



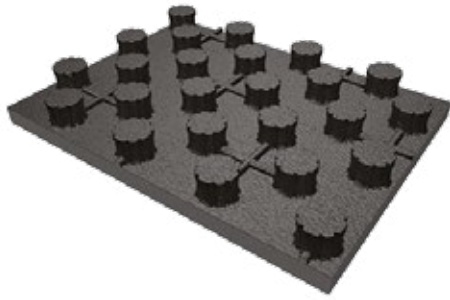

### 4518GRF

Insulating panel for radiant floor systems, made in closed-cell sintered foam polystyrene, with a graphite additive and a HIPS 170 µm protective heat-sealed foiled polystyrene layer, EC certified and suitable for radiant systems supplied with water for integrated cooling and heating systems in buildings complying with UNI EN 1264 standard.

Code	Insulating thickness (mm)	CS 10% (kPa)	Price €/m <sup>2</sup>	Unit/Box (m <sup>2</sup> )	Unit/Box (no. panels)
450 0567	12	300		23.52/94.08	21
450 0568	19	300		17.92/71.68	16
450 0569	34	300		12.32/49.28	11

### TECHNICAL SPECIFICATIONS

	Codes		
	450 0567	450 0568	450 0569
Thermal resistance EN 13163 (m <sup>2</sup> k/W)	0.55	0.77	1.26
10% compressive resistance UNI EN 826 (kPa)	300		
Insulating thickness (mm)	12	19	34
Total thickness (mm)	31	38	53
<b>Total equivalent thickness UNI EN 1264/3 (mm)</b>	<b>17</b>	<b>24</b>	<b>39</b>
Coating film (µm)	170		
Minimum pipe distance [mm]	50		
Heat conductivity UNI EN 12667 (W/mK)	0.031		
Water absorption UNI EN 12087 (%)	5		
Euroclass reaction to fire EN 13501-1	E		
Panel total size (mm)	1425 x 825		
Usable panel size (mm)	1400 x 800		
Usable panel surface (m <sup>2</sup> )	1.12		
Panels per pack (n)	21	16	11
Panel surface per pack (m <sup>2</sup> )	23.52	17.92	12.32



### 0200B

COBRAPEX cross-linked polyethylene high density pipe with EVOH anti-oxygen barrier.

#### TECHNICAL SPECIFICATIONS

- Max operating temperature: 95 °C
- Thermal conductivity: 0,38 W/mk
- EN ISO 15875-2 compliant
- EVOH, DIN 4726 compliant anti-oxygen barrier
- Composition: PE-Xb

Code	Type	Price €/m	Unit/Box (m)
020 0005	16 x 2.0		120/3240
020 0018	16 x 2.0		200/3600
020 0003	16 x 2.0		300/3600
020 0001	16 x 2.0		600/3000
020 0008	17 x 2.0		120/3240
020 0071	17 x 2.0		200/3200
020 0006	17 x 2.0		300/2700
020 0002	17 x 2.0		600/3000



### 4507

Perimetral band in PE foam with adhesive back and mortar containment PE strip.

 Precut H = 100 mm

Code	Type	Price €/m	Unit/Box (m)
450 0443	H 150 x 5 mm		50/250
450 0007	H 150 x 8 mm		25/125



### 1480P

90° plastic elbow to protect and support COBRAPEX pipe near the connection to the distribution manifold.

Code	Type	Price €	Unit/Box
034 0077	Pipe Ø 14 - 18		25/200



### 4503

PE moisture-proof insulating strip

#### TECHNICAL SPECIFICATIONS

- Width: 1.2 m
- Length: 100 m
- Thickness: 0.15 mm

Code	Type	Price €/m <sup>2</sup>	Unit/Box (m <sup>2</sup> )
450 0025	-		120/120



### 4539

Protects against the corrosion of metal particles with universal bactericide and fungicide for heating and cooling systems.

#### TECHNICAL SPECIFICATIONS

- Dose: 1 l additive x 100 l circulating water

Code	Type	Price €	Unit/Box
450 0486	1 l		1/12





Dry is the new Tiemme dry system designed to meet the demand for low-thermal-inertia dry radiant systems. Available in different degrees of thickness, thus enabling applications both in new buildings, with UNI EN 1264 compliant values of thermal resistance, and renovations, when reduced system size is a priority. Quick laying, no downtime for letting the screed dry. High thermal conductivity, due to the 0.15 mm aluminum foil pre-assembled with the EPS panel. Available with 150mm and 100mm distance, for maximum performance both in winter and summer. Made in high mechanical strength (EPS 300) graphite sintered polystyrene foam, it is suitable for 16x2mm pipes and guarantees a high flow rate and reduced pressure drop. Ceramic floor can be bonded directly onto the panel, by protecting them with the aluminum foil primer. When using wood, we recommend to lay a floating floor or bond with a specific lowered concrete mortar.

### DRY - BONDED CERAMIC LAYING

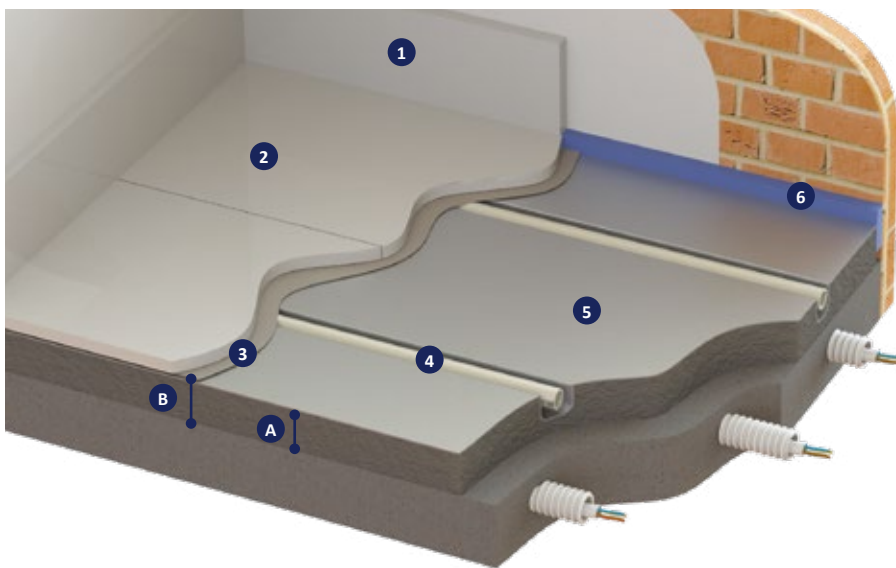

- 1. Skirting -
- 2. Ceramic coating -
- 3. Glue -
- 4. Pipe **art. 0200B**
- 5. Insulating panel **art. 4517GRF**
- 6. Perimetral band **art. 4507**

Code	Size (mm)	
	A	B
450 0562	26	29
450 0564	26	29
450 0563	42	45
450 0565	42	45

### DRY - BONDED PARQUET LAYING

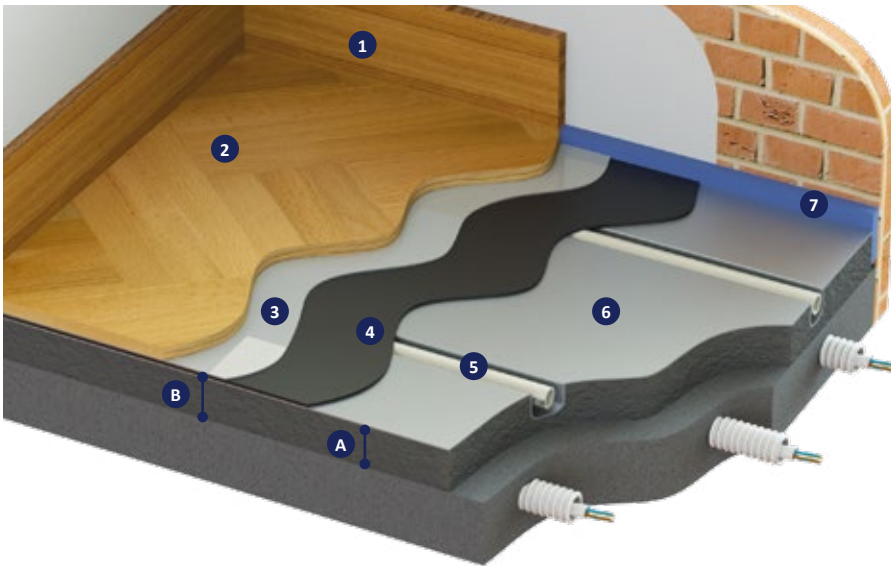

1. Skirting
2. Bonded parquet coating
3. Glue
4. Carpet (Isolmant Isoltile AD)
5. Pipe
6. Insulating panel
7. Perimetral band

-  
-  
-  
-  
art. 0200B  
art. 4517GRF  
art. 4507

Code	Size (mm)	
	A	B
450 0562	26	30
450 0564	26	30
450 0563	42	46
450 0565	42	46

### DRY - FLOATING PARQUET LAYING

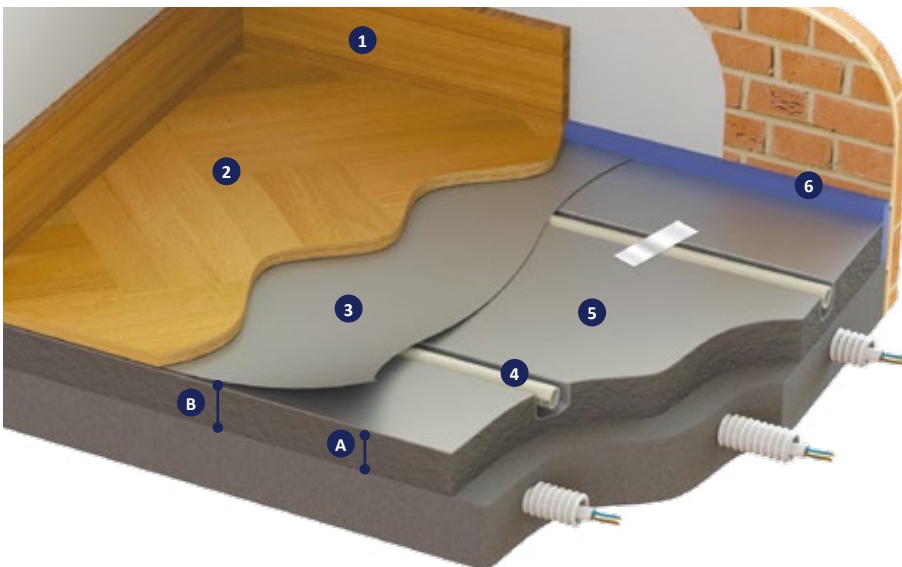

1. Skirting
2. Floating parquet coating
3. Separation layer (Isolmant TOP)
4. Pipe
5. Insulating panel
6. Perimetral band

-  
-  
-  
art. 0200B  
art. 4517GRF  
art. 4507

Code	Size (mm)	
	A	B
450 0562	26	28
450 0564	26	28
450 0563	42	44
450 0565	42	44



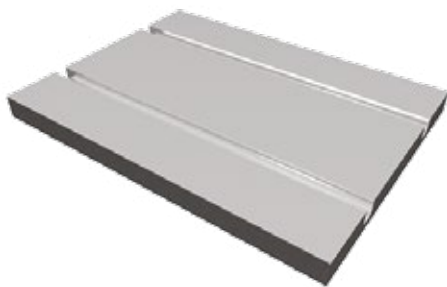

### 4517GRF

Insulating panel for radiant dry floor systems in EPS 300, with graphite, pre-bonded to 1050 aluminum alloy foil with high thermal conductivity. Low thermal inertia due to the absence of the screed, enabling short response time. Ideal for heating and cooling systems and available with 100 or 150 mm laying distance.



Code	Thickness (mm)	Spacing (mm)	CS 10% (kPa)	Price €/m <sup>2</sup>	Unit/Box (m <sup>2</sup> )	Unit/Box (no. panels)
450 0562	26	100	300		11.20/89.60	10
450 0563	42	100	300		6.72/53.76	6
450 0564	26	150	300		10.5/84	10
450 0565	42	150	300		6.30/50.40	6

### TECHNICAL SPECIFICATIONS

	Codes			
	450 0562	450 0563	450 0564	450 0565
Insulating thickness (mm)	26	42	26	42
<b>Total thickness (mm)</b>	<b>26</b>	<b>42</b>	<b>26</b>	<b>42</b>
Aluminum alloy/ thickness (mm)	1050/ 0.15			
Claimed thermal conductivity (W/mk)	0.031			
<b>Thermal resistance R<sub>λ,ins</sub> (m<sup>2</sup>k/W)</b>	<b>0.75</b>	<b>1.27</b>	<b>0.75</b>	<b>1.26</b>
10% deflection compressive resistance (kPa)	300			
Euroclass reaction to fire	E			
Panel total size (mm)	1400 x 800		1400 x 750	
Minimum pipe distance [mm]	100		150	
Usable panel surface (m <sup>2</sup> )	1.12		1.05	

### UNI EN 1264 COMPLIANT THICKNESS\*

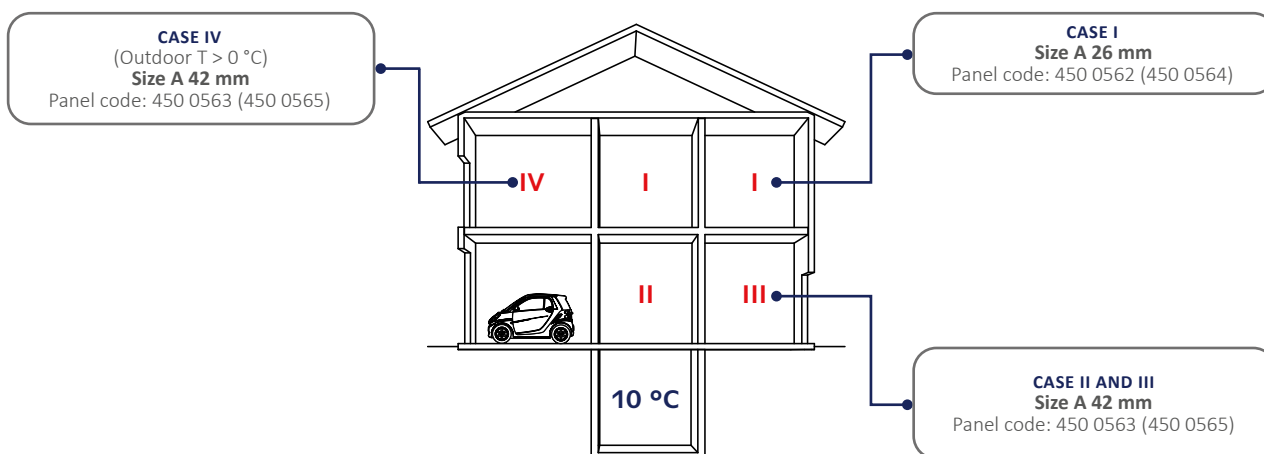

\* To obtain the thermal resistance value required by the UNI EN 1264 standard, it is possible to add an insulating mat.



### 0200B

COBRAPEX cross-linked polyethylene high density pipe with EVOH anti-oxygen barrier.

#### TECHNICAL SPECIFICATIONS

- Max operating temperature: 95 °C
- Thermal conductivity: 0,38 W/mk
- EN ISO 15875-2 compliant
- EVOH, DIN 4726 compliant anti-oxygen barrier
- Composition: PE-Xb

Code	Type	Price €/m	Unit/Box (m)
020 0005	16 x 2.0		120/3240
020 0018	16 x 2.0		200/3600
020 0003	16 x 2.0		300/3600
020 0001	16 x 2.0		600/3000



### 4507

Perimetral band in PE foam with adhesive back and mortar containment PE strip.

 Precut H = 100 mm

Code	Type	Price €/m	Unit/Box (m)
450 0443	H 150 x 5 mm		50/250
450 0007	H 150 x 8 mm		25/125



### 1480P

90° plastic elbow to protect and support COBRAPEX pipe near the connection to the distribution manifold.

Code	Type	Price €	Unit/Box
034 0077	Pipe Ø 14 - 18		25/200



### 4517NA

Reinforced aluminum adhesive tape

#### TECHNICAL SPECIFICATIONS

- Width: 50 mm
- Length: 50 m
- Thickness: 30 µm

Code	Type	Price €	Unit/Box
450 0566	-		1/24



### 4539

Protects against the corrosion of metal particles with universal bactericide and fungicide for heating and cooling systems.

#### TECHNICAL SPECIFICATIONS

- Dose: 1 l additive x 100 l circulating water

Code	Type	Price €	Unit/Box
450 0486	1 l		1/12



Radiant technology developed by



and our expertise on the field create the innovative system DRY, suitable for both cooling and heating systems.

## IDEAL FOR NEW HIGH-EFFICIENCY BUILDINGS AND RENOVATIONS



### REDUCED TIME

The system is fully operational in less than one hour



### QUICK LAYING

No downtime for the screed to dry



### LOW THERMAL INERTIA



### REDUCED THICKNESS



**EXTREMELY  
RAPID!  
FULLY OPERATIONAL  
IN LESS  
THAN 1h**

## GUIDE TO SELECT THICKNESS ACCORDING TO UNI EN 1264

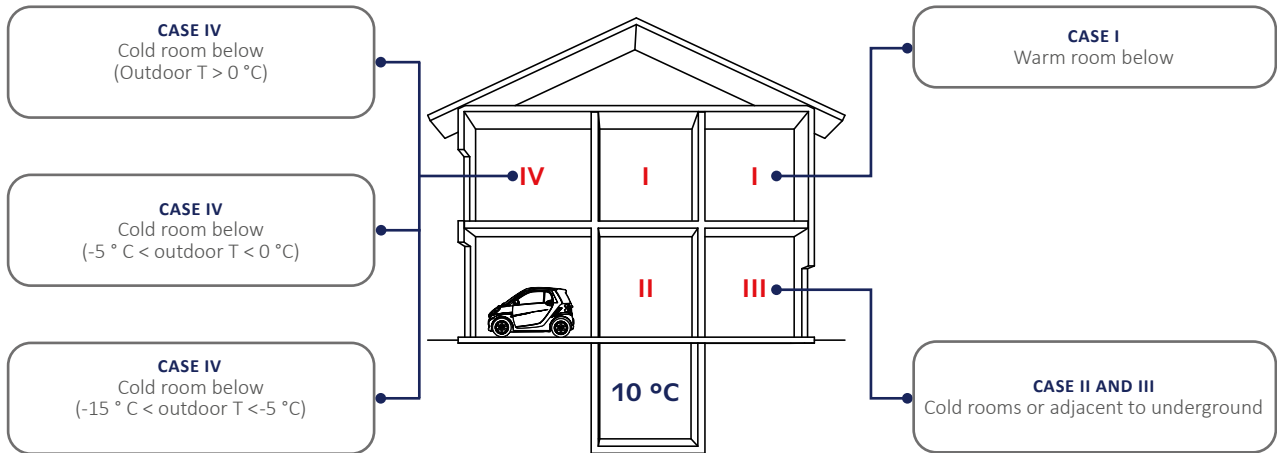

	$R_D$ (m <sup>2</sup> K/W)	Minimum total equivalent thickness required (mm)			
		Polyurethane $\lambda_0 = 0.023$ (W/mK)	EPS with graphite $\lambda_0 = 0.030$ (W/mK)	EPS $\lambda_0 = 0.035$ (W/mK)	Cork $\lambda_0 = 0.044$ (W/mK)
CASE I	0.75	17.5	22.5	26.5	33
CASES II and II	1.25	29	37.5	44	55
CASE IV (outdoor T > 0 °C)	1.25	29	37.5	44	55
CASE IV (-5 °C < outdoor T < 0 °C)	1.50	34.5	45	53	66
CASE IV (-15 °C < outdoor T < -5 °C)	2.00	46	60	70	88



## TIEMME SOLUTIONS

TRILOGY

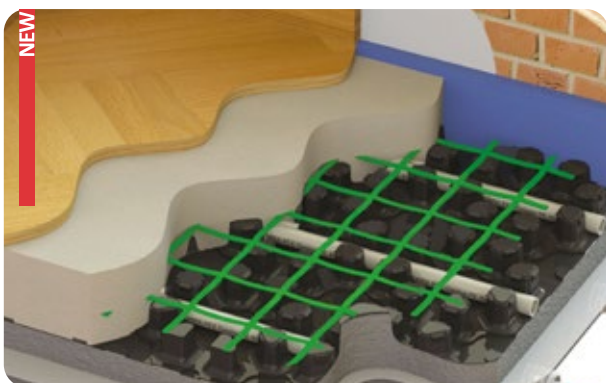

CLIP GRAPHITE

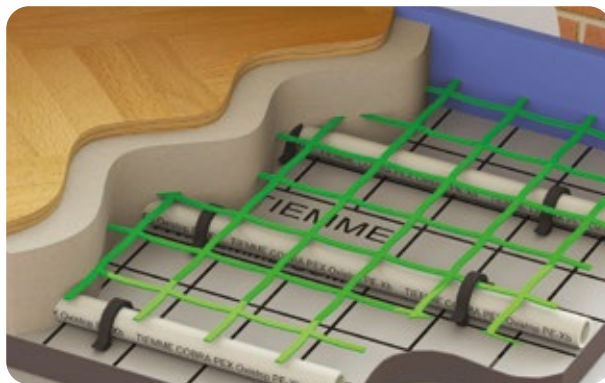

NEW CLASSIC GRAPHITE



CLIP SUPER

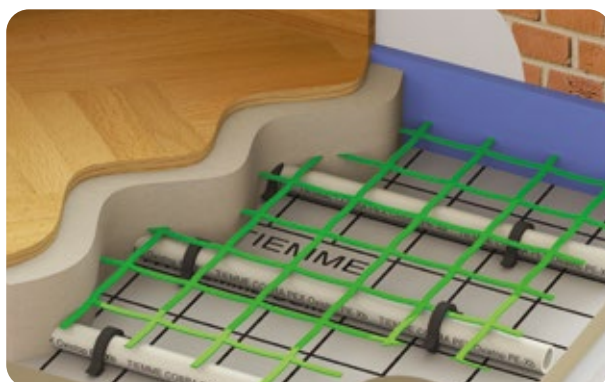

TECHNO GRAPHITE



SUGHERO



The ideal solution for residential and commercial cooling and heating systems. Thanks to a limited height of the ashlar (18 mm) the global size of the system is limited, comparing to traditional systems with 22 mm ashlar.

**The reduced height of the ashlar becomes fundamental in the last review of Standard UNI EN 1264-3, which doesn't consider the ashlar when calculating the thermal resistance value.**

Thanks to this 4 mm lower panel (18 mm instead of 22), TRILOGY allows to keep the global thickness unchanged, with the same thermal resistance value.

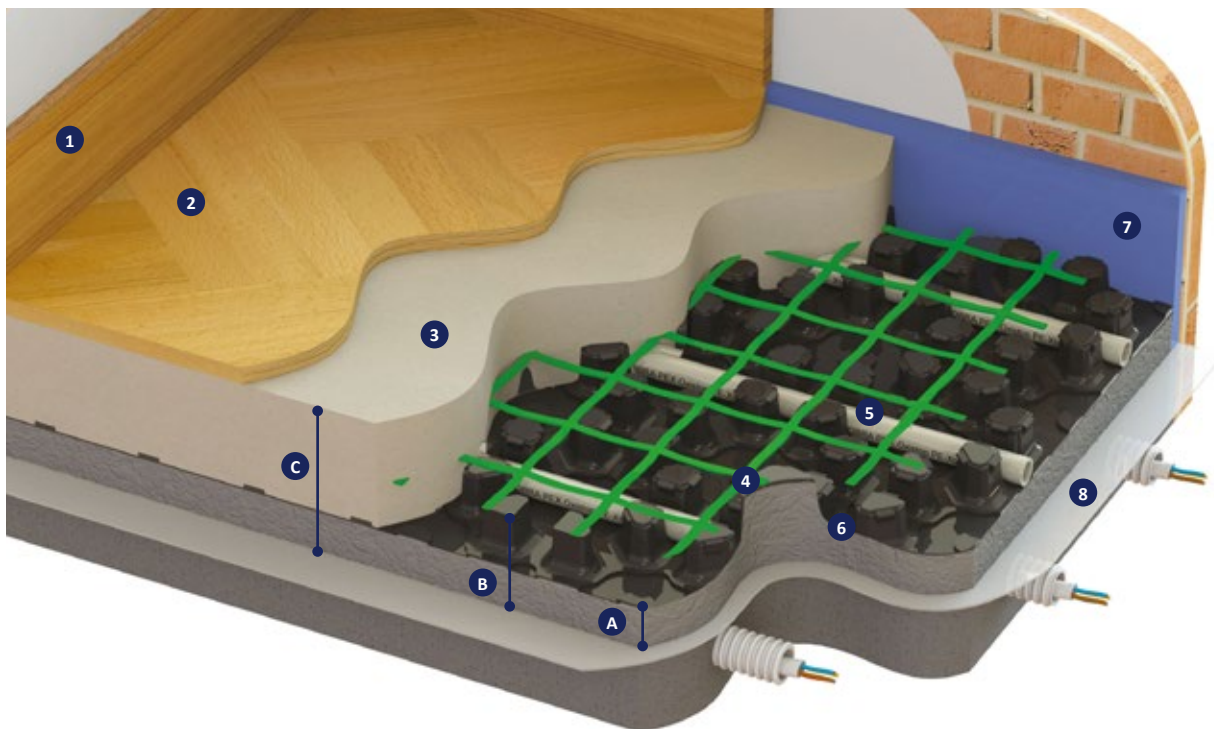

- 1. Skirting -
- 2. Coating -
- 3. Screed -
- 4. Fiberglass mesh art. 4532
- 5. Pipe art. 0200B
- 6. Insulating panel art. 4514PANGRF
- 7. Perimetral band art. 4507
- 8. PE strip art. 4503

Code	Size (mm)		
	A	B	C
450 0691	10	28	60 ÷ 70
450 0692	23	41	73 ÷ 83
450 0693	38	56	88 ÷ 98
450 0694	45	63	95 ÷ 105
450 0695	60	78	110 ÷ 120

### UNI EN 1264 COMPLIANT THICKNESS

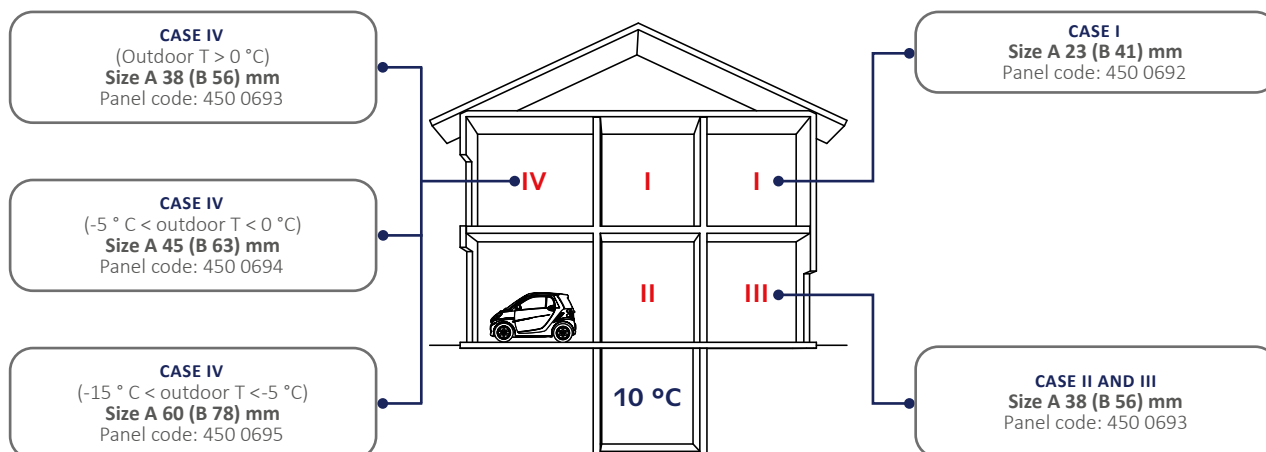



NEW



### 4514PANGRF

Thermoformed panel with ashlar made in foam polystyrene, sintered with graphite and bonded to a hard black polystyrene black foil with ashlar. In compliance with EN 13163 standard, it has embossed details to fasten the pipe (50 mm distance / 70 mm 45° laying) and male-female connections for a firm joint. The rigid strip lends the panel higher resistance to wear and impact. Perimetral male-female connections allow to overlap strips and make it suitable for liquid self leveling screeds. Limited ashlar height: only 18 mm.

Code	Insulating thickness (mm)	CS 10% (kPa)	Price €/m <sup>2</sup>	Unit/Box (m <sup>2</sup> )	Unit/Box (no. panels)
450 0691	10	200		24.64	22
450 0692	23	150		14.56	13
450 0693	38	150		10.08	9
450 0694	45	150		8.96	8
450 0695	60	150		6.72	6

### TECHNICAL SPECIFICATIONS

	Codes				
	450 0691	450 0692	450 0693	450 0694	450 0695
Thermal resistance EN 13163 (m <sup>2</sup> k/W)	0.33	0.77	1.27	1.50	2.00
10% compressive resistance UNI EN 826 (kPa)	200	150	150	150	150
Insulating thickness (mm)	10	23	38	45	60
Total thickness (mm)	28	41	56	63	78
Rigid covering foil (mm)	0.65				
Minimum pipe distance [mm]	50 (70 mm 45° laying)				
Heat conductivity UNI EN 12667 (W/mK)	0,030				
Water absorption UNI EN 12087 (%)	6.5	4.0	4.0	4.0	4.0
Euroclass reaction to fire EN 13501-1	E				
Panel total size (mm)	1450 x 850				
Usable panel size (mm)	1400 x 800				
Usable panel surface (m <sup>2</sup> )	1,12				
Panels per pack (n)	22	13	9	8	6
Panel surface per pack (m <sup>2</sup> )	24.64	14.56	10.08	8.96	6.72



### 0200B

COBRAPEX cross-linked polyethylene high density pipe with EVOH anti-oxygen barrier.

#### TECHNICAL SPECIFICATIONS

- Max operating temperature: 95 °C
- Thermal conductivity: 0,38 W/mk
- EN ISO 15875-2 compliant
- EVOH, DIN 4726 compliant anti-oxygen barrier
- Composition: PE-Xb

Code	Type	Price €/m	Unit/Box (m)
020 0005	16 x 2.0		120/3240
020 0018	16 x 2.0		200/3600
020 0003	16 x 2.0		300/3600
020 0001	16 x 2.0		600/3000
020 0008	17 x 2.0		120/3240
020 0071	17 x 2.0		200/3200
020 0006	17 x 2.0		300/2700
020 0002	17 x 2.0		600/3000



### 4507

Perimetral band in PE foam with adhesive back and mortar containment PE strip.

**i** Precut H = 100 mm

Code	Type	Price €/m	Unit/Box (m)
450 0443	H 150 x 5 mm		50/250
450 0007	H 150 x 8 mm		25/125



### 1480P

90° plastic elbow to protect and support COBRAPEX pipe near the connection to the distribution manifold.

Code	Type	Price €	Unit/Box
034 0077	Pipe Ø 14 - 18		25/200



### 4540

Additive for screeds in water-based solution including acrylic polymers. It reduces hygroscopic receding and increases thermal resistance, thus improving thermal conductivity.

#### TECHNICAL SPECIFICATIONS

- Dose: 1 kg additive x 100 Kg concrete

Code	Type	Price €/kg	Unit/Box (kg)
450 0019	10 Kg ≈ 9.6 l		10/10
450 0017	25 Kg ≈ 24 l		25/25



### 4508

PE expansion joint, self-adhesive base for smooth and ashlar panels.

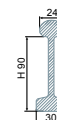

#### TECHNICAL SPECIFICATIONS

- Height: 90 mm
- Length: 2 m

Code	Type	Price €/m	Unit/Box (m)
450 0023	-		20/180

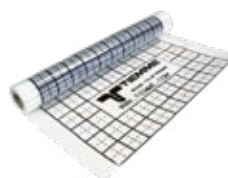

### 4503

PE moisture-proof insulating strip

#### TECHNICAL SPECIFICATIONS

- Width: 1.2 m
- Length: 100 m
- Thickness: 0.15 mm

Code	Type	Price €/m <sup>2</sup>	Unit/Box (m <sup>2</sup> )
450 0025	-		120/120



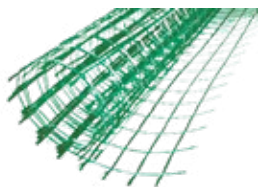

### 4532

Fiberglass mesh with anti-alkaline treatment to reinforce concrete screeds.

#### TECHNICAL SPECIFICATIONS

- Mesh size: 40 x 40 mm
- Weight: 130 g/m<sup>2</sup>

**i** 2 mm thread metal mesh upon request.

Code	Type	Price €/m <sup>2</sup>	Unit/Box (m <sup>2</sup> )
450 0152	1 m x 50 m		50/400
450 0022	1 m x 100 m		100/400



### 4539

Protects against the corrosion of metal particles with universal bactericide and fungicide for heating and cooling systems.

#### TECHNICAL SPECIFICATIONS

- Dose: 1 l additive x 100 l circulating water

Code	Type	Price €	Unit/Box
450 0486	1 l		1/12

# 01<sub>D</sub> NEW CLASSIC GRAPHITE

## INTRODUCTION

The ideal solution for residential and commercial cooling and heating systems. Ashlar panels result from the combination of a foam polystyrene base with added graphite formed with advanced technology, and a 0.16 mm thick polystyrene strip. This creates a panel that is easy to use and available with a 10 to 55 mm thick insulating layer, a certified product with high compressive resistance. Panels are bonded by means of a special bonding system with perimetral connections. 50 mm and multiple pipe distance.

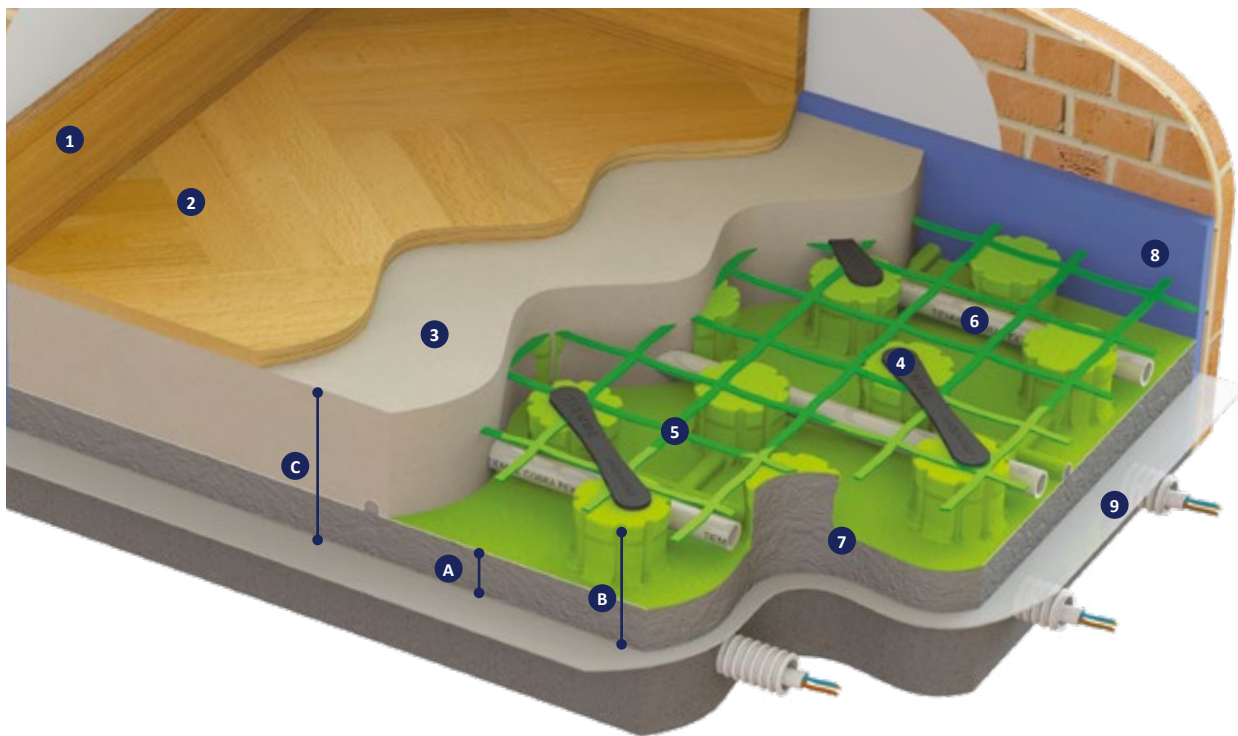

- |                         |              |
|-------------------------|--------------|
| 1. Skirting             | -            |
| 2. Coating              | -            |
| 3. Screed               | -            |
| 4. Gripper rod for mesh | art. 4527    |
| 5. Fiberglass mesh      | art. 4532    |
| 6. Pipe                 | art. 0200B   |
| 7. Insulating panel     | art. 4500GRF |
| 8. Perimetral band      | art. 4507    |
| 9. PE strip             | art. 4503    |

Code	Size (mm)		
	A	B	C
450 0479	10	34	60 ÷ 70
450 0480	17	41	67 ÷ 77
450 0481	32	56	82 ÷ 92
450 0482	40	64	90 ÷ 100
450 0483	55	79	105 ÷ 115

### UNI EN 1264 COMPLIANT THICKNESS\*

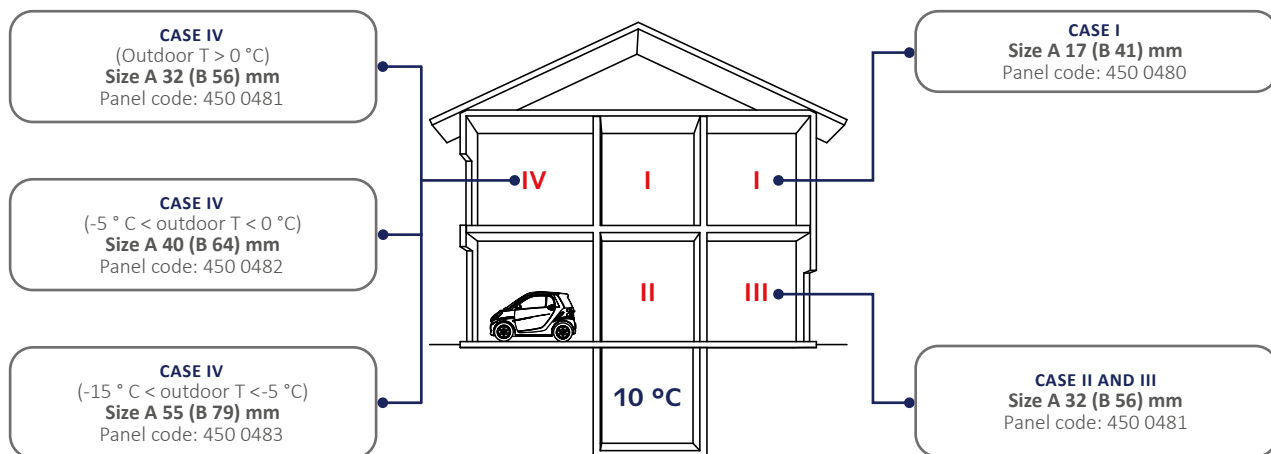

\* To obtain the thermal resistance value required by the UNI EN 1264 standard, it is possible to add an insulating mat.



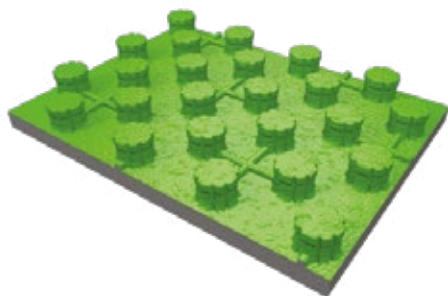

### 4500GRF

Insulating panel made in sintered foam polystyrene with added graphite in compliance with UNI EN 13163 standard. Embossed details (ashlars) to fasten the pipe - 50 mm distance - and grooves to firmly join panels.

Code	Insulating thickness (mm)	CS 10% (kPa)	Price €/m <sup>2</sup>	Unit/Box (m <sup>2</sup> )	Unit/Box (no. panels)
450 0479	10	250		21.12/84.48	22
450 0480	17	150		13.44/67.2	14
450 0481	32	150		9.6/48	10
450 0482	40	150		7.68/38.4	8
450 0483	55	150		7.68/30.72	8

### TECHNICAL SPECIFICATIONS

	Codes				
	450 0479	450 0480	450 0481	450 0482	450 0483
Thermal resistance EN 13163 (m <sup>2</sup> k/W)	0.50	0.75	1.25	1.50	2.00
10% compressive resistance UNI EN 826 (kPa)	250	150	150	150	150
Insulating thickness (mm)	10	17	32	40	55
Total thickness (mm)	34	41	56	64	79
<b>Total equivalent thickness UNI EN 1264/3 (mm)</b>	<b>15.7</b>	<b>22.5</b>	<b>37.5</b>	<b>45</b>	<b>60</b>
Coating film (µm)	160				
Minimum pipe distance [mm]	50				
Heat conductivity UNI EN 12667 (W/mK)	0.030				
Density (kg/m <sup>3</sup> )	40	25	25	25	25
Water absorption UNI EN 12087 (%)	7				
Euroclass reaction to fire EN 13501-1	E				
Panel total size (mm)	1220 x 820				
Usable panel size (mm)	1200 x 800				
Usable panel surface (m <sup>2</sup> )	0.96				
Panels per pack (n)	22	14	10	8	8
Panel surface per pack (m <sup>2</sup> )	21.12	13.44	9.60	7.68	7.68



### 0200B

COBRAPEX cross-linked polyethylene high density pipe with EVOH anti-oxygen barrier.

#### TECHNICAL SPECIFICATIONS

- Max operating temperature: 95 °C
- Thermal conductivity: 0,38 W/mk
- EN ISO 15875-2 compliant
- EVOH, DIN 4726 compliant anti-oxygen barrier
- Composition: PE-Xb

Code	Type	Price €/m	Unit/Box (m)
020 0005	16 x 2.0		120/3240
020 0018	16 x 2.0		200/3600
020 0003	16 x 2.0		300/3600
020 0001	16 x 2.0		600/3000
020 0008	17 x 2.0		120/3240
020 0071	17 x 2.0		200/3200
020 0006	17 x 2.0		300/2700
020 0002	17 x 2.0		600/3000



### 4507

Perimetral band in PE foam with adhesive back and mortar containment PE strip.

 Precut H = 100 mm

Code	Type	Price €/m	Unit/Box (m)
450 0443	H 150 x 5 mm		50/250
450 0007	H 150 x 8 mm		25/125



### 1480P

90° plastic elbow to protect and support COBRAPEX pipe near the connection to the distribution manifold.

Code	Type	Price €	Unit/Box
034 0077	Pipe Ø 14 - 18		25/200



### 4527

Gripper rod to fasten the mesh. Made in plastic and including fastening tabs.

Code	Type	Price €	Unit/Box
450 0018	H = 28 mm		100/1000



### 4540

Additive for screeds in water-based solution including acrylic polymers. It reduces hygroscopic receding and increases thermal resistance, thus improving thermal conductivity.

#### TECHNICAL SPECIFICATIONS

- Dose: 1 kg additive x 100 Kg concrete

Code	Type	Price €/kg	Unit/Box (kg)
450 0019	10 Kg ≈ 9.6 l		10/10
450 0017	25 Kg ≈ 24 l		25/25



### 4508

PE expansion joint, self-adhesive base for smooth and ashlar panels.

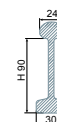

#### TECHNICAL SPECIFICATIONS

- Height: 90 mm
- Length: 2 m

Code	Type	Price €/m	Unit/Box (m)
450 0023	-		20/180

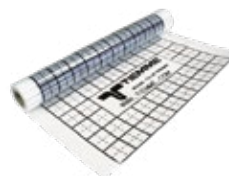

### 4503

PE moisture-proof insulating strip

#### TECHNICAL SPECIFICATIONS

- Width: 1.2 m
- Length: 100 m
- Thickness: 0.15 mm

Code	Type	Price €/m <sup>2</sup>	Unit/Box (m <sup>2</sup> )
450 0025	-		120/120



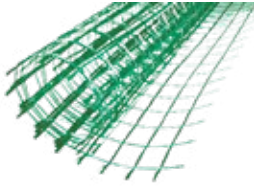

### 4532

Fiberglass mesh with anti-alkaline treatment to reinforce concrete screeds.

#### TECHNICAL SPECIFICATIONS

- Mesh size: 40 x 40 mm
- Weight: 130 g/m<sup>2</sup>

**i** 2 mm thread metal mesh upon request.

Code	Type	Price €/m <sup>2</sup>	Unit/Box (m <sup>2</sup> )
450 0152	1 m x 50 m		50/400
450 0022	1 m x 100 m		100/400



### 4539

Protects against the corrosion of metal particles with universal bactericide and fungicide for heating and cooling systems.

#### TECHNICAL SPECIFICATIONS

- Dose: 1 l additive x 100 l circulating water

Code	Type	Price €	Unit/Box
450 0486	1 l		1/12

The ideal solution for residential and commercial cooling and heating systems. The thermoformed panel with ashlars allows to reduce thickness and it is therefore suitable for renovating interventions. Maximum protection against thermal bridges. 50 mm and multiple pipe distance. Panels are bonded by overlapping side ashlars.

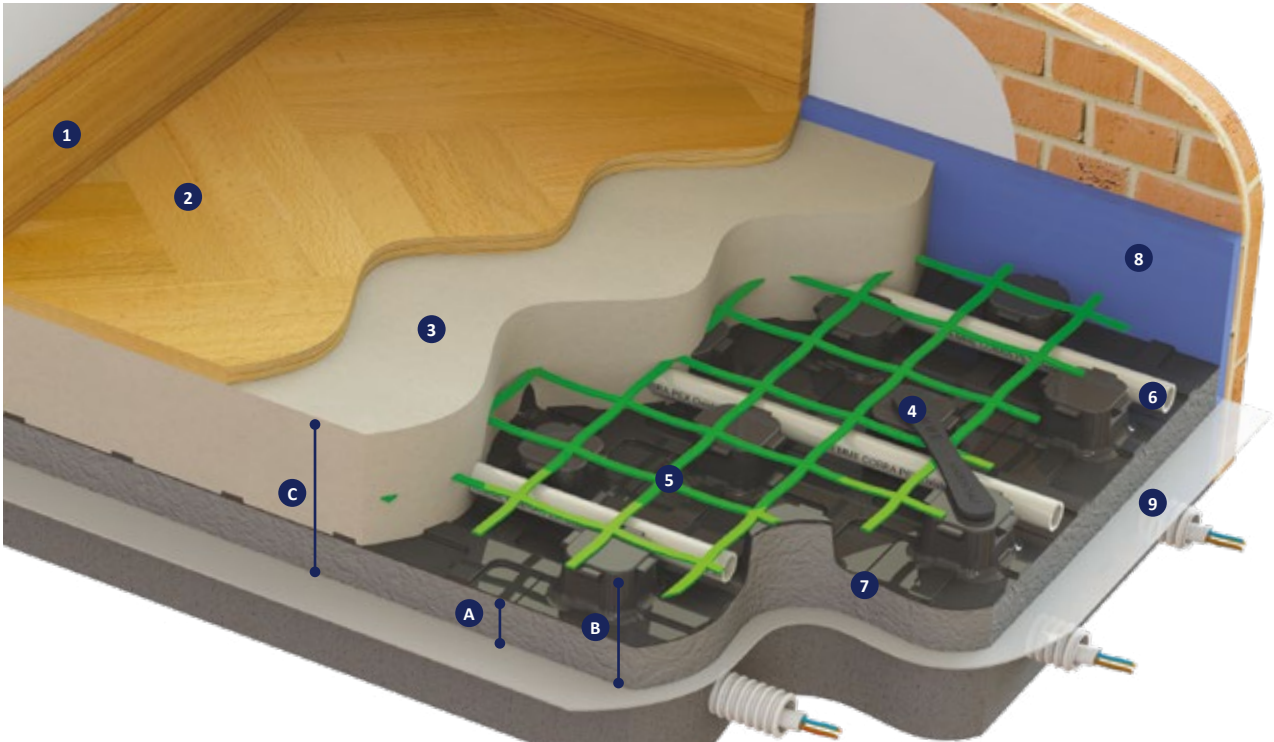

- |                         |                 |
|-------------------------|-----------------|
| 1. Skirting             | -               |
| 2. Coating              | -               |
| 3. Screed               | -               |
| 4. Gripper rod for mesh | art. 4527       |
| 5. Fiberglass mesh      | art. 4532       |
| 6. Pipe                 | art. 0200B      |
| 7. Insulating panel     | art. 4500PANGRF |
| 8. Perimetral band      | art. 4507       |
| 9. PE strip             | art. 4503       |

Code	Size (mm)		
	A	B	C
450 0487	10	32	60 ÷ 70
450 0488	19	41	69 ÷ 79
450 0489	34	56	84 ÷ 94
450 0490	42	64	92 ÷ 102
450 0491	57	79	107 ÷ 117

### UNI EN 1264 COMPLIANT THICKNESS\*

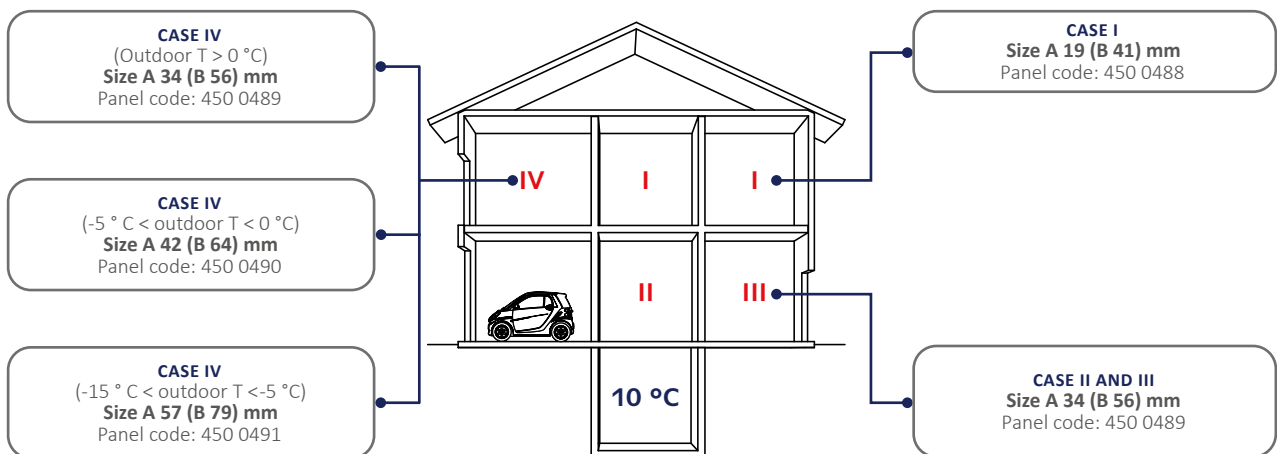

\* To obtain the thermal resistance value required by the UNI EN 1264 standard, it is possible to add an insulating mat.







### 4502PANGRF

Thermoformed panel with ashlar made in foam polystyrene, sintered with graphite and bonded to a hard black polystyrene black foil with ashlar. In compliance with EN 13163 standard, it has embossed details to fasten the pipe (50 mm distance) and male-female connections for a firm joint. The rigid strip lends the panel higher resistance to wear and impact. Perimetral male-female connections allow to overlap strips and make it suitable for liquid self leveling screeds.

Code	Insulating thickness (mm)	CS 10% (kPa)	Price €/m <sup>2</sup>	Unit/Box (m <sup>2</sup> )	Unit/Box (no. panels)
450 0487	10	200		20.16/100.8	18
450 0488	19	150		13.44/67.2	12
450 0489	34	150		10.08/50.4	9
450 0490	42	150		8.96/44.8	8
450 0491	57	150		6.72/33.6	6

### TECHNICAL SPECIFICATIONS

	Codes				
	450 0487	450 0488	450 0489	450 0490	450 0491
Thermal resistance EN 13163 (m <sup>2</sup> k/W)	0.48	0.75	1.25	1.50	2.00
10% compressive resistance UNI EN 826 (kPa)	200	150	150	150	150
Insulating thickness (mm)	10	19	34	42	57
Total thickness (mm)	32	41	56	64	79
<b>Total equivalent thickness UNI EN 1264/3 (mm)</b>	<b>15</b>	<b>24</b>	<b>39</b>	<b>47</b>	<b>62</b>
Rigid covering foil (mm)	0.6				
Minimum pipe distance [mm]	50				
Heat conductivity UNI EN 12667 (W/mK)	0.031				
Density (kg/m <sup>3</sup> )	30	25	25	25	25
Water absorption UNI EN 12087 (%)	6.5	4.0	4.0	4.0	4.0
Euroclass reaction to fire EN 13501-1	E				
Panel total size (mm)	1450 X 850				
Usable panel size (mm)	1400 X 800				
Usable panel surface (m <sup>2</sup> )	1.12				
Panels per pack (n)	18	12	9	8	6
Panel surface per pack (m <sup>2</sup> )	20.16	13.44	10.08	8.96	6.72



### 0200B

COBRAPEX cross-linked polyethylene high density pipe with EVOH anti-oxygen barrier.

#### TECHNICAL SPECIFICATIONS

- Max operating temperature: 95 °C
- Thermal conductivity: 0,38 W/mk
- EN ISO 15875-2 compliant
- EVOH, DIN 4726 compliant anti-oxygen barrier
- Composition: PE-Xb

Code	Type	Price €/m	Unit/Box (m)
020 0005	16 x 2.0		120/3240
020 0018	16 x 2.0		200/3600
020 0003	16 x 2.0		300/3600
020 0001	16 x 2.0		600/3000
020 0008	17 x 2.0		120/3240
020 0071	17 x 2.0		200/3200
020 0006	17 x 2.0		300/2700
020 0002	17 x 2.0		600/3000



### 4507

Perimetral band in PE foam with adhesive back and mortar containment PE strip.

**i** Precut H = 100 mm

Code	Type	Price €/m	Unit/Box (m)
450 0443	H 150 x 5 mm		50/250
450 0007	H 150 x 8 mm		25/125



### 1480P

90° plastic elbow to protect and support COBRAPEX pipe near the connection to the distribution manifold.

Code	Type	Price €	Unit/Box
034 0077	Pipe Ø 14 - 18		25/200



### 4527

Gripper rod to fasten the mesh. Made in plastic and including fastening tabs.

Code	Type (mm)	Price €	Unit/Box
450 0018	H = 28		100/1000



### 4540

Additive for screeds in water-based solution including acrylic polymers. It reduces hygroscopic receding and increases thermal resistance, thus improving thermal conductivity.

#### TECHNICAL SPECIFICATIONS

- Dose: 1 kg additive x 100 Kg concrete

Code	Type	Price €/kg	Unit/Box (kg)
450 0019	10 Kg ≈ 9,6 l		10/10
450 0017	25 Kg ≈ 24 l		25/25



### 4508

PE expansion joint, self-adhesive base for smooth and ashlar panels.

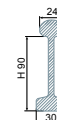

#### TECHNICAL SPECIFICATIONS

- Height: 90 mm
- Length: 2 m

Code	Type	Price €/m	Unit/Box (m)
450 0023	-		20/180

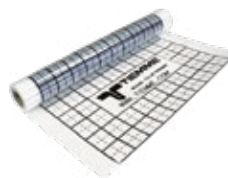

### 4503

PE moisture-proof insulating strip

#### TECHNICAL SPECIFICATIONS

- Width: 1.2 m
- Length: 100 m
- Thickness: 0.15 mm

Code	Type	Price €/m²	Unit/Box (m²)
450 0025	-		120/120



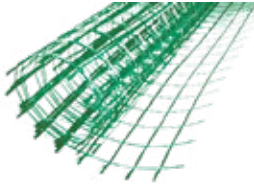

### 4532

Fiberglass mesh with anti-alkaline treatment to reinforce concrete screeds.

#### TECHNICAL SPECIFICATIONS

- Mesh size: 40 x 40 mm
- Weight: 130 g/m<sup>2</sup>

 2 mm thread metal mesh upon request.

Code	Type	Price €/m <sup>2</sup>	Unit/Box (m <sup>2</sup> )
450 0152	1 m x 50 m		50/400
450 0022	1 m x 100 m		100/400



### 4539

Protects against the corrosion of metal particles with universal bactericide and fungicide for heating and cooling systems.

#### TECHNICAL SPECIFICATIONS

- Dose: 1 l additive x 100 l circulating water

Code	Type	Price €	Unit/Box
450 0486	1 l		1/12

A solution designed for residential and commercial cooling and heating systems requiring maximum thermal performance. The smooth panel's silk-screened heat-reflecting surface enables free laying spacing installation. Panels are bonded by overlapping the heat-reflecting surface side with a double-sided adhesive strip. Maximum protection against thermal bridges.

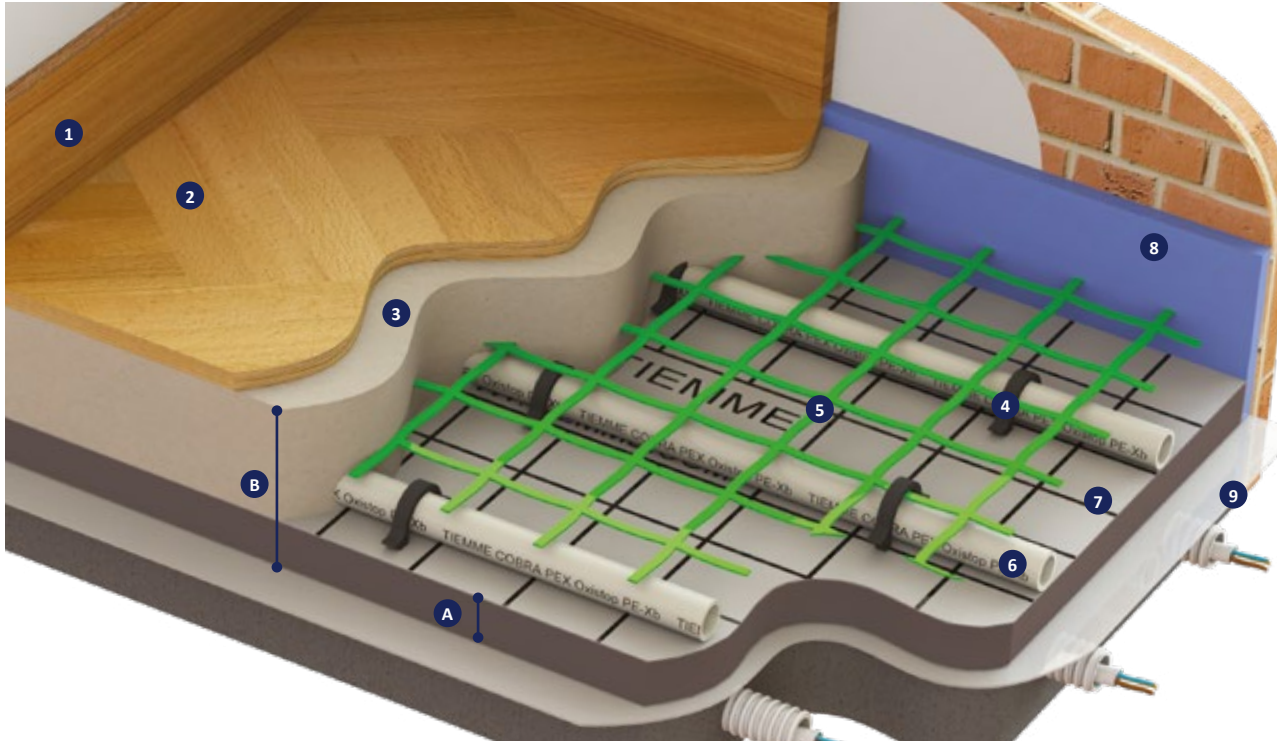

- |                              |                   |
|------------------------------|-------------------|
| 1. Skirting                  | -                 |
| 2. Coating                   | -                 |
| 3. Screed                    | -                 |
| 4. Gripper rod for pipe-mesh | art. 4521 - 4520G |
| 5. Fiberglass mesh           | art. 4532         |
| 6. Pipe                      | art. 0200B        |
| 7. Insulating panel          | art. 4505GRF      |
| 8. Perimetral band           | art. 4507         |
| 9. PE strip                  | art. 4503         |

Code	Size (mm)	
	A	B
450 0558	23	73 ÷ 83
450 0559	30	80 ÷ 90
450 0560	40	90 ÷ 100
450 0555	50	100 ÷ 110
450 0561	60	110 ÷ 120

### UNI EN 1264 COMPLIANT THICKNESS\*

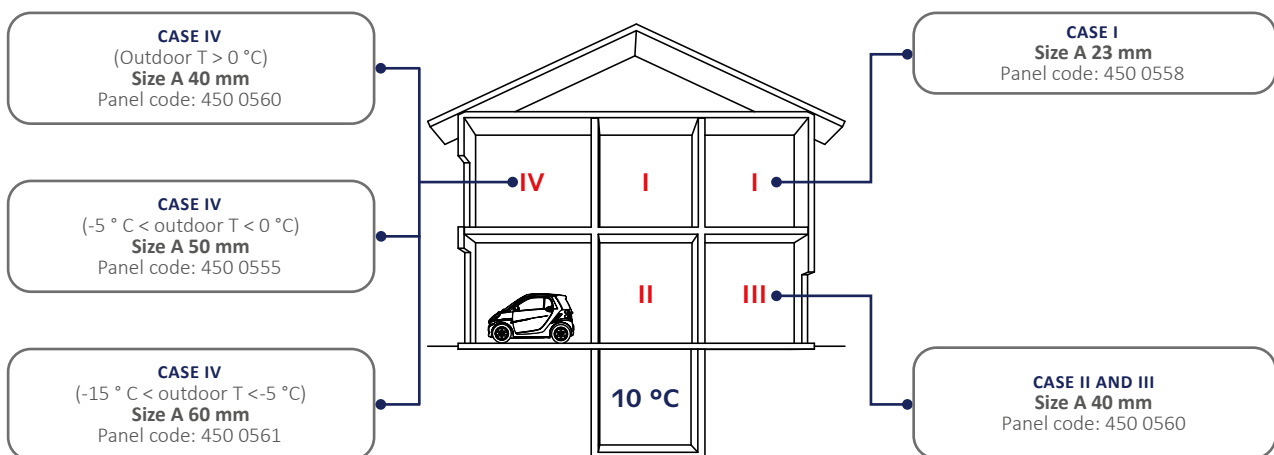

\* To obtain the thermal resistance value required by the UNI EN 1264 standard, it is possible to add an insulating mat.





### 4505GRF

Smooth foam polystyrene thermal insulating panel EPS sintered with graphite, with protective film and 50 mm distance and multiple silk-screening .

Code	Thickness (mm)	CS 10% (kPa)	Price €/m <sup>2</sup>	Unit/Box (m <sup>2</sup> )
450 0558	23	150		12/72
450 0559	30	150		10/60
450 0560	40	150		10/40
450 0555	50	150		10/40
450 0561	60	150		8/32

### TECHNICAL SPECIFICATIONS

	Codes				
	450 0558	450 0559	450 0560	450 0555	450 0561
Thermal resistance UNI EN 13163 (m <sup>2</sup> k/W)	0.76	1.00	1.33	1.66	2.00
10% compressive resistance UNI EN 826 (kPa)	150				
Insulating thickness (mm)	23	30	40	50	60
Total thickness (mm)	23	30	40	50	60
<b>Total equivalent thickness UNI EN 1264/3 (mm)</b>	<b>23</b>	<b>30</b>	<b>40</b>	<b>50</b>	<b>60</b>
Minimum pipe distance [mm]	50				
Heat conductivity UNI EN 12667 (W/mK)	0.030				
Water absorption UNI EN 12087 (%)	< 3.0				
Euroclass reaction to fire EN 13501-1	E				
Roll total size (mm)	12000 x 1000	10000 x 1000	10000 x 1000	10000 x 1000	8000 x 1000
Usable roll size (mm)	12000 x 1000	10000 x 1000	10000 x 1000	10000 x 1000	8000 x 1000
Usable roll surface (m <sup>2</sup> )	12	10	10	10	8
Rolls per pack (n)	1				
Roll surface per pack (m <sup>2</sup> )	12	10	10	10	8



### 0200B

COBRAPEX cross-linked polyethylene high density pipe with EVOH anti-oxygen barrier.

#### TECHNICAL SPECIFICATIONS

- Max operating temperature: 95 °C
- Thermal conductivity: 0,38 W/mk
- EN ISO 15875-2 compliant
- EVOH, DIN 4726 compliant anti-oxygen barrier
- Composition: PE-Xb

Code	Type	Price €/m	Unit/Box (m)
020 0005	16 x 2.0		120/3240
020 0018	16 x 2.0		200/3600
020 0003	16 x 2.0		300/3600
020 0001	16 x 2.0		600/3000
020 0008	17 x 2.0		120/3240
020 0071	17 x 2.0		200/3200
020 0006	17 x 2.0		300/2700
020 0002	17 x 2.0		600/3000



### 4507

Perimetral band in PE foam with adhesive back and mortar containment PE strip.

 Precut H = 100 mm

Code	Type	Price €/m	Unit/Box (m)
450 0443	H 150 x 5 mm		50/250
450 0007	H 150 x 8 mm		25/125



### 1480P

90° plastic elbow to protect and support COBRAPEX pipe near the connection to the distribution manifold.

Code	Type	Price €	Unit/Box
034 0077	Pipe Ø 14 - 18		25/200



### 4521

Gripper rod to fasten the pipe, with manual insertion. Made in plastic and including fastening tabs.

Code	Type	Price €	Unit/Box
450 0035	H = 45 mm		200/1000
450 0037	H = 50 mm		200/1000

Suitable up to pipe Ø20



### 4520G

Gripper rod to fasten the pipe, with automatic insertion. Made in plastic and including fastening tabs. Provided in 30 strips to be used with the automatic rod fastener.

Code	Type	Price €	Unit/Box
450 0014	H = 39 mm		1050/1050
450 0536	H = 56 mm		690/690

Suitable up to pipe Ø17

Suitable up to pipe Ø20



### 4540

Additive for screeds in water-based solution including acrylic polymers. It reduces hygroscopic receding and increases thermal resistance, thus improving thermal conductivity.

#### TECHNICAL SPECIFICATIONS

- Dose: 1 kg additive x 100 Kg concrete

Code	Type	Price €/kg	Unit/Box (kg)
450 0019	10 Kg ≈ 9,6 l		10/10
450 0017	25 Kg ≈ 24 l		25/25



### 4508

PE expansion joint, self-adhesive base for smooth and ashlar panels.

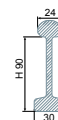

#### TECHNICAL SPECIFICATIONS

- Height: 90 mm
- Length: 2 m

Code	Type	Price €/m	Unit/Box (m)
450 0023	-		20/180



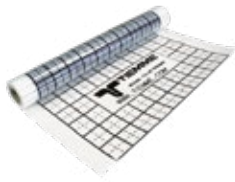

### 4503

PE moisture-proof insulating strip

#### TECHNICAL SPECIFICATIONS

- Width: 1.2 m
- Length: 100 m
- Thickness: 0.15 mm

Code	Type	Price €/m <sup>2</sup>	Unit/Box (m <sup>2</sup> )
450 0025	-		120/120

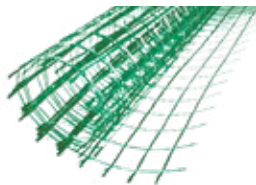

### 4532

Fiberglass mesh with anti-alkaline treatment to reinforce concrete screeds.

#### TECHNICAL SPECIFICATIONS

- Mesh size: 40 x 40 mm
- Weight: 130 g/m<sup>2</sup>

**i** 2 mm thread metal mesh upon request.

Code	Type	Price €/m <sup>2</sup>	Unit/Box (m <sup>2</sup> )
450 0152	1 m x 50 m		50/400
450 0022	1 m x 100 m		100/400



### 4539

Protects against the corrosion of metal particles with universal bactericide and fungicide for heating and cooling systems.

#### TECHNICAL SPECIFICATIONS

- Dose: 1 l additive x 100 l circulating water

Code	Type	Price €	Unit/Box
450 0486	1 l		1/12



### 4520F

Gripper rod fastener.

Code	Type	Price €	Unit/Box
450 0034	-		1/1

A solution designed for residential and commercial cooling and heating systems requiring maximum thermal performance. The silk-screened heat-reflecting surface of the folded smooth panel enables free laying spacing installation. Panels are bonded by overlapping the heat-reflecting surface side with a double-sided adhesive strip. Maximum protection against thermal bridges.

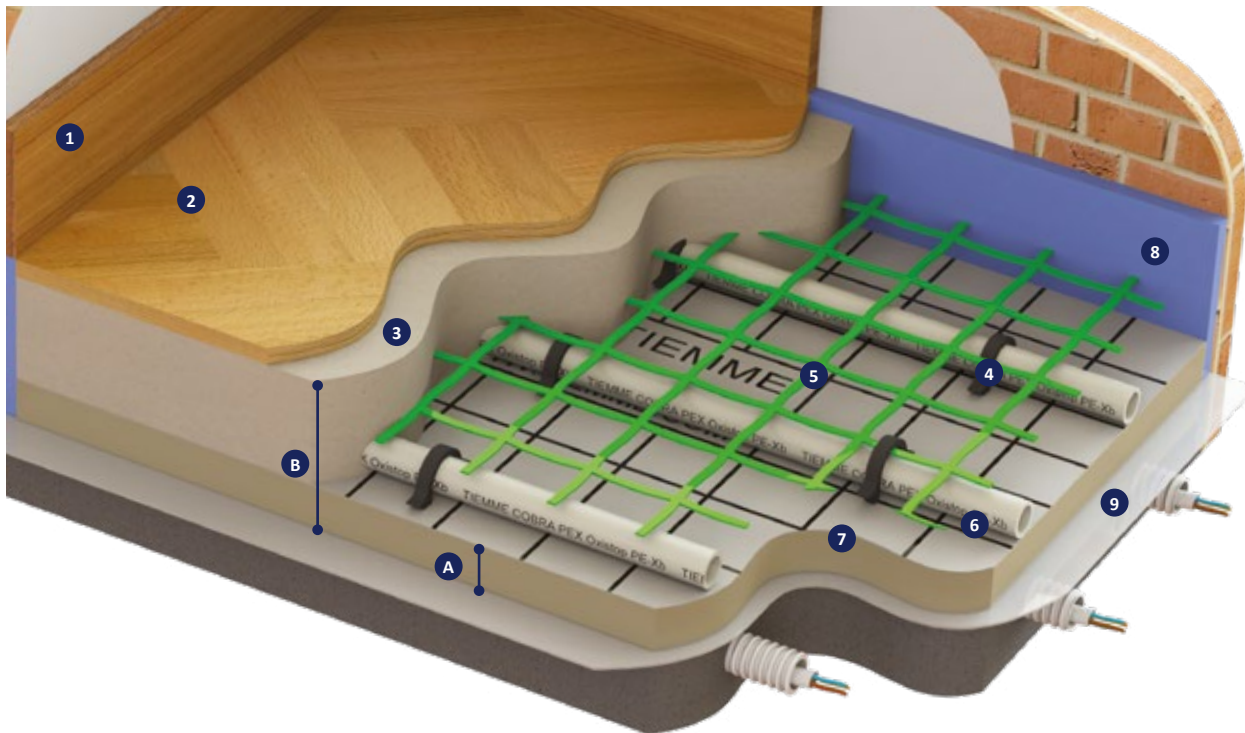

- |                              |                   |
|------------------------------|-------------------|
| 1. Skirting                  | -                 |
| 2. Coating                   | -                 |
| 3. Screed                    | -                 |
| 4. Gripper rod for pipe-mesh | art. 4521 - 4520G |
| 5. Fiberglass mesh           | art. 4532         |
| 6. Pipe                      | art. 0200B        |
| 7. Insulating panel          | art. 4505POL      |
| 8. Perimetral band           | art. 4507         |
| 9. PE strip                  | art. 4503         |

Code	Size (mm)	
	A	B
450 0500	20	70 ÷ 80
450 0501	30	80 ÷ 90
450 0502	40	90 ÷ 100
450 0503	50	100 ÷ 110

### UNI EN 1264 COMPLIANT THICKNESS\*

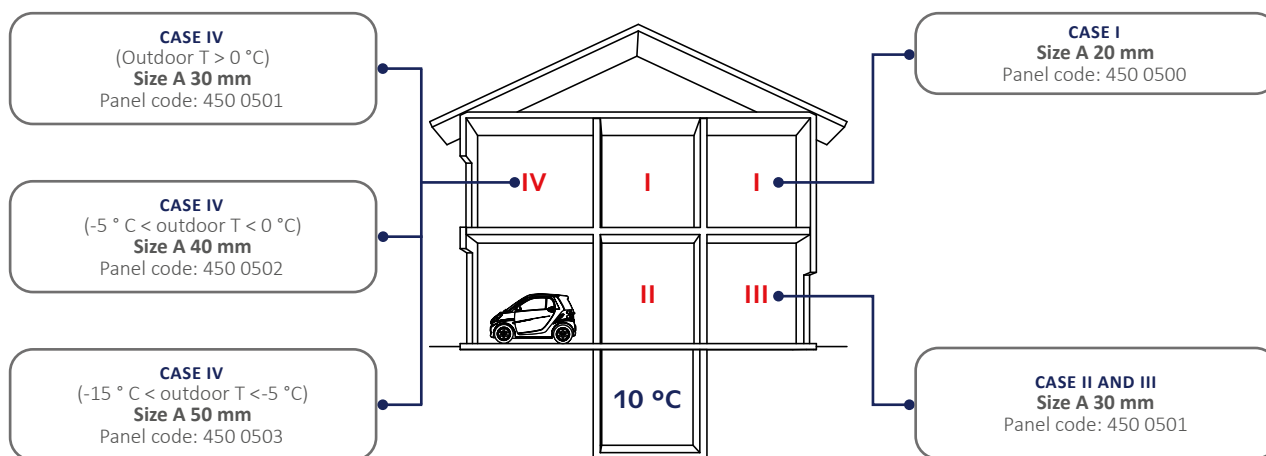

\* To obtain the thermal resistance value required by the UNI EN 1264 standard, it is possible to add an insulating mat.







### 4505POL

Smooth foam polyiso PIR (combined with polyurethane) thermal insulating panel, smooth with graphite, with protective film and 50 mm distance and multiple silk-screening . Folded.

Code	Thickness (mm)	CS 10% (kPa)	Price €/m <sup>2</sup>	Unit/Box (m <sup>2</sup> )	Unit/Box (no. panels)
450 0500	20	>130		16.8/134.4	7
450 0501	30	>130		12/84	5
450 0502	40	>130		9.6/57.6	4
450 0503	50	>130		9.6/48	4

### TECHNICAL SPECIFICATIONS

	Codes			
	450 0500	450 0501	450 0502	450 0503
Thermal resistance UNI EN 13163 (m <sup>2</sup> k/W)	0.85	1.30	1.70	2.15
10% compressive resistance UNI EN 826 (kPa)	>130			
Insulating thickness (mm)	20	30	40	50
Total thickness (mm)	20	30	40	50
<b>Total equivalent thickness UNI EN 1264/3 (mm)</b>	<b>20</b>	<b>30</b>	<b>40</b>	<b>50</b>
Minimum pipe distance [mm]	50			
Heat conductivity UNI EN 12667 (W/mK)	0.023			
Density (kg/m <sup>3</sup> )	30			
Water absorption UNI EN 12087 (%)	< 1.0			
Euroclass reaction to fire EN 13501-1	F			
Panel total size (mm)	1000 x (1200 + 1200)			
Usable panel size (open) (mm)	1000 x 2400			
Usable panel surface (open) (m <sup>2</sup> )	2.4			
Panels per pack (n)	7	5	4	4
Roll surface per pack (m <sup>2</sup> )	16.8	12	9.6	9.6



### 0200B

COBRAPEX cross-linked polyethylene high density pipe with EVOH anti-oxygen barrier.

#### TECHNICAL SPECIFICATIONS

- Max operating temperature: 95 °C
- Thermal conductivity: 0,38 W/mk
- EN ISO 15875-2 compliant
- EVOH, DIN 4726 compliant anti-oxygen barrier
- Composition: PE-Xb

Code	Type	Price €/m	Unit/Box (m)
020 0005	16 x 2.0		120/3240
020 0018	16 x 2.0		200/3600
020 0003	16 x 2.0		300/3600
020 0001	16 x 2.0		600/3000
020 0008	17 x 2.0		120/3240
020 0071	17 x 2.0		200/3200
020 0006	17 x 2.0		300/2700
020 0002	17 x 2.0		600/3000



### 4507

Perimetral band in PE foam with adhesive back and mortar containment PE strip.

 Precut H = 100 mm

Code	Type	Price €/m	Unit/Box (m)
450 0443	H 150 x 5 mm		50/250
450 0007	H 150 x 8 mm		25/125



### 1480P

90° plastic elbow to protect and support COBRAPEX pipe near the connection to the distribution manifold.

Code	Type	Price €	Unit/Box
034 0077	Pipe Ø 14 - 18		25/200



### 4521

Gripper rod to fasten the pipe, with manual insertion. Made in plastic and including fastening tabs.

Code	Type	Price €	Unit/Box
450 0035	H = 45 mm		200/1000
450 0037	H = 50 mm		200/1000

Suitable up to pipe Ø20



### 4520G

Gripper rod to fasten the pipe, with automatic insertion. Made in plastic and including fastening tabs. Provided in 30 strips to be used with the automatic rod fastener.

Code	Type	Price €	Unit/Box
450 0014	H = 39 mm		1050/1050
450 0536	H = 56 mm		690/690

Suitable up to pipe Ø17

Suitable up to pipe Ø20



### 4540

Additive for screeds in water-based solution including acrylic polymers. It reduces hygroscopic receding and increases thermal resistance, thus improving thermal conductivity.

#### TECHNICAL SPECIFICATIONS

- Dose: 1 kg additive x 100 Kg concrete

Code	Type	Price €/kg	Unit/Box (kg)
450 0019	10 Kg ≈ 9,6 l		10/10
450 0017	25 Kg ≈ 24 l		25/25



### 4508

PE expansion joint, self-adhesive base for smooth and ashlar panels.

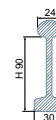

#### TECHNICAL SPECIFICATIONS

- Height: 90 mm
- Length: 2 m

Code	Type	Price €/m	Unit/Box (m)
450 0023	-		20/180



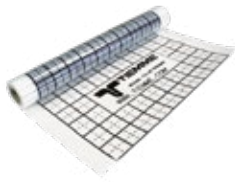

### 4503

PE moisture-proof insulating strip

#### TECHNICAL SPECIFICATIONS

- Width: 1.2 m
- Length: 100 m
- Thickness: 0.15 mm

Code	Type	Price €/m <sup>2</sup>	Unit/Box (m <sup>2</sup> )
450 0025	-		120/120

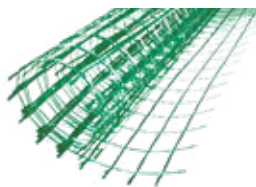

### 4532

Fiberglass mesh with anti-alkaline treatment to reinforce concrete screeds.

#### TECHNICAL SPECIFICATIONS

- Mesh size: 40 x 40 mm
- Weight: 130 g/m<sup>2</sup>

**i** 2 mm thread metal mesh upon request.

Code	Type	Price €/m <sup>2</sup>	Unit/Box (m <sup>2</sup> )
450 0152	1 m x 50 m		50/400
450 0022	1 m x 100 m		100/400



### 4539

Protects against the corrosion of metal particles with universal bactericide and fungicide for heating and cooling systems.

#### TECHNICAL SPECIFICATIONS

- Dose: 1 l additive x 100 l circulating water

Code	Type	Price €	Unit/Box
450 0486	1 l		1/12



### 4520F

Gripper rod fastener.

Code	Type	Price €	Unit/Box
450 0034	-		1/1

An environmental friendly solution in natural blond chemical-free Italian cork. Including a perimetral band in the same material.

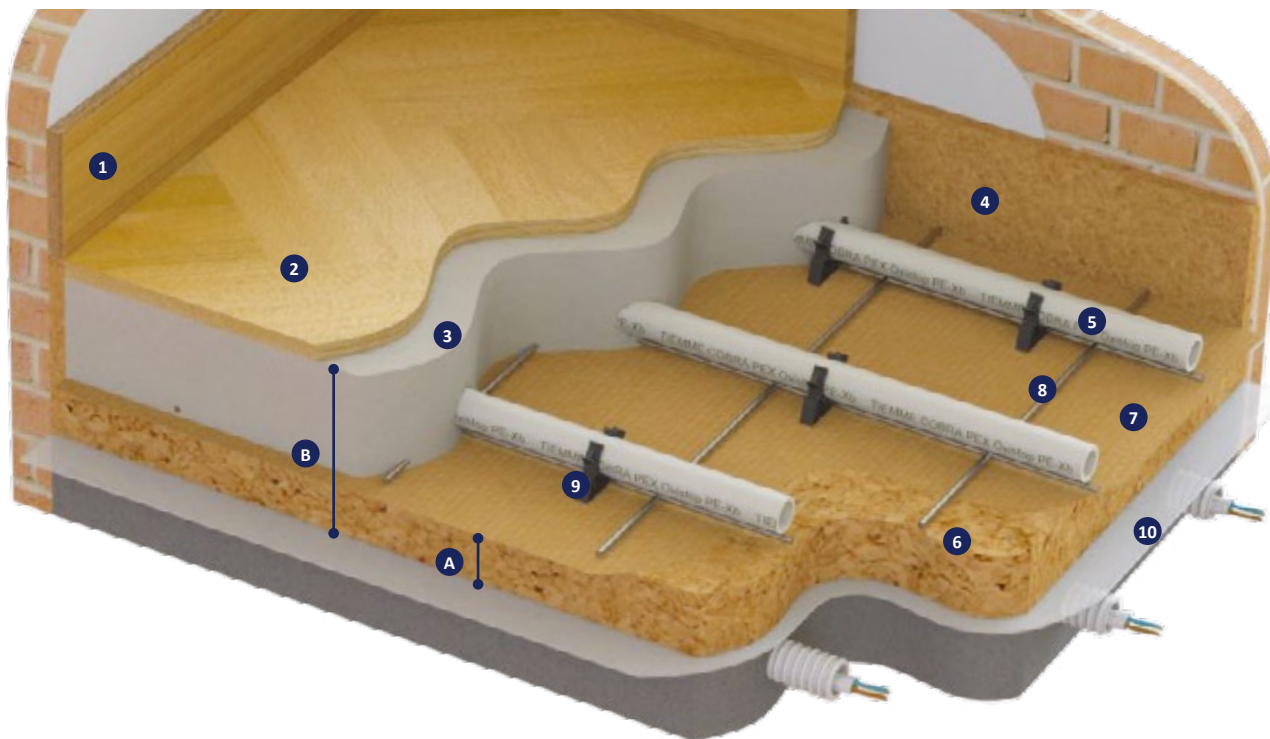

- |                         |            |
|-------------------------|------------|
| 1. Skirting             | -          |
| 2. Coating              | -          |
| 3. Screed               | -          |
| 4. Perimetral band      | art. 5576S |
| 5. Pipe                 | art. 0200B |
| 6. Insulating panel     | art. 5575P |
| 7. Separating layer     | art. 5577S |
| 8. Metal mesh           | art. 4531  |
| 9. Gripper rod for mesh | art. 4520C |
| 10. PE strip            | art. 4503  |

Code	Size (mm)	
	A	B
450 0384	20	70 ÷ 80
450 0385	30	80 ÷ 90

### UNI EN 1264 COMPLIANT THICKNESS\*

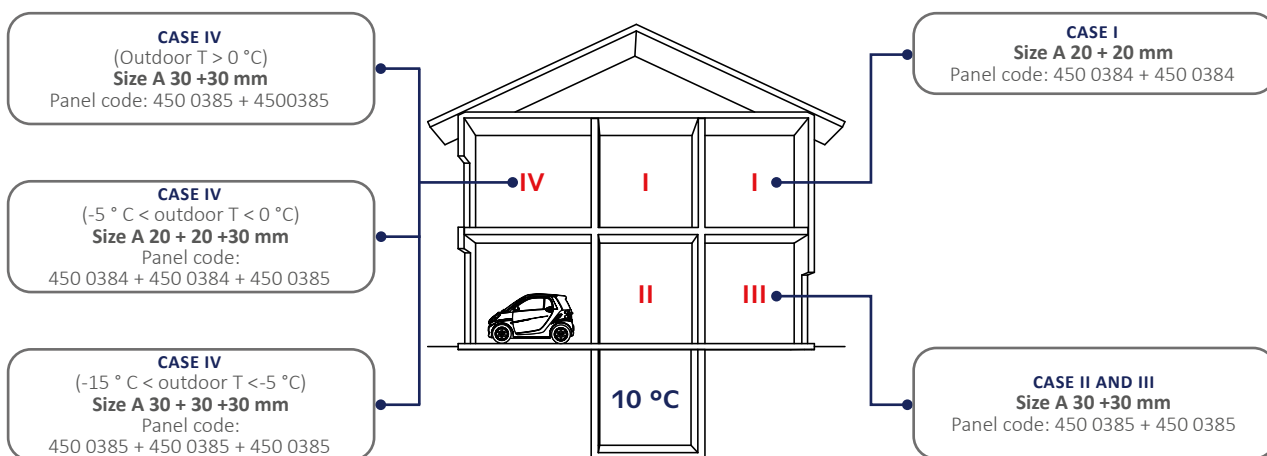

\* To obtain the thermal resistance value required by the UNI EN 1264 standard, it is possible to add an insulating mat.





### 5575P

Thermal insulating panel in natural blond Italian cork, 4/8 mm middle grain.

Code	Thickness (mm)	Price €/m <sup>2</sup>	Unit/Box (m <sup>2</sup> )	Unit/Box (no. panels)
450 0384	20		7.5/7.5	15
450 0385	30		5/5	10

### TECHNICAL SPECIFICATIONS

	Codes	
	450 0384	450 0385
Thermal resistance (m <sup>2</sup> K/W)	0.45	0.68
Compressive resistance (1 mm deflection) (kg/cm <sup>2</sup> )	1.64	1.64
Insulating thickness (mm)	20	30
<b>Total thickness (mm)</b>	<b>20</b>	<b>30</b>
Minimum pipe distance [mm]	50	
Heat conductivity UNI EN 12667 (W/mK)	0.044	
Density (kg/m <sup>3</sup> )	150/160	
Water absorption UNI EN 12087	0.90	1.25
Euroclass reaction to fire EN 13501-1	E	
Resistance factor to water vapor spreading (μ)	10	
Panel total size (mm)	1000 x 500	
Usable panel size (mm)	1000 x 500	
Usable panel surface (m <sup>2</sup> )	0.5	
Panels per pack (n)	15	10
Panel surface per pack (m <sup>2</sup> )	7.5	5



### 0200B

COBRAPEX cross-linked polyethylene high density pipe with EVOH anti-oxygen barrier.

#### TECHNICAL SPECIFICATIONS

- Max operating temperature: 95 °C
- Thermal conductivity: 0,38 W/mk
- EN ISO 15875-2 compliant
- EVOH, DIN 4726 compliant anti-oxygen barrier
- Composition: PE-Xb

Code	Type	Price €/m	Unit/Box (m)
020 0005	16 x 2.0		120/3240
020 0018	16 x 2.0		200/3600
020 0003	16 x 2.0		300/3600
020 0001	16 x 2.0		600/3000
020 0008	17 x 2.0		120/3240
020 0071	17 x 2.0		200/3200
020 0006	17 x 2.0		300/2700
020 0002	17 x 2.0		600/3000



### 5576S

Perimetral band in natural cork, 100 mm high, 5 mm thick

#### TECHNICAL SPECIFICATIONS

- Density: 290/300 kg/m<sup>3</sup>

Code	Type	Price €/m	Unit/Box (m)
450 0386	H 100 x 5 mm		25/25



### 1480P

90° plastic elbow to protect and support COBRAPEX pipe near the connection to the distribution manifold.

Code	Type	Price €	Unit/Box
034 0077	Pipe Ø 14 - 18		25/200



### 4520C

Gripper rod to fasten the pipe on 3 mm welded mesh with manual insertion, made in plastic material

Code	Type	Price €	Unit/Box
450 0116	Pipe Ø 16 - 17		50/1700



### 4540

Additive for screeds in water-based solution including acrylic polymers. It reduces hygroscopic receding and increases thermal resistance, thus improving thermal conductivity.

#### TECHNICAL SPECIFICATIONS

- Dose: 1 kg additive x 100 Kg concrete

Code	Type	Price €/kg	Unit/Box (kg)
450 0019	10 Kg ≈ 9,6 l		10/10
450 0017	25 Kg ≈ 24 l		25/25



### 4508

PE expansion joint, self-adhesive base for smooth and ashlar panels.

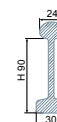

#### TECHNICAL SPECIFICATIONS

- Height: 90 mm
- Length: 2 m

Code	Type	Price €/m	Unit/Box (m)
450 0023	-		20/180



### 4503

PE moisture-proof insulating strip

#### TECHNICAL SPECIFICATIONS

- Width: 1.2 m
- Length: 100 m
- Thickness: 0.15 mm

Code	Type	Price €/m <sup>2</sup>	Unit/Box (m <sup>2</sup> )
450 0025	-		120/120





### 5577S

Separating impact-proof, heat-reflecting layer, waterproof and breathable, for substrates. Provided in 20 m rolls with 1.4 m sheets.

#### TECHNICAL SPECIFICATIONS

- Width: 1.4 m
- Length: 20 m
- Thickness: 6 mm

Code	Type	Price €/m <sup>2</sup>	Unit/Box (m <sup>2</sup> )
450 0387	H 1.4 x 20 m		28/28

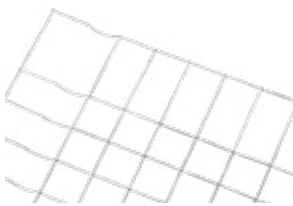

### 4531

Electro-welded hot-dip galvanized mesh with diam. thread 3 mm and 50 x 50 mm mesh. Provided in 1000 x 2000 mm panels

#### TECHNICAL SPECIFICATIONS

- Mesh size: 50 x 50 mm
- Panel size: 1000 x 2000 mm

Code	Type	Price €/m <sup>2</sup>	Unit/Box (m <sup>2</sup> )
450 0124	1000 x 2000 mm		100/100



### 4539

Protects against the corrosion of metal particles with universal bactericide and fungicide for heating and cooling systems.

#### TECHNICAL SPECIFICATIONS

- Dose: 1 l additive x 100 l circulating water

Code	Type	Price €	Unit/Box
450 0486	1 l		1/12

One of the factors connected to the radiant system and to home comfort is acoustic comfort. Acoustic comfort is defined as the condition where a subject is not bothered by extraneous sounds and their auditory system does not suffer any damage resulting from a more or less prolonged exposure to noise. Specifically, there are two main sources of acoustic discomfort in a building: external and internal sources.

**External sources** mainly consist of road traffic and any industrial activity located in close proximity to the building. Noise produced by external sources propagates by air and enters the building through its shell.

Technical and construction characteristics of facades are critical to offer higher or lower resistance to the propagation of external sound waves through the building. That is why openings like windows or air grids are weak points in a building for counteracting noise.

**Internal sources**, which can refer to a specific environment or other environments in the same building, include systems (elevators, service elevators, water systems, etc.), appliances, radio and television devices, voices, shouts and movements of the other residents. In this case propagation occurs both by air and through solid parts of the building.

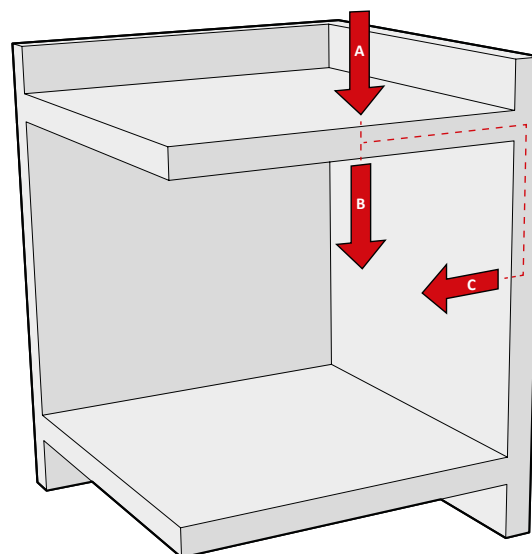

- A. Impact noise
- B. Direct transmission
- C. Lateral transmission

The wide range of Tiemme products includes soundproofing panels with significant values (up to 28 dB), which can help the client meet regulatory requirements.



## TIEMME SOLUTION

### SILENTO

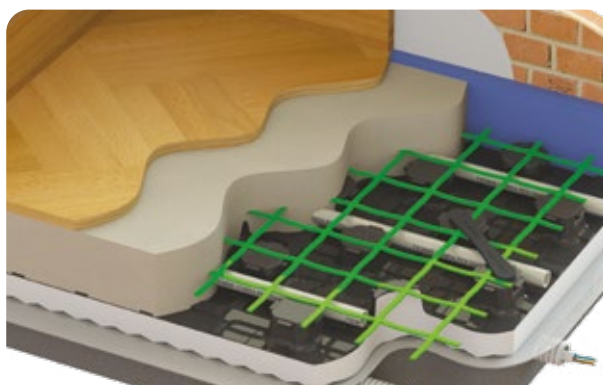



The creation of a radiant system impact the structural aspect of the building and can be classified in the “sources of internal noise” category, specifically in the “impact noise” category. The law (D.P.C.M: 5/12/97) defines different aspects of passive acoustic requirements for a building. Two of those are of particular interest:

- the impact noise within a residential building cannot exceed 63 dB;
- said value needs to be assessed during construction (implying that the “source of noise-soundproofing material-final outcome” system is also affected by the laying process).

However, norms are required for the designing phase, prior to the construction of a building. The European standard EN 12354-2 provides two calculation methods, defined “detailed model” and “simplified model”. It is evident that the results do not take into account possible faults in the materials or in the laying process that cannot be quantified.

As for residential buildings with brick and/or concrete surfaces or floating floors, the simplified model can be applied.

The assessment index for impact noise is as follows:

$$L_{n,w} = L_{n,w,eq} + K - \Delta L_w$$

where:

- $L_{n,w,eq}$ : is the assessment index for the normalized impact noise of a slab without acoustic insulation (bare slab) and its value is calculated on the basis of the slab mass per unit area ( $m^2$ ).
- $K$ : is the corrective factor for the lateral transmission of impact noise depending on the slab mass and the average mass per area of the walls of the affected environment ( $m^2$ ).
- $\Delta L_w$ : is the assessment index of the reduction of impact noise and it is calculated starting from the mass per unit area of the floating floor and the dynamic stiffness of the soundproofing carpet. It is now that the “acoustic insulation” of the radiant panel and its capability to absorb impact noise play a critical role.

## PLOT

The plot below shows the assessment index of the reduction of impact sound pressure level for cement or calcium sulfate mortar floating floors in compliance with UNI EN 12354-2.

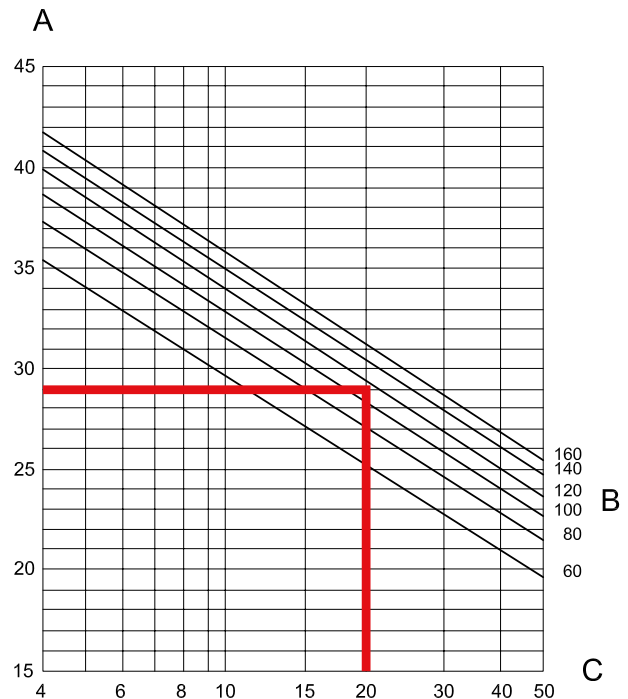

where:

- **A**: Assessment index of the reduction of sound pressure levels  $\Delta L_w$  (dB)
- **B**: Mass per unit area of the floating floor ( $kg/m^2$ )
- **C**: Dynamic stiffness per unit area,  $s'$ , of the resilient layer ( $MN/m^3$ )

Silento is an innovative system including a panel designed to thermally insulate the floor, withhold the pipe, and effectively reduce impact noise.

We could achieve this result by using EPS-T, a high-performance material resulting from an industrial process and enhanced by the specific geometric shape of the panel bottom.

In order to provide EPS-T with further robustness and reliability features, it was coupled with a thermoformed material that can endure high loads both in laying and operating phases.

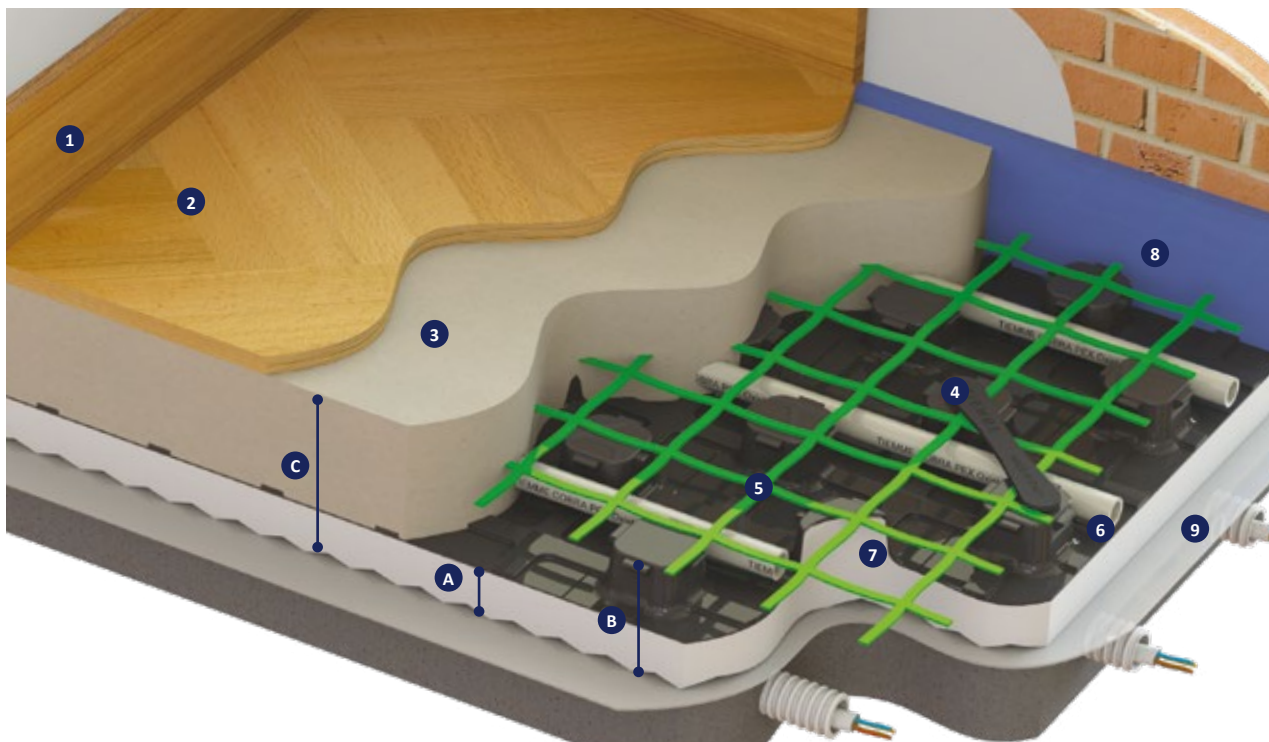

- |                         |              |
|-------------------------|--------------|
| 1. Skirting             | -            |
| 2. Coating              | -            |
| 3. Screed               | -            |
| 4. Gripper rod for mesh | art. 4527    |
| 5. Fiberglass mesh      | art. 4532    |
| 6. Pipe                 | art. 0200B   |
| 7. Insulating panel     | art. 4502SIL |
| 8. Perimetral band      | art. 4513    |
| 9. PE strip             | art. 4503    |

Code	Size (mm)		
	A	B	C
450 0313	30	52	80 ÷ 90

### UNI EN 1264 COMPLIANT THICKNESS\*

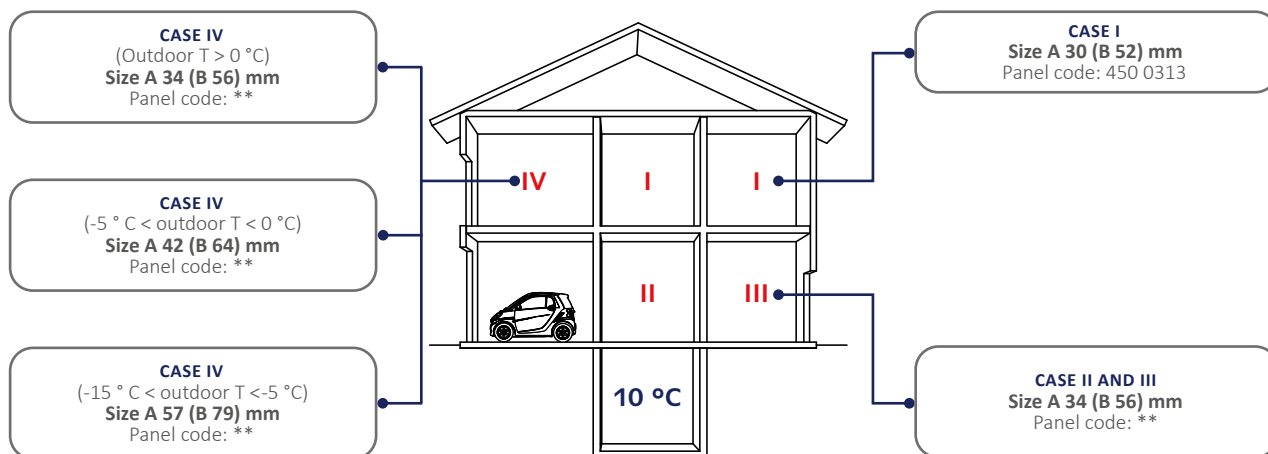

\* To obtain the thermal resistance value required by the UNI EN 1264 standard, it is possible to add an insulating mat.

\*\* Values refer to panel "Techno Graphite" 4502PANGRF with an acoustic impact insulator 4511





### 4502SIL

Insulating thermal impact-proof panel in EPS-T foam polystyrene with embossed ashlars to fasten the pipe. 50 mm and multiplepipe distance.

Code	Insulating thickness (mm)	Price €/m <sup>2</sup>	Unit/Box (m <sup>2</sup> )	Unit/Box (no. panels)
450 0313	30		11.20/56	10

### TECHNICAL SPECIFICATIONS

	Codes
	450 0313
Improvement of acoustic insulation (db)	28
Thermal resistance UNI EN 13163 (m <sup>2</sup> k/W)	0.75
Dynamic stiffness s' (MN/m <sup>3</sup> ) UNI EN 29052-1, mass per unit area of the screed 110 (kg/m <sup>2</sup> )	20
Compressibility level under 2 mm compression UNI EN 12431	CP2
Insulating thickness (mm)	30
Total thickness (mm)	52
Total equivalent thickness UNI EN 1264/3 (mm)	34
Thickness of the covering thermoformed sheath (mm)	0.8
Minimum pipe distance [mm]	50
Heat conductivity UNI EN 12667 (W/mK)	0.040
Euroclass reaction to fire EN 13501-1	E
Panel total size (mm)	1450 x 850
Usable panel size (mm)	1400 x 800
Panel surface (m <sup>2</sup> )	1.12
Panels per pack (n)	10
Panel surface per pack (m <sup>2</sup> )	11.20



### 0200B

COBRAPEX cross-linked polyethylene high density pipe with EVOH anti-oxygen barrier.

#### TECHNICAL SPECIFICATIONS

- Max operating temperature: 95 °C
- Thermal conductivity: 0,38 W/mk
- EN ISO 15875-2 compliant
- EVOH, DIN 4726 compliant anti-oxygen barrier
- Composition: PE-Xb

Code	Type	Price €/m	Unit/Box (m)
020 0005	16 x 2.0		120/3240
020 0018	16 x 2.0		200/3600
020 0003	16 x 2.0		300/3600
020 0001	16 x 2.0		600/3000
020 0008	17 x 2.0		120/3240
020 0071	17 x 2.0		200/3200
020 0006	17 x 2.0		300/2700
020 0002	17 x 2.0		600/3000



### 4511

Underfloor acoustic impact insulator

#### TECHNICAL SPECIFICATIONS

- Width: 1 m
- Length: 5 m
- Thickness: 7 mm

 To be coupled with 4502PANGRF Techno Graphite panel

Code	Type	Price €/m <sup>2</sup>	Unit/Box (m <sup>2</sup> )
450 0317	-		5/120



### 4513

L' preformed perimetral band for acoustic insulation, with adhesive external sides.

Code	Type	Price €/m	Unit/Box (m)
450 0389	H 150 x 6 mm		50/200



### 4507

Perimetral band in PE foam with adhesive back and mortar containment PE strip.

 Precut H = 100 mm

Code	Type	Price €/m	Unit/Box (m)
450 0443	H 150 x 5 mm		50/250
450 0007	H 150 x 8 mm		25/125



### 1480P

90° plastic elbow to protect and support COBRAPEX pipe near the connection to the distribution manifold.

Code	Type	Price €	Unit/Box
034 0077	Pipe Ø 14 - 18		25/200



### 4527

Gripper rod to fasten the mesh. Made in plastic and including fastening tabs.

Code	Type	Price €	Unit/Box
450 0018	H = 28 mm		100/1000



### 4540

Additive for screeds in water-based solution including acrylic polymers. It reduces hygroscopic receding and increases thermal resistance, thus improving thermal conductivity.

#### TECHNICAL SPECIFICATIONS

- Dose: 1 kg additive x 100 Kg concrete

Code	Type	Price €/kg	Unit/Box (kg)
450 0019	10 Kg ≈ 9,6 l		10/10
450 0017	25 Kg ≈ 24 l		25/25





### 4508

PE expansion joint, self-adhesive base for smooth and ashlar panels.

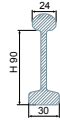

#### TECHNICAL SPECIFICATIONS

- Height: 90 mm
- Length: 2 m

Code	Type	Price €/m	Unit/Box (m)
450 0023	-		20/180

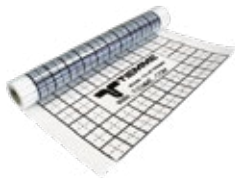

### 4503

PE moisture-proof insulating strip

#### TECHNICAL SPECIFICATIONS

- Width: 1.2 m
- Length: 100 m
- Thickness: 0.15 mm

Code	Type	Price €/m <sup>2</sup>	Unit/Box (m <sup>2</sup> )
450 0025	-		120/120

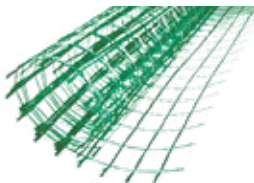

### 4532

Fiberglass mesh with anti-alkaline treatment to reinforce concrete screeds.

#### TECHNICAL SPECIFICATIONS

- Mesh size: 40 x 40 mm
- Weight: 130 g/m<sup>2</sup>

**i** 2 mm thread metal mesh upon request.

Code	Type	Price €/m <sup>2</sup>	Unit/Box (m <sup>2</sup> )
450 0152	1 m x 50 m		50/400
450 0022	1 m x 100 m		100/400



### 4539

Protects against the corrosion of metal particles with universal bactericide and fungicide for heating and cooling systems.

#### TECHNICAL SPECIFICATIONS

- Dose: 1 l additive x 100 l circulating water

Code	Type	Price €	Unit/Box
450 0486	1 l		1/12



**02A Radiant ceiling systems**

---

Radiant ceiling systems - introduction	66
--	----

---

CEILING HOME	68
--------------	----

---

**02B Radiant wall systems**

---

Radiant wall systems - introduction	82
-------------------------------------	----

---

WALL	83
------	----

---

**02C Radiant ceiling systems for service providers**

---

Radiant ceiling systems for service providers - introduction	86
--	----

---

CEILING OFFICE	87
----------------	----

---

A ceiling heating system spreads the heat in all rooms of the house due to radiation exchange between warm and cool surfaces.

## WHAT IS IT ABOUT?

Radiation is a phenomenon frequently occurring in nature, when a surface absorbs the heat contained or produced by another surface having a relatively higher surface temperature.

Similarly, the room's walls where the ceiling heating system is placed are the cool surface. It accumulates the heat produced by the ceiling liner and spread it, thus warming the environment.

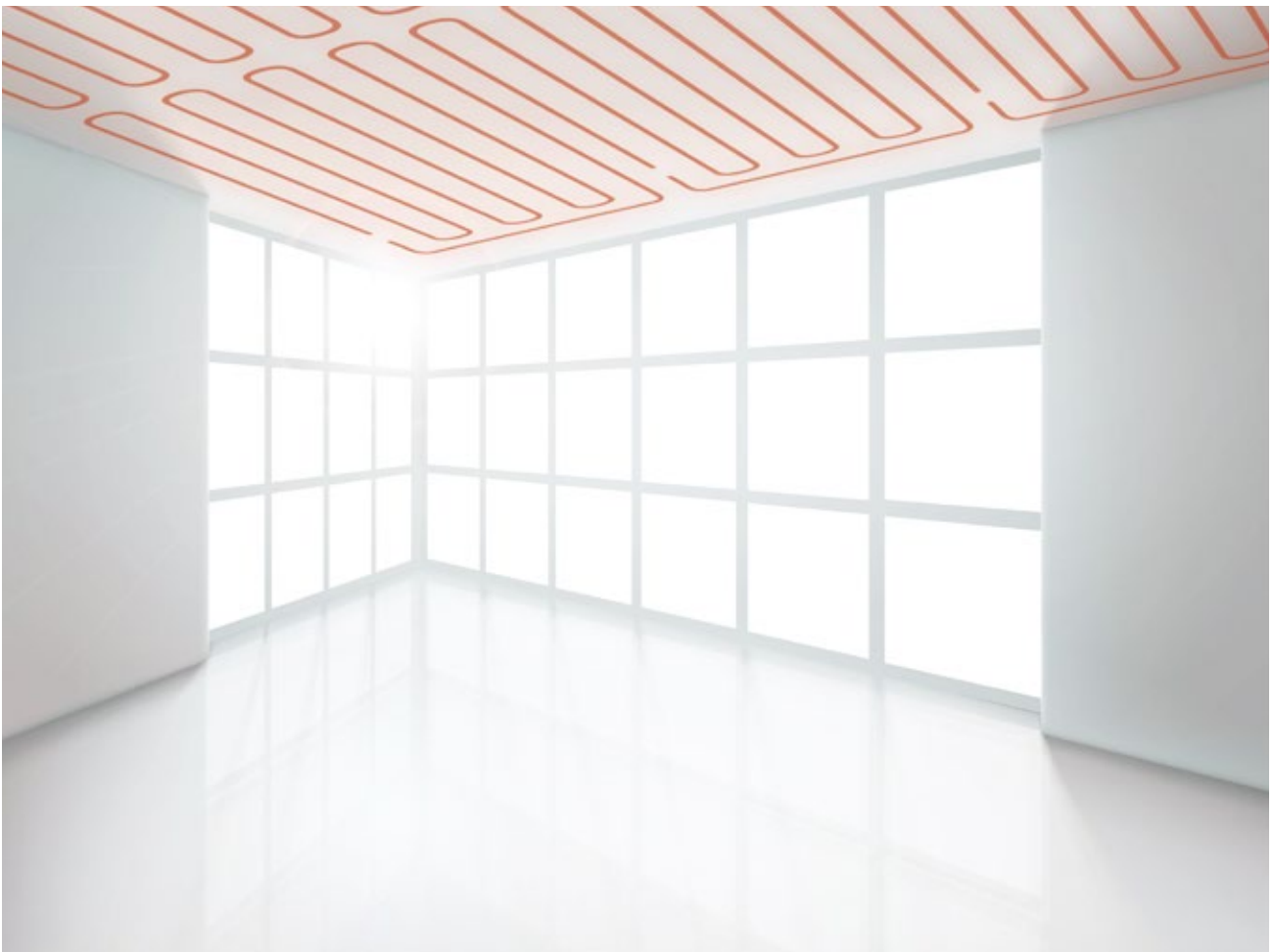



## IT DOES NOT REQUIRE MASONRY WORKS

Ceiling heating is a cost-effective solution, as the installation of radiant panels that make the system does not require demolitions or other masonry works.

## HOMOGENEOUS HEAT

The ceiling heating system provides homogeneous heating and allows balanced exchange between the environment and the radiant system. This prevents from thermal shock.

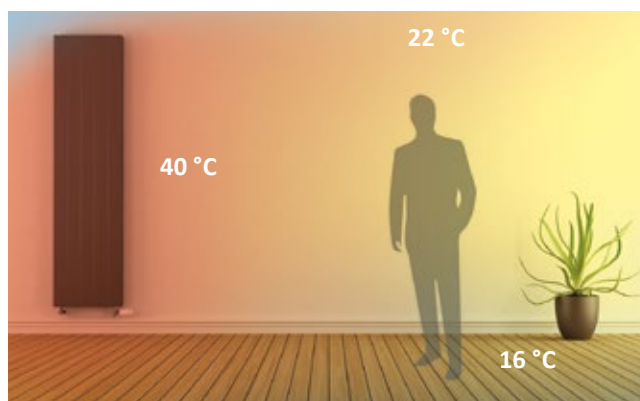

Heating system with radiators

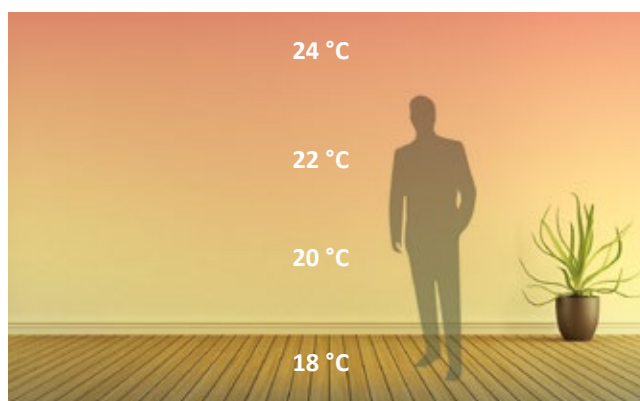

Ceiling heating system

## PRACTICAL INSTALLATION AND FLEXIBLE USAGE

Radiant panels are pre-built and assembled, and are perfect for producing both heat during cold periods and cool in warmer time.

## REDUCED DIMENSIONS

Radiant ceiling panels are an invisible heating system and occupy minor space. They are less than 50 mm thick and their installation does not create any limitation in the installation environment.

## WIDE ARCHITECTURAL COMPATIBILITY

The ceiling heating system is highly modular and integrates perfectly with the architecture, so that panels can fit any type of ceiling.

## REDUCED HUMIDITY, MOLD, AND OFF-ODORS

Heat is spread by thermal exchange, thus reducing humidity, mold, and off-odors. This feature is particularly important in the northern side of the house, where unwanted microorganisms are more likely to grow.

### PLASTERBOARD RADIANT PANEL

CEILING HOME is the pre-assembled plasterboard radiant system for wall and ceiling heating and cooling.

A modular system ready-to-install, it is perfect for winter and summer climate control. CEILING HOME fits any type of applications, from houses to service-producing sector, new systems and renovations.

Its modularity fits perfectly with space measurements, in both wall and ceiling applications, without affecting architectural features.



### HEATING AND COOLING IN THE PANEL

CEILING HOME include plasterboard panels in different shapes and models: different sizes offer maximum adaptation to a wide range of architectural needs.

Moreover, the integrated connection system speeds up installation and allows to achieve high coverage in terms of active surface.

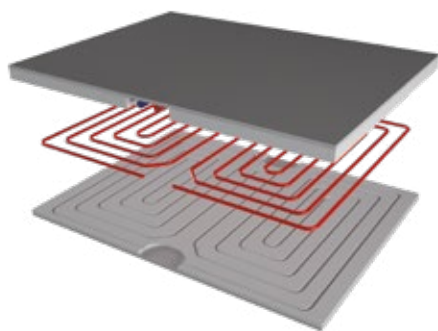

### HIGH INSULATION AND ENERGY EFFICIENCY

CEILING HOME radiant coils are placed in the plasterboard, not in the insulating layer: maximum contact between the plasterboard and the pipe increases system performance by almost 10%.

The active sheet is coupled with a high-density insulating EPS layer, within which connections are housed.

Low-temperature power supply of panels and maximum insulation make Ceiling Home the ideal solution for high energy efficiency applications.

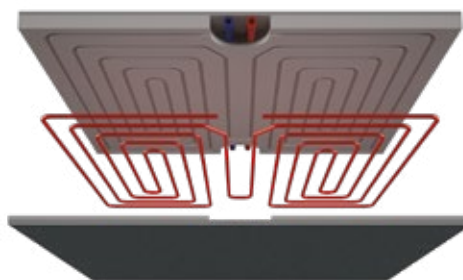

### LOW THERMAL INERTIA WITH THE PLASTERBOARD SYSTEM

CEILING HOME can be quickly operational and highly responsive to adjustment: reduced thickness of the active layer, a 15 mm plasterboard sheet, lends the system an extremely low thermal inertia.

Compared with a traditional 65 mm thick screed, CEILING HOME is 10 times faster in terms of thermal capacity-to-area of the plasterboard sheet. This enables the system to be fully operational in less than one hour.

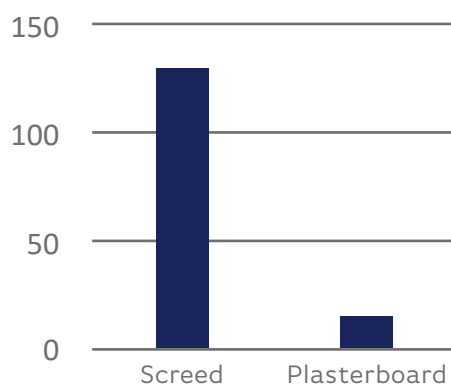

■ Heat capacity (KJ/m<sup>2</sup> K)



### EASY TO INSTALL RADIANT SYSTEMS

CEILING HOME radiant panels are pre-assembled plasterboard modules that are ready to be installed. They can be easily installed on walls and the ceiling.

Thanks to different panel sizes, CEILING HOME can be easily adapted for any type of wall or ceiling, thus guaranteeing easy, fast, and waste-free installation.

"Passive" panels, without hydraulic circuits, allow for the completion of radiant surfaces and the connection with adjacent structural elements.



### LIGHT AND EASY TO INSTALL MODULAR PANELS

Radiant plasterboard panels are pre-assembled. It is sufficient to prepare links and connect them on the manifold's trunk feed and return lines.

Characteristics:

- Light, thin, and easy to install;
- E-class fire resistance;
- Resistant to deformation at high temperature (80°C) ;
- Certified in compliance with green building guidelines;
- Tracking of radiant circuits engraved on the panel;
- Available in different sizes to avoid waste.



A solution designed for residential and commercial cooling and heating systems requiring maximum thermal performance, without any surface temperature limitation.

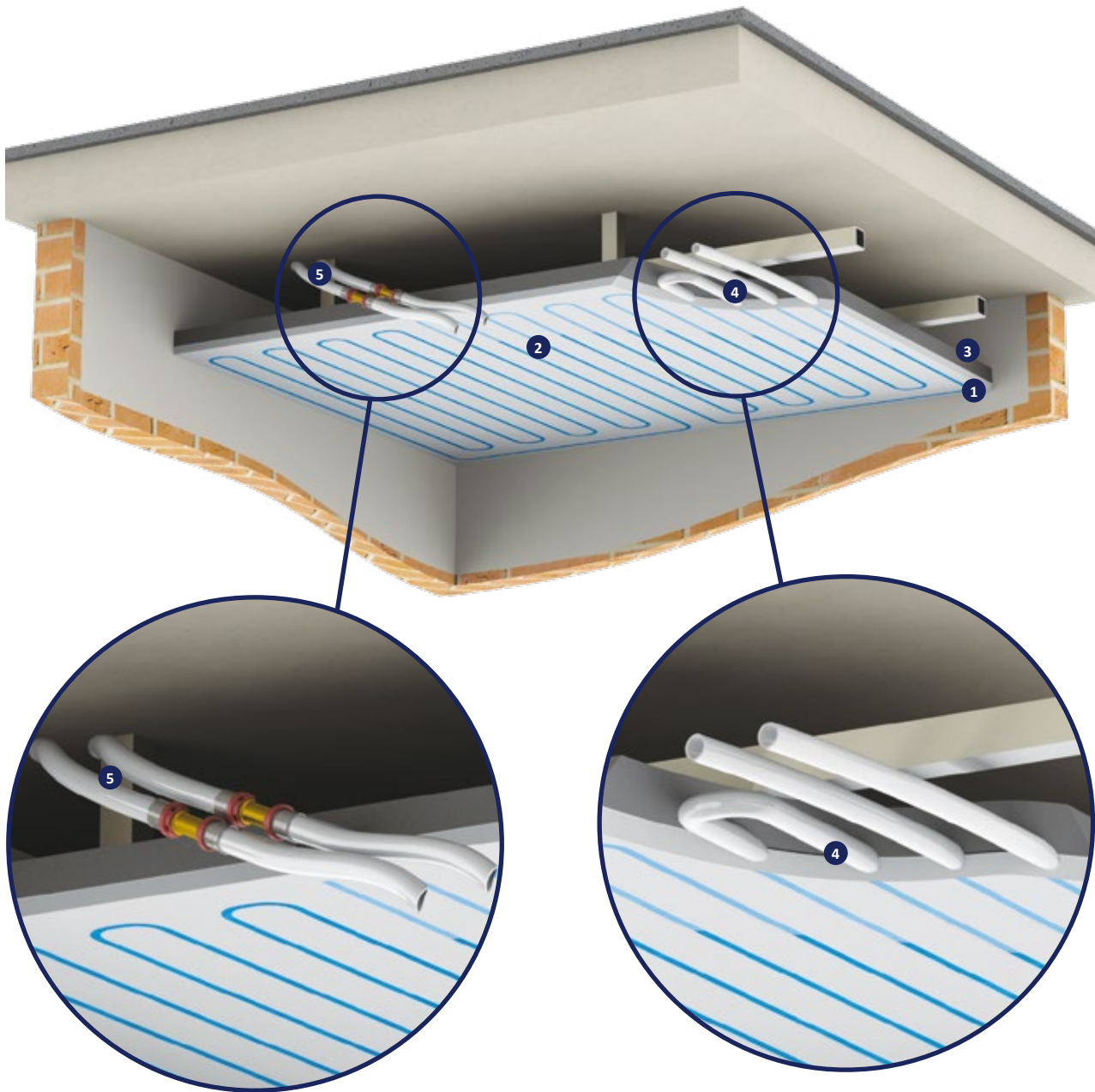

1. Plasterboard layer
2. Circuit tracking
3. Polystyrene insulating layer
4. Radiant circuit pipe COBRAPEX Ø 8x1 mm
5. Feed pipe and uprights, multilayer Ø 20x2 mm



## TIEMME SOLUTIONS

### CEILING HOME GRAPHITE 50



- EPS insulator with graphite, thickness 30 mm
- Plasterboard, thickness: 15 mm
- Radiant circuit pipe COBRAPEX Ø 8x1 mm
- Distance: 50 mm

### CEILING HOME GRAPHITE 50 - IDRO



- EPS insulator with graphite, thickness 30 mm
- Moisture proof plasterboard, 15 mm thick
- Radiant circuit pipe COBRAPEX Ø 8x1 mm
- Distance: 50 mm

### CEILING HOME GRAPHITE 30



- EPS insulator with graphite, thickness 30 mm
- Plasterboard, thickness: 15 mm
- Radiant circuit pipe COBRAPEX Ø 8x1 mm
- Distance: 30 mm

### CEILING HOME GRAPHITE 30 - IDRO

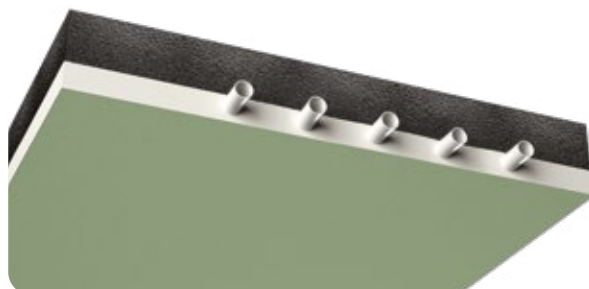

- EPS insulator with graphite, thickness 30 mm
- Moisture proof plasterboard, 15 mm thick
- Radiant circuit pipe COBRAPEX Ø 8x1 mm
- Distance: 30 mm

### CEILING HOME GRAPHITE ALU 75



- EPS insulator with graphite, 30 mm thick
- Aluminum outlets
- Plasterboard, thickness: 15 mm
- Radiant circuit pipe COBRAPEX Ø 8x1 mm
- Distance: 75 mm

### CEILING HOME GRAPHITE ALU 75 - IDRO

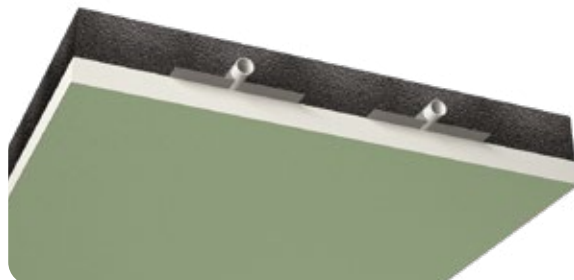

- EPS insulator with graphite, 30 mm thick
- Aluminum diffusers
- Moisture proof plasterboard, 15 mm thick
- Radiant circuit pipe COBRAPEX Ø 8x1 mm
- Distance: 75 mm

### CEILING HOME GRAPHITE 50



#### RGRF

Active radiant wall/ceiling panel, for low-temperature summer cooling systems and winter heating systems.

#### DESCRIPTION

Comprising:

- Reinforced plasterboard sheet, 15 mm thick, thermal conductivity: 0.6 W/mK
- Insulating sheet in sintered foam polystyrene with graphite, 30 mm thick, thermal conductivity: 0.030 W/mK
- Radiant coil made with a PE-Xb  $\varnothing$ 8x1 mm pipe, EN ISO 15875-2 compliant with anti-oxygen barrier, DIN 4726 compliant

#### TECHNICAL SPECIFICATIONS

- Pipe distance: 50 mm
- Total thickness: 45 mm
- Connections with multilayer pipe  $\varnothing$ 20x2 mm
- Coil drawing on the plasterboard surface for secure installation

Code	Type	Size (mm)	Price €/m <sup>2</sup>	Unit/Box (m <sup>2</sup> )
450 0577	Standard	2000 x 1200		2.4/2.4
450 0578	Standard	1000 x 1200		1.2/1.2
450 0579	Standard	600 x 2000		1.2/1.2
450 0580	Standard	600 x 1200		0.72/0.72
450 0581	Encoder	2000 x 1200		2.4/2.4
450 0582	Encoder	1000 x 1200		1.2/1.2
450 0583	Encoder	600 x 2000		1.2/1.2
450 0584	Encoder	600 x 1200		0.72/0.72

### CEILING HOME GRAPHITE 50 - IDRO

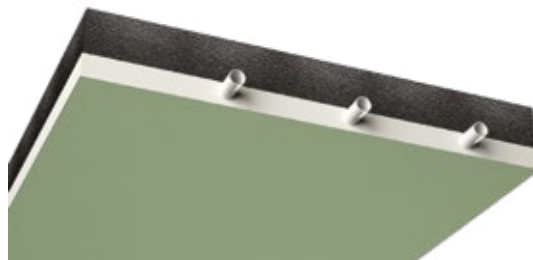

#### RGRFU

Active radiant wall/ceiling moisture proof panel, for low-temperature summer cooling systems and winter heating systems.

#### DESCRIPTION

Comprising:

- Sheet in reinforced plasterboard, 15 mm thick and moisture proof, thermal conductivity: 0.6 W/mK
- Insulating sheet in sintered foam polystyrene with graphite, 30 mm thick, thermal conductivity: 0.030 W/mK
- Radiant coil made with a PE-Xb  $\varnothing$ 8x1 mm pipe, EN ISO 15875-2 compliant with anti-oxygen barrier, DIN 4726 compliant

#### TECHNICAL SPECIFICATIONS

- Pipe distance: 50 mm
- Total thickness: 45 mm
- Connections with multilayer pipe  $\varnothing$ 20x2 mm
- Coil drawing on the plasterboard surface for secure installation

Code	Type	Size (mm)	Price €/m <sup>2</sup>	Unit/Box (m <sup>2</sup> )
450 0585	Standard	2000 x 1200		2.4/2.4
450 0586	Standard	1000 x 1200		1.2/1.2
450 0587	Standard	600 x 2000		1.2/1.2
450 0588	Standard	600 x 1200		0.72/0.72
450 0589	Encoder	2000 x 1200		2.4/2.4
450 0590	Encoder	1000 x 1200		1.2/1.2
450 0591	Encoder	600 x 2000		1.2/1.2
450 0592	Encoder	600 x 1200		0.72/0.72



### DIMENSIONS

#### DESIGN WITH STANDARD SIDES

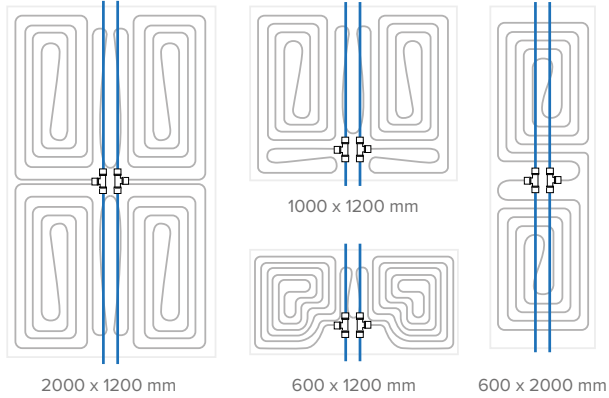

#### DESIGN WITH END BACKBONES TO BE USED AT THE END OF THE LINE

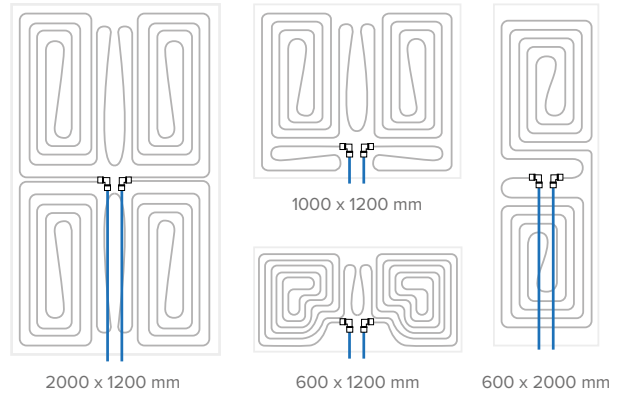

### TECHNICAL SPECIFICATIONS

	Codes			
	450 0577 450 0581 450 0585 450 0589	450 0578 450 0582 450 0586 450 0590	450 0579 450 0583 450 0587 450 0591	450 0580 450 0584 450 0588 450 0592
Insulating thickness (mm)	30			
Plasterboard thickness (mm)	15			
Total thickness (mm)	45			
Circuit piping diameter (mm)	8x1			
Backbone diameter (mm)	20x2			
Piping distance (mm)	50			
Heat conductivity UNI EN 12667 (W/mK)	0.030			
Thermal resistance EN 13163 (m <sup>2</sup> k/W)	1.00			
Euroclass reaction to fire EN 13501-1	E			
Panel total size (mm)	2000 x 1200	1000 x 1200	600 x 2000	600 x 1200
Panel surface (m <sup>2</sup> )	2.4	1.2	1.2	0.72

#### HEATING



Curves of performance certificates in compliance with prEN 14037-5:2011 in heating.

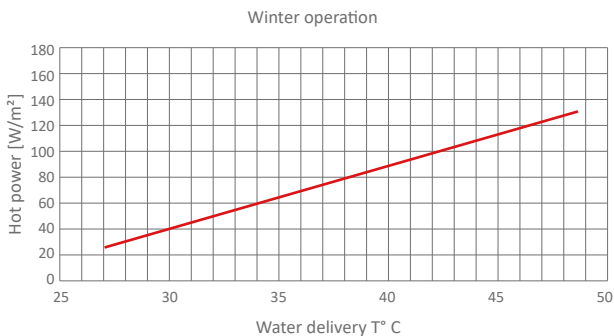

#### COOLING



Curves of performance certificates in compliance with UNI EN 14240:2005 in cooling.

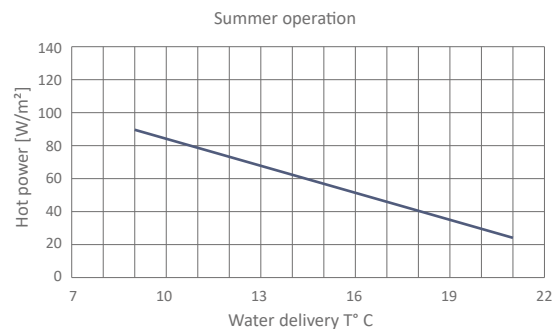

### CEILING HOME GRAPHITE 30



#### RGRF30

Active radiant wall/ceiling panel, for low-temperature summer cooling systems and winter heating systems.

#### DESCRIPTION

Comprising:

- Sheet in reinforced plasterboard, 15 mm thick, thermal conductivity: 0.6 W/mK
- Insulating sheet in sintered foam polystyrene with graphite, 30 mm thick, thermal conductivity: 0.030 W/mK
- Radiant coil made with a PE-Xb Ø8x1 mm pipe, EN ISO 15875-2 compliant with anti-oxygen barrier, DIN 4726 compliant

#### TECHNICAL SPECIFICATIONS

- Pipe distance: 30 mm
- Total thickness: 45 mm
- Connections with multilayer pipe Ø20x2 mm
- Coil drawing on the plasterboard surface for secure installation

Code	Type	Size (mm)	Price €/m <sup>2</sup>	Unit/Box (m <sup>2</sup> )
450 0609	Standard	2000 x 1200		2.4/2.4
450 0610	Standard	1000 x 1200		1.2/1.2
450 0611	Standard	600 x 2000		1.2/1.2
450 0612	Standard	600 x 1200		0.72/0.72
450 0613	Encoder	2000 x 1200		2.4/2.4
450 0614	Encoder	1000 x 1200		1.2/1.2
450 0615	Encoder	600 x 2000		1.2/1.2
450 0616	Encoder	600 x 1200		0.72/0.72

### CEILING HOME GRAPHITE 30 - IDRO

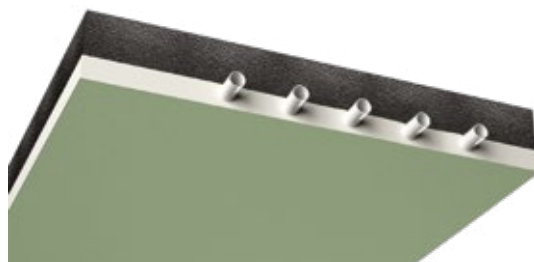

#### RGRFU30

Active radiant wall/ceiling moisture proof panel, for low-temperature summer cooling systems and winter heating systems.

#### DESCRIPTION

Comprising:

- Sheet in reinforced plasterboard, 15 mm thick and moisture proof, thermal conductivity: 0.6 W/mK
- Insulating sheet in sintered foam polystyrene with graphite, 30 mm thick, thermal conductivity: 0.030 W/mK
- Radiant coil made with a PE-Xb Ø8x1 mm pipe, EN ISO 15875-2 compliant with anti-oxygen barrier, DIN 4726 compliant

#### TECHNICAL SPECIFICATIONS

- Pipe distance: 30 mm
- Total thickness: 45 mm
- Connections with multilayer pipe Ø20x2 mm
- Coil drawing on the plasterboard surface for secure installation

Code	Type	Size (mm)	Price €/m <sup>2</sup>	Unit/Box (m <sup>2</sup> )
450 0617	Standard	2000 x 1200		2.4/2.4
450 0618	Standard	1000 x 1200		1.2/1.2
450 0619	Standard	600 x 2000		1.2/1.2
450 0620	Standard	600 x 1200		0.72/0.72
450 0621	Encoder	2000 x 1200		2.4/2.4
450 0622	Encoder	1000 x 1200		1.2/1.2
450 0623	Encoder	600 x 2000		1.2/1.2
450 0624	Encoder	600 x 1200		0.72/0.72





### DIMENSIONS

#### DESIGN WITH STANDARD BACKBONES

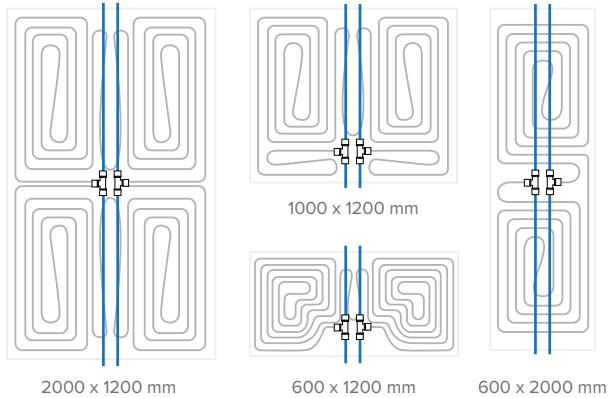

#### DESIGN WITH END BACKBONES TO BE USED AT THE END OF THE LINE

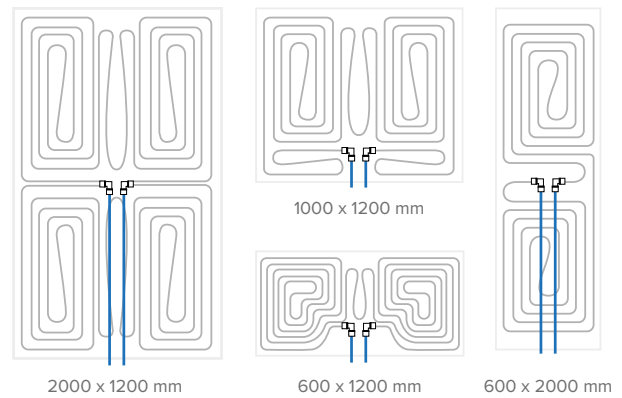

### TECHNICAL SPECIFICATIONS

	Codes			
	450 0609 450 0613 450 0617 450 0621	450 0610 450 0614 450 0618 450 0622	450 0611 450 0615 450 0619 450 0623	450 0612 450 0616 450 0620 450 0624
Insulating thickness (mm)	30			
Plasterboard thickness (mm)	15			
Total thickness (mm)	45			
Circuit piping diameter (mm)	8x1			
Backbone diameter (mm)	20x2			
Piping distance (mm)	30			
Heat conductivity UNI EN 12667 (W/mK)	0.030			
Thermal resistance EN 13163 (m <sup>2</sup> k/W)	1.00			
Euroclass reaction to fire EN 13501-1	E			
Panel total size (mm)	2000 x 1200	1000 x 1200	600 x 2000	600 x 1200
Panel surface (m <sup>2</sup> )	2.4	1.2	1.2	0.72

#### HEATING



Curves of performance certificates in compliance with prEN 14037-5:2011 in heating.

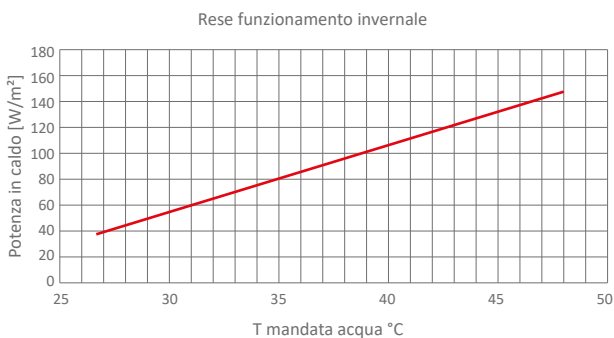

#### COOLING



Curves of performance certificates in compliance with UNI EN 14240:2005 in cooling.

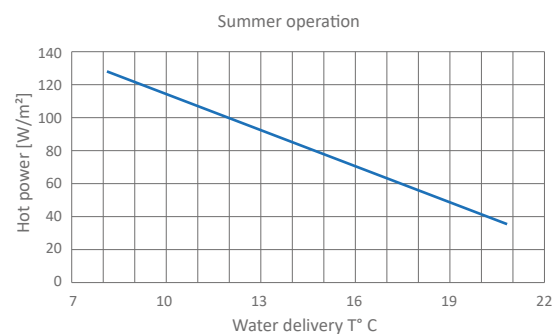

### CEILING HOME GRAPHITE ALU 75



#### RGRFAL75

Active radiant wall/ceiling panel, for low-temperature summer cooling systems and winter heating systems.

##### DESCRIPTION

Comprising:

- Sheet in reinforced plasterboard, 15 mm thick, thermal conductivity: 0.6 W/mK
- Aluminum outlets for high thermal performance
- Insulating sheet in sintered foam polystyrene with graphite, 30 mm thick, thermal conductivity: 0.030 W/mK
- Radiant coil made with a PE-Xb  $\varnothing$ 8x1 mm pipe, EN ISO 15875-2 compliant with anti-oxygen barrier, DIN 4726 compliant

##### TECHNICAL SPECIFICATIONS

- Pipe distance: 75 mm
- Total thickness: 45 mm
- Connections with multilayer pipe  $\varnothing$ 20x2 mm
- Coil drawing on the plasterboard surface for secure installation

Code	Type	Size (mm)	Price €/m <sup>2</sup>	Unit/Box (m <sup>2</sup> )
450 0593	Standard	2000 x 1200		2.4/2.4
450 0594	Standard	1000 x 1200		1.2/1.2
450 0595	Standard	600 x 2000		1.2/1.2
450 0596	Standard	600 x 1200		0.72/0.72
450 0597	Encoder	2000 x 1200		2.4/2.4
450 0598	Encoder	1000 x 1200		1.2/1.2
450 0599	Encoder	600 x 2000		1.2/1.2
450 0600	Encoder	600 x 1200		0.72/0.72

### CEILING HOME GRAPHITE ALU 75 - IDRO



#### RGRFID75U

Active radiant wall/ceiling moisture proof panel, for low-temperature summer cooling systems and winter heating systems.

##### DESCRIPTION

Comprising:

- Sheet in reinforced plasterboard, 15 mm thick and moisture proof, thermal conductivity: 0.6 W/mK
- Aluminum outlets for high thermal performance
- Insulating sheet in sintered foam polystyrene with graphite, 30 mm thick, thermal conductivity: 0.030 W/mK
- Radiant coil made with a PE-Xb  $\varnothing$ 8x1 mm pipe, EN ISO 15875-2 compliant with anti-oxygen barrier, DIN 4726 compliant

##### TECHNICAL SPECIFICATIONS

- Pipe distance: 75 mm
- Total thickness: 45 mm
- Connections with multilayer pipe  $\varnothing$ 20x2 mm
- Coil drawing on the plasterboard surface for secure installation

Code	Type	Size (mm)	Price €/m <sup>2</sup>	Unit/Box (m <sup>2</sup> )
450 0601	Standard	2000 x 1200		2.4/2.4
450 0602	Standard	1000 x 1200		1.2/1.2
450 0603	Standard	600 x 2000		1.2/1.2
450 0604	Standard	600 x 1200		0.72/0.72
450 0605	Encoder	2000 x 1200		2.4/2.4
450 0606	Encoder	1000 x 1200		1.2/1.2
450 0607	Encoder	600 x 2000		1.2/1.2
450 0608	Encoder	600 x 1200		0.72/0.72



### DIMENSIONS

#### DESIGN WITH STANDARD BACKBONES

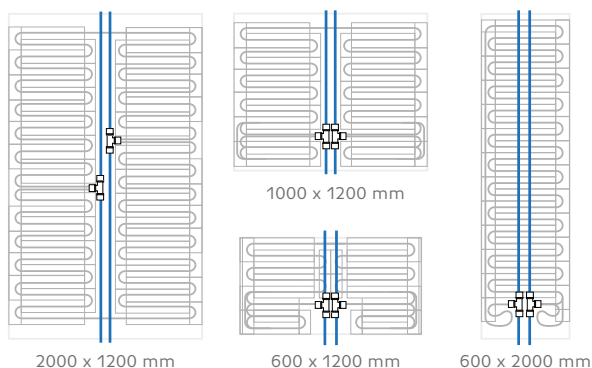

#### DESIGN WITH END BACKBONES TO BE USED AT THE END OF THE LINE

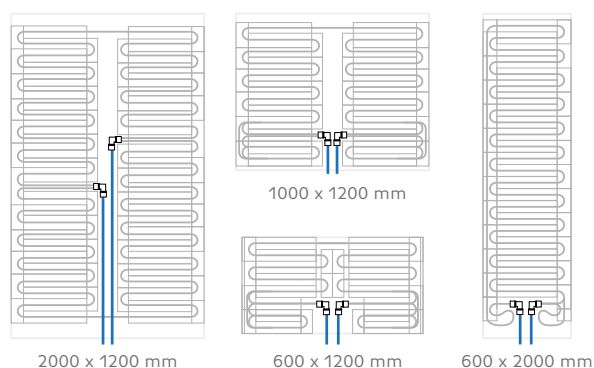

### TECHNICAL SPECIFICATIONS

	Codes			
	450 0593 450 0597 450 0601 450 0605	450 0594 450 0598 450 0602 450 0606	450 0595 450 0599 450 0603 450 0607	450 0596 450 0600 450 0604 450 0608
Insulating thickness (mm)	30			
Plasterboard thickness (mm)	15			
Total thickness (mm)	45			
Circuit piping diameter (mm)	8x1			
Backbone diameter (mm)	20x2			
Piping distance (mm)	75			
Heat conductivity UNI EN 12667 (W/mK)	0.030			
Thermal resistance EN 13163 (m <sup>2</sup> k/W)	1.00			
Euroclass reaction to fire EN 13501-1	E			
Panel total size (mm)	2000 x 1200	1000 x 1200	600 x 2000	600 x 1200
Panel surface (m <sup>2</sup> )	2.4	1.2	1.2	0.72

#### HEATING



Curves of performance certificates in compliance with prEN 14037-5:2011 in heating.

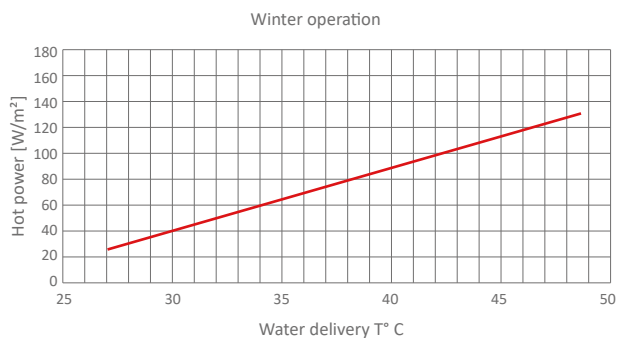

#### COOLING



Curves of performance certificates in compliance with UNI EN 14240:2005 in cooling.

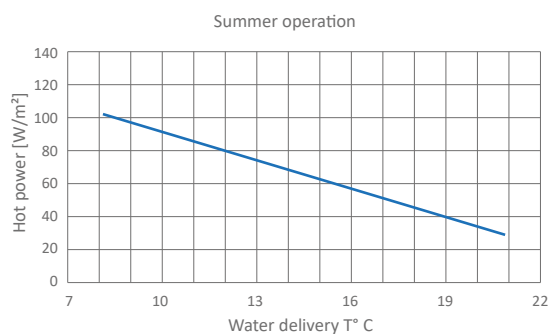

Upon request, Tiemme can provide radiant panels with specific requirements of reaction to fire. Class of surface layer's reaction to fire with special plasterboard, up to class A1. Up to A1 class of insulating layer's reaction to fire with mineral wool.

Design needs that demand special acoustic requirements are met with Tiemme SILENT solutions, which can be combined with CEILING HOME and CEILING HOME ALU radiant systems. Tiemme acoustic system is achieved with a perforated plasterboard layer coupled with visible acoustic felt and rock wool, the thickness of which can be specified by the designer.

### TIEMME SOLUTIONS

CEILING HOME FIRE

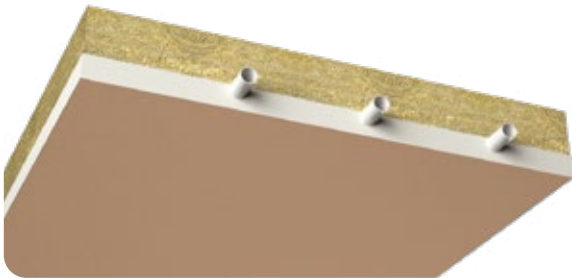

CEILING HOME SILENT

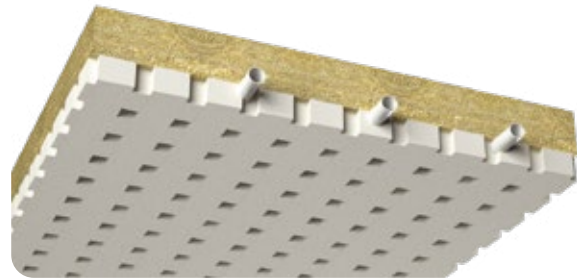

CEILING HOME ALU FIRE

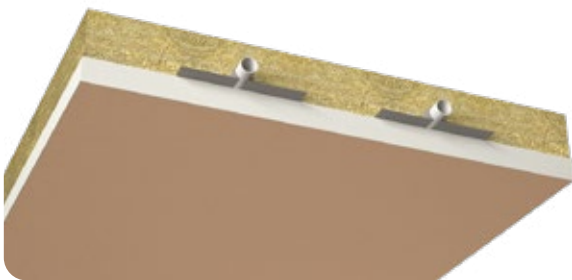

CEILING HOME ALU SILENT

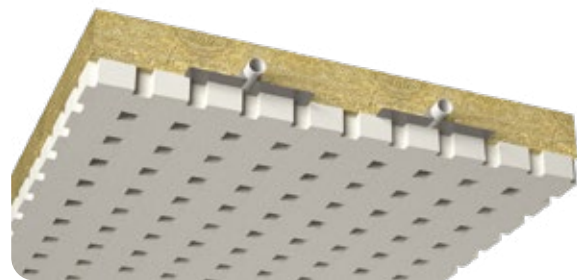

## EXAMPLE OF PROJECT

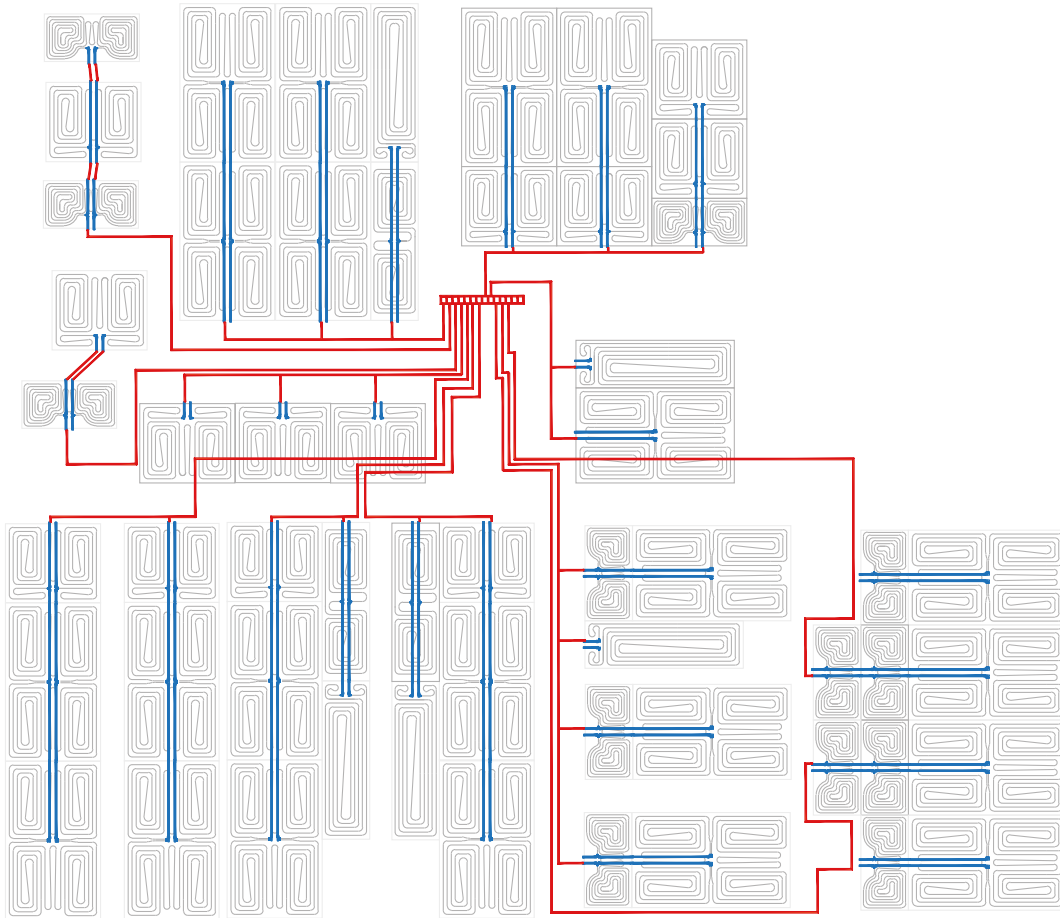

## LAYING EXAMPLE

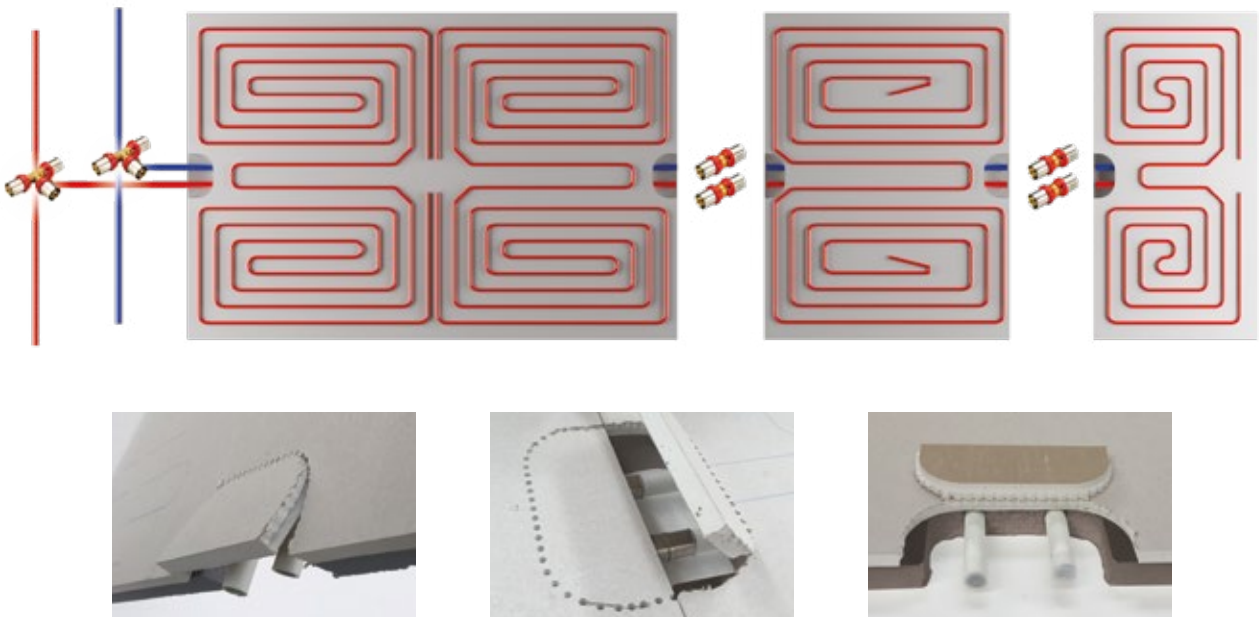



### RGN

Plasterboard infill panel for radiant ceiling and wall systems with a polystyrene insulating layer

#### DESCRIPTION:

Comprising:

- Sheet in reinforced plasterboard, 15 mm thick, thermal conductivity: 0.6 W/mK
- Insulating sheet in foam polystyrene, 30 mm thick, thermal conductivity: 0.035 W/mK

#### TECHNICAL SPECIFICATIONS:

- Total thickness: 45 mm
- Weight: 31 kg

Code	Size	Price €/m <sup>2</sup>	Unit/Box (m <sup>2</sup> )
450 0167	1200 x 2000 mm		2.4/2.4



### RGNU

Plasterboard moisture proof infill panel for radiant ceiling and wall systems with a polystyrene insulating layer

#### DESCRIPTION:

Comprising:

- Sheet in reinforced plasterboard, 15 mm thick and moisture proof, thermal conductivity: 0.6 W/mK
- Insulating sheet in foam polystyrene, 30 mm thick, thermal conductivity: 0.035 W/mK

#### TECHNICAL SPECIFICATIONS:

- Total thickness: 45 mm
- Weight: 31 kg

Code	Size	Price €/m <sup>2</sup>	Unit/Box (m <sup>2</sup> )
450 0425	1200 x 2000 mm		2.4/2.4



### 3670

Y strainer

#### TECHNICAL SPECIFICATIONS:

- Degree of filtration: 350 µm to 600 µm depending on the diameter
- Body material: brass C W 617N
- Max operating pressure: 20 bar up to 2"
- Max operating temperature: 100°C
- Connection thread: female/female ISO 228

Code	Type	Price €	Unit/Box
367 0001	3/4"		18/54
367 0002	1"		10/30
367 0005	1"1/4		4/16
367 0009	1"1/2		3/12
367 0004	2"		2/8

With holes for applying a lead seal



### 5570

Automatic deaerator to expel air bubbles or micro bubbles with insulation.

#### TECHNICAL SPECIFICATIONS

- Body: brass
- Internal components: stainless steel
- Insulation shell: EPP
- Operating temperature range: - 10 °C ÷ + 120 °C
- Max operating pressure: 10 bar

Code	Type	Price €	Unit/Box
556 0001	3/4"		1/1
556 0002	1"		1/3
556 0003	1"1/4		1/3
556 0004	1"1/2		1/3
556 0395	2"		1/3

Without insulation



### 4539

Protects against the corrosion of metal particles with universal bactericide and fungicide for heating and cooling systems.

#### TECHNICAL SPECIFICATIONS

- Dose: 1 l additive x 100 l circulating water

Code	Type	Price €	Unit/Box
450 0486	1 l		1/12





**1651**  
Double straight connection

*i* Available in tin-plated design upon request

Code	Type	Price €	Unit/Box
165 0022	20 x 20		10/100



**1653**  
Double curve connection

*i* Available in tin-plated design upon request

Code	Type	Price €	Unit/Box
165 0006	20 x 20		10/100



**1657**  
T-shaped fitting

*i* Available in tin-plated design upon request

Code	Type			Price €	Unit/Box
	1	2	3		
165 0005	20	20	20		5/50

*i* For the complete range, please refer to the Hydraulic components catalog.

## 02<sub>B</sub> RADIANT WALL SYSTEMS - INTRODUCTION

Radiant wall systems are the perfect solutions for all those situations where a floor system cannot be installed or does not guarantee an adequate radiant surface, requiring an additional heating surface.

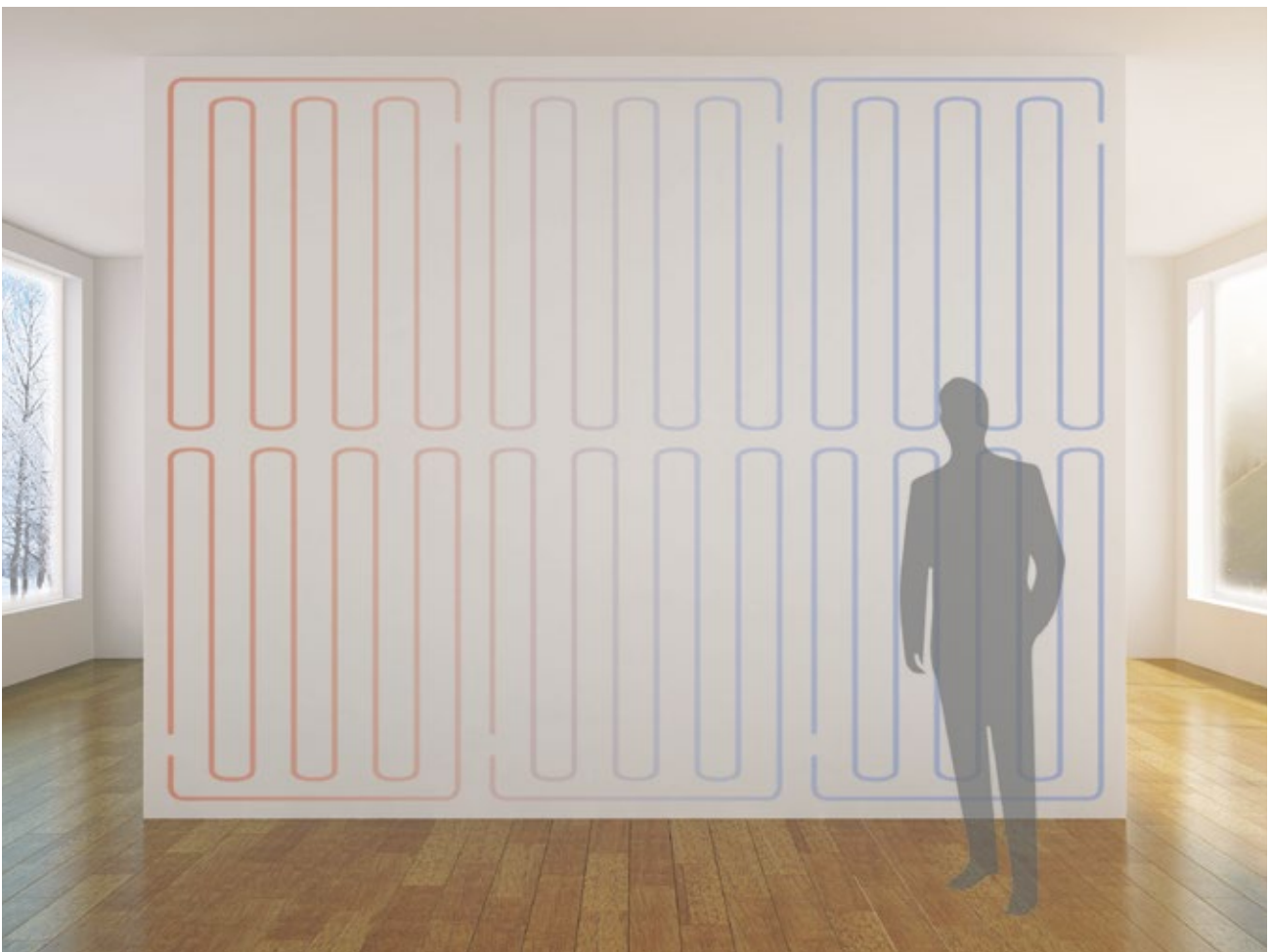



Solution specifically designed for residential and commercial heating and cooling systems where a radiant floor system cannot be installed or requires integrations.

WALL system includes modular radiant panels pre-assembled and connected with convenient fittings.

All panels have a foam polystyrene insulating layer and further space that can be used for an additional insulation shell on the plasterboard back.

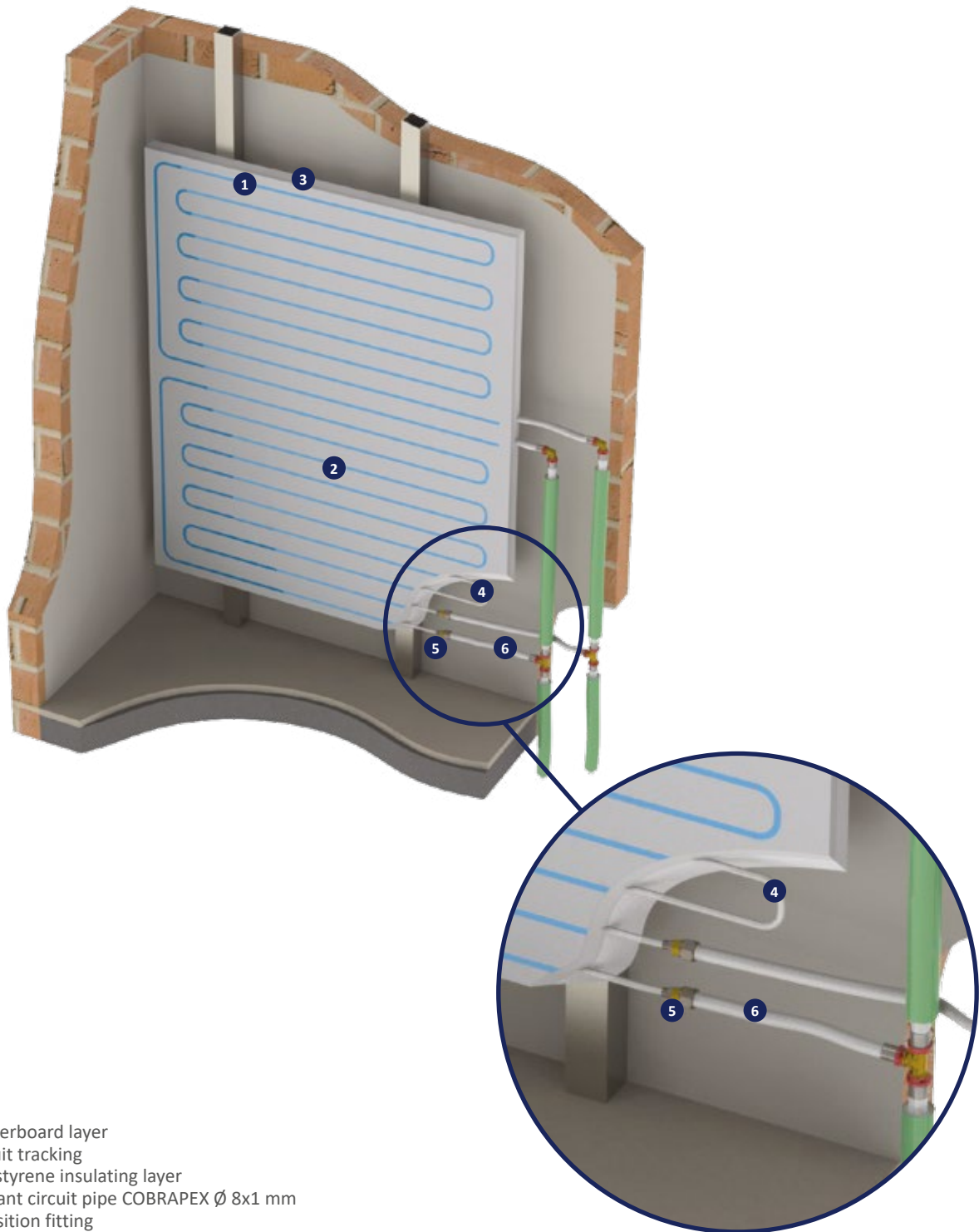



### RG

Plasterboard radiant panel for radiant ceiling and wall systems with a polystyrene insulating layer.

#### DESCRIPTION

Comprising:

- Sheet in reinforced plasterboard, 15 mm thick, thermal conductivity: 0.6 W/mK
- Insulating sheet in foam polystyrene, 30 mm thick, thermal conductivity: 0.035 W/mK
- Ø8x1 radiant coil made in EN ISO 15875-2 compliant PE-Xb with DIN 4726 compliant anti-oxygen barrier
- Internal patented transition fitting for connections made in EN ISO 21003 compliant AL-COBRAPEX ø16x2 mm multilayer pipe to ease hydraulic connection

#### TECHNICAL SPECIFICATIONS

- Total thickness: 45 mm
- Coil drawing on the plasterboard surface for secure installation

Code	Size (mm)	Price €/m <sup>2</sup>	Unit/Box (m <sup>2</sup> )
450 0170	600 x 1000		0.6/0.6
450 0161	1200 x 1000		1.2/1.2
450 0166	600 x 2000		1.2/1.2
450 0165	1200 x 2000		2.4/2.4

### THERMAL PERFORMANCE OF RADIANT PANELS IN COMPLIANCE WITH UNI EN 15377\*

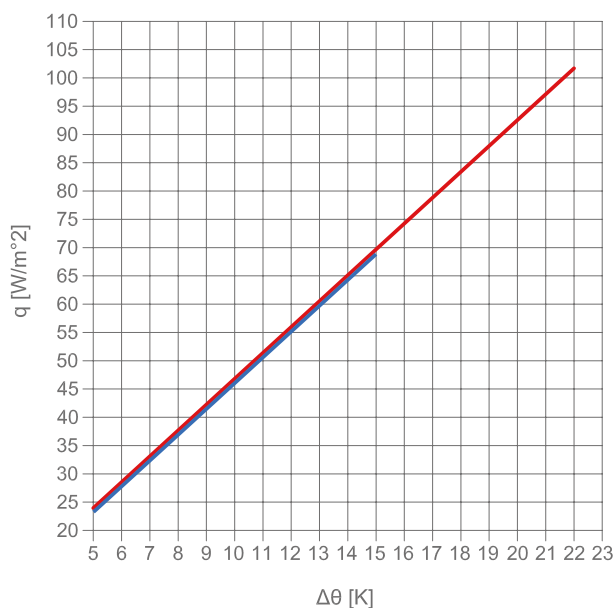

- — Wall heating
- — Wall cooling
- Δθ (K): Thermal gradient between the average temperature of the radiant surface and room temperature

\* Performance certified by the the Department of Technical Physics of the University of Padua

### TECHNICAL SPECIFICATIONS

	Codes			
	450 0170	450 0161	450 0166	450 0165
Insulating thickness (mm)	30			
Plasterboard thickness (mm)	15			
Total thickness (mm)	45			
Circuit piping diameter (mm)	8 x 1			
Heat conductivity UNI EN 12667 (W/mK)	0.035			
Thermal resistance EN 13163 (m <sup>2</sup> k/W)	0.86			
Euroclass reaction to fire EN 13501-1	E			
Panel total size (mm)	600 x 1000	1200 x 1000	600 x 2000	1200 x 2000
Panel surface (m <sup>2</sup> )	0.6	1.2	1.2	2.4





### RG N

Plasterboard infill panel for radiant ceiling and wall systems with a polystyrene insulating layer

#### DESCRIPTION:

Comprising:

- Sheet in reinforced plasterboard, 15 mm thick, thermal conductivity: 0.6 W/mK
- Insulating sheet in foam polystyrene, 30 mm thick, thermal conductivity: 0.035 W/mK

#### TECHNICAL SPECIFICATIONS:

- Total thickness: 45 mm
- Weight: 31 kg

Code	Size	Price €/m <sup>2</sup>	Unit/Box (m <sup>2</sup> )
450 0167	1200 x 2000 mm		2.4/2.4



### 3670

Y strainer

#### TECHNICAL SPECIFICATIONS:

- Degree of filtration: 350 µm to 600 µm depending on the diameter
- Body material: brass C W 617N
- Max operating pressure: 20 bar up to 2"
- Max operating temperature: 100°C
- Connection thread: female/female ISO 228

Code	Type	Price €	Unit/Box
367 0001	3/4"		18/54
367 0002	1"		10/30
367 0005	1" 1/4		4/16
367 0009	1" 1/2		3/12
367 0004	2"		2/8

With holes for applying a lead seal



### 5570

Automatic deaerator to expel air bubbles or micro bubbles with insulation.

#### TECHNICAL SPECIFICATIONS

- Body: brass
- Internal components: stainless steel
- Insulation shell: EPP
- Operating temperature range: - 10 °C ÷ + 120 °C
- Max operating pressure: 10 bar

Code	Type	Price €	Unit/Box
556 0001	3/4"		1/1
556 0002	1"		1/3
556 0003	1" 1/4		1/3
556 0004	1" 1/2		1/3
556 0395	2"		1/3

Without insulation



### 4539

Protects against the corrosion of metal particles with universal bactericide and fungicide for heating and cooling systems.

#### TECHNICAL SPECIFICATIONS

- Dose: 1 l additive x 100 l circulating water

Code	Type	Price €	Unit/Box
450 0486	1 l		1/12



### 1651

Double straight connection

*i* Available in tin-plated design upon request

Code	Type	Price €	Unit/Box
165 0016	16 x 16		10/100



### 1653

Double curve connection

*i* Available in tin-plated design upon request

Code	Type	Price €	Unit/Box
165 0011	16 x 16		10/100



### 1657

T-shaped fitting

*i* Available in tin-plated design upon request

Code	Type	Price €	Unit/Box
	1 2 3		
165 0002	16 x 16 x 16		10/50

*i* For the complete range, please refer to the Hydraulic components catalog.

Tiemme developed a range of radiant ceiling systems designed for offices, schools, commercial business or any other situation pertaining to service provisions.

Tiemme system department has a strong expertise in designing and advising service providers, and guarantees support from the very early stages of design to the selection of the most suitable products, to the execution, right through to support provided on the construction site.



A solution designed for commercial cooling and heating systems requiring maximum thermal performance, without any surface temperature limitation.

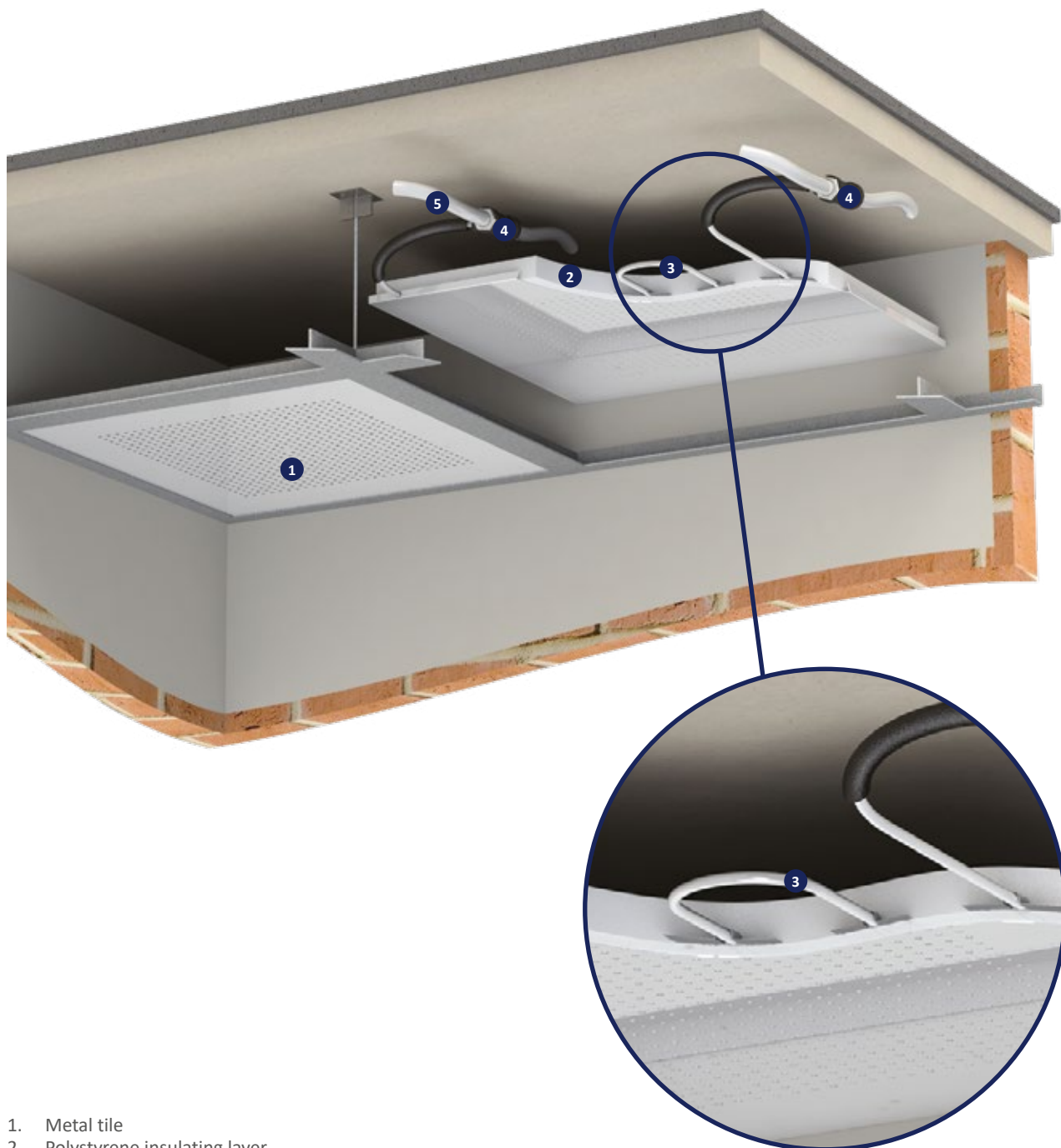

1. Metal tile
2. Polystyrene insulating layer
3. Pex  $\varnothing 12 \times 1.1$  mm pipe
4. T-shaped distributor
5.  $\varnothing 16 \times 2$  mm multilayer pipe



### SK600PL

Radiant panel in micro-perforated aluminum for radiant ceiling systems with a polystyrene insulating layer, painted white.

#### DESCRIPTION

Comprising:

- Aluminum metal tile, painted white, th 0.6 mm
- Insulating layer in foam polystyrene, 30 mm thick, thermal conductivity: 0.0389 W/mK
- Ø12x1.1 radiant coil made in EN ISO 15875-2 compliant PE-Xb with DIN 4726 compliant anti-oxygen barrier
- Aluminum outlets for improved thermal exchange

#### TECHNICAL SPECIFICATIONS

- Total thickness: 45 mm
- Coil drawing on the plasterboard surface for secure installation

Code	Size (mm)	Price €	Unit/Box
450 0680	600 x 600		1/1

### THEMAL PERFORMANCE OF RADIANT PANELS IN COMPLIANCE WITH UNI EN 15377\*

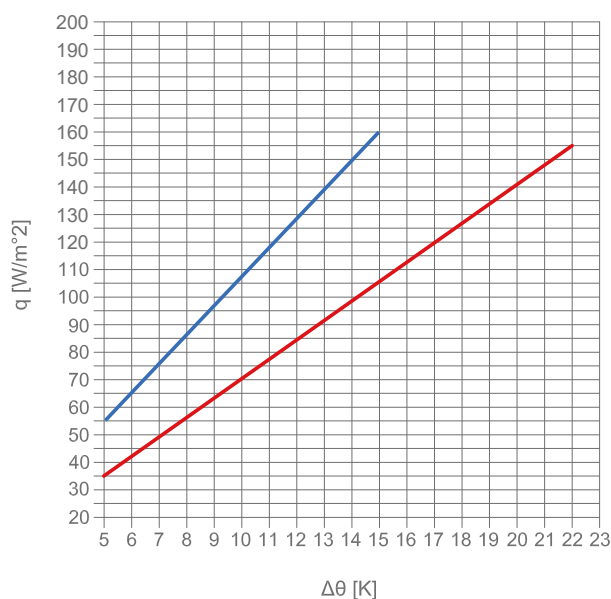

- — Wall heating
- — Wall cooling
- Δθ (K): Thermal gradient between the average temperature of the radiant surface and room temperature

\* Performance certified by the the Department of Technical Physics of the University of Padua

### TECHNICAL SPECIFICATIONS

	Codes
	450 0680
Insulating thickness (mm)	30
Aluminum thickness (mm)	0.6
Total thickness (mm)	30.6
Circuit piping diameter (mm)	12x1.1
Backbone diameter (mm)	20x2
Piping distance (mm)	75
Heat conductivity UNI EN 12667 (W/mK)	0.0389
Thermal resistance EN 13163 (m²k/W)	0.86
Euroclass reaction to fire EN 13501-1	E
Panel total size (mm)	600 x 600
Panel surface (m²)	0.36





**SK600PLN**  
Aluminum micro-perforated infill panel for radiant ceiling systems, painted white and insulated

**TECHNICAL SPECIFICATIONS**

- Total thickness: 30.6 mm

Code	Size (mm)	Price €	Unit/Box
450 0494	600 x 600		1/1



**0200B**  
COBRAPEX cross-linked polyethylene high density pipe with EVOH anti-oxygen barrier

Code	Type	Price €/m	Unit/Box (m)
020 0127	12 x 1.1		50/2400
020 0041	12 x 1.1		100/3000



**3670**  
Y strainer

**TECHNICAL SPECIFICATIONS:**

- Degree of filtration: 350 µm to 600 µm depending on the diameter
- Body material: brass C W 617N
- Max operating pressure: 20 bar up to 2"
- Max operating temperature: 100°C
- Connection thread: female/female ISO 228

Code	Type	Price €	Unit/Box
367 0001	3/4"		18/54
367 0002	1"		10/30
367 0005	1"1/4		4/16
367 0009	1"1/2		3/12
367 0004	2"		2/8

With holes for applying a lead seal



**5570**  
Automatic deaerator to expel air bubbles or micro bubbles with insulation.

**TECHNICAL SPECIFICATIONS**

- Body: brass
- Internal components: stainless steel
- Insulation shell: EPP
- Operating temperature range: - 10 °C ÷ + 120 °C
- Max operating pressure: 10 bar

Code	Type	Price €	Unit/Box
556 0001	3/4"		1/1
556 0002	1"		1/3
556 0003	1"1/4		1/3
556 0004	1"1/2		1/3
556 0395	2"		1/3

Without insulation



**4539**  
Protects against the corrosion of metal particles with universal bactericide and fungicide for heating and cooling systems.

**TECHNICAL SPECIFICATIONS**

- Dose: 1 l additive x 100 l circulating water

Code	Type	Price €	Unit/Box
450 0486	1 l		1/12



**5581**  
Double straight brass press connection

*i* Ø12 connection for PEX piping

Code	Type	Price €	Unit/Box
556 0388	12 x 12		10/100



**5581T**  
T-shaped brass press distributing connection

*i* Ø12 connection for PEX piping  
Ø20 connection for multilayer piping

Code	Type	Price €	Unit/Box
556 0386	20 x 12 x 20		5/50



**5581C**  
Double line T-shaped brass press distributing connection

*i* Ø12 connection for PEX piping  
Ø20 connection for multilayer piping

Code	Type	Price €	Unit/Box
556 0387	20 x 12 x 12 x 20		5/50



**1677**  
Brass press end connection

*i* Ø20 connection for multilayer piping

Code	Type	Price €	Unit/Box
165 0216	20		10/100



**1695TM03**  
MINI battery crimping machine  
pipe size from Ø 14 up to Ø 32

*i* The plastic box supplied with the crimp machine includes: rechargeable battery Li-Ion 12Vdc - 2,0 Ah, battery recharger, set of jaws Ø 16, Ø 20, Ø 26 (if expected)

Code	Jaws	Price €	Unit/Box
159 0089	not included		1/1



**1681MINI**  
TH profile- TIEMME customized pliers for MINI pressing machine.

Code	Type	Price €	Unit/Box
159 0128	12		1/1
159 0027	20		1/1

*i* For the complete equipment range, please refer to the Hydraulic components catalog.







**EFFICIENT SOLUTIONS FOR  
MODERN BUILDINGS**



**WE GUARANTEE HIGH COMFORT**  
Heating and cooling applications that improve thermal performance and guarantee high comfort, due to modules' micro-perforation.

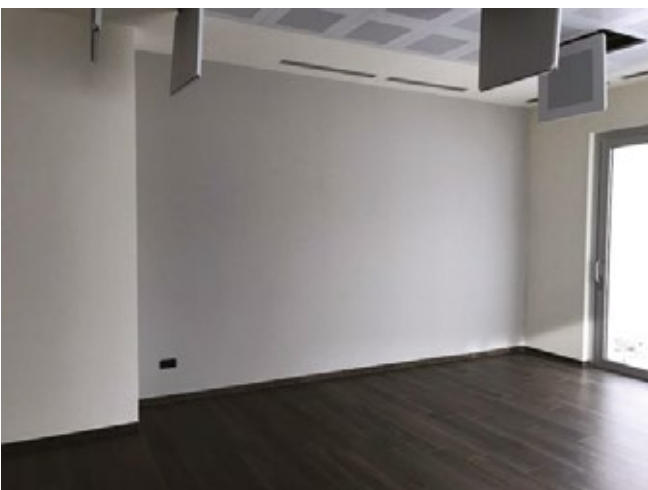

**WE TAKE CARE OF MAINTENANCE**  
Maintenance is extremely easy, due to the possibility to check single panels. Interventions are also possible during system operation.



**03A Radiant systems for industrial purposes**

---

Radiant systems for industrial purposes - introduction	94
--	----

---

STRONG RAIL	96
-------------	----

---

STRONG NET	99
------------	----

---

**03B Accessories for radiant floor systems** 101

---

Nowadays radiating floor heating is the best way to heat significantly high and large warehouses, sheds, and industrial buildings.

It is an efficient system in terms of both energy and resistance to stress resulting from a high flow rate.

Tiemme is a leading company in the design and production of radiant systems for industrial purposes.

## TIEMME SOLUTIONS

### STRONG RAIL

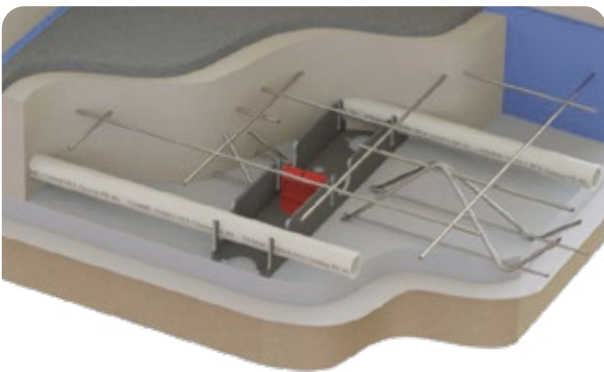

### STRONG NET

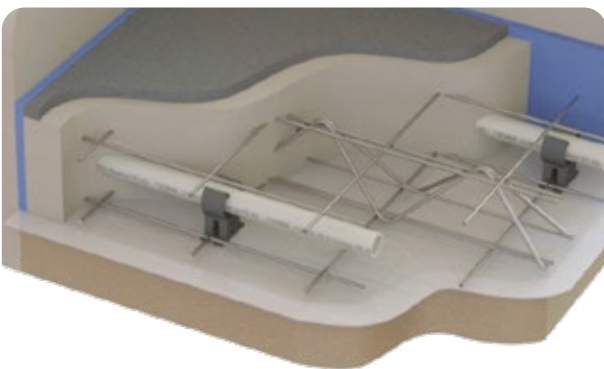

### ENERGY SAVINGS

Heating a very large environment with a radiant floor system considerably reduces management costs. Compared with air systems, it allows to save up to 50% of fuel. Using the entire floor area as a radiator, the industrial system allow to operate at low temperatures, thus benefiting from low-temperature and condensing heat generators.

Moreover, the heat transferred to the floor via radiation concentrates in the areas where the user tends to spend more time and not close to the roof, where it would be useless. Compared with an air system, which creates stratification phenomena, a radiant floor heating system creates a linear thermal gradient, so that temperature tends to decrease in the highest area of the structure.

These features allow to considerably reduce heat losses by transmission, due to a significantly lower temperature gap between the interior and exterior environment close to dispersing structures and coverings. The significant reduction of thermal dispersion enables the installation of a heat generator of a much lower power compared with other systems, maintaining better levels of comfort. The use of a lower thermal power implies the reduction of the flow rate required by the system and, as a consequence, of the diameters of the piping feeding the manifolds, as well as circulating pump features. Another critical factor impacting energy savings is the fact that due to low temperatures, the radiant system is able to take advantage of the heat coming for alternative sources, thus resulting in a further reduction of heating costs and enabling to write off in a short time initial installation costs, which are slighter higher compared with other types of systems.



## COMFORT

Due to smooth heat distribution, a radiant system creates an extremely comfortable environment. Heat is generated gradually and smoothly, and is thus perceived by the human body in a very natural way: the exchange between the source and the environment occurs by radiation and heat perception is similar to the perception of solar heat.

Heat radiating from the floor concentrates where it is needed and creates a physiologically optimal climate for the human body, resulting in improved working conditions in terms of thermal comfort. For this reason, radiant technology is increasingly spreading in the industrial sector.

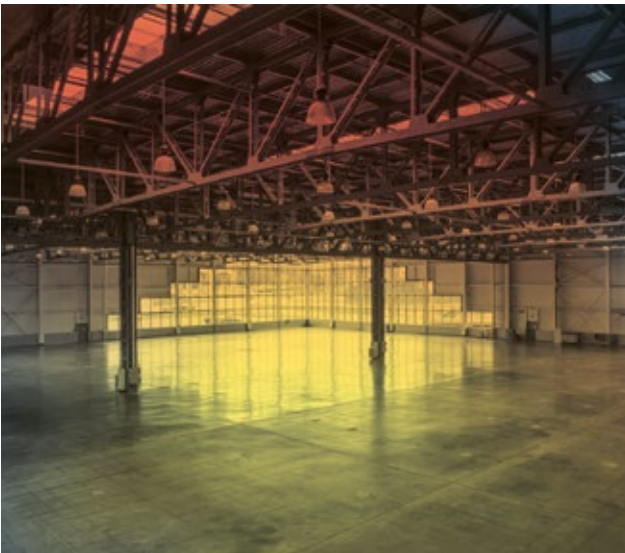

Thermography with traditional heating system



Thermography with floor heating system

## FIRE AND SAFETY

Most times industrial warehouses host productive processes involving highly inflammable materials. Even in this case, a radiant floor heating system brings evident benefits: the absence of high temperature heating components is a factor that positively affects the safety of the working environment.

## MAINTENANCE

The low-temperature heat transfer medium prevents from a high solicitation of the different components of the industrial heating system (heat generators, piping, fittings, gaskets). Moreover, a floor-integrated system results in a further reduction of maintenance costs.

## ABSENCE OF AIR CONVECTION

Traditional air-based heating systems generate large temperature gaps between the heating bodies and the air, thus resulting in unpleasant convection. On the contrary, with a radiant panel heating system, the difference between the temperature of the floor and that of the adjacent air is about 5°C, which is not enough to cause convection and, as a consequence, drifting dust. Moreover, the absence of high temperature heating bodies allows to avoid the combustion of air dust, thus reducing the risk of allergies and guaranteeing healthy environments and optimal hygienic conditions.

## USE OF ALTERNATIVE ENERGY

The large exchange surface of a floor heating system allows to operate with a low-temperature heat transfer medium. The system can therefore gather and use the heat resulting from processing phases, heat pumps, solar energy, springwater, etc., thus reducing (even down to zero) heating-related costs.

The ideal solution for industrial cooling and heating systems. The smooth panel in extruded polystyrene is specifically designed for systems requiring high flow rates.

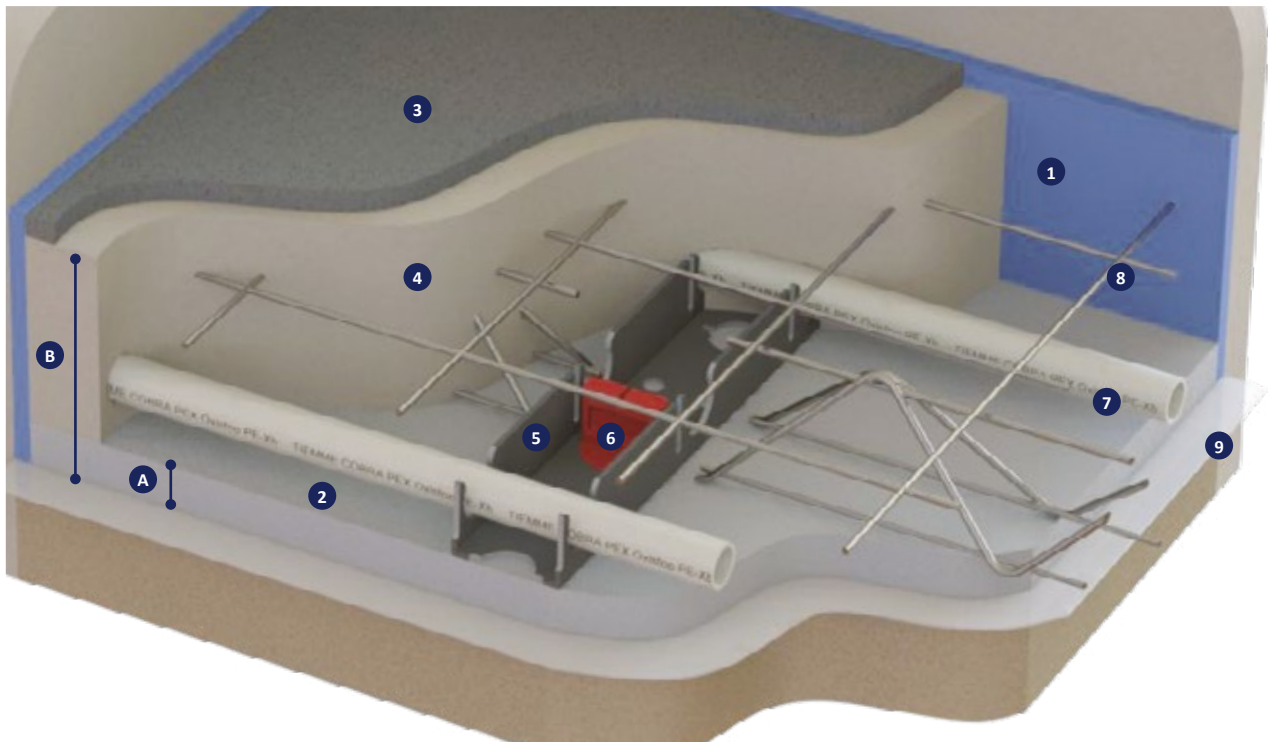

- |                         |                   |
|-------------------------|-------------------|
| 1. Perimetral band      | <b>art.4507</b>   |
| 2. Insulating panel     | <b>art.450XPS</b> |
| 3. Industrial floor     | -                 |
| 4. Screed               | -                 |
| 5. Track                | <b>art.4516</b>   |
| 6. Clip to fasten track | <b>art.4526</b>   |
| 7. Pipe                 | <b>art.0200B</b>  |
| 8. Electro-welded mesh  | -                 |
| 9. PE strip             | <b>art.4503</b>   |

Code	Size (mm)	
	A	B
450 0151	30	180 ÷ 230
450 0163	40	190 ÷ 240
450 0164	50	200 ÷ 250





### 450XPS

High compressive strength thermal insulating panel in XPS extruded polystyrene

Code	Thickness (mm)	Price €/m <sup>2</sup>	Unit/Box (m <sup>2</sup> )	Unit/Box (no. panels)
450 0151	30		10.5/126	14
450 0163	40		6.75/94.5	9
450 0164	50		6/72	8

### TECHNICAL SPECIFICATIONS

	Codes		
	450 0151	450 0163	450 0164
<b>Thermal resistance EN 13164 (m<sup>2</sup>K/W)</b>	<b>0.90</b>	<b>1.20</b>	<b>1.40</b>
10% compressive strength UNI EN 826 (kPa)	300		
Insulating thickness (mm)	30	40	50
Total thickness (mm)	30	40	50
<b>Total equivalent thickness UNI EN 1264/3 (mm)</b>	<b>30</b>	<b>40</b>	<b>50</b>
Minimum pipe distance (mm)	50		
Heat conductivity UNI EN 12667 (W/mK)	0.033	0.033	0.035
Density (kg/m <sup>3</sup> )	35		
Water absorption UNI EN 12087 (%)	0.7		
Euroclass reaction to fire EN 13501-1	E		
Resistance factor to water vapor spreading (μ)	150		
Panel total size (mm)	1270 x 620		
Usable panel size (mm)	1250 x 600		
Usable panel surface (m <sup>2</sup> )	0.75		
Panels per pack (n)	14	9	8
Panel surface per pack (m <sup>2</sup> )	10.5	6.75	6



### 0200B

COBRAPEX cross-linked polyethylene high density pipe with EVOH anti-oxygen barrier.

#### TECHNICAL FEATURES

- Max operating temperature: 95 °C
- Thermal conductivity: 0,38 W/mk
- EN ISO 15875-2 compliant
- EVOH, DIN 4726 compliant anti-oxygen barrier
- Composition: PE-Xb

Code	Type	Price €/m	Unit/Box (m)
020 0011	20 x 2.0		120/2160
020 0012	20 x 2.0		300/2400
020 0004	20 x 2.0		500/2500
020 0009	25 x 2.3		300/1500



### 4507

Perimetral band in PE foam with adhesive back and mortar containment PE strip.

Code	Type	Price €/m	Unit/Box (m)
450 0030	H 250 x 8 mm		50/150



### 1480P

90° plastic elbow to protect and support COBRAPEX pipe near the connection to the distribution manifold.

Code	Type	Price €	Unit/Box
034 0078	pipe Ø20 - 22		25/100
034 0079	pipe Ø25		25/100



### 4526

Screw plastic gripper to fasten the U-shaped track art.4516

Code	Type	Price €	Unit/Box
450 0174	-		100/100



### 4516

U-shaped plastic track to guide and fasten piping.

#### TECHNICAL FEATURES

- Bar length:
  - 2 m (code 450 0308)
  - 4 m (code 450 0173)
- Lifting: 5 mm

Code	Type	Price €	Unit/Box
450 0308	Pipe Ø 20		32/896
450 0173	Pipe Ø 25		50/50



### 4540

Additive for screeds in water-based solution including acrylic polymers. It reduces hygroscopic receding and increases thermal resistance, thus improving thermal conductivity.

#### TECHNICAL FEATURES

- Dose: 1 kg additive x 100 Kg concrete

Code	Type	Price €/kg	Unit/Box (kg)
450 0019	10 Kg ≈ 9,6 l		10/10
450 0017	25 Kg ≈ 24 l		25/25



### 4503

PE moisture-proof insulating strip

#### TECHNICAL FEATURES

- Width: 1.2 m
- Length: 100 m
- Thickness: 0.15 mm

Code	Type	Price €/m <sup>2</sup>	Unit/Box (m <sup>2</sup> )
450 0025	-		120/120



### 4539

Protects against the corrosion of metal particles with universal bactericide and fungicide for heating and cooling systems.

#### TECHNICAL FEATURES

- Dose: 1 l additive x 100 l circulating water

Code	Type	Price €	Unit/Box
450 0486	1 l		1/12





The ideal solution for industrial cooling and heating systems. Without an insulating panel, piping is fastened with clips positioned on a supporting metal mesh.

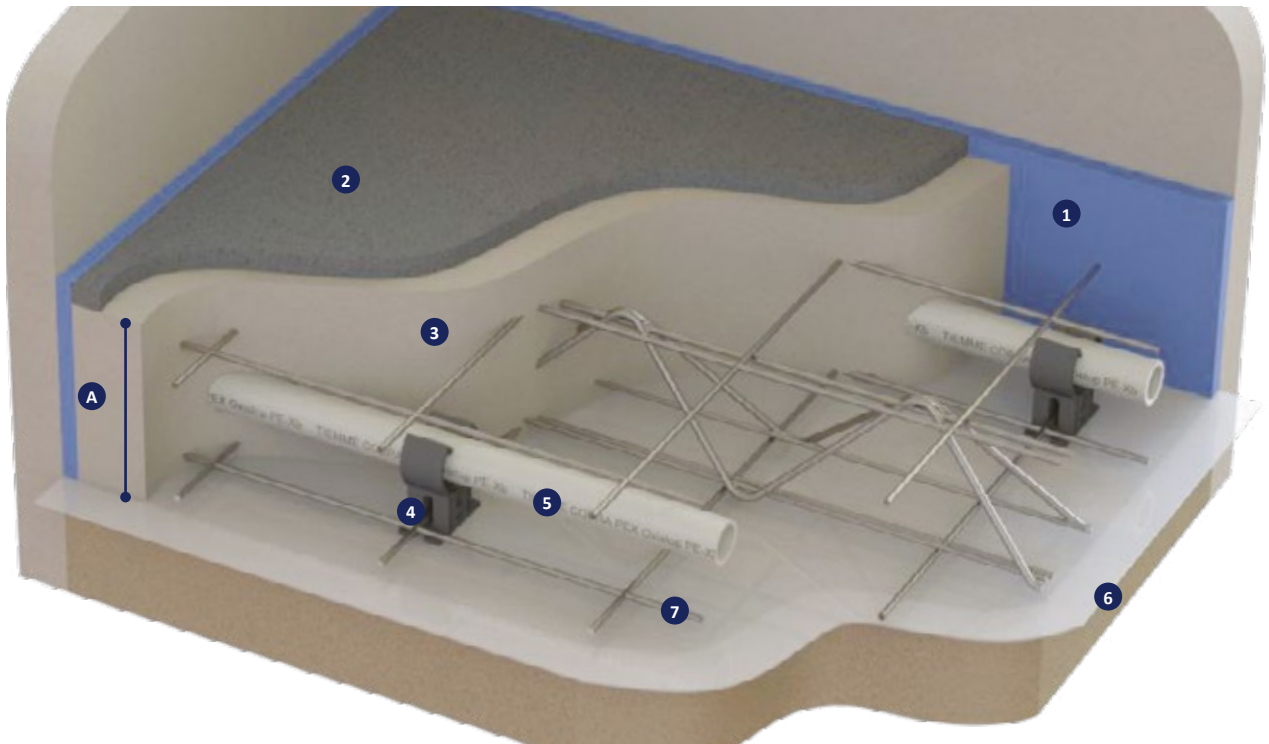

- |                        |           |
|------------------------|-----------|
| 1. Perimetral band     | art.4507  |
| 2. Industrial floor    | -         |
| 3. Screed              | -         |
| 4. Clip to fasten pipe | art.4525  |
| 5. Pipe                | art.0200B |
| 6. PE strip            | art.4503  |
| 7. Electro-welded mesh | art.4533  |

Code	Size (mm)
	A
-	150 ÷ 200



### 0200B

COBRAPEX cross-linked polyethylene high density pipe with EVOH anti-oxygen barrier.

#### TECHNICAL FEATURES

- Max operating temperature: 95 °C
- Thermal conductivity: 0,38 W/mk
- EN ISO 15875-2 compliant
- EVOH, DIN 4726 compliant anti-oxygen barrier
- Composition: PE-Xb

Code	Type	Price €/m	Unit/Box (m)
020 0011	20 x 2.0		120/2160
020 0012	20 x 2.0		300/2400
020 0004	20 x 2.0		500/2500
020 0009	25 x 2.3		300/1500



### 4507

Perimetral band in PE foam with adhesive back and mortar containment PE strip.

Code	Type	Price €/m	Unit/Box (m)
450 0030	H 250 x 8 mm		50/150



### 1480P

90° plastic elbow to protect and support COBRAPEX pipe near the connection to the distribution manifold.

Code	Type	Price €	Unit/Box
034 0078	pipe Ø20 - 22		25/100
034 0079	pipe Ø25		25/100



### 4525

Plastic gripper to be inserted manually, to fasten the pipe on the electro-welded mesh with a Ø 6 mm thread.

Code	Type	Price €	Unit/Box
450 0038	pipe Ø 20		200/200
450 0066	pipe Ø 25		200/2000

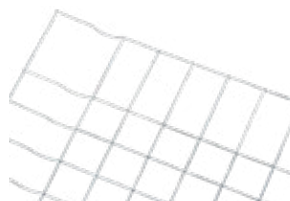

### 4533

Hot galvanized electro-welded mesh with Ø 6 mm thread and 100x100 mm mesh.

Code	Type	Price €/m <sup>2</sup>	Unit/Box (m <sup>2</sup> )
450 0043	2000 x 2000 mm		40/200



### 4540

Additive for screeds in water-based solution including acrylic polymers. It reduces hygroscopic receding and increases thermal resistance, thus improving thermal conductivity.

#### TECHNICAL FEATURES

- Dose: 1 kg additive x 100 Kg concrete

Code	Type	Price €/kg	Unit/Box (kg)
450 0019	10 Kg ≈ 9,6 l		10/10
450 0017	25 Kg ≈ 24 l		25/25

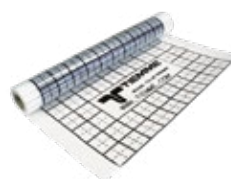

### 4503

PE moisture-proof insulating strip

#### TECHNICAL FEATURES

- Width: 1.2 m
- Length: 100 m
- Thickness: 0.15 mm

Code	Type	Price €/m <sup>2</sup>	Unit/Box (m <sup>2</sup> )
450 0025	-		120/120



### 4539

Protects against the corrosion of metal particles with universal bactericide and fungicide for heating and cooling systems.

#### TECHNICAL FEATURES

- Dose: 1 l additive x 100 l circulating water

Code	Type	Price €	Unit/Box
450 0486	1 l		1/12





**4520F**  
Gripper rod fastener.

Code	Type	Price €	Unit/Box
450 0034	-		1/1



**4535**  
System testing pump with 1/2" fitting.

Tank capacity: 8 l

Code	Type	Price €	Unit/Box
450 0049	50 bar		1/1



**4530**  
Pipe unloading system (until  $\varnothing 20$ )

Code	Type	Price €	Unit/Box
450 0028	-		1/1



**1495**  
Pipe cutting shear

Code	Type	Price €	Unit/Box
034 0015	0 - 35		1/5



**4522**  
Screed drier

Code	Type	Price €	Unit/Box
450 0020	230 Vac 2.5 KW		1/1



**4522A**  
230-380 Vac adapters for 4522

Code	Type	Price €	Unit/Box
450 0381	230 - 380 Vac		1/5



**1436N**  
Body adapter with 3/4"x18 fitting (EUROCONO) for PEX pipe

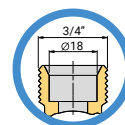

Code	Type	Price €	Unit/Box
144 0011	16 x 2.0 - 3/4"( $\varnothing 18$ )		10/250
144 0012	17 x 2.0 - 3/4"( $\varnothing 18$ )		10/200
144 0019	20 x 2.0 - 3/4"( $\varnothing 18$ )		10/200



**1636N**  
Body adapter with 3/4"x18 fitting (EUROCONO) for multilayer pipe

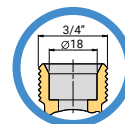

Code	Type	Price €	Unit/Box
144 0002	16 x 2.0 - 3/4"( $\varnothing 18$ )		10/250
144 0003	20 x 2.0 - 3/4"( $\varnothing 18$ )		10/200



**1436N06**  
1" fitting adapter for PE-X pipe

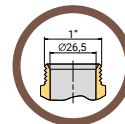

Code	Type	Price €	Unit/Box
144 0232	20 x 2.0 - 1" G		10/200
144 0075	25 x 2.3 - 1" G		10/200



**1879**  
End plug

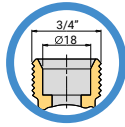

Code	Type	Price €	Unit/Box
144 0071	3/4" (ø18)		10/250









**0660S**  
Cross-linked polyethylene pipe  
with aluminum core, without  
box - White color

Code	Type	Aluminum	Price €/m	Unit/Box
060 0015	16 x 2.0	0.20		500 m/6000 m





# 04 DISTRIBUTION AND MIXING UNITS AND MANIFOLDS

## 04A Distribution manifolds for radiant systems

Couple of "FLOOR" manifolds in pressed brass with automatic deaerator and differential by-pass - 1"		104
Couple of "FLOOR" manifolds in pressed brass - 1"		107
Couple of "FLOOR" manifolds in pressed brass - 1"1/4		111
Couple of polyamide manifolds - 1"		115
Couple of polyamide manifolds - 1"1/4		117
Couple of "INDUSTRIAL FLOOR" manifolds in pressed brass - 1"1/2		119
Couple of manifolds in pressed brass for ceiling installation - 1"		122

## 04B Distribution and mixing units for radiant systems

Distribution and mixing units with fixed point control - 1"		123
Distribution and mixing units with climate control - 1"		127

## 04C Accessories for distribution and mixing units and manifolds



130

# 04A COUPLE OF "FLOOR" MANIFOLDS IN PRESSED BRASS WITH AUTOMATIC DEAREATOR AND DIFFERENTIAL BY-PASS - 1"

Tiemme distribution manifolds, art. 3873JBYD - 3873RBYDJ are the ideal solution for heating/cooling systems.

With automatic deaerator and differential by-pass, they expel air from the operating system, thus guaranteeing a correct management of the flow rate. Available with 1" fittings with clocked male/female thread, with 2÷14 ways with 3/4" (Ø18) Eurocone fittings with or without insulation shell.

The manifolds include shut-off valves with thermometer support and loading/unloading cock/s. The inlet flow rate of each way can be controlled with a flow meter.

Manual thermostatic shut-off valves on the return manifold are provided with a protective head that can be easily replace with a 9567 thermoelectric controller.

## DIFFERENTIAL BY-PASS

Distribution circuits in radiant systems can be intercepted by means of electro-thermal controllers. The gradual reduction of the flow rate due to the partial or total closure of circuits, results in an increase of the differential pressure that can entail noise, temperature unevenness, high fluid speed and system hydraulic unbalance.

The differential by-pass kit included in Tiemme manifold, art. 3873JBYD - 3873RBYDJ, allows to maintain the pressure balance in the entire system. In the by-pass there is a check valve consisting of a preset 15 kPa spring that cannot be modified.

Once the spring reaches the preset pressure value, the valve opens gradually and automatically. This triggers the fluid to circulate in the by-pass, whose flow rate is proportionate to the gradual closure of electro-thermal controllers, thus enabling a constant differential pressure within the system. Thanks to its compact size, the differential by-pass introduced in manifolds for radiant systems does not require any modification to the manifold size and can be used with existing and operational manifolds.

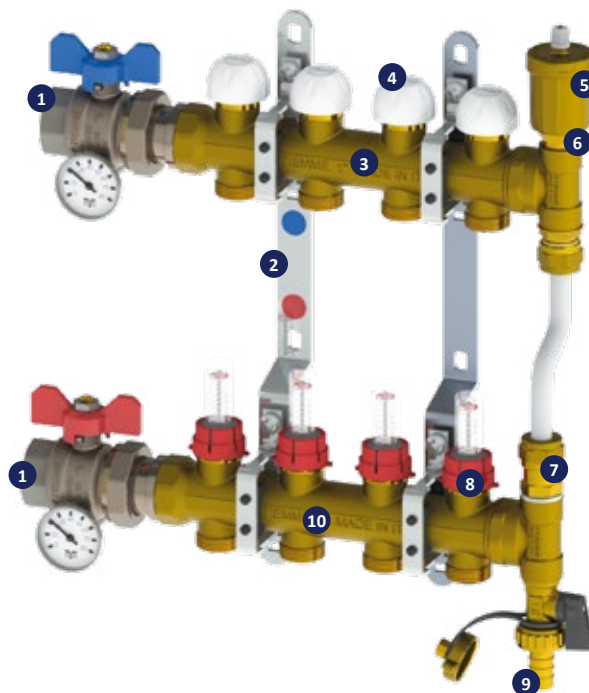
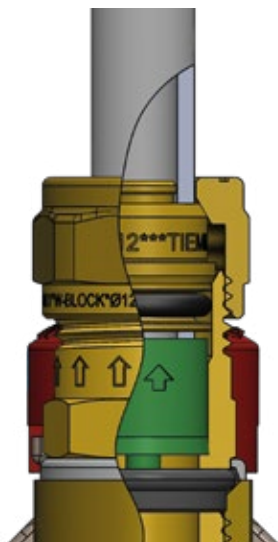

1. Full passage shut-off ball valve with thermometer
2. Fixing brackets
3. Return manifold
4. Manual thermostatic shut-off valves with protective head
5. Automatic deaerator
6. Check valve
7. 15 kPa differential by-pass
8. Flow meters
9. Charging and relief valve
10. Inflow manifold

## TECHNICAL SPECIFICATIONS

- Differential by-pass: 15kPa
- Max operating temperature: 110 °C
- Min operating temperature: -20 °C
- Max operating pressure: 10 bar
- Supported fluids: water (with glycol < 50%)
- Manifold threads: Male/Female ISO 228
- Outlet fittings: 3/4" (Ø18) (Eurocone)
- Brass detail material: Brass CW617N
- Gasket material: ethylene-propylene rubber (EPDM)
- Bracket material: galvanized steel



# 04A COUPLE OF "FLOOR" MANIFOLDS IN PRESSED BRASS WITH AUTOMATIC DEAREATOR AND DIFFERENTIAL BY-PASS - 1"



## 3873JBYD

1" distribution manifold with differential by-pass and flow meters

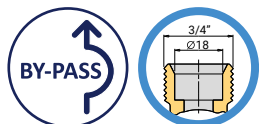

**i** Can be combined with box, art. 1939

Code	Type	Ways	Price €	Pack
385 0255	1"G	2		1/1
385 0256	1"G	3		1/1
385 0257	1"G	4		1/1
385 0258	1"G	5		1/1
385 0259	1"G	6		1/1
385 0260	1"G	7		1/1
385 0261	1"G	8		1/1
385 0262	1"G	9		1/1
385 0263	1"G	10		1/1
385 0264	1"G	11		1/1
385 0265	1"G	12		1/1
385 0268	1"G	13		1/1
385 0269	1"G	14		1/1

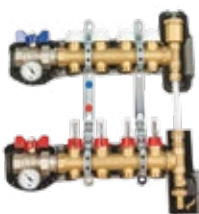

## 3873RBYDJ

1" insulated distribution manifold with differential by-pass and flow meters



**i** Can be combined with box, art. 1940

Code	Type	Ways	Price €	Unit/Box
557 0653	1"G	2		1/1
557 0654	1"G	3		1/1
557 0655	1"G	4		1/1
557 0656	1"G	5		1/1
557 0657	1"G	6		1/1
557 0658	1"G	7		1/1
557 0659	1"G	8		1/1
557 0660	1"G	9		1/1
557 0661	1"G	10		1/1
557 0662	1"G	11		1/1
557 0663	1"G	12		1/1
557 0670	1"G	13		1/1
557 0671	1"G	14		1/1

## ACCESSORIES AND SPARE PARTS



## 3051ISOL

1" manifold insulation shell

Code	Type	Price €	Unit/Box
557 0121	1"		1/6



## 1890JISOL

1" end unit insulation shell and automatic air vent valve

Code	Type	Price €	Unit/Box
557 0668	1"		1/12



## 2121PTISOL

Insulation shell for 1" ball valve with thermometer support

Code	Type	Price €	Unit/Box
557 0119	1"		1/12

## DIMENSIONS

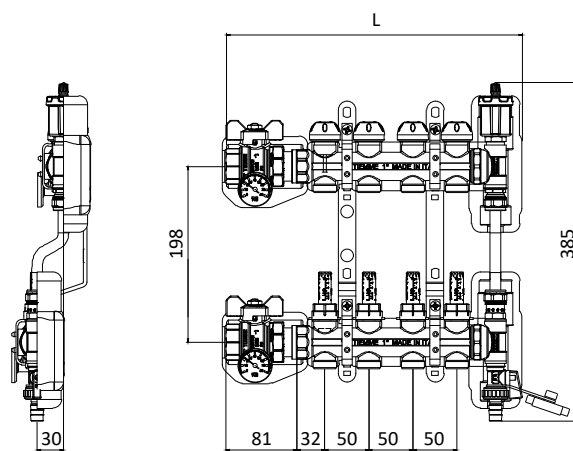

**i** For the full range of accessories and spare parts, see page 130

# 04A COUPLE OF "FLOOR" MANIFOLDS IN PRESSED BRASS WITH AUTOMATIC DEAREATOR AND DIFFERENTIAL BY-PASS - 1"



**1939**  
Box for manifolds with adjustable height and depth

**i** 90 mm to 140 mm adjustable depth

Code	Type	Price €	Unit/Box
181 0192	400 x 660 x 90 ÷ 140		1/1
181 0193	500 x 660 x 90 ÷ 140		1/1
181 0206	600 x 660 x 90 ÷ 140		1/1
181 0194	700 x 660 x 90 ÷ 140		1/1
181 0195	1000 x 660 x 90 ÷ 140		1/1

## 1939 DIMENSIONS

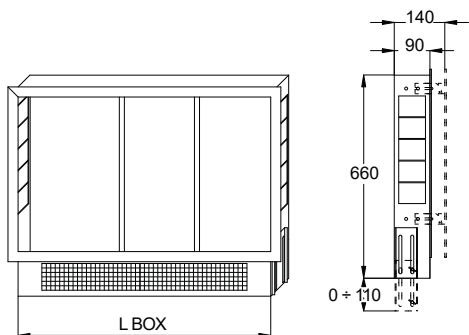

### GUIDE TO BOX SELECTION

MANIFOLD COMPATIBILITY: 3873JBYD

No. ways	L* (mm)	L BOX (mm)	Code
2	232	400	181 0192
3	282		
4.	332		
5	382	500	181 0193
6	432		
7	482	600	181 0206
8	532		
9	582	700	181 0194
10	632		
11	682	1000	181 0195
12	732		
13	782		
14	832		

\* Manifold width



**1940**  
Box for distribution and mixing units and manifolds with adjustable height and depth

**i** 120 mm to 170 mm adjustable depth

Code	Type	Price €	Unit/Box
181 0020	600 x 670 x 120 ÷ 170		1/1
181 0016	700 x 670 x 120 ÷ 170		1/1
181 0015	850 x 670 x 120 ÷ 170		1/1
181 0019	1000 x 670 x 120 ÷ 170		1/1

## 1940 DIMENSIONS

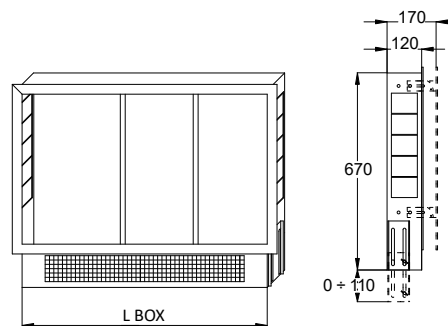

### GUIDE TO BOX SELECTION

MANIFOLD COMPATIBILITY: 3873RBYDJ

No. ways	L* (mm)	L BOX (mm)	Code
2	262	600	181 0020
3	312		
4.	362		
5	412		
6	462	700	181 0016
7	512		
8	562		
9	612	850	181 0015
10	662		
11	712		
12	762		
13	812	1000	181 0019
14	862		

\* Manifold width





# 04<sub>A</sub> COUPLE OF "FLOOR" MANIFOLDS IN PRESSED BRASS - 1"

Tiemme distribution manifolds, art. 3873JBYD - 3873RBYDJ are the ideal solution for heating/cooling systems. Available with 1" fittings with clocked male/female thread and 2÷14 ways with 3/4" (Ø18) Eurocone fittings.

The manifolds include shut-off valves with thermometer support, air vent valve/s, and loading and unloading cock/s. Tiemme distribution manifolds can be provided with by-pass (art. 3873BY-3878BY), without by-pass (art. 3873-3878) or with insulation shell (art. 3873R-3873RBY).

The inlet flow rate of each way can be controlled with a flow meter (art. 3873) or with a mechanical memory screw (art. 3878).

Manual thermostatic shut-off valves on the return manifold are provided with a protective head that can be easily replaced with a 9567 thermoelectric controller.

## TECHNICAL SPECIFICATIONS

- Max operating temperature: 110 °C
- Min operating temperature: -20 °C
- Max operating pressure: 10 bar
- Supported fluids: water (with glycol < 50%)
- Manifold threads: Male/Female ISO 228
- Outlet fittings: 3/4" (Ø18) Eurocone
- Brass detail material: Brass CW617N
- Gasket material: EPDM
- Bracket material: galvanized steel

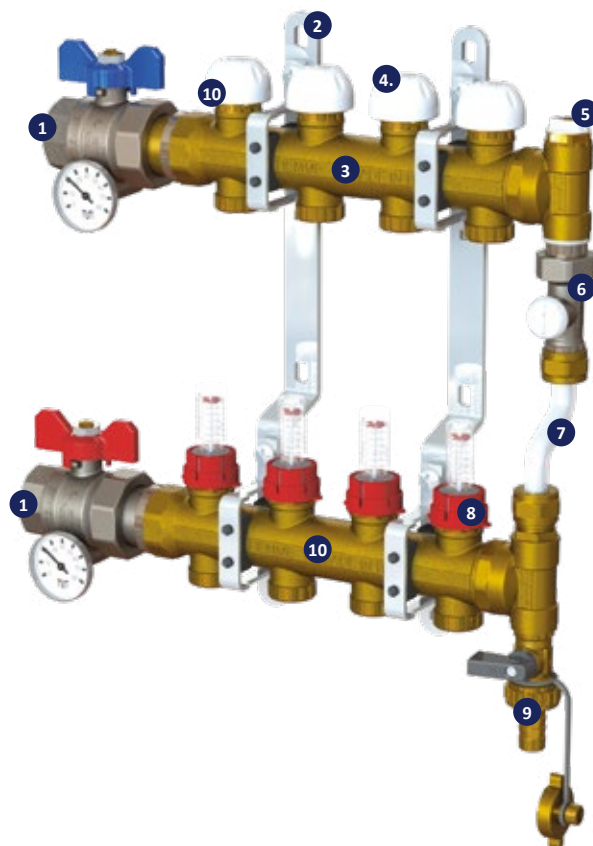

1. Full passage shut-off ball valve with thermometer
2. Fixing brackets
3. Return manifold
4. Manual thermostatic shut-off valves with protective head
5. Manual bleeding valve
6. By-pass lockshield
7. By-pass
8. Flow meters or mechanical memory screws.
9. Charging and relief valve
10. Inflow manifold

# 04A COUPLE OF "FLOOR" MANIFOLDS IN PRESSED BRASS - 1"



**3873**  
1" distribution manifold with flow meters

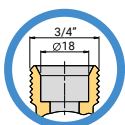

**i** Can be combined with box, art. 1939

Code	Type	Ways	Price €	Unit/Box
385 0045	1"G	2		1/1
385 0029	1"G	3		1/1
385 0020	1"G	4		1/1
385 0011	1"G	5		1/1
385 0010	1"G	6		1/1
385 0009	1"G	7		1/1
385 0002	1"G	8		1/1
385 0014	1"G	9		1/1
385 0036	1"G	10		1/1
385 0041	1"G	11		1/1
385 0022	1"G	12		1/1
385 0118	1"G	13		1/1
385 0119	1"G	14		1/1

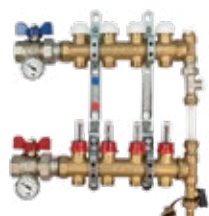

**3873BY**  
1" distribution manifold with by-pass and flow meters



**i** Can be combined with box, art. 1939

Code	Type	Ways	Price €	Unit/Box
385 0062	1"G	2		1/1
385 0061	1"G	3		1/1
385 0043	1"G	4		1/1
385 0026	1"G	5		1/1
385 0001	1"G	6		1/1
385 0004	1"G	7		1/1
385 0008	1"G	8		1/1
385 0013	1"G	9		1/1
385 0006	1"G	10		1/1
385 0021	1"G	11		1/1
385 0007	1"G	12		1/1
385 0120	1"G	13		1/1
385 0121	1"G	14		1/1



**3878**  
1" distribution manifold with mechanical memory screws

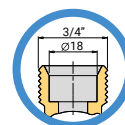

**i** Can be combined with box, art. 1939

Code	Type	Ways	Price €	Unit/Box
385 0040	1"G	2		1/1
385 0042	1"G	3		1/1
385 0035	1"G	4		1/1
385 0030	1"G	5		1/1
385 0028	1"G	6		1/1
385 0044	1"G	7		1/1
385 0031	1"G	8		1/1
385 0065	1"G	9		1/1
385 0058	1"G	10		1/1
385 0057	1"G	11		1/1
385 0060	1"G	12		1/1

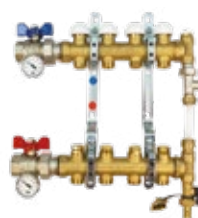

**3878BY**  
1" distribution manifold with by-pass and mechanical memory screws



**i** Can be combined with box, art. 1939

Code	Type	Ways	Price €	Unit/Box
385 0068	1"G	2		1/1
385 0069	1"G	3		1/1
385 0067	1"G	4		1/1
385 0064	1"G	5		1/1
385 0052	1"G	6		1/1
385 0066	1"G	7		1/1
385 0033	1"G	8		1/1
385 0055	1"G	9		1/1
385 0051	1"G	10		1/1
385 0050	1"G	11		1/1
385 0056	1"G	12		1/1



# 04A COUPLE OF "FLOOR" MANIFOLDS IN PRESSED BRASS - 1"



**3873R**  
1" insulated distribution manifold with flow meters

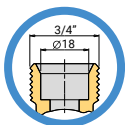

**i** Can be combined with box, art. 1940

Code	Type	Ways	Price €	Unit/Box
557 0029	1"G	2		1/1
557 0030	1"G	3		1/1
557 0031	1"G	4		1/1
557 0032	1"G	5		1/1
557 0033	1"G	6		1/1
557 0034	1"G	7		1/1
557 0035	1"G	8		1/1
557 0036	1"G	9		1/1
557 0037	1"G	10		1/1
557 0038	1"G	11		1/1
557 0039	1"G	12		1/1
557 0672	1"G	13		1/1
557 0673	1"G	14		1/1

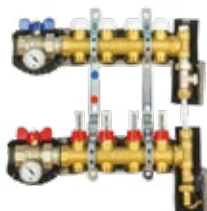

**3873RBY**  
1" insulated distribution manifold with by-pass and flow meters



**i** Can be combined with box, art. 1940

Code	Type	Ways	Price €	Unit/Box
557 0040	1"G	2		1/1
557 0041	1"G	3		1/1
557 0042	1"G	4		1/1
557 0043	1"G	5		1/1
557 0044	1"G	6		1/1
557 0045	1"G	7		1/1
557 0046	1"G	8		1/1
557 0047	1"G	9		1/1
557 0048	1"G	10		1/1
557 0049	1"G	11		1/1
557 0050	1"G	12		1/1
557 0674	1"G	13		1/1
557 0675	1"G	14		1/1

## ACCESSORIES AND SPARE PARTS



**3051ISOL**  
1" manifold insulation shell

Code	Type	Price €	Unit/Box
557 0121	1"		1/6



**1890ISOL**  
1" end unit insulation shell and air vent valve

Code	Type	Price €	Unit/Box
557 0117	1"		1/12



**2121PTISOL**  
Insulation shell for 1" ball valve with thermometer support

Code	Type	Price €	Unit/Box
557 0119	1"		1/12

## DIMENSIONS

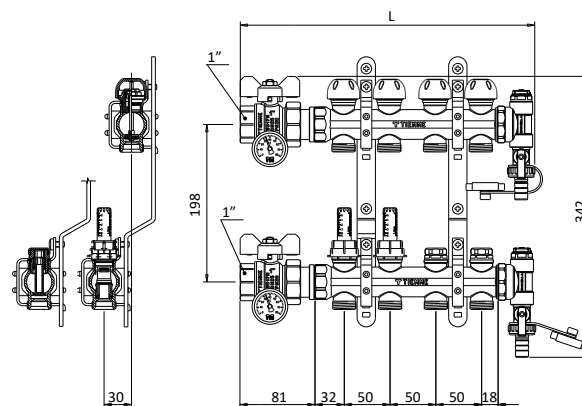

**i** For the full range of accessories and spare parts, see page 130

# 04A COUPLE OF "FLOOR" MANIFOLDS IN PRESSED BRASS - 1"



## 1939

Box for manifolds with adjustable height and depth

**i** 90 mm to 140 mm adjustable depth

Code	Type	Price €	Unit/Box
181 0192	400 x 660 x 90 ÷ 140		1/1
181 0193	500 x 660 x 90 ÷ 140		1/1
181 0206	600 x 660 x 90 ÷ 140		1/1
181 0194	700 x 660 x 90 ÷ 140		1/1
181 0195	1000 x 660 x 90 ÷ 140		1/1

### 1939 DIMENSIONS

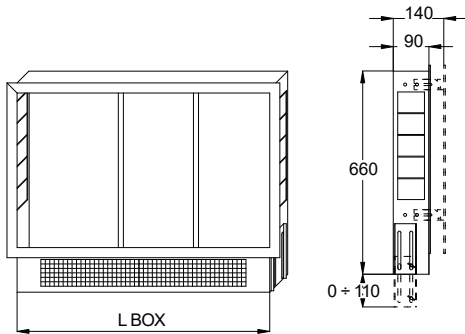

#### GUIDE TO BOX SELECTION

MANIFOLD COMPATIBILITY: 3873 - 3873BY - 3878 - 3878BY

No. ways	L* (mm)	L BOX (mm)	Code
2	232	400	181 0192
3	282		
4	332		
5	382	500	181 0193
6	432		
7	482	600	181 0206
8	532		
9	582	700	181 0194
10	632		
11	682	1000	181 0195
12	732		
13	782		
14	832		

\* Manifold width



## 1940

Box for distribution and mixing units and manifolds with adjustable height and depth

**i** 120 mm to 170 mm adjustable depth

Code	Type	Price €	Unit/Box
181 0020	600 x 670 x 120 ÷ 170		1/1
181 0016	700 x 670 x 120 ÷ 170		1/1
181 0015	850 x 670 x 120 ÷ 170		1/1
181 0019	1000 x 670 x 120 ÷ 170		1/1

### 1940 DIMENSIONS

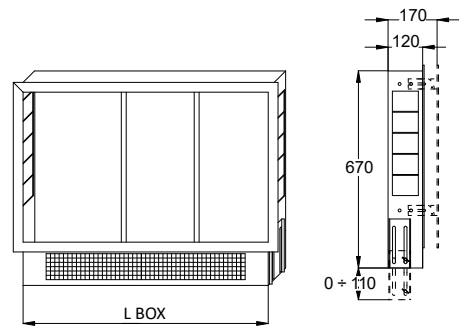

#### GUIDE TO BOX SELECTION

MANIFOLD COMPATIBILITY: 3873R - 3873RBY

No. ways	L* (mm)	L BOX (mm)	Code
2	262	600	181 0020
3	312		
4	362		
5	412		
6	462	700	181 0016
7	512		
8	562	850	181 0015
9	612		
10	662	1000	181 0019
11	712		
12	762		
13	812		
14	862		

\* Manifold width



Tiemme distribution manifolds, art. 3877 - 3879 are the ideal solution for heating and/or cooling systems.

Available with 1"1/4 fittings with clocked male/female thread and 2÷12 ways with 3/4" (Ø18) Eurocone fittings. The manifolds include shut-off valves, air vent valve/s, and loading and unloading cock/s.

Tiemme distribution manifolds can be provided with by-pass (art. 3877BY), without by-pass (art. 3873-3877) or with insulation shell (art. 3873R-3873RBY). The inlet flow rate of each way can be controlled with a flow meter (art. 3877) or with a mechanical memory screw (art. 3879).

Manual thermostatic shut-off valves on the return manifold are provided with a protective head that can be easily replaced with a 9567 thermoelectric controller.

## TECHNICAL SPECIFICATIONS

- Max operating temperature: 110 °C
- Min operating temperature: -20 °C
- Max operating pressure: 10 bar
- Supported fluids: water (with glycol < 50%)
- Manifold threads: Male/Female ISO 228
- Outlet fittings: 3/4" (Ø18) (Eurocone)
- Brass detail material: Brass CW617N
- Gasket material: EPDM
- Bracket material: galvanized steel

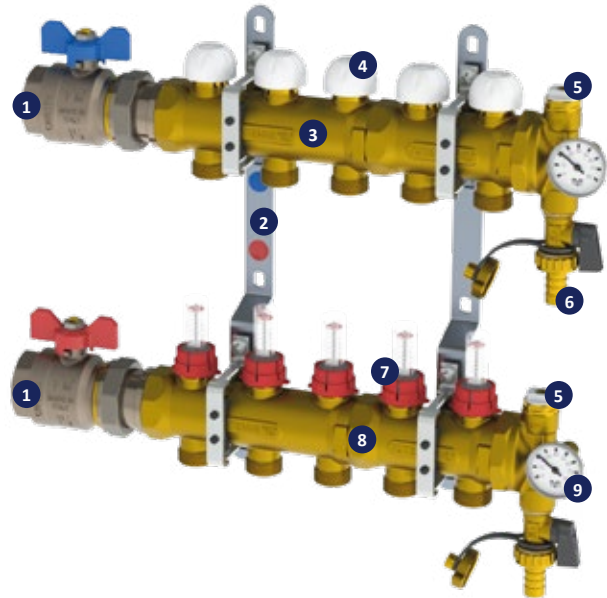

1. Full passage shut-off ball valve
2. Fixing brackets
3. Return manifold
4. Manual thermostatic shut-off valves with protective head
5. Manual bleeding valve
6. Charging and relief valve
7. Flow meters or mechanical memory screws.
8. Inflow manifold
9. Thermometer

# 04A COUPLE OF "FLOOR" MANIFOLDS IN PRESSED BRASS - 1"1/4



**3877**  
1"1/4 distribution manifold  
with flow meters

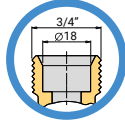

Code	Type	Ways	Price €	Unit/Box
385 0122	1" 1/4G	2		1/1
385 0123	1" 1/4G	3		1/1
385 0124	1" 1/4G	4		1/1
385 0125	1" 1/4G	5		1/1
385 0126	1" 1/4G	6		1/1
385 0127	1" 1/4G	7		1/1
385 0128	1" 1/4G	8		1/1
385 0129	1" 1/4G	9		1/1
385 0130	1" 1/4G	10		1/1
385 0131	1" 1/4G	11		1/1
385 0132	1" 1/4G	12		1/1



**3879**  
1"1/4 distribution manifold  
with mechanical memory  
screws

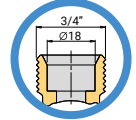

Code	Type	Ways	Price €	Unit/Box
385 0144	1" 1/4G	2		1/1
385 0145	1" 1/4G	3		1/1
385 0146	1" 1/4G	4		1/1
385 0147	1" 1/4G	5		1/1
385 0148	1" 1/4G	6		1/1
385 0149	1" 1/4G	7		1/1
385 0150	1" 1/4G	8		1/1
385 0151	1" 1/4G	9		1/1
385 0152	1" 1/4G	10		1/1
385 0153	1" 1/4G	11		1/1
385 0154	1" 1/4G	12		1/1



**3877BY**  
1"1/4 distribution manifold  
with by-pass and flow meters

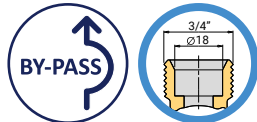

Code	Type	Ways	Price €	Unit/Box
385 0133	1" 1/4G	2		1/1
385 0134	1" 1/4G	3		1/1
385 0135	1" 1/4G	4		1/1
385 0136	1" 1/4G	5		1/1
385 0137	1" 1/4G	6		1/1
385 0138	1" 1/4G	7		1/1
385 0139	1" 1/4G	8		1/1
385 0140	1" 1/4G	9		1/1
385 0141	1" 1/4G	10		1/1
385 0142	1" 1/4G	11		1/1
385 0143	1" 1/4G	12		1/1



**3879BY**  
1"1/4 distribution manifold  
with by-pass and mechanical  
memory screws

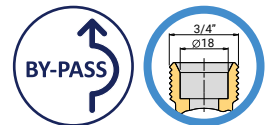

Code	Type	Ways	Price €	Unit/Box
385 0155	1" 1/4G	2		1/1
385 0156	1" 1/4G	3		1/1
385 0157	1" 1/4G	4		1/1
385 0158	1" 1/4G	5		1/1
385 0159	1" 1/4G	6		1/1
385 0160	1" 1/4G	7		1/1
385 0161	1" 1/4G	8		1/1
385 0162	1" 1/4G	9		1/1
385 0163	1" 1/4G	10		1/1
385 0164	1" 1/4G	11		1/1
385 0165	1" 1/4G	12		1/1



# 04A COUPLE OF "FLOOR" MANIFOLDS IN PRESSED BRASS - 1"1/4

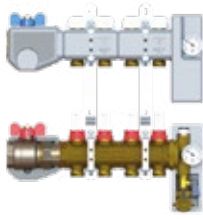

**3877R**  
1"1/4 insulated distribution manifold with flow meters

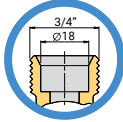

Code	Type	Ways	Price €	Unit/Box
557 0571	1" 1/4G	2		1/1
557 0572	1" 1/4G	3		1/1
557 0573	1" 1/4G	4		1/1
557 0574	1" 1/4G	5		1/1
557 0575	1" 1/4G	6		1/1
557 0576	1" 1/4G	7		1/1
557 0577	1" 1/4G	8		1/1
557 0578	1" 1/4G	9		1/1
557 0579	1" 1/4G	10		1/1
557 0580	1" 1/4G	11		1/1
557 0581	1" 1/4G	12		1/1

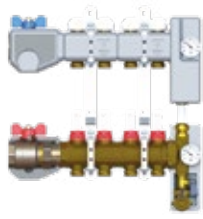

**3877RBY**  
1"1/4 insulated distribution manifold with by-pass and flow meters

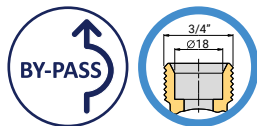

Code	Type	Ways	Price €	Unit/Box
557 0582	1" 1/4G	2		1/1
557 0583	1" 1/4G	3		1/1
557 0584	1" 1/4G	4		1/1
557 0585	1" 1/4G	5		1/1
557 0586	1" 1/4G	6		1/1
557 0587	1" 1/4G	7		1/1
557 0588	1" 1/4G	8		1/1
557 0589	1" 1/4G	9		1/1
557 0590	1" 1/4G	10		1/1
557 0591	1" 1/4G	11		1/1
557 0592	1" 1/4G	12		1/1

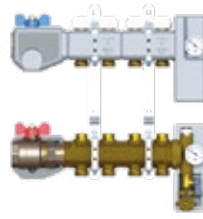

**3879R**  
1"1/4 insulated distribution manifold with mechanical memory screws

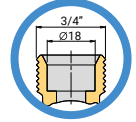

Code	Type	Ways	Price €	Unit/Box
557 0561	1" 1/4G	2		1/1
557 0562	1" 1/4G	3		1/1
557 0563	1" 1/4G	4		1/1
557 0564	1" 1/4G	5		1/1
557 0565	1" 1/4G	6		1/1

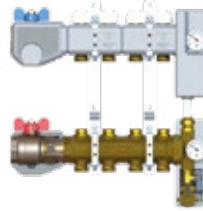

**3879RBY**  
1"1/4 insulated distribution manifold with by-pass and mechanical memory screws

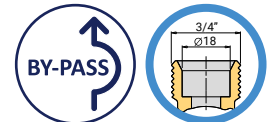

Code	Type	Ways	Price €	Unit/Box
557 0566	1" 1/4G	2		1/1
557 0567	1" 1/4G	3		1/1
557 0568	1" 1/4G	4		1/1
557 0569	1" 1/4G	5		1/1
557 0570	1" 1/4G	6		1/1

# 04A COUPLE OF "FLOOR" MANIFOLDS IN PRESSED BRASS - 1"1/4

## ACCESSORIES



**3051ISOL**  
1"1/4 manifold insulation shell

Code	Type	Price €	Unit/Box
557 0122	1"1/4		1/5



**1890ISOL**  
1"1/4 - 1"1/2 end unit insulation shell and air vent valve

Code	Type	Price €	Unit/Box
557 0516	1"1/4 - 1"1/2		1/10



**2121PTISOL**  
Insulation shell for 1"1/4 ball valve with thermometer support

Code	Type	Price €	Unit/Box
557 0120	1"1/4		1/10

## DIMENSIONS

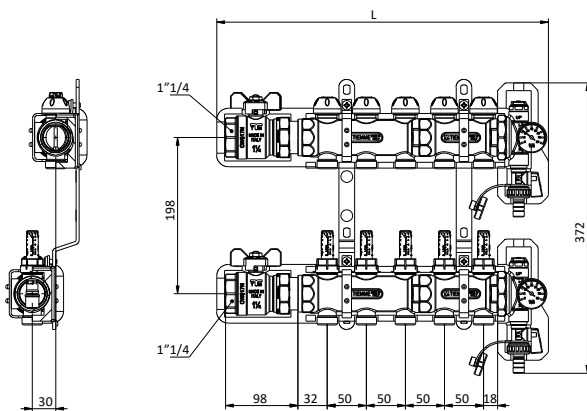

**1940**  
Box for distribution and mixing units and manifolds with adjustable height and depth

**i** 120 mm to 170 mm adjustable depth

Code	Type	Price €	Unit/Box
181 0020	600 x 670 x 120 ÷ 170		1/1
181 0016	700 x 670 x 120 ÷ 170		1/1
181 0015	850 x 670 x 120 ÷ 170		1/1
181 0019	1000 x 670 x 120 ÷ 170		1/1

## 1940 DIMENSIONS

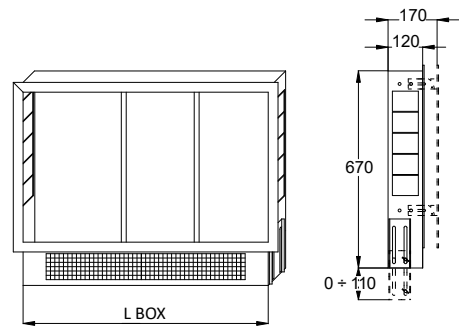

### GUIDE TO BOX SELECTION

MANIFOLD COMPATIBILITY: 3877 - 3877BY - 3879 - 3879BY - 3877R - 3877RBY - 3879R - 3879RBY

No. ways	L* (mm)	L BOX (mm)	Code
2	262	600	181 0020
3	312		
4	362		
5	412		
6	462		
7	512	700	181 0016
8	562		
9	612		
10	662	850	181 0015
11	712		
12	762		

\* Manifold width

**i** For the full range of accessories and spare parts, see page 130





# 04A COUPLE OF POLYAMIDE MANIFOLDS - 1"

The 3871POL distribution manifold is designed in high-tech thermoplastic material, for radiant heating and cooling systems with double anti-condensation chamber.

These patented modular manifolds include flow meters with a graduated scale and possible total closure of the inflow module way.

Each return module includes a thermostatic insert to apply an electro-thermal actuator.

3/4" x 18 Eurocone outlets support both PEX and multilayer piping.

Low pressure drop (due to inflow and return module shape) allow to use pipes feeding small diameter heating circuits.

These TECHNICAL SPECIFICATIONS are possible thanks to high-tech thermoplastic materials. Specifically, modules are made in a reinforced polyamide with 50% fiberglass, whose characteristics are similar to those of light alloys but shows a significantly higher weather resistance. Another essential manifold's feature is absolute resistance to calcium sediments and protection against any kind of corrosion.

## TECHNICAL SPECIFICATIONS

- Max glycol percentage: 50%
- Operating pressure: 1.5 ÷ 2.5 bar
- Maximum operating pressure: 6 bar
- Temperature range: 4 °C ÷ 70 °C

### INFLOW MODULE COMPOSITION:

- Body: PAS777
- Shutter: PES
- Flow rate index: POM
- Cap: CW614N
- Handle: ABS
- Cap covering: ABS
- O-ring: NBR

### RETURN MODULE COMPOSITION:

- Body: PAS777
- Thermostatic block: CW614N
- Stick: AISI303
- Spring: AISI302
- Handle: ABS
- O-ring: NBR

### HEAD/END KIT COMPOSITION:

- Air discharge body/end: PAS777
- Bracket/collar: steel
- Screws: C15
- Threaded bar: CR3 galvanized Fe37
- Brass components: CW617N

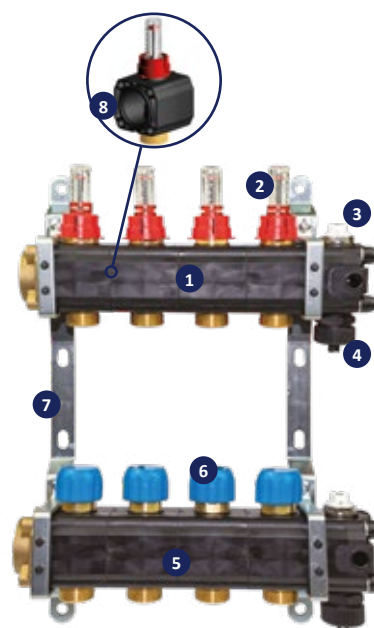

1. Inflow manifold
2. Flow meters
3. Manual bleeding valve
4. Charging and relief valve
5. Return manifold
6. Manual thermostatic shut-off valves with protective head
7. Fixing brackets
8. Double chamber

## PRODUCT RANGE



### 3871POL

1" polyamide distribution manifold with double chamber and flow meters

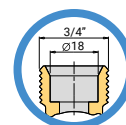

Code	Type	Ways	Price €	Unit/Box
388 0020	1"G	2		1/1
388 0021	1"G	3		1/1
388 0022	1"G	4		1/1
388 0023	1"G	5		1/1
388 0024	1"G	6		1/1
388 0025	1"G	7		1/1
388 0026	1"G	8		1/1
388 0027	1"G	9		1/1
388 0028	1"G	10		1/1
388 0029	1"G	11		1/1
388 0030	1"G	12		1/1
388 0053	1"G	13		1/1
388 0054	1"G	14		1/1

## ACCESSORIES



**2120R**  
Straight valve with reversible thermometer fitting

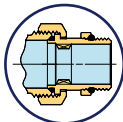

PATENTED

Code	Type	Price €	Unit/Box
	<b>red handle</b>		
212 0043	1"		5/20
	<b>blue handle</b>		
212 0042	1"		5/20



**2121PTISOL**  
Insulation shell for 1" ball valve with thermometer support

Code	Type	Price €	Unit/Box
557 0119	1"		1/12

## DIMENSIONS

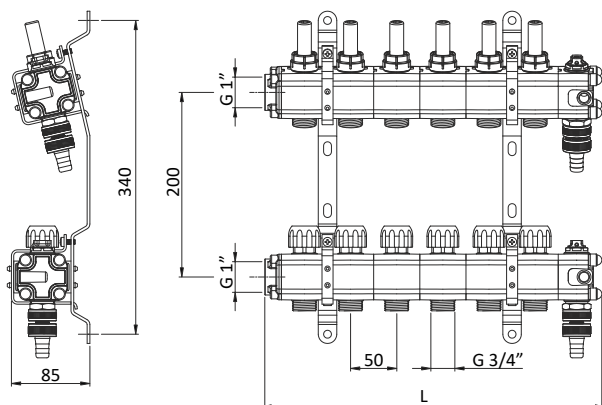

**1939**  
Box for manifolds with adjustable height and depth

90 mm to 140 mm adjustable depth

Code	Type	Price €	Unit/Box
181 0192	400 x 660 x 90 ÷ 140		1/1
181 0193	500 x 660 x 90 ÷ 140		1/1
181 0206	600 x 660 x 90 ÷ 140		1/1
181 0194	700 x 660 x 90 ÷ 140		1/1
181 0195	1000 x 660 x 90 ÷ 140		1/1

## 1939 DIMENSIONS

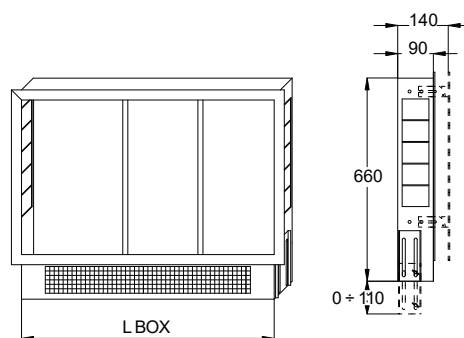

### GUIDE TO BOX SELECTION

MANIFOLD COMPATIBILITY: 3871POL

No. ways	L' (mm)	L' + valve (mm)	L BOX (mm)	Code
2	165	246	400	181 0192
3	215	296		
4	265	346	500	181 0193
5	315	396		
6	365	446	600	181 0206
7	415	496		
8	465	546	700	181 0194
9	515	596		
10	565	646	1000	181 0195
11	615	696		
12	665	746		
13	715	796		
14	765	846		

In order to determine the manifold/box match, the size of accessory ball valve has been taken into account.

\* Manifold width

For the full range of accessories and spare parts, see page 130



# 04A COUPLE OF POLYAMIDE MANIFOLDS - 1"1/4

The 3872POL distribution manifolds are designed in high-tech thermoplastic material, for radiant heating and cooling systems.

These patented modular manifolds include flow meters with a graduated scale and possible total closure of the inflow module way.

Each return module includes a thermostatic insert to apply an electro-thermal actuator. 3/4" x 18 Eurocone outlets support both PEX and multilayer piping.

Low pressure drop (due to inflow and return module shape) allow to use pipes feeding small diameter heating circuits.

These TECHNICAL SPECIFICATIONS are possible thanks to high-tech thermoplastic materials. Specifically, modules are made in a reinforced polyamide with 50% fiberglass, whose characteristics are similar to those of light alloys but shows a significantly higher weather resistance.

Another essential manifold's feature is absolute resistance to calcium sediments and protection against any kind of corrosion.

## TECHNICAL SPECIFICATIONS

- Max glycol percentage: 50%
- Operating pressure: 1,5 ÷ 2,5 bar
- Maximum operating pressure: 6 bar
- Testing pressure: 8 bar
- Temperature range: 4 °C ÷ 70 °C

### INFLOW MODULE COMPOSITION:

- Body: PAS777
- Shutter: PES
- Flow rate index: POM
- Cap: CW614N
- Handle: ABS
- Cap covering: ABS
- O-ring: NBR

### RETURN MODULE COMPOSITION:

- Body: PAS777
- Thermostatic block: CW614N
- Stick: AISI303
- Spring: AISI302
- Handle: ABS
- O-ring: NBR

### HEAD/END KIT COMPOSITION:

- Air discharge body/end: PAS777
- Bracket/collar: PP
- Screws: C15
- Threaded bar: CR3 galvanized Fe37
- Brass components: CW617N
- Unloading cock: PA6
- O-rings: NBR70

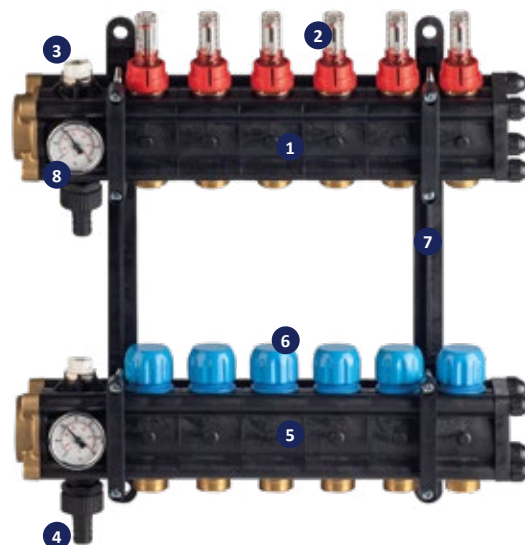

1. Inflow manifold
2. Flow meters
3. Manual bleeding valve
4. Charging and relief valve
5. Return manifold
6. Manual thermostatic shut-off valves with protective head
7. Fixing brackets
8. Thermometer

## PRODUCT RANGE

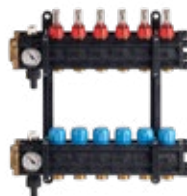

### 3872POL

1"1/4 polyamide distribution manifold with flow meters

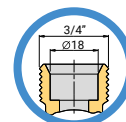

**i** To be used with 9568 controller.

Code	Type	Ways	Price €	Unit/Box
388 0007	1" 1/4G	2		1/1
388 0008	1" 1/4G	3		1/1
388 0009	1" 1/4G	4		1/1
388 0003	1" 1/4G	5		1/1
388 0004	1" 1/4G	6		1/1
388 0010	1" 1/4G	7		1/1
388 0011	1" 1/4G	8		1/1
388 0012	1" 1/4G	9		1/1
388 0005	1" 1/4G	10		1/1
388 0006	1" 1/4G	11		1/1
388 0001	1" 1/4G	12		1/1
388 0002	1" 1/4G	13		1/1
388 0013	1" 1/4G	14		1/1
388 0014	1" 1/4G	15		1/1
388 0015	1" 1/4G	16		1/1

## ACCESSORIES



**2371**  
MISTRAL male/female ISO 228 ball valve with T handle

Code	Type	Price €	Unit/Box
 <b>red handle</b>			
236 0031	1"1/4		8/32
 <b>blue handle</b>			
236 0138	1"1/4		8/32



**2371ISOL**  
1"1/4 insulation shell for MISTRAL male-female ball valve

Code	Type	Price €	Unit/Box
557 0528	1"1/4		1/10

## DIMENSIONS

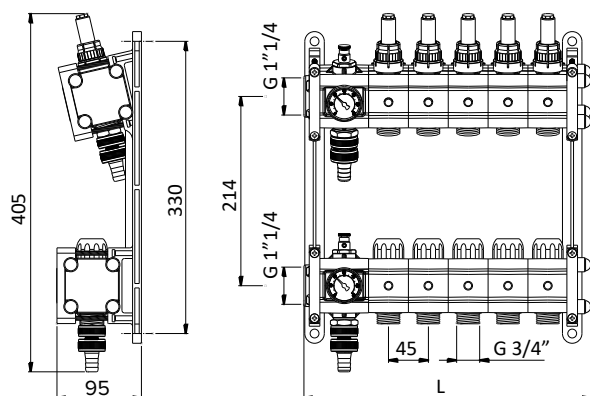

**1940**  
Box for distribution and mixing units and manifolds with adjustable height and depth

 120 mm to 170 mm adjustable depth

Code	Type	Price €	Unit/Box
181 0020	600 x 670 x 120 ÷ 170		1/1
181 0016	700 x 670 x 120 ÷ 170		1/1
181 0015	850 x 670 x 120 ÷ 170		1/1
181 0019	1000 x 670 x 120 ÷ 170		1/1

## 1940 DIMENSIONS

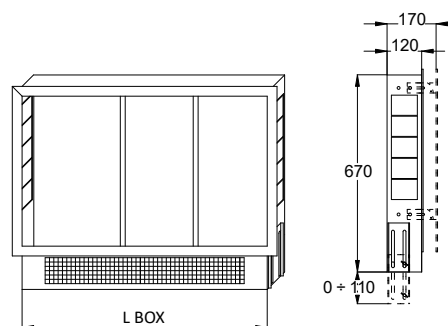

## GUIDE TO BOX SELECTION

MANIFOLD COMPATIBILITY: 3872POL

No. ways	L' (mm)	L' + valve (mm)	L BOX (mm)	Code
2	190	255	600	181 0020
3	235	300		
4	280	345		
5	325	390		
6	370	435	700	181 0016
7	415	480		
8	460	525		
9	505	570	850	181 0015
10	550	615		
11	595	660		
12	640	705		
13	685	750	1000	181 0019
14	730	795		
15	775	840		
16	820	885		

In order to determine the manifold/box match, the size of accessory ball valve has been taken into account.

\* Manifold width

 For the full range of accessories and spare parts, see page 130



Tiemme distribution manifolds, art. 3873JBYD - 3873RBYDJ are the ideal solution for heating/cooling systems. Available with 1"1/2 fittings with clocked male/female thread and 5÷14 ways with 1"x26.5 (1" inner diameter) fittings.

The manifolds include shut-off valves, thermometer support endings with manually positionable air vent valves, and system loading and unloading cocks.

Each way's inflow rate can be set via a manual screw that also serves as a stop valve.

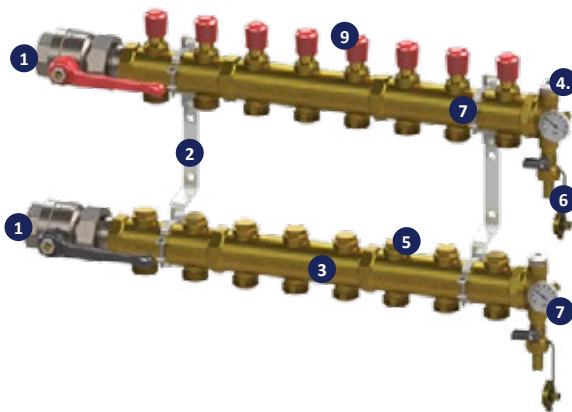

1. Full passage shut-off ball valves
2. Fixing brackets
3. Return manifold
4. Manual bleeding valve
5. Charging and relief valve
6. Screws
7. Inflow manifold
8. Thermometer
9. Adjusting screw

## PRODUCT RANGE

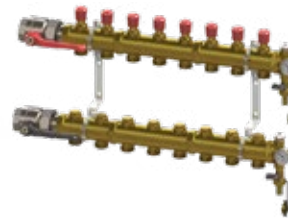

### 3874

1"1/2 manifold in pressed CW617N brass with 1" male fittings

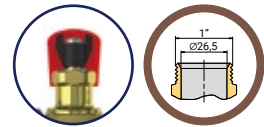

## DESCRIPTION

- Inflow and return manifold in CW617N brass
- 1" G fitting with adjusting screw on the inflow line
- 1"1/2 ball valves on feeding connections
- Thermometers
- Loading and unloading cocks
- Manual air vent valve
- Fixing brackets

Code	Type	Ways	Outgoes	Price €	Unit/Box
385 0074	1"1/2G	5	1" G		1/1
385 0075	1"1/2G	6	1" G		1/1
385 0076	1"1/2G	7	1" G		1/1
385 0077	1"1/2G	8	1" G		1/1
385 0078	1"1/2G	9	1" G		1/1
385 0079	1"1/2G	10	1" G		1/1
385 0080	1"1/2G	11	1" G		1/1
385 0081	1"1/2G	12	1" G		1/1
385 0082	1"1/2G	13	1" G		1/1
385 0083	1"1/2G	14	1" G		1/1

## 3874

### GUIDE TO FITTINGS

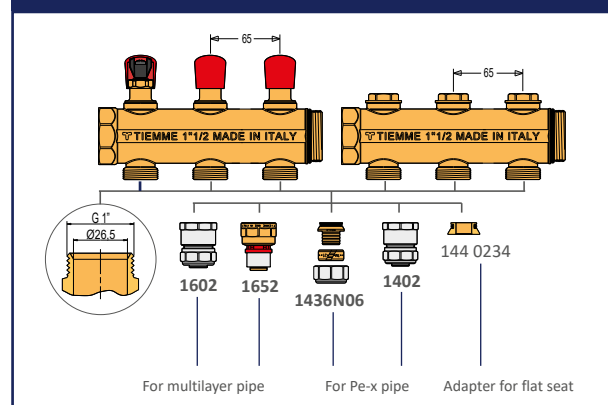

## ACCESSORIES AND SPARE PARTS



**1436N06**  
1" G fitting adapter for PE-X pipe

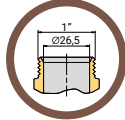

Code	Type	Price €	Unit/Box
144 0232	20 x 2.0 - 1" G		10/200
144 0075	25 x 2.3 - 1" G		10/200



**1859**  
Adapter to turn 1" G connection into plain end

Code	Type	Price €	Unit/Box
144 0234	1" G		10/300



**3874P**  
Protective cap

Code	Type	Price €	Unit/Box
179 0037	-		5/50



**1889TERMO**  
Female end fitting with clocked thread and thermometer support

Code	Type	Price €	Unit/Box
195 0064	1"1/2 x 1/2" x 1/2"		5/50



**9567KIT**  
INDUSTRIAL FLOOR adapter for 9567 electro-thermal controller

Code	Type	Price €	Unit/Box
179 0328	-		1/100

## 9567-9567KIT ASSEMBLY INSTRUCTION

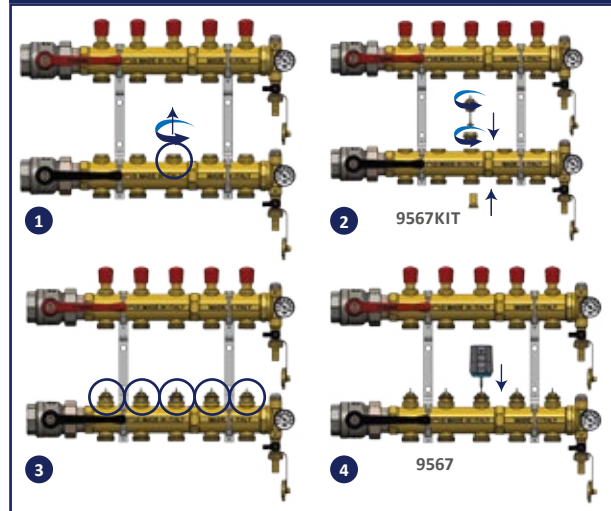

**3874ISOL**  
1"1/2 distribution manifold insulation shell

Code	Type	Price €	Unit/Box
557 0520	2 ways		1/5
557 0522	3 ways		1/5



**1890ISOL**  
1"1/4 - 1"1/2 end unit insulation shell and air vent valve

Code	Type	Price €	Unit/Box
557 0516	1"1/4 - 1"1/2		1/10





**2121CPISOL**  
1"1/2 insulation shell for ball valve

Code	Type	Price €	Unit/Box
557 0518	1"1/2		1/10

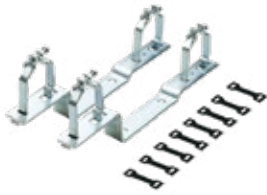

**1865**  
Universal support for INDUSTRIAL FLOOR pressed manifolds

Code	Type	Price €	Unit/Box
181 0007	1"1/2		1/25

## DIMENSIONS

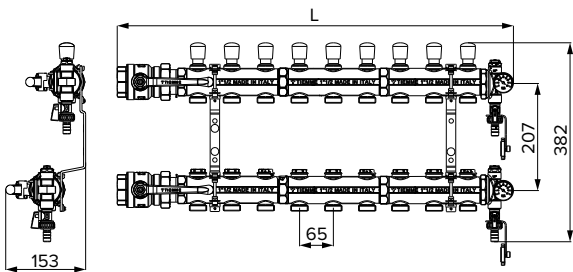

**1941**  
External box for INDUSTRIAL FLOOR manifolds

Code	Type	Price €	Unit/Box
181 0110	900 x 650 x 170		1/1
181 0111	1200 x 650 x 170		1/1

## 1941 DIMENSIONS

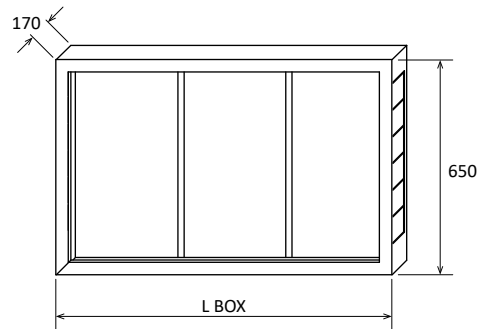

## GUIDE TO BOX SELECTION

MANIFOLD COMPATIBILITY: 3874

No. ways	L* (mm)	L BOX (mm)	Code
5	495	900	181 0110
6	560		
7	625		
8	690		
9	755		
10	820	1200	181 0111
11	885		
12	950		
13	1015		
14	1080		

\* Manifold width

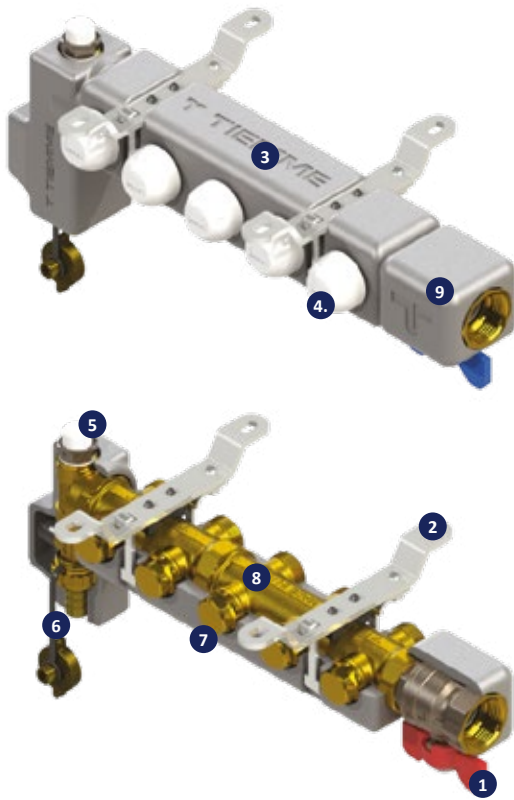

1. Full passage shut-off ball valves
2. Fixing brackets
3. Return manifold
4. Manual thermostatic shut-off valves (controlled with electro-thermal actuator) with protective cap
5. Manual bleeder valve
6. Charging and relief valve
7. Mechanical memory screws
8. Inflow manifold
9. Insulation shell

## PRODUCT RANGE

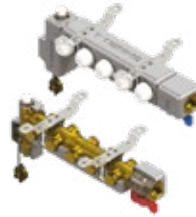

### 3878RS

1" distribution manifold with mechanical memory screws and insulation shells Ceiling specific configuration and installation systems

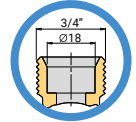

**i** Manifold for Tiemme CEILING systems

Code	Type	Ways	Price €	Unit/Box
557 0353	1"G	2		1/1
557 0354	1"G	3		1/1
557 0355	1"G	4		1/1
557 0356	1"G	5		1/1
557 0357	1"G	6		1/1
557 0358	1"G	7		1/1
557 0359	1"G	8		1/1
557 0360	1"G	9		1/1
557 0361	1"G	10		1/1
557 0362	1"G	11		1/1
557 0363	1"G	12		1/1





Pre-assembled distribution and mixing unit for radiant panel systems with fixed point control and offset manifolds.

The distribution and mixing unit, art. 3868G, is a simple and compact solution to create a radiant panel heating system and perfectly supports high temperature boilers. The thermostatic mixing unit mixes high-temperature and low-temperature water coming from radiant circuits. The value of the heat transfer fluid medium temperature is kept stable by a thermostatic actuator. Available with or without connections for high-temperature endings with 3/4" (Ø18) Eurocone fittings.

In compliance with European Directive 2009/125/CE (ErP) on energy savings, the unit comes with high-efficiency pumps.

### OPERATION PRINCIPLE

High-temperature water coming from the boiler (A) mixes by means of thermostatic valve (B) with water coming from return circuits of the floor system, thus reaching the flow temperature of the floor heating system which is set on the thermostatic head (C) and controlled by the immersion sensor (E).

The pump (G) sectioned by ball valves (F) favors fluid mixing, thus guaranteeing the head in radiant panel circuits. If the preset value (55°C) is exceeded, safety thermostat (H) immediately activates electrically and shuts down the pump. Water that has been mixed at desired temperature is then directed to the inflow manifold (N) of the floor system. The lockshield (O) allows to balance the system by setting the water flow going from the return manifold (D) towards the boiler (P).

A by-pass (R) always guarantees a minimum flow rate, thus preserving the pump and potential noise issues. The unit also includes a system loading/unloading valve (L) and a safety relief valve (M).

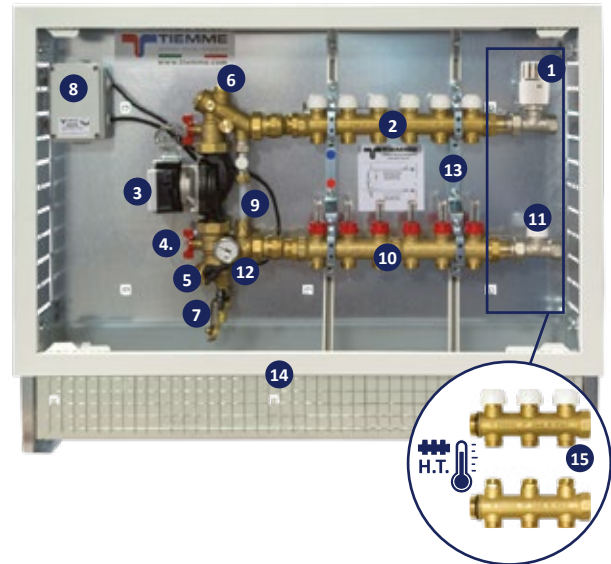
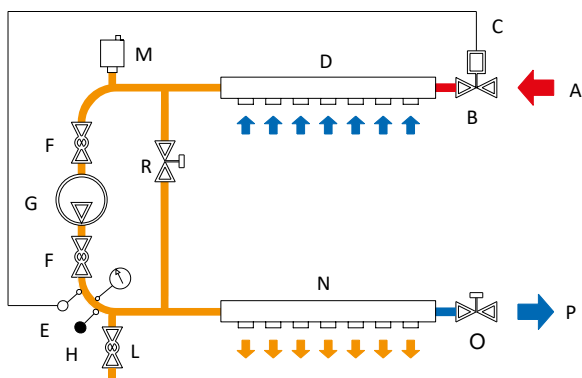

1. Mixing kit with fixed point and thermostatic control (20 ÷ 50 °C)
2. 1" inflow manifold with flow meters
3. High-efficiency pump
4. Shut-off ball valves
5. Safety thermostat
6. Air vent valve
7. Charging and relief valve
8. Kit for electrical connections
9. By-pass
10. 1" return manifold with thermostatic manual shut-off valves
11. Lockshield
12. Thermometers
13. Steel brackets
14. Steel box
15. High-temperature manifold

### TECHNICAL SPECIFICATIONS

- Inflow fluid max temperature: 110 °C
- Maximum pressure: 10 bar
- Primary circuit connections: 3/4" F
- Distribution manifold material: Brass CW617N
- O-ring material: EPDM
- Adjusting range: 20 ÷ 50 °C
- Safety thermostat: 55 °C preset

### PUMP

- Model: Wilo PARA 25/7
- Coupling: 1" 1/2
- Fittings spacing: 130 mm

### THERMOSTATIC HEAD:

- Ferrule fitting: M30 x 1.5
- Handle material: ABS

### DIMENSIONS

See table on page 129

3868G - 3868GHTPP2 - 3868GHTPP3



## 3868G

Distribution and mixing unit with fixed point control and by-pass

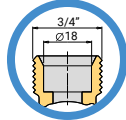

Code	Type	Ways	Price €	Unit/Box
391 0103	1"G	2		1/1
391 0110	1"G	3		1/1
391 0101	1"G	4		1/1
391 0098	1"G	5		1/1
391 0028	1"G	6		1/1
391 0077	1"G	7		1/1
391 0064	1"G	8		1/1
391 0111	1"G	9		1/1
391 0071	1"G	10		1/1
391 0059	1"G	11		1/1
391 0062	1"G	12		1/1



## 3868GHTPP3

Distribution and mixing unit with fixed point control, by-pass, and 3 way high-temperature kit

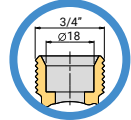

Code	Type	Ways	Price €	Unit/Box
391 0119	1"G	2		1/1
391 0120	1"G	3		1/1
391 0121	1"G	4		1/1
391 0122	1"G	5		1/1
391 0123	1"G	6		1/1
391 0124	1"G	7		1/1
391 0125	1"G	8		1/1
391 0126	1"G	9		1/1
391 0085	1"G	10		1/1
391 0127	1"G	11		1/1
391 0129	1"G	12		1/1



## 3868GHTPP2

Distribution and mixing unit with fixed point control, by-pass, and 2 way high-temperature kit

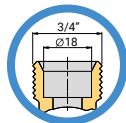

Code	Type	Ways	Price €	Unit/Box
391 0118	1"G	2		1/1
391 0097	1"G	3		1/1
391 0074	1"G	4		1/1
391 0036	1"G	5		1/1
391 0047	1"G	6		1/1
391 0029	1"G	7		1/1
391 0058	1"G	8		1/1
391 0052	1"G	9		1/1
391 0051	1"G	10		1/1
391 0061	1"G	11		1/1
391 0128	1"G	12		1/1



Pre-assembled distribution and mixing unit for radiant panel systems with fixed point control and offset manifolds.

The distribution and mixing unit, art. 3896PF, is a traditional solution consisting of a 3 way mixing valve that mixes high temperature water coming from the boiler with return water of the radiant system. Flow temperature is set on the thermostatic head located on the 3 way valve.

Available with or without connections for high-temperature endings with 3/4" (Ø18) Eurocone fittings.

In compliance with European Directive 2009/125/CE (ErP) on energy savings, the unit comes with high-efficiency pumps.

### OPERATION PRINCIPLE

High temperature water coming from the boiler passes through the ball valve (A) and mixes in the 3 way valve (C) with part of the water coming from the return manifold (I) of the floor system.

The temperature of the secondary circuit is kept at the preset value by the thermostatic head (D) depending on the temperature detected by the temperature bulb sensor (F). The pump (E) favors fluid mixing, thus guaranteeing the head in radiant panel circuits.

The safety thermostat (G) electrically activates and shuts down the pump in the event that the preset value (55°C) is exceeded. Water that has been mixed at desired temperature is then directed to the inflow line (H) of the floor system. Part of the low-temperature water returning from panels (I) enters the valve (C), thus mixing with the water coming from the boiler, while another part goes back to the boiler through the ball valve (B). The check valve (L) prevents possible high temperature water to access radiant circuits. The by-pass valve (M) allows to balance the system, thus guaranteeing a minimum flow rate of the primary circuit. High temperature circuits (heated towel rails) are fed through points (O) and (N).

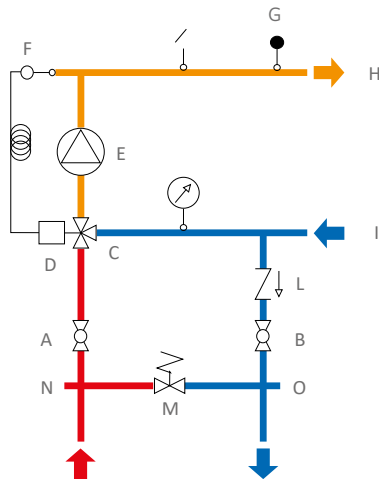

- |  |                                 |  |                    |
|--|---------------------------------|--|--------------------|
|  | Mixing thermostatic valve       |  | Check valve        |
|  | High-efficiency pump <b>ErP</b> |  | Temperature sensor |
|  | By-pass valve                   |  | Safety thermostat  |
|  | Ball valve                      |  | Thermometer        |

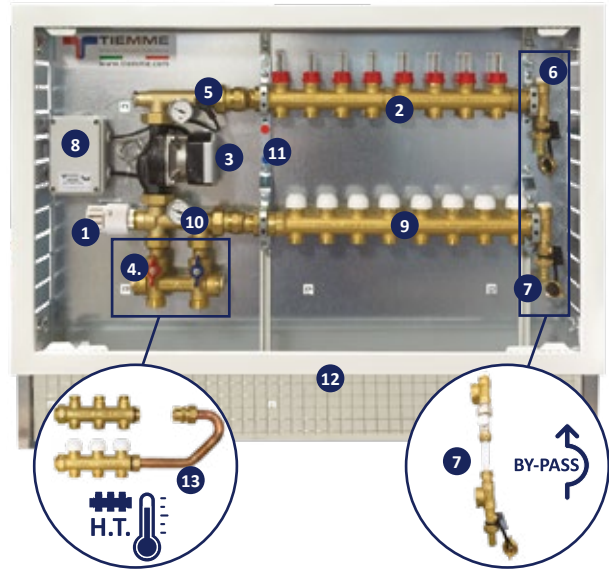

1. Mixing kit with fixed point and thermostatic control (20 ÷ 50 °C)
2. 1" inflow manifold with flow meters
3. High-efficiency pump
4. Shut-off ball valves
5. Safety thermostat
6. Air vent valve
7. Charging and relief/by-pass valve
8. Kit for electrical connections
9. 1" return manifold with thermostatic manual shut-off valves
10. Thermometers
11. Steel brackets
12. Steel box
13. High-temperature manifold

### TECHNICAL SPECIFICATIONS

- Inflow fluid max temperature: 110 °C
- Maximum pressure: 10 bar
- Primary circuit connections: 1" M
- Distribution manifold material: Brass CW617N
- O-ring material: EPDM
- Adjusting range: 20 ÷ 50 °C
- Safety thermostat: 55 °C preset

### PUMP

- Model: Wilo PARA 25/7
- Coupling: 1" 1/2
- Fittings spacing: 130 mm

### THERMOSTATIC HEAD:

- Ferrule fitting: M30 x 1.5
- Handle material: ABS

### DIMENSIONS

See table on page 129

# 04<sub>B</sub> DISTRIBUTION AND MIXING UNITS WITH FIXED POINT CONTROL - 1"

3896PF - 3896PFBY - 3896PFHT - 3896PFHTBY

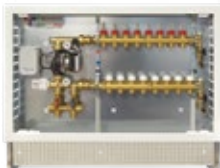

## 3896PF

Distribution and mixing unit with fixed point control

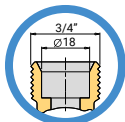

Code	Type	Ways	Price €	Unit/Box
390 0444	1"G	2		1/1
390 0445	1"G	3		1/1
390 0446	1"G	4		1/1
390 0447	1"G	5		1/1
390 0448	1"G	6		1/1
390 0449	1"G	7		1/1
390 0450	1"G	8		1/1
390 0451	1"G	9		1/1
390 0452	1"G	10		1/1
390 0453	1"G	11		1/1
390 0454	1"G	12		1/1

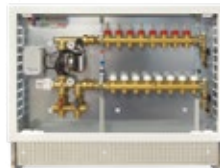

## 3896PFHT

Distribution and mixing unit with fixed point control and high-temperature kit

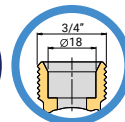

Code	Type	Ways	Price €	Unit/Box
390 0488	1"G	2		1/1
390 0489	1"G	3		1/1
390 0490	1"G	4		1/1
390 0491	1"G	5		1/1
390 0492	1"G	6		1/1
390 0493	1"G	7		1/1
390 0494	1"G	8		1/1
390 0495	1"G	9		1/1
390 0496	1"G	10		1/1
390 0497	1"G	11		1/1
390 0498	1"G	12		1/1

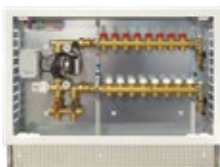

## 3896PFBY

Distribution and mixing unit with fixed point control and by-pass

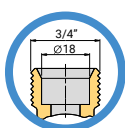

Code	Type	Ways	Price €	Unit/Box
390 0466	1"G	2		1/1
390 0467	1"G	3		1/1
390 0468	1"G	4		1/1
390 0469	1"G	5		1/1
390 0470	1"G	6		1/1
390 0471	1"G	7		1/1
390 0472	1"G	8		1/1
390 0473	1"G	9		1/1
390 0474	1"G	10		1/1
390 0475	1"G	11		1/1
390 0476	1"G	12		1/1

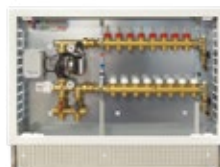

## 3896PFHTBY

Distribution and mixing unit with fixed point control, by-pass, and high-temperature kit

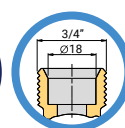

Code	Type	Ways	Price €	Unit/Box
390 0510	1"G	2		1/1
390 0511	1"G	3		1/1
390 0512	1"G	4		1/1
390 0513	1"G	5		1/1
390 0514	1"G	6		1/1
390 0515	1"G	7		1/1
390 0516	1"G	8		1/1
390 0517	1"G	9		1/1
390 0518	1"G	10		1/1
390 0519	1"G	11		1/1
390 0520	1"G	12		1/1



# 04<sub>B</sub> DISTRIBUTION AND MIXING UNITS WITH CLIMATE CONTROL - 1"

3896CL - 3896CLBY - 3896CLHT - 3896CLHTBY

Distribution and mixing unit with climate control for cooling and/or heating systems with radiant panels.

With a mixing unit with climate control, water coming from the heating/cooling generator is mixed with water returning from radiant circuits and kept at a constant desired value by a 0 ÷ 10 V controller with control unit.

Available with or without connections for high-temperature endings with 3/4" (Ø18) Eurocone fittings.

In compliance with European Directive 2009/125/CE (ErP) on energy savings, the unit comes with high-efficiency pumps.

## OPERATION PRINCIPLE

High temperature water coming from the boiler passes through the ball valve (A) and mixes in the 3 way valve (C) with part of the water coming from the return manifold (I) of the floor system.

The temperature of the secondary circuit is kept at the preset value by a 0 ÷ 10 V controller (D), operated by an optional control unit, depending on the temperature detected by the NTC temperature sensor (F). The pump (E) favors fluid mixing, thus guaranteeing the head in radiant panel circuits.

The safety thermostat (G) electrically activates and shuts down the pump in the event that the preset value (55°C) is exceeded. Water that has been mixed at desired temperature is then directed to the inflow line (H) of the floor system. Part of the low-temperature water returning from panels (I) enters the valve (C), thus mixing with the water coming from the boiler, while another part goes back to the boiler through the ball valve (B). The check valve (L) prevents possible high temperature water to access radiant circuits. The by-pass valve (M) allows to balance the system, thus guaranteeing a minimum flow rate of the primary circuit. High temperature circuits (heated towel rails) are fed through points (O) and (N).

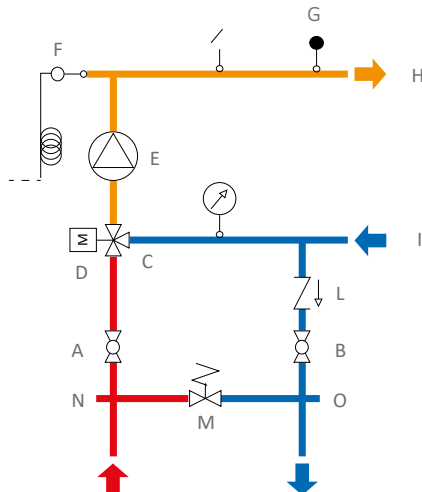

- |  |                        |  |                    |
|--|------------------------|--|--------------------|
|  | Mixing motorized valve |  | Check valve        |
|  | High-efficiency pump   |  | Temperature sensor |
|  | By-pass valve          |  | Safety thermostat  |
|  | Ball valve             |  | Thermometer        |

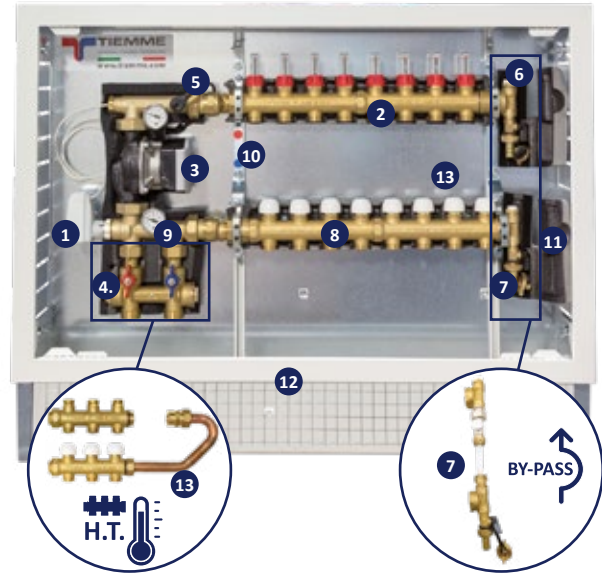

- Mixing kit with climate control (0÷10 V controller and NTC sensor)
- 1" inflow manifold with flow meters or mechanical memory screws
- High-efficiency pump
- Shut-off ball valves
- Safety thermostat
- Air vent valve
- Charging and relief/by-pass valve
- 1" return manifold with thermostatic manual shut-off valves
- Thermometers
- Steel brackets
- Insulation shell
- Steel box
- High-temperature manifold

## TECHNICAL SPECIFICATIONS

- Inflow fluid max temperature: 110 °C
- Maximum pressure: 10 bar
- Primary circuit connections: 1" M
- Distribution manifold material: Brass CW617N
- O-ring material: EPDM
- Adjusting range: 7 ÷ 50 °C
- Safety thermostat: 55 °C preset

## PUMP

- Model: Wilo PARA 25/7
- Coupling: 1" 1/2
- Fittings spacing: 130 mm

## DIMENSIONS

See table on page 129

# 04<sub>B</sub> DISTRIBUTION AND MIXING UNITS WITH CLIMATE CONTROL - 1"

3896CL - 3896CLBY - 3896CLHT - 3896CLHTBY

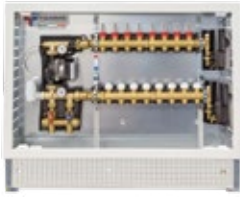

## 3896CL

Distribution and mixing unit with climate control

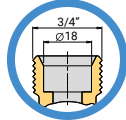

Code	Type	Ways	Price €	Unit/Box
390 0532	1"G	2		1/1
390 0533	1"G	3		1/1
390 0534	1"G	4		1/1
390 0535	1"G	5		1/1
390 0536	1"G	6		1/1
390 0537	1"G	7		1/1
390 0538	1"G	8		1/1
390 0539	1"G	9		1/1
390 0540	1"G	10		1/1
390 0541	1"G	11		1/1
390 0542	1"G	12		1/1



## 3896CLHT

Distribution and mixing unit with climate control and high-temperature kit

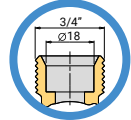

Code	Type	Ways	Price €	Unit/Box
390 0576	1"G	2		1/1
390 0577	1"G	3		1/1
390 0578	1"G	4		1/1
390 0579	1"G	5		1/1
390 0580	1"G	6		1/1
390 0581	1"G	7		1/1
390 0582	1"G	8		1/1
390 0583	1"G	9		1/1
390 0584	1"G	10		1/1
390 0585	1"G	11		1/1
390 0586	1"G	12		1/1

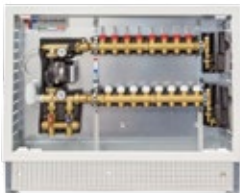

## 3896CLBY

Distribution and mixing unit with climate control and by-pass

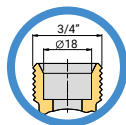

Code	Type	Ways	Price €	Unit/Box
390 0554	1"G	2		1/1
390 0555	1"G	3		1/1
390 0556	1"G	4		1/1
390 0557	1"G	5		1/1
390 0558	1"G	6		1/1
390 0559	1"G	7		1/1
390 0560	1"G	8		1/1
390 0561	1"G	9		1/1
390 0562	1"G	10		1/1
390 0563	1"G	11		1/1
390 0564	1"G	12		1/1

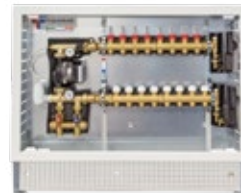

## 3896CLHTBY

Distribution and mixing unit with climate control, by-pass, and high-temperature kit

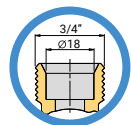

Code	Type	Ways	Price €	Unit/Box
390 0598	1"G	2		1/1
390 0599	1"G	3		1/1
390 0600	1"G	4		1/1
390 0601	1"G	5		1/1
390 0602	1"G	6		1/1
390 0603	1"G	7		1/1
390 0604	1"G	8		1/1
390 0605	1"G	9		1/1
390 0606	1"G	10		1/1
390 0607	1"G	11		1/1
390 0608	1"G	12		1/1



# 04<sub>B</sub> DISTRIBUTION AND MIXING UNITS - 1"

## 3868G - 3868GHTPP2 3868GHTPP3 SIZE

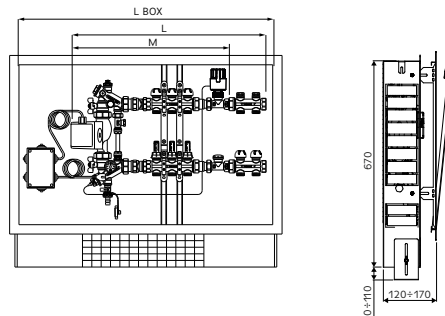

MANIFOLD KIT SIZE - 3868G

No. ways	2	3	4	5	6	7	8	9	10	11	12	
M (mm)	460	510	560	610	660	710	760	810	860	910	960	
L BOX (mm)	600		700			850			1000			1200

KIT SIZE WITH 2 WAY HIGH-TEMPERATURE MANIFOLD - 3868GHTPP2

No. ways	2	3	4	5	6	7	8	9	10	11	12
M (mm)	580	630	680	730	780	830	880	930	980	1030	1080
L BOX (mm)	700		850			1000			1200		

KIT SIZE WITH 3 WAY HIGH-TEMPERATURE MANIFOLD - 3868GHTPP3

No. ways	2	3	4	5	6	7	8	9	10	11	12
M (mm)	630	680	730	780	830	880	930	980	1030	1080	1130
L BOX (mm)	700	850			1000			1200			

## 3896PF - 3896PFBY 3896PFHT - 3896PFHTBY SIZE

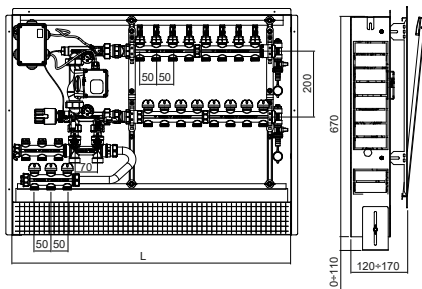

No. ways	2	3	4	5	6	7	8	9	10	11	12	
L (mm)	600		700			850			1000			1200

## 3896CL - 3896CLBY 3896CLHT - 3896CLHTBY SIZE

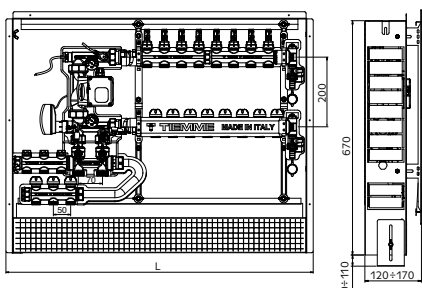

No. ways	2	3	4	5	6	7	8	9	10	11	12	
L (mm)	600		700			850			1000			1200



**1436N**  
Nickel-plated adapter with 3/4"x18 fitting (EUROCONO) for PEX pipe

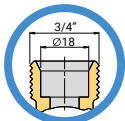

Code	Type	Price €	Unit/Box
144 0011	16 x 2.0 - 3/4" (ø18)		10/250
144 0012	17 x 2.0 - 3/4" (ø18)		10/200
144 0019	20 x 2.0 - 3/4" (ø18)		10/200



**1636N**  
Nickel-plated adapter with 3/4"x18 fitting (EUROCONO) for multilayer pipe

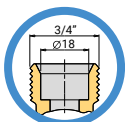

Code	Type	Price €	Unit/Box
144 0002	16 x 2.0 - 3/4" (ø18)		10/250
144 0003	20 x 2.0 - 3/4" (ø18)		10/200



**9567**  
Electro-thermal controller with travel indicator

**TECHNICAL SPECIFICATIONS**

- Operating temperature: 24-230 Vac, 50/60 Hz
- Operating power: 1 W
- Inrush current: max 550 mA for max 100 ms
- Travel: 4 mm
- Protection class: II
- Protection rating: IP 54
- Room temperature: 0°C ÷ 60°C
- Storage temperature: -25°C ÷ 60°C

**i** Normal position of closed valve with no voltage

**+** With "FIRST OPENING" function: allows to ease first installation on the manifold. For further details, please see technical specifications.

Code	Type	Price €	Unit/Box
450 0026	24V		1/20
450 0012	230V		1/20
450 0045	24V		1/20
450 0006	230V		1/20

Version with auxiliary microswitch



**9568**  
Electrothermal actuator (for thermostatic valves and polyamid manifold art. 3872POL - 3871PMON)

**TECHNICAL SPECIFICATIONS**

- Operating temperature: 24-230 Vac, 50/60 Hz
- Operating power: 1 W
- Inrush current: max 550 mA for max 100 ms
- Travel: 4 mm
- Protection class: II
- Protection rating: IP 54
- Room temperature: 0°C ÷ 60°C
- Storage temperature: -25°C ÷ 60°C

**i** TO BE COUPLED WITH A 3872POL MANIFOLD.

**i** Normal position of closed valve with no voltage.

**+** With "FIRST OPENING" function: allows to ease first installation on the manifold. For further details, please see technical specifications.

Code	Type	Price €	Unit/Box
450 0543	24V		1/20
450 0539	230V		1/20
450 0545	24V		1/20
450 0541	230V		1/20

Version with auxiliary microswitch







**9561KIT01**  
Thermostatic head with distance sensor and 1/2" fitting well. Adjusting range: 20-50°C

Code	Type	Price €	Unit/Box
450 0032	20-50°C		1/10





**2075KIT01**  
Bimetallic safety button thermostat with M4 fixing screw. Operating temperature: 55°C. Contact flow rate (usually closed): 10A 250Vac. Comes with a connection cable.

Code	Type	Price €	Unit/Box
450 0051	55°C		1/50



**2075KIT02**  
Kit of electrical connections for mixing units, pump control, auxiliary contact for boiler or zone valve, inlet for room thermostat and safety thermostat

-  Removable terminal board to facilitate installation
-  Comes with cables to connect pump and safety thermostat

Code	Type	Price €	Unit/Box
450 0063	120 x 80 x H60 mm		1/1



**3887**  
Multifunction ball valve for distribution and mixing unit

Code	Type	Price €	Unit/Box
450 0050	1"		2/6



**3895KPF**  
Control kit with 20±50°C fixed point



- SPECIFICATION**
- Thermostat head with external bulb and 20±50°C adjusting range
  - Well to support bulb sensor
  - Box for electrical connections (pump and safety thermostat)

Code	Type	Price €	Unit/Box
450 0376	-		1/1



**3890BV**  
Kit with shut-off valves, by-pass, and fittings for high temperature distribution manifolds

Code	Type	Price €	Unit/Box
450 0082	1"		1/10



**3895KCL**  
Heating and cooling kit



- DESCRIPTION**
- 24V-fed 0÷10V NC controller
  - Sensor supporting Ø6 well with dry installation
  - Safety thermostat connection cable
  - NTC 10K@25°C, 6 mm diameter temperature sensor

Code	Type	Price €	Unit/Box
450 0377	-		1/1

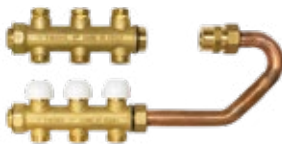

**3895KHT**  
Kit for high temperature distribution

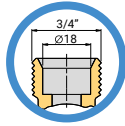

**DESCRIPTION**

- 1" brass distribution 3 way manifolds with 3/4"x18 Eurocone fittings and thermostatic screws
- 1" brass distribution 3 way manifolds with 3/4"x18 Eurocone fittings and mechanical memory screws
- Connecting fittings

Code	Type	Price €	Unit/Box
450 0378	1" 3 ways		1/1



**3890PW2**  
Wilo PARA 25/7 high efficiency pump with 130 mm spacing. 1 1/2 fitting

**HIGH-EFFICIENCY PUMP**

Code	Type	Price €	Unit/Box
450 0358	Wilo PARA 25/7		1/1



**3889**  
1 1/2 pump fitting with ball valve and 1" female fitting

Code	Type	Pump fitting	Price €	Unit/Box
450 0031	1"	1 1/2"		2/40



**3888**  
1 1/2 pump fitting with ball valve and copper pipe connection

Code	Type	Pump fitting	Price €	Unit/Box
450 0041	22	1 1/2"		1/50
450 0044	28	1 1/2"		1/50



**1555SET**  
Pump fitting brass kit with flat seat male connection

**i** The kit includes: 2 tails, 2 nuts and 2 gaskets

Code	Type	Pump fitting	Price €	Unit/Box
150 0825	1/2"	3/4"		1/50
150 0826	3/4"	1"		1/50
150 0827	1"	1 1/4"		1/25
150 0578	1 1/4"	1 1/2"		1/20



**1557SET**  
Female pump fitting kit with flat seat

**i** The kit includes: 2 tails, 2 nuts and 2 gaskets

Code	Type	Pump fitting	Price €	Unit/Box
150 0906	1/2"	1"		1/50
150 0839	3/4"	1 1/4"		1/25
150 0355	1"	1 1/2"		1/20
150 0440	1 1/4"	2"		1/10





**H9709**  
Flow meter for FLOOR pressed brass distribution manifold

Code	Type	Price €	Unit/Box
040 0196	-		5/100



**H9708**  
Thermostatic screw for FLOOR pressed brass distribution manifold

Code	Type	Price €	Unit/Box
040 0241	-		10/50



**2070**  
Ø 40 thermometer with L=30 mm fitting and 0 ÷ 80°C range

Code	Type	Price €	Unit/Box
179 0006	-		10/50



**3352**  
Manual safety relief valve with screw driver slot.

Code	Type	Price €	Unit/Box
198 0018	1/2"		10/500



**2990G**  
BOILER water loading/unloading ball valve

Code	Type	Price €	Unit/Box
295 0001	1/2"		25/100
295 0040	1/2"		10/50

Version with metal strap



**3049SKIT**  
Fixing kit for pressed "FLOOR" manifolds

Code	Type	Price €	Unit/Box
385 0063	1"		1/5

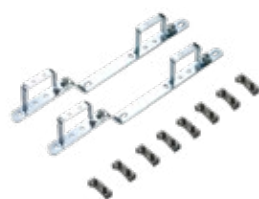

**1863**  
Support for "FLOOR" pressed manifolds for 1931-1939-1940 boxes

Code	Type	Price €	Unit/Box
181 0032	1"		1/25
181 0203	1"1/4		1/25

New code



# 05 HYDRAULIC SEPARATORS, DISTRIBUTION MANIFOLDS AND PUMPING STATIONS FOR CENTRAL HEATING SYSTEM

## 05A Introduction

Hydraulic units for central heating system	136
--	-----

## 05B Hydraulic separators

Hydraulic separators - introduction	137
-------------------------------------	-----

Steel hydraulic separators	 138
----------------------------	---

Brass hydraulic separators	 141
----------------------------	---

## 05C Manifolds for central heating system

Steel manifolds	 143
-----------------	--

Modular brass manifolds	 144
-------------------------	---

## 05D Control and pumping stations

DN25 Hydraulic power units	 153
----------------------------	---

DN32 Hydraulic power units	 158
----------------------------	---

Accessories	 160
-------------	---

A good solution to control and distribute fluid in the system is to use specific hydraulic mixing units for boiler rooms, also called central heating system, with distribution manifolds.

This chapter describes a full range of solutions for fluid management in a central heating system:

- Steel and brass hydraulic separators to separate the primary generating circuit from the secondary one.
- Steel and brass manifolds for central heating system to connect units to the generator;
- Hydraulic pumping, fixed point mixing, and modulating mixing stations

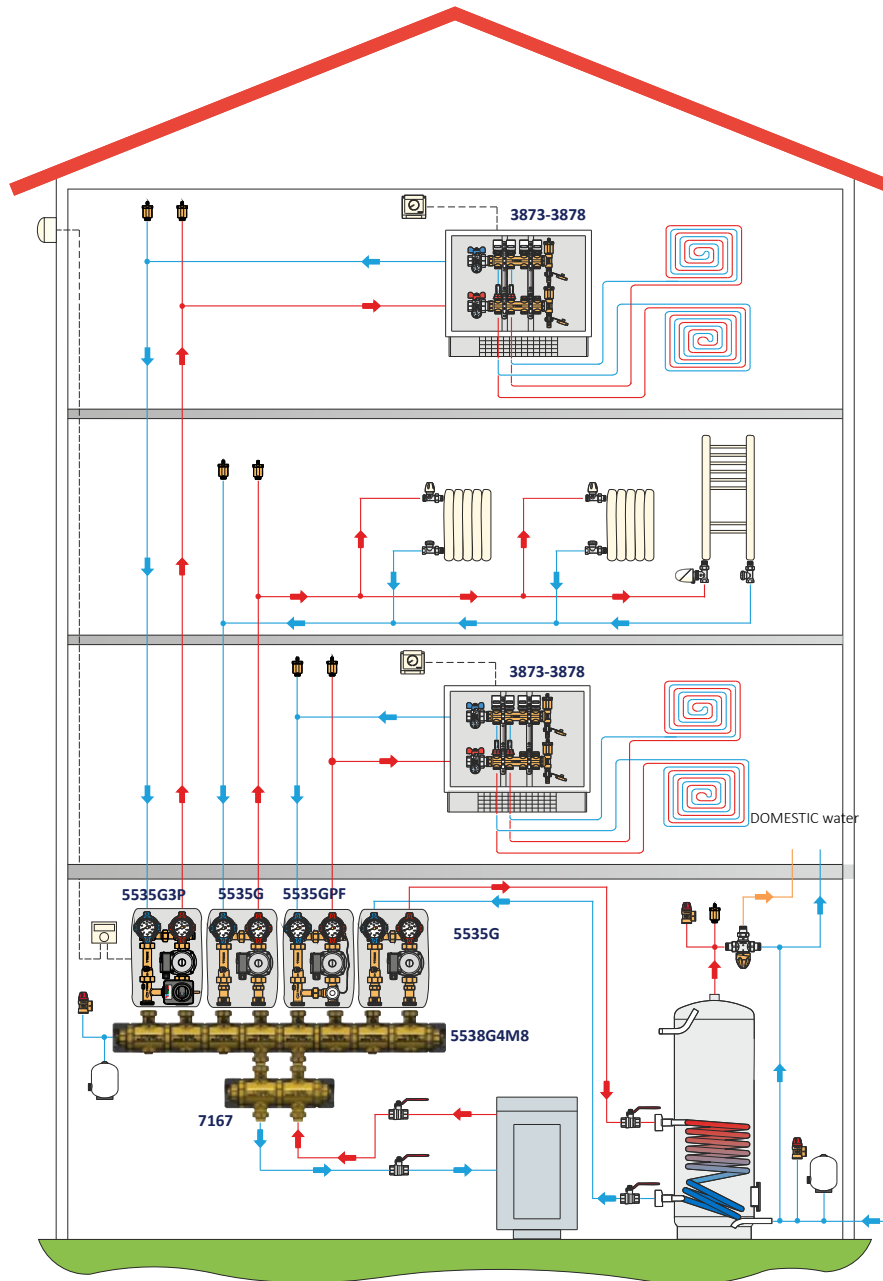

#### VIDEO TUTORIAL



Pumping stations



# 05<sub>B</sub> HYDRAULIC SEPARATORS - INTRODUCTION

The hydraulic separator is used to make the primary circuit (heat generator) totally independent from the secondary circuit (utilities), thus compensating for possible differences in the flow rate or for required pressure drop, and preventing installed series of circulating pumps to affect each other.

It can be employed in cooling and heating systems including at least a main circulating pump and one or more secondary distribution pumps.

The hydraulic separator consists of a container usually placed in a vertical position and characterized by high internal flow sections, thus showing reduced pressure drop. It has 4 side fittings, two top fittings and two bottom fittings, enabling connection of the primary and secondary circuits.

In the event that the flow rate of the primary and secondary circuits are identical (condition 2), the hydraulic separator does not serve any purpose, while if one of the two currents has a higher flow rate (conditions 1-3), the hydraulic separator directs a part of said flow rate to the other current, so as to balance the two flows.

In this way, interferences between pumps of various circuits can be avoided, thus improving fluid circulation and guaranteeing the proper functioning of each circuit at designed conditions.

Below there is a graphic representation of the three hydraulic balance conditions that can occur in the separator:

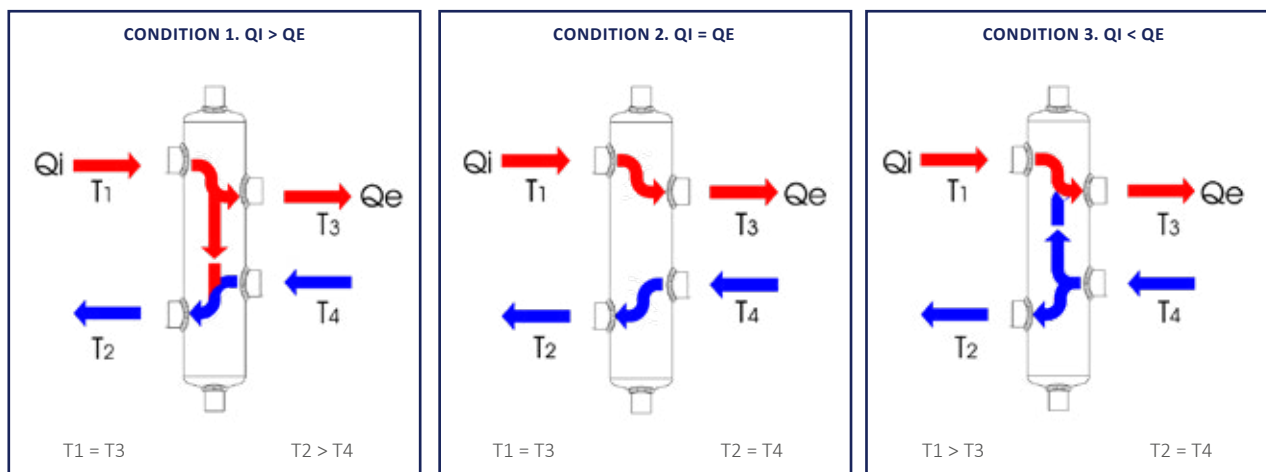

where:

$Q_i$  = primary circuit flow rate

$Q_e$  = secondary circuit flow rate

$T_1$  = Primary circuit flow temperature

$T_2$  = Primary circuit return temperature

$T_3$  = Secondary circuit flow temperature

$T_4$  = Secondary circuit return temperature

The design phase should take into account possible temperature variations that primary and secondary circuits can experience due to their mixing in the separator.

## ADVANTAGES / STRENGTHS

- Separating function;
- Dirt separating function;
- Available with or without insulation shell;
- Professional deaerator (art. 1896);
- Can be turned in a magnetic version with 3144MAG accessory (art. 3165 - art. 3165ISOL).



**3165**  
Threaded hydraulic separator

### TECHNICAL SPECIFICATIONS

- Body material: Fe 360 steel painted with epoxy powder
- Max operating pressure: 10 bar
- Max operating temperature: 110°C

**i** Can be turned into a magnetic version with 3144MAG accessory.

Code	Type	Flow rate	Price €	Unit/Box
316 0006	1"	2.5 (m³/h)		1/1
316 0003	1"1/4	4.0 (m³/h)		1/1
316 0004	1"1/2	6.0 (m³/h)		1/1
316 0005	2"	9.0 (m³/h)		1/1



**3165ISOL**  
Threaded insulated hydraulic separator

### TECHNICAL SPECIFICATIONS

- Body material: Fe 360 steel painted with epoxy powder
- Insulation shell material: Foamed closed-cell PE-X
- Max operating pressure: 10 bar
- Max operating temperature: 100°C

**i** Can be turned into a magnetic version with 3144MAG accessory.

Code	Type	Flow rate	Price €	Unit/Box
316 0001	1"	2.5 (m³/h)		1/1
316 0002	1"1/4	4.0 (m³/h)		1/1
316 0008	1"1/2	6.0 (m³/h)		1/1
316 0007	2"	9.0 (m³/h)		1/1



**3167ISOL**  
Flanged insulated hydraulic separator

### TECHNICAL SPECIFICATIONS

- Body material: Fe 360 steel
- Insulation shell material: PPE
- Max operating pressure: 10 bar
- Max operating temperature: 100°C

Code	Type	Flow rate	Price €	Unit/Box
316 0106	DN50	9 (m³/h)		1/1
316 0107	DN65	20 (m³/h)		1/1
316 0108	DN80	25 (m³/h)		1/1
316 0109	DN100	40 (m³/h)		1/1
316 0110	DN125	65 (m³/h)		1/1
316 0111	DN150	95 (m³/h)		1/1

With a base for floor support





### ADVANTAGES / STRENGTHS

- Separating function
- Dirt separating function
- Magnetic function
- Available with or without insulation shell
- Professional deaerator (art. 1896);



### 3144

Threaded magnetic hydraulic separator



#### TECHNICAL SPECIFICATIONS

- Body material: Fe 360 steel painted with epoxy powder
- Max operating pressure: 10 bar
- Max operating temperature: 110°C

Code	Type	Flow rate	Price €	Unit/Box
314 0001	1"	2.5 (m³/h)		1/1
314 0002	1"1/4	4.0 (m³/h)		1/1
314 0003	1"1/2	6.0 (m³/h)		1/1
314 0004	2"	9.0 (m³/h)		1/1



### 3144ISOL

Threaded insulated magnetic hydraulic separator



#### TECHNICAL SPECIFICATIONS

- Body material: Fe 360 steel painted with epoxy powder
- Insulation shell material: Foamed closed-cell PE-X
- Max operating pressure: 10 bar
- Max operating temperature: 100°C

Code	Type	Flow rate	Price €	Unit/Box
314 0005	1"	2.5 (m³/h)		1/1
314 0006	1"1/4	4.0 (m³/h)		1/1
314 0007	1"1/2	6.0 (m³/h)		1/1
314 0008	2"	9.0 (m³/h)		1/1

### ACCESSORIES AND SPARE PARTS



### 3144MAG

Well kit with magnet



Code	Type	Price €	Unit/Box
316 0105	1/2"		1/25

## DESCRIPTION OF COMPONENTS

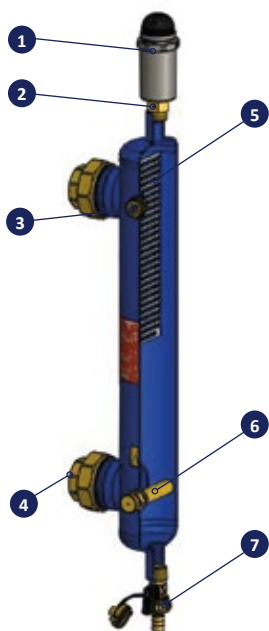

1. **Automatic air vent valve:** allows to eliminate air from the system
2. **Block and shut-off valve:** allows to maintain/replace the air vent valve without having to empty the system.
3. **Threaded G 1/2" fitting (with cap):**  
(art. 3144 - 3144ISOL - 3165 - 3165ISOL)  
allows to install a sensor-supporting well (art. 9561T) so as to monitor inflow temperature.
4. **3-Piece fittings with flat seat:**  
(art. 3144 - 3144ISOL - 3165 - 3165ISOL)  
facilitate the installation of the separator.
5. **Metal mesh:** favors the separation of dirt and directs air bubble towards the air vent valve placed at the top end of the separator.
6. **12,000 Gauss magnet:**  
(art. 3144 - 3144ISOL)  
placed in the bottom part of the device, it allows to improve filtering efficiency, by means of a magnetic field that captures ferrous impurities existing in the system.
7. **Loading/safety relief valve:** useful to load the system and eliminate sediments deposited in the separator.

## DIMENSIONS

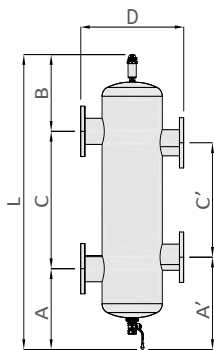
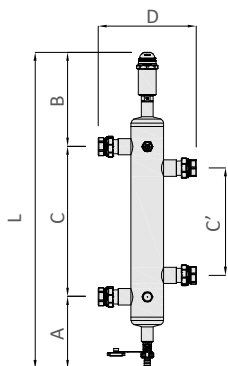

\*With a base for floor support

Art.	Code	Size	A (mm)	A' (mm)	B (mm)	C (mm)	C' (mm)	D (mm)	L (mm)	Volume (liters)
3165	316 0006	G 1" F	165	215	220	350	250	229	735	1.9
	316 0003	G 1"1/4 F	165	215	220	350	250	269	735	2.65
	316 0004	G 1"1/2 F	190	240	245	500	400	320	935	6
	316 0005	G 2" F	190	240	245	650	550	338	1085	11.5
3165ISOL	316 0001	G 1" F	165	215	220	350	250	229	735	1.9
	316 0002	G 1"1/4 F	165	215	220	350	250	269	735	2.65
	316 0008	G 1"1/2 F	190	240	245	500	400	320	935	6
	316 0007	G 2" F	190	240	245	650	550	338	1085	11.5
3144	314 0001	G 1" F	165	215	220	350	250	229	735	1.9
	314 0002	G 1"1/4 F	165	215	220	350	250	269	735	2.65
	314 0003	G 1"1/2 F	190	240	245	500	400	320	935	6
	314 0004	G 2" F	190	240	245	650	550	338	1085	11.5
3144ISOL	314 0005	G 1" F	165	215	220	350	250	229	735	1.9
	314 0006	G 1"1/4 F	165	215	220	350	250	269	735	2.65
	314 0007	G 1"1/2 F	190	240	245	500	400	320	935	6
	314 0008	G 2" F	190	240	245	650	550	338	1085	11.5
3167ISOL	316 0106	DN50	340	365	320	320	270	350	980	11
	316 0107	DN65	350	375	335	400	350	400	1085	18
	316 0108	DN80	350	400	335	500	400	500	1185	34
	316 0109	DN100	350	400	335	600	500	520	1285	60
	*316 0110	DN125	575	650	335	750	600	520	1660	68
	*316 0111	DN150	580	655	340	1000	850	600	1920	140



## ADVANTAGES / STRENGTHS

- Extremely compact;
- Can be complemented with Tiemme central system brass manifolds;
- Comes with insulation shell;
- Available with integrated shut-off valve (art. 7167).



**7166**  
Hydraulic separators with insulation shell

### TECHNICAL SPECIFICATIONS

- Max operating temperature: 100 °C
- Max operating pressure: 10 bar
- Body and components: Brass CW617N
- Outlets and fittings: 1" male thread
- Brackets: Galvanized steel
- Insulation shell: Cross-linked foam closed-cell polyethylene (PEX)
- Spacing: 125 mm

Code	Section	Flow rate	Price €	Unit/Box
316 0050	1"	2.5 (m³/h)		1/1



**7167**  
Hydraulic separators with insulation shell and valves

### TECHNICAL SPECIFICATIONS

- Max operating temperature: 100 °C
- Max operating pressure: 10 bar
- Body and components: Brass CW617N
- Outlets and fittings: 1" male thread
- Brackets: Galvanized steel
- Insulation shell: Cross-linked foam closed-cell polyethylene (PEX)
- Spacing: 125 mm

Code	Section	Flow rate	Price €	Unit/Box
316 0065	1"	2.5 (m³/h)		1/1

## 7166 DIMENSIONS

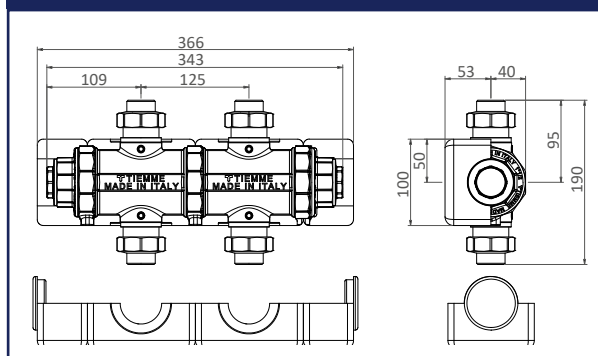

## 7167 DIMENSIONS

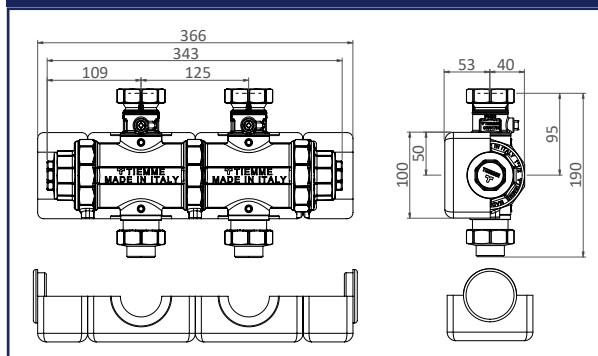

## FUNCTIONING

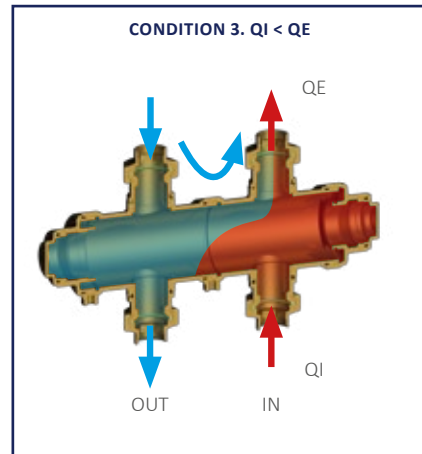
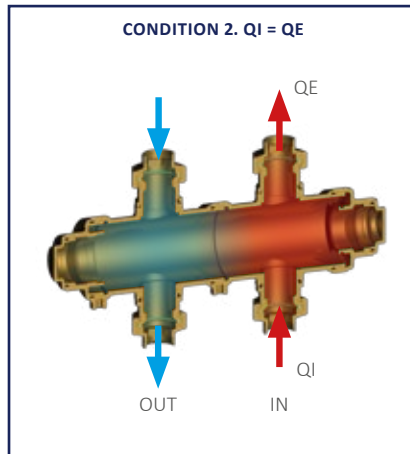
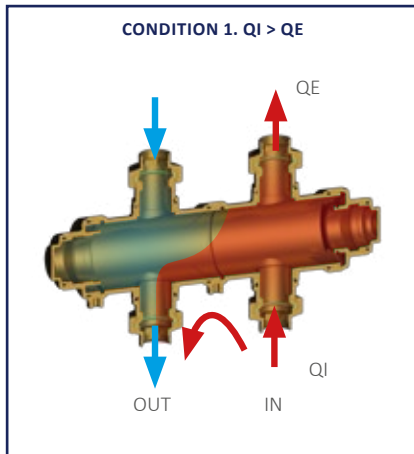

$Q_I$ : primary circuit flow rate  
 $Q_E$ : secondary circuit flow rate

## EXAMPLES OF ARRANGEMENTS

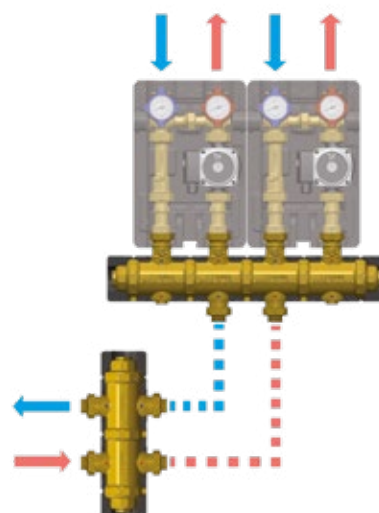
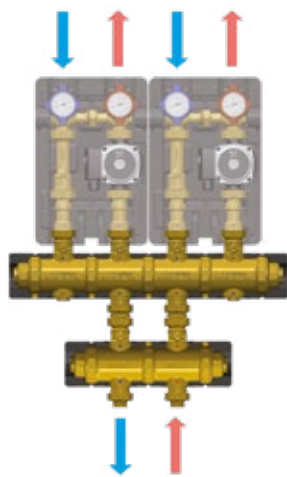

In order to meet any system need, Tiemme offers a series of steel compact manifolds to complement different pumping stations. Used in cooling and/or heating systems, they enable different thermal configurations in different environments, with only one heat generator or chiller, thus offering a compact solution that is easy to install. With insulation shell and available to feed up to 4 or 6 circuits, according to the model, they have 1"1/2 outlet fittings with flat seat and 125mm circuit spacing. Tiemme gives you the possibility of choosing a manifold with integrated hydraulic separator, art. 5539X, so as to offer easy installation and save domestic room. Tiemme steel compact manifolds, art. 5538X - 5540X - 5539X, come with pre-formed insulation shell, to guarantee perfect thermal insulation with both heating systems alone and cooling/heating systems.



**5539X**  
Steel hydraulic separator/  
manifold with insulation shell  
and fixing brackets, 125 mm  
circuit spacing, 1"1/2 fittings  
with flat seat and cap



Code	Section	No. circuits	Flow rate	Price €	Unit/Box
557 0001	80 x 80	2	3.0 (m³/h)		1/1
557 0002	80 x 80	3	3.0 (m³/h)		1/1
557 0003	120 x 120	2	7.0 (m³/h)		1/1
557 0004	120 x 120	3	7.0 (m³/h)		1/1
557 0005	120 x 120	4	7.0 (m³/h)		1/1

## 5539X

### OPERATION

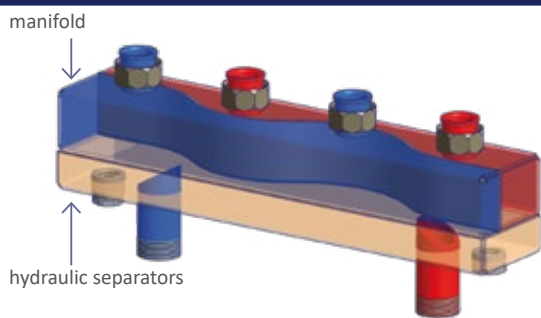

## 5538X 5540X

Steel manifold with insulation  
shell and fixing brackets, 125  
mm circuit spacing, 1"1/2  
fittings with flat seat and cap



Code	Section	No. circuits	Flow rate	Price €	Unit/Box
557 0006	80 x 60	2	3.0 (m³/h)		1/1
557 0007	80 x 60	3	3.0 (m³/h)		1/1
557 0008	120 x 80	3	6.5 (m³/h)		1/1
557 0009	120 x 80	4	6.5 (m³/h)		1/1
557 0010	120 x 80	5	6.5 (m³/h)		1/1
557 0366	120 x 80	6	6.5 (m³/h)		1/1



## 5540X

Couple of floor soundproofing  
and galvanized shelves

**i** 120x80 section accessory for manifold

Code	Type	Price €	Unit/Box
557 0011	h= 405-600 mm		1/1

Tiemme modular brass manifolds for central system are the result of a company's project aiming to create a unique and adaptable component that could be offered to their customers.

Central system manifolds are used in climate control systems that require different heating and cooling operations in different environments. The heat generator (boiler, closed fireplace, etc...) or heat pump represent the primary circuit with its dedicated circulating pump, while secondary circuits, with a dedicated circulating pump, are installed on the central system distribution manifold, according to required ways. This connection between primary and secondary circuits, at normal conditions create unexpected interferences, characterized by flow rate changes and secondary circuit head, as it is not possible to install a series of two or more circulating pumps. Therefore, a hydraulic separator should be placed between the primary and secondary circuits (with a distribution manifold) so that the two primary and secondary circuits will work independently without generating operating anomalies.

## FUNCTIONING

Tiemme brass manifold is available in two arrangements: art. 5538G, for a 2.2 m<sup>3</sup>/h flow rate (up to 3 m<sup>3</sup>/h max) with a peculiar coaxial shape (pipe into pipe).

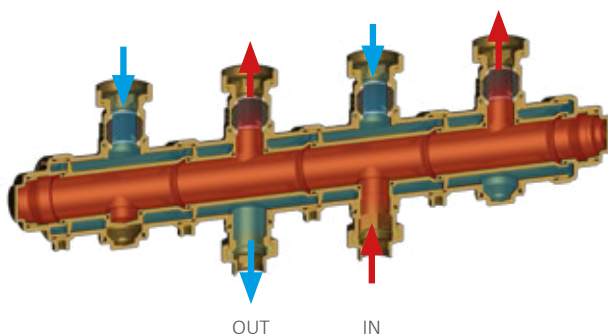

art. 5540G, for a 6.5 m<sup>3</sup>/h flow rate (up to 10 m<sup>3</sup>/h max).

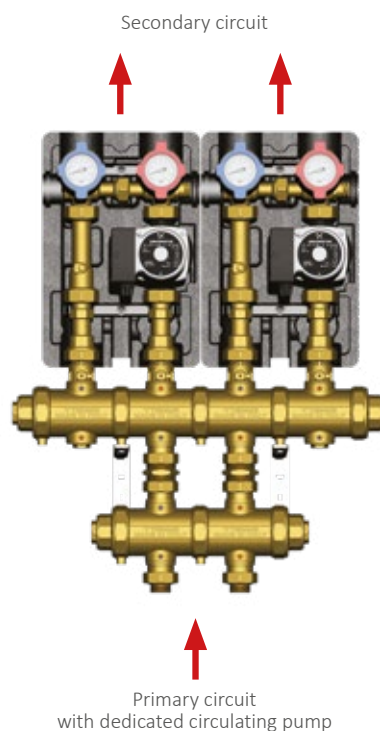
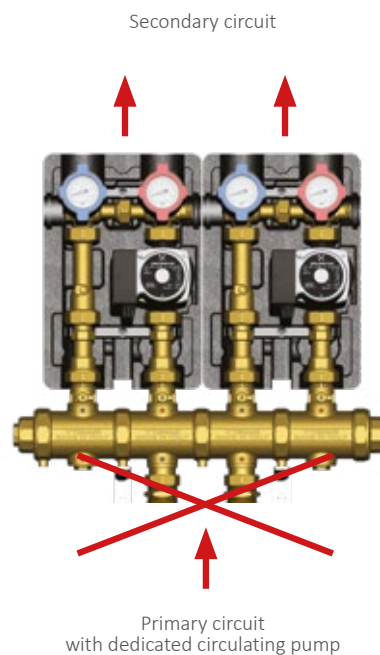
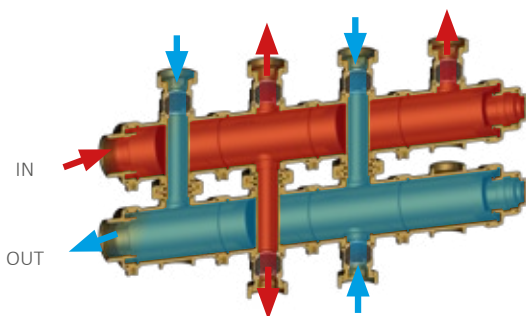

## ADVANTAGES / STRENGTHS

Tiemme brass manifolds 5538G and 5540G are designed to offer a number of advantages, including:



### Easy installation

Installation occurs with specific wall fixing brackets (included) on which the manifold is screwed



### Ball valve

Specifically made to optimize manifold installation and maintenance operations



### Compactness

Pumping and mixing stations (5535) can be installed upwards and downwards, for a higher compactness and flexibility



### Insulation

The product has a heating/cooling insulation shell



### Modularity

The manifold can be assembled as shown in the catalog or upon specific client requests

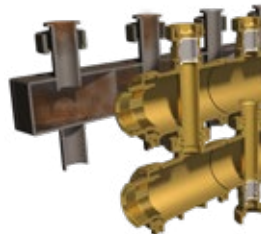

### Duration

The product is entirely made in brass, thus guaranteeing improved cleanness of the system and reducing the creation of rust. However, we recommend to use a bactericide/fungicide

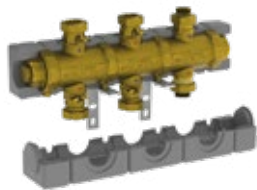

## 5538G2M3

Modular brass manifold for central heating system with ball valves, insulation shell and fixing brackets. 125 mm spacing, fittings with flat seat and 1"1/2 loose nut

Code	Section	No. circuits	Flow rate	Price €	Unit/Box
557 0368	2"1/2	2	2.2 (m³/h)		1/1
557 0483	2" 1/2	2	2.2 (m³/h)		1/1

### 5538G2M3

#### EXAMPLES OF ARRANGEMENTS

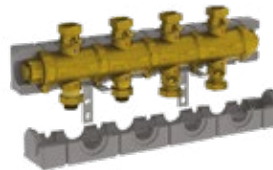
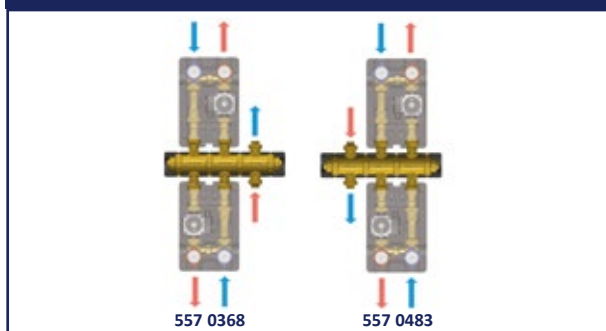

## 5538G3M4

Modular brass manifold for central heating system with ball valves, insulation shell and fixing brackets. 125 mm spacing, fittings with flat seat and 1"1/2 loose nut

Code	Section	No. circuits	Flow rate	Price €	Unit/Box
557 0370	2"1/2	3	2.2 (m³/h)		1/1
557 0486	2" 1/2	3	2.2 (m³/h)		1/1

### 5538G3M4

#### EXAMPLES OF ARRANGEMENTS

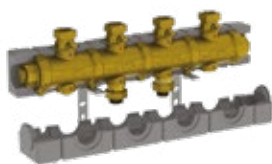
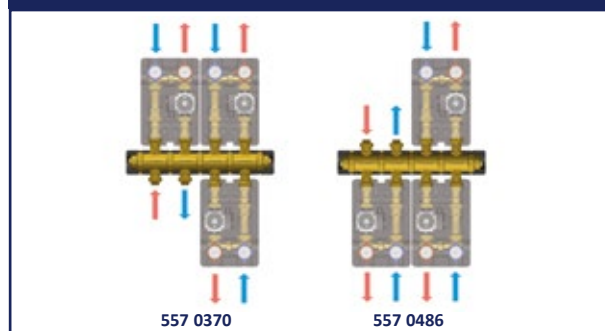

## 5538G2M4

Modular brass manifold for central heating system with ball valves, insulation shell and fixing brackets. 125 mm spacing, fittings with flat seat and 1"1/2 loose nut

Code	Section	No. circuits	Flow rate	Price €	Unit/Box
557 0369	2"1/2	2	2.2 (m³/h)		1/1
557 0484	2" 1/2	2	2.2 (m³/h)		1/1
557 0485	2" 1/2	2	2.2 (m³/h)		1/1

### 5538G2M4

#### EXAMPLES OF ARRANGEMENTS

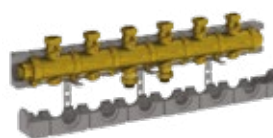
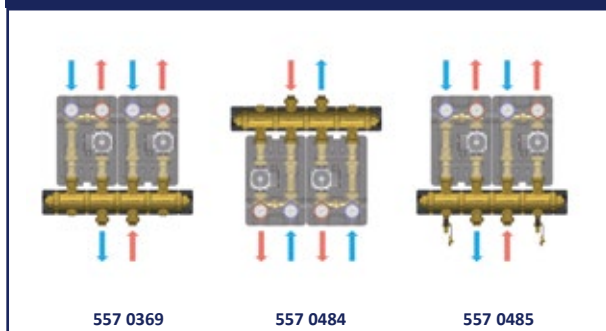

## 5538G3M6

Modular brass manifold for central heating system with ball valves, insulation shell and fixing brackets. 125 mm spacing, fittings with flat seat and 1"1/2 loose nut

Code	Section	No. circuits	Flow rate	Price €	Unit/Box
557 0371	2"1/2	3	2.2 (m³/h)		1/1
557 0487	2" 1/2	3	2.2 (m³/h)		1/1
557 0488	2" 1/2	3	2.2 (m³/h)		1/1

### 5538G3M6

#### EXAMPLES OF ARRANGEMENTS

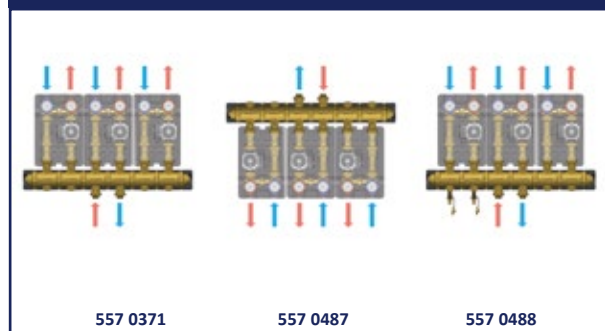



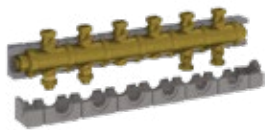

## 5538G4M6

Modular brass manifold for central heating system with ball valves, insulation shell and fixing brackets. 125mm spacing, fittings with flat seat and 1"1/2 loose nut

Code	Section	No. circuits	Flow rate	Price €	Unit/Box
557 0477	2"1/2	4	2.2 (m³/h)		1/1
557 0478	2" 1/2	4	2.2 (m³/h)		1/1
557 0479	2" 1/2	4	2.2 (m³/h)		1/1

### 5538G4M6

#### EXAMPLES OF ARRANGEMENTS

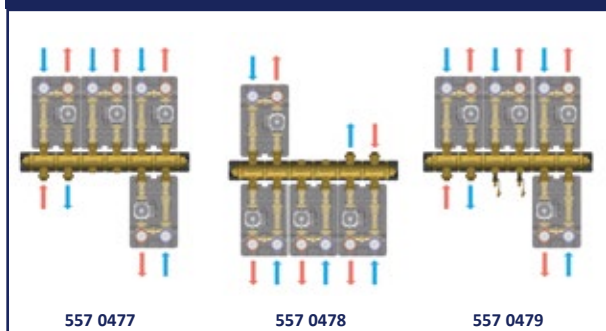

557 0477

557 0478

557 0479

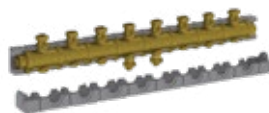

## 5538G4M8

Modular brass manifold for central heating system with ball valves, insulation shell and fixing brackets. 125 mm spacing, fittings with flat seat and 1"1/2 loose nut

Code	Section	No. circuits	Flow rate	Price €	Unit/Box
557 0480	2"1/2	4	2.2 (m³/h)		1/1
557 0481	2" 1/2	4	2.2 (m³/h)		1/1
557 0482	2" 1/2	4	2.2 (m³/h)		1/1

### 5538G4M8

#### EXAMPLES OF ARRANGEMENTS

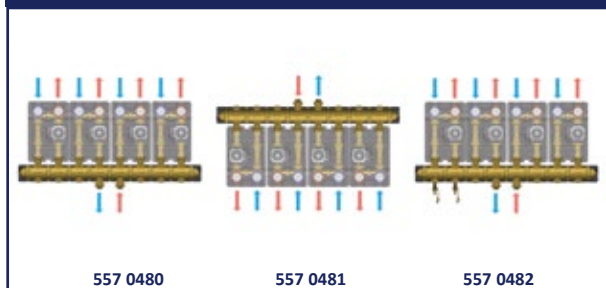

557 0480

557 0481

557 0482

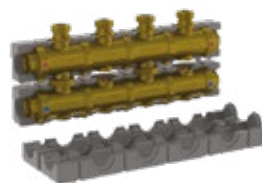

## 5540G2M4

Modular brass manifold for central heating system with ball valves, insulation shell and fixing brackets. 125 mm spacing, fittings with flat seat and 1"1/2 loose nut

Code	Section	No. circuits	Flow rate	Price €	Unit/Box
557 0372	2"1/2	2	6.5 (m³/h)		1/1
557 0489	2"1/2	2	6.5 (m³/h)		1/1
557 0490	2"1/2	2	6.5 (m³/h)		1/1

### 5540G2M4

#### EXAMPLES OF ARRANGEMENTS

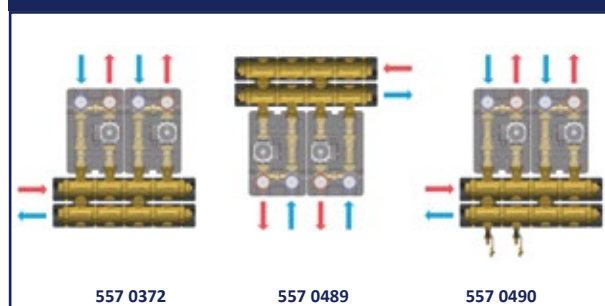

557 0372

557 0489

557 0490

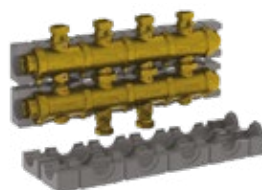

## 5540G3M4

Modular brass manifold for central heating system with ball valves, insulation shell and fixing brackets. 125 mm spacing, fittings with flat seat and 1"1/2 loose nut

Code	Section	No. circuits	Flow rate	Price €	Unit/Box
557 0373	2"1/2	3	6.5 (m³/h)		1/1
557 0491	2"1/2	3	6.5 (m³/h)		1/1
557 0492	2"1/2	3	6.5 (m³/h)		1/1

### 5540G3M4

#### EXAMPLES OF ARRANGEMENTS

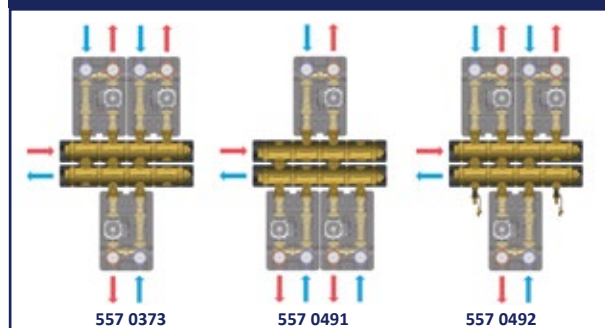

557 0373

557 0491

557 0492

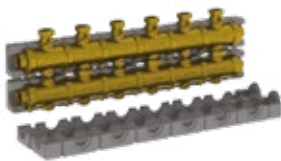

## 5540G3M6

Modular brass manifold for central heating system with ball valves, insulation shell and fixing brackets. 125 mm spacing, fittings with flat seat and 1"1/2 loose nut

Code	Section	No. circuits	Flow rate	Price €	Unit/Box
557 0374	2"1/2	3	6.5 (m³/h)		1/1
557 0493	2"1/2	3	6.5 (m³/h)		1/1
557 0494	2"1/2	3	6.5 (m³/h)		1/1

### 5540G3M6

#### EXAMPLES OF ARRANGEMENTS

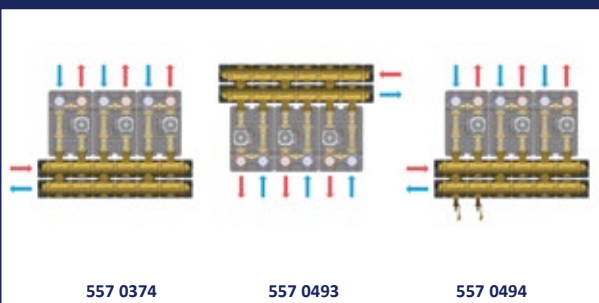

557 0374

557 0493

557 0494

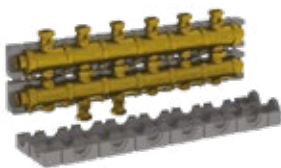

## 5540G4M6

Modular brass manifold for central heating system with ball valves, insulation shell and fixing brackets. 125 mm spacing, fittings with flat seat and 1"1/2 loose nut

Code	Section	No. circuits	Flow rate	Price €	Unit/Box
557 0375	2"1/2	4	6.5 (m³/h)		1/1
557 0495	2"1/2	4	6.5 (m³/h)		1/1
557 0496	2"1/2	4	6.5 (m³/h)		1/1

### 5540G4M6

#### EXAMPLES OF ARRANGEMENTS

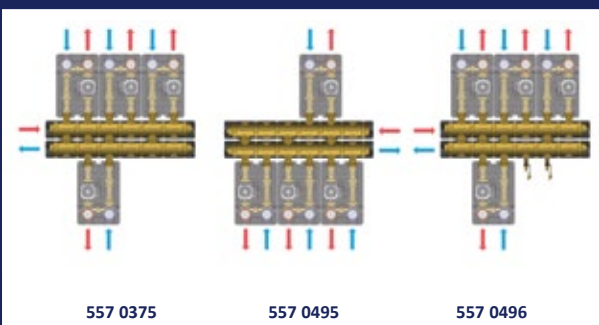

557 0375

557 0495

557 0496

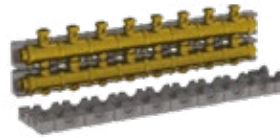

## 5540G4M8

Modular brass manifold for central heating system with ball valves, insulation shell and fixing brackets. 125 mm spacing, fittings with flat seat and 1"1/2 loose nut

Code	Section	No. circuits	Flow rate	Price €	Unit/Box
557 0376	2"1/2	4	6.5 (m³/h)		1/1
557 0497	2"1/2	4	6.5 (m³/h)		1/1
557 0498	2"1/2	4	6.5 (m³/h)		1/1

### 5540G4M8

#### EXAMPLES OF ARRANGEMENTS

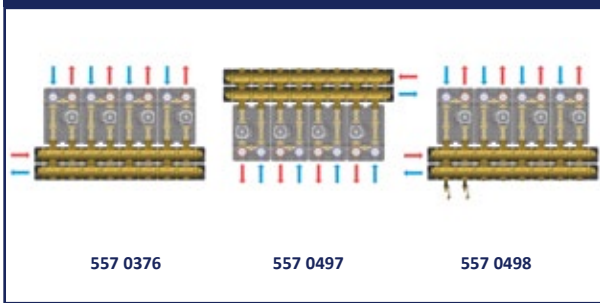

557 0376

557 0497

557 0498

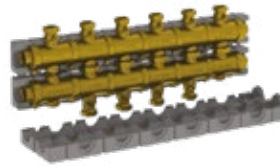

## 5540G5M6

Modular brass manifold for central heating system with ball valves, insulation shell and fixing brackets. 125 mm spacing, fittings with flat seat and 1"1/2 loose nut

Code	Section	No. circuits	Flow rate	Price €	Unit/Box
557 0377	2"1/2	5	6.5 (m³/h)		1/1
557 0499	2"1/2	5	6.5 (m³/h)		1/1
557 0500	2"1/2	5	6.5 (m³/h)		1/1

### 5540G5M6

#### EXAMPLES OF ARRANGEMENTS

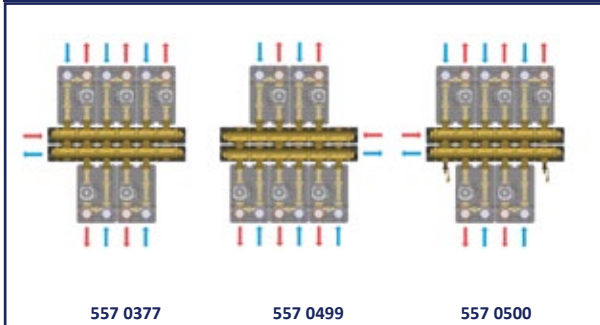

557 0377

557 0499

557 0500



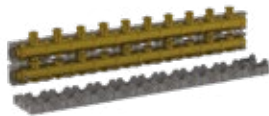

## 5540G5M10

Modular brass manifold for central heating system with ball valves, insulation shell and fixing brackets. 125 mm spacing, fittings with flat seat and 1"1/2 loose nut

Code	Section	No. circuits	Flow rate	Price €	Unit/Box
557 0476	2"1/2	5	6.5 (m³/h)		1/1
557 0501	2"1/2	5	6.5 (m³/h)		1/1
557 0502	2"1/2	5	6.5 (m³/h)		1/1

### 5540G5M10

#### EXAMPLES OF ARRANGEMENTS

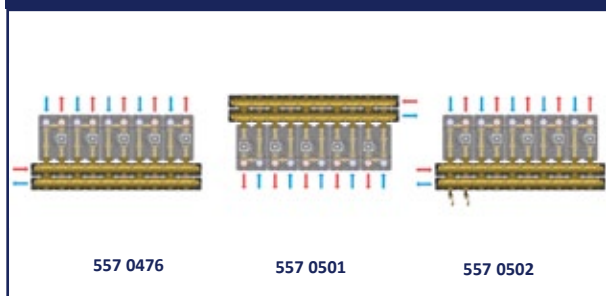

557 0476

557 0501

557 0502

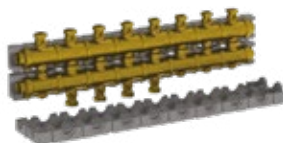

## 5540G6M8

Modular brass manifold for central heating system with ball valves, insulation shell and fixing brackets. 125 mm spacing, fittings with flat seat and 1"1/2 loose nut

Code	Section	No. circuits	Flow rate	Price €	Unit/Box
557 0378	2"1/2	6	6.5 (m³/h)		1/1
557 0503	2"1/2	6	6.5 (m³/h)		1/1
557 0504	2"1/2	6	6.5 (m³/h)		1/1

### 5540G6M8

#### EXAMPLES OF ARRANGEMENTS

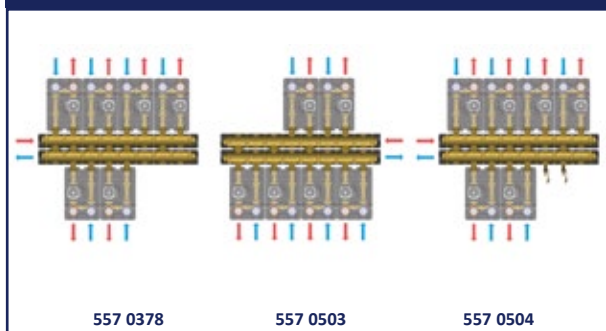

557 0378

557 0503

557 0504

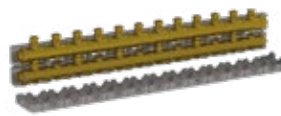

## 5540G6M12

Modular brass manifold for central heating system with ball valves, insulation shell and fixing brackets. 125 mm spacing, fittings with flat seat and 1"1/2 loose nut

Code	Section	No. circuits	Flow rate	Price €	Unit/Box
557 0505	2"1/2	6	6.5 (m³/h)		1/1
557 0506	2"1/2	6	6.5 (m³/h)		1/1
557 0507	2"1/2	6	6.5 (m³/h)		1/1

### 5540G6M12

#### EXAMPLES OF ARRANGEMENTS

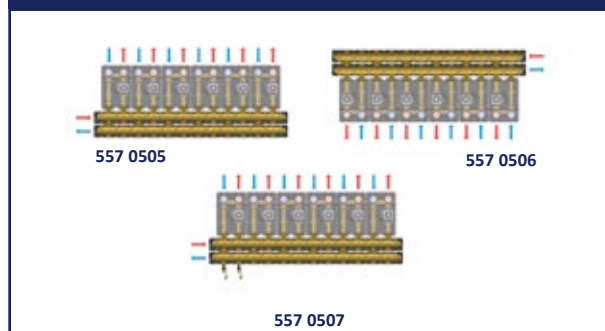

557 0505

557 0506

557 0507

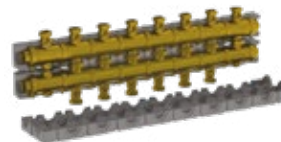

## 5540G7M8

Modular brass manifold for central heating system with ball valves, insulation shell and fixing brackets. 125 mm spacing, fittings with flat seat and 1"1/2 loose nut

Code	Section	No. circuits	Flow rate	Price €	Unit/Box
557 0508	2"1/2	7	6.5 (m³/h)		1/1
557 0509	2"1/2	7	6.5 (m³/h)		1/1
557 0510	2"1/2	7	6.5 (m³/h)		1/1

### 5540G7M8

#### EXAMPLES OF ARRANGEMENTS

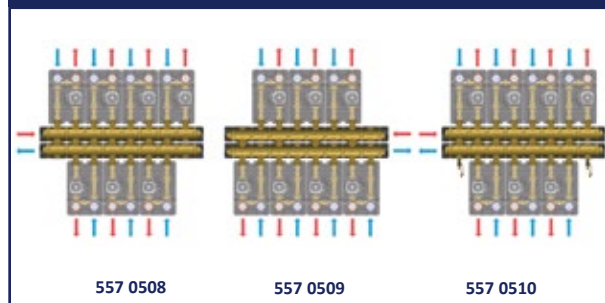

557 0508

557 0509

557 0510



## 5540G7M14

Modular brass manifold for central heating system with ball valves, insulation shell and fixing brackets. 125 mm spacing, fittings with flat seat and 1"1/2 loose nut

Code	Section	No. circuits	Flow rate	Price €	Unit/Box
557 0472	2"1/2	7	6.5 (m³/h)		1/1
557 0511	2"1/2	7	6.5 (m³/h)		1/1
557 0512	2"1/2	7	6.5 (m³/h)		1/1

### 5540G7M14

#### EXAMPLES OF ARRANGEMENTS

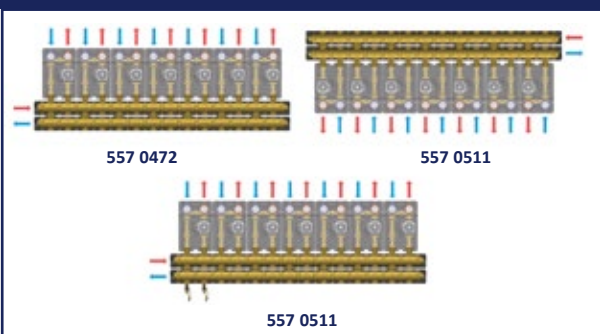

**IMPORTANT**  
specific arrangements are possible depending  
on CLIENT NEEDS



## 5538G - 5540G GUIDE TO FITTINGS

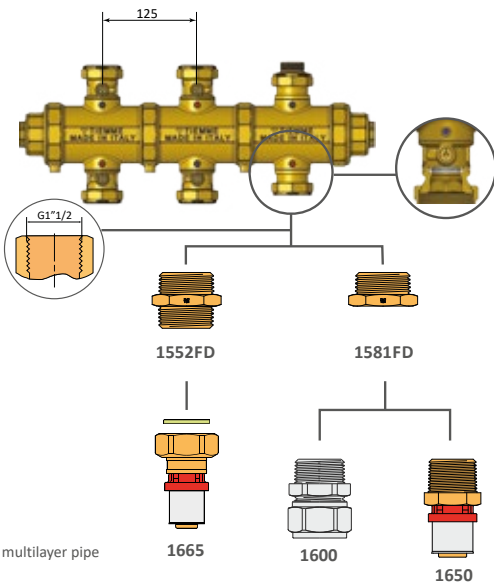
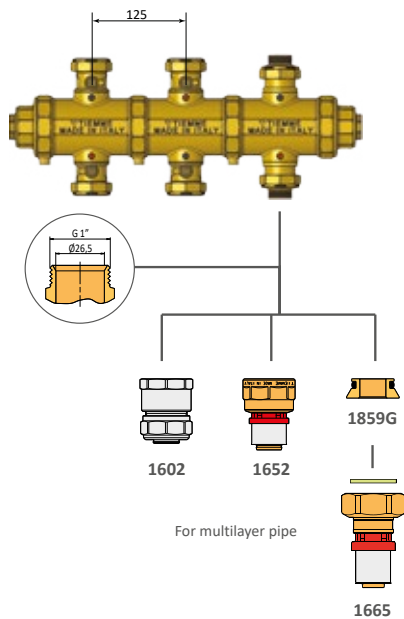

## 5540G GUIDE TO FITTINGS

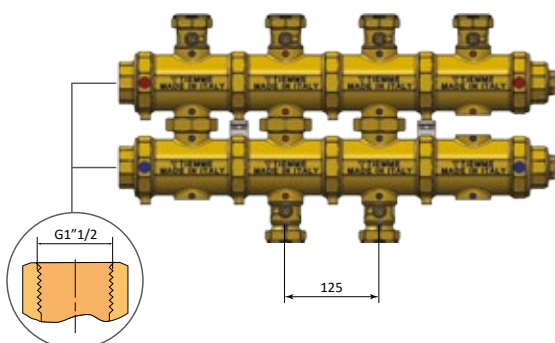

## 5538G - 5540G INSTALLATION

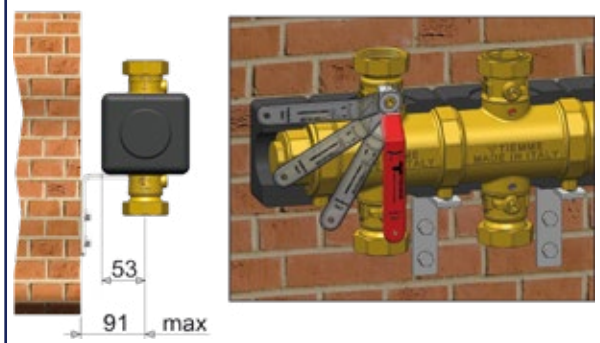

Wall installation is quick and easy, thanks to the specific adjustable brackets that can be screw-fixed onto the wall and to the manifold. Screw slots can be found directly on the manifold. With the ball valve installed on the manifold, it is possible to perform maintenance by shutting down the relevant line, without stopping the rest of the system, which can be kept operational.

## 5538G DIMENSIONS

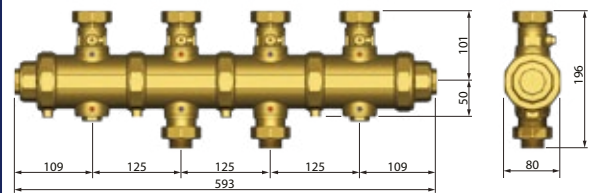

## 5540G DIMENSIONS

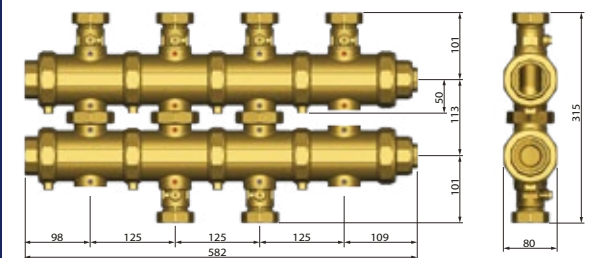



**1602**  
Female straight fitting for multilayer pipe

Code	Type	Price €	Unit/Box
160 0112	25 x 2.5 - 1"		5/50
160 0029	26 x 3.0 - 1"		5/100
160 0039	32 x 3.0 - 1"		5/50



**1652**  
Female straight fitting for multilayer pipe

Code	Type	Price €	Unit/Box
165 0268	25 x 2.5 - 1"		5/25
165 0053	26 x 3.0 - 1"		5/25
165 0050	32 x 3.0 - 1"		5/25



**1665**  
Straight fitting with swivel nut and flat-sealing for multilayer pipe

Code	Type	Price €	Unit/Box
165 0233	25 x 2.5 - 1"		2/50
165 0071	26 x 3.0 - 1"		2/50
165 0134	32 x 3.0 - 1"		2/100
165 0239	40 x 3.5 - 1"1/2		1/25

To be installed with 1859

To be installed with 1552FD



**1859**  
Adapter to turn 1" G connection into plain end

Code	Type	Price €	Unit/Box
144 0234	1" G		10/300



**1552FD**  
Male threaded nipple with flat seat

Code	Type	Price €	Unit/Box
471 0086	1"1/2 x 1"1/2		2/30



**1881**  
M/F reduction with O-ring for manifolds

Code	Type	Price €	Unit/Box
195 0066	1" 1/2 x 3/4"		5/70



**1828Z**  
Multi-screw bracket for central heating system manifolds

Code	Type	Price €	Unit/Box
179 0323	single		1/25



**2095R**  
Red steel flat handle

Code	Type	Price €	Unit/Box
209 0069	single		1/10



**2121CP**  
ISO 228 male-female ball valve with aluminum handle for manifolds and FLAT WASHER

Code	Type	Price €	Unit/Box
 212 0122	red handle 1"1/2		3/12

 212 0124	black handle 1"1/2		3/12
--	-----------------------	--	------



For pricelist scan the QR code

DN25 pumping station, art. 5535G, feeds high temperature circuits of heating systems, directly from manifold's connections, without changing the temperature of the incoming fluid. Two thermometers make it possible to check instantaneous flow and return temperature. A check valve is located on the return way that prevents the fluid from self-circulate when the circulating pump is off. The unit can be complemented by optional components, such as differential by-pass (art. 5535DIFF) and/or safety thermostat and pad (art. 2075KIT03).



1. Inflow ball valve with thermometer
2. Circulating pump (if equipped)
3. Inflow
4. Return
5. EPP insulation shell
6. Fixing brackets
7. Check valve
8. Return way
9. Return ball valve with thermometer

### PRODUCT RANGE



**5535G**  
Pumping station



#### TECHNICAL SPECIFICATIONS

- Body material: CW 617 N Brass
- Gasket material: EPDM
- Insulating shell material: EPP
- Size: DN25 (1")
- Connections distance between axes 125 mm:
  - Inlet: 1"1/2 male with plain end
  - Outgo: 1"1/2 male with plain end
- Max operating P: 8 bar
- Max operating T: 110°C

Code	Type	Price €	Unit/Box
316 0017	Without circulating pump		1/1
316 0043	Wilo PARA 25/7		1/1
316 0042	UPM3 HYBRID 25/70		1/1
316 0090	Wilo PARA 25/9		1/1
316 0018	Grundfos UPS 25-65		1/1

ErP READY

Available for non-UE countries

### DIAGRAM OF PRESSURE DROP CIRCULATING PUMP HEAD

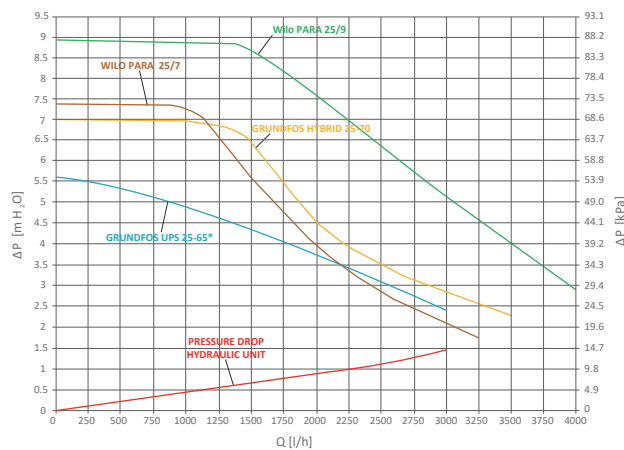

DN25 pumping station, art. 5535GPF, feeds high temperature circuits of heating systems, directly from manifold's connections, without changing the temperature of the incoming fluid. Two thermometers make it possible to check instantaneous flow and return temperature. A check valve is located on the return way that prevents the fluid from self-circulate when the circulating pump is off. Moreover, the mixing unit comes with a safety contact thermostat (intervention temperature: 55°C) to protect the system. The unit can be complemented by optional components, such as differential by-pass (art. 5535DIFF) and/or safety thermostat and pad (art. 2075KIT03).



1. Safety thermostat
2. Inflow ball valve with thermometer
3. Sensor-supporting well with nipple
4. Circulating pump (if equipped)
5. 3-way mixing valve with thermostatic head
6. Inflow
7. Return
8. EPP insulation shell
9. Fixing brackets
10. Check valve
11. Return way
12. Return ball valve with thermometer

### PRODUCT RANGE



### 5535GPF

Fixed point mixing unit



#### TECHNICAL SPECIFICATIONS

- Body material: CW 617 N Brass
- Gasket material: EPDM
- Insulating shell material: EPP
- Size: DN25 (1")
- Connections distance between axes 125 mm:
  - Inlet: 1"1/2 male with plain end
  - Outgo: 1"1/2 male with plain end
- Max operating P: 8 bar
- Max operating T: 110°C
- Temperature control: 20÷50°C
- Safety thermostat: 55°C

Code	Type	Price €	Unit/Box
316 0020	Without circulating pump		1/1
316 0046	Wilo PARA 25/7		1/1
316 0045	Grundfos UPM3 HYBRID 25/70		1/1
316 0091	Wilo PARA 25/9		1/1
316 0021	Grundfos UPS 25-65		1/1

ErP READY

Available for non-UE countries

### DIAGRAM OF PRESSURE DROP CIRCULATING PUMP HEAD

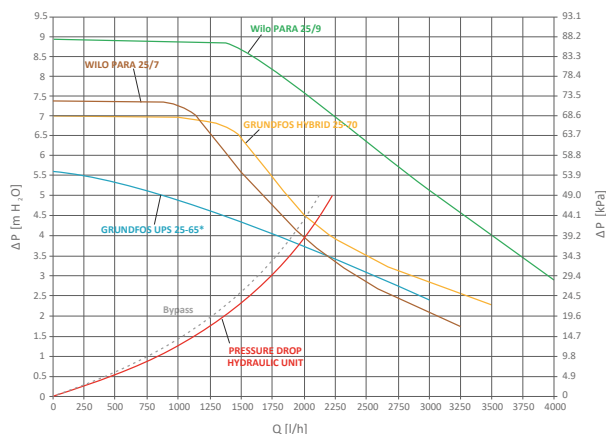



DN25 pumping station, art. 5535G3P, feeds high temperature circuits of heating systems, directly from manifold's connections, without changing the temperature of the incoming fluid. Two thermometers make it possible to check instantaneous flow and return temperature. A check valve is located on the return way that prevents the fluid from self-circulate when the circulating pump is off. The unit can be complemented by optional components, such as differential by-pass (art. 5535DIFF) and/or safety thermostat (art. 2075KIT03).



1. Inflow ball valve with thermometer
2. Ø 6mm sensor well with nipple
3. Circulating pump (if equipped)
4. 3-way mixing valve with servomotor
5. Inflow
6. Return
7. EPP insulation shell
8. Fixing brackets
9. Check valve
10. Return way
11. Return ball valve with thermometer

### PRODUCT RANGE



### 5535G3P

Mixing unit with servomotor



#### TECHNICAL SPECIFICATIONS

- Body material: CW 617 N Brass
- Gasket material: EPDM
- Insulating shell material: EPP
- Size: DN25 (1")
- Connections distance between axes 125 mm:
  - Inlet: 1"1/2 male with plain end
  - Outgo: 1"1/2 male with plain end
- Max operating P: 8 bar
- Max operating T: 110°C

#### SERVOMOTOR

- Power supply: 230 Vac SPDT control (3 ways)
- Rotation time: 120 secs (90° angle)
- Rated torque: 7 Nm

Code	Type	Price €	Unit/Box
316 0023	Without circulating pump		1/1
316 0049	Wilo PARA 25/7		1/1
316 0048	Grundfos UPM3 HYBRID 25/70		1/1
316 0092	Wilo PARA 25/9		1/1
316 0024	Grundfos UPS 25-65		1/1

ErP READY

Available for non-UE countries

### DIAGRAM OF PRESSURE DROP CIRCULATING PUMP HEAD

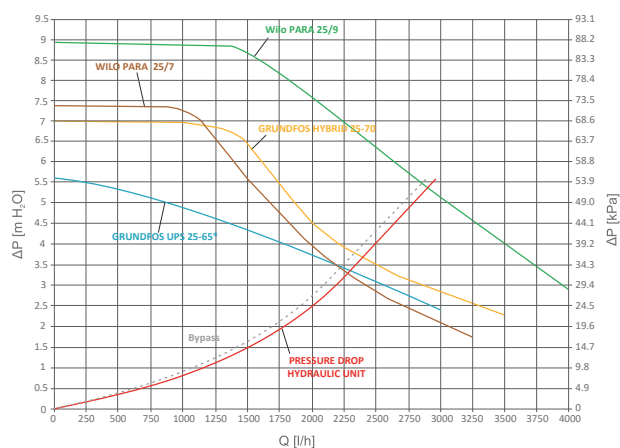

DN25 pumping station, art. 5536G, is a model of 5535G series designed to create cooling systems. To this purpose, the station has an EPP insulation shell that can reduce the creation of steam on metal surfaces. The station feeds circuits of heating/cooling systems from a manifold connections, without changing the temperature of the incoming fluid. Two thermometers allow to check instantaneous flow and return temperature. A check valve is located on the return way that prevents the fluid from self-circulate when the circulating pump is off. The unit can be complemented by optional components, such as differential by-pass (art. 5535DIFF) and/or safety thermostat and pad (art. 2075KIT03).



1. Inflow ball valve with thermometer
2. Circulating pump (if equipped)
3. Inflow
4. Return
5. Pex foam insulation shell
6. Fixing brackets
7. Check valve
8. Return way
9. Return ball valve with thermometer

### PRODUCT RANGE



### 5536G

Pumping station with insulation shell for cooling purposes



#### TECHNICAL SPECIFICATIONS

- Body material: CW 617 N Brass
- Gasket material: EPDM
- Insulating shell material: Foamed closed-cell PE-X
- Size: DN25 (1")
- Connections distance between axes 125 mm:
  - Inlet: 1"1/2 male with plain end
  - Outgo: 1"1/2 male with plain end
- Max operating P: 8 bar
- Max operating T: 110°C

Code	Type	Price €	Unit/Box
557 0383	Without circulating pump		1/1
557 0386	Wilo PARA 25/7		1/1
557 0559	Wilo PARA 25/9		1/1

ErP READY

### DIAGRAM OF PRESSURE DROP CIRCULATING PUMP HEAD

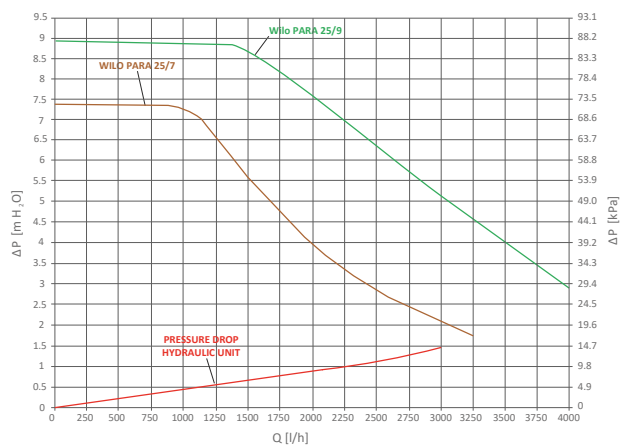

DN25 pumping station, art. 5536GS, is a model of 5535G3P series designed to create cooling systems. To this purpose, the unit has an EPP insulation shell that can reduce the creation of steam on metal surfaces. The unit feeds heating/cooling system circuits, directly from manifold connections, changing the temperature of the incoming fluid into the design value (thanks to the mixing valve controlled by a servomotor). Two thermometers make it possible to check instantaneous flow and return temperature. A check valve is located on the return way that prevents the fluid from self-circulate when the circulating pump is off. The unit can be complemented by optional components, such as differential by-pass (art. 5535DIFF) and/or safety thermostat (art. 2075KIT03).

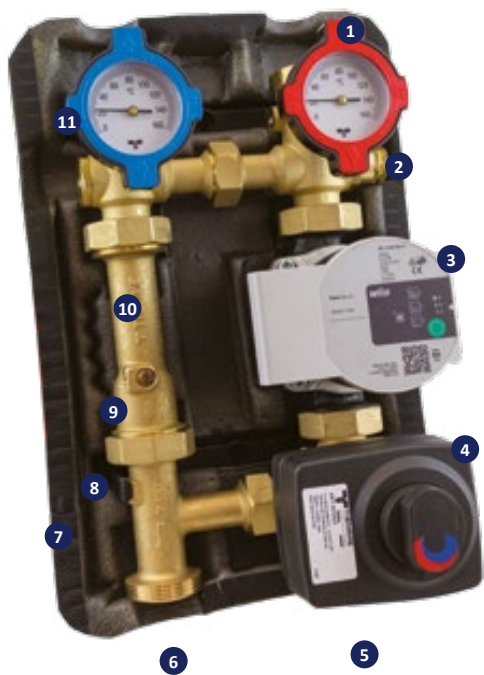

1. Inflow ball valve with thermometer
2. Ø 6mm sensor well with nipple
3. Circulating pump (if equipped)
4. 3-way mixing valve with servomotor
5. Inflow
6. Return
7. PEX foam insulation shell
8. Fixing brackets
9. Check valve
10. Return way
11. Return ball valve with thermometer

### PRODUCT RANGE



### 5536GS

Mixing unit with insulation shell with servomotor for cooling purposes



#### TECHNICAL SPECIFICATIONS

- Body material: CW 617 N Brass
- Gasket material: EPDM
- Insulating shell material: Foamed closed-cell PE-X
- Size: DN25 (1")
- Connections distance between axes 125 mm:
  - Inlet: 1"1/2 male with plain end
  - Outgo: 1"1/2 male with plain end
- Max operating P: 8 bar
- Max operating T: 110°C

#### SERVOMOTOR

- Power supply: 24 Vac (0-10Vdc control)
- Rotation time: 120 secs (90° angle)
- Rated torque: 7 Nm

Code	Type	Price €	Unit/Box
557 0388	Without circulating pump		1/1
557 0391	Wilo PARA 25/7		1/1
557 0560	Wilo PARA 25/9		1/1

ErP READY

### DIAGRAM OF PRESSURE DROP CIRCULATING PUMP HEAD

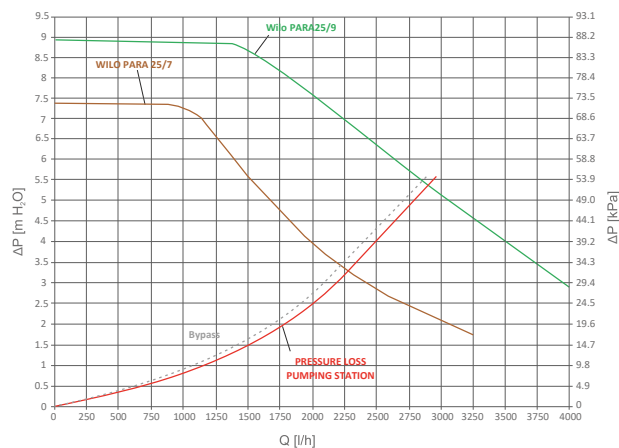

DN32 pumping station, art. 5534G, feeds high temperature circuits of heating systems, directly from manifold's connections, without changing the temperature of the incoming fluid. Two thermometers make it possible to check instantaneous flow and return temperature. A check valve is located on the return way that prevents the fluid from self-circulate when the circulating pump is off.

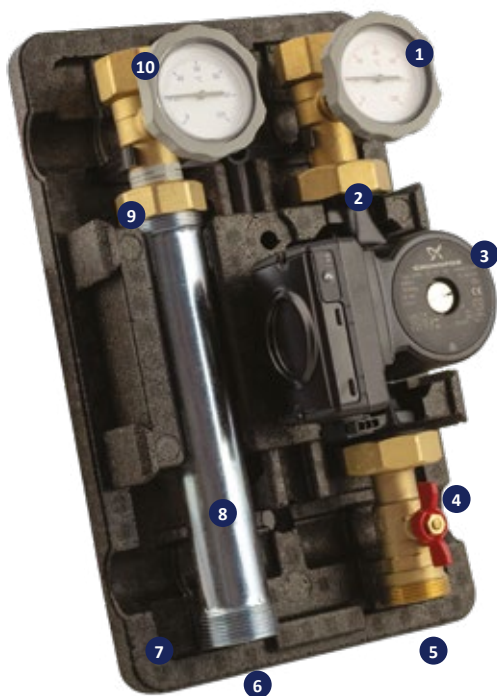

1. Inflow ball valve with thermometer
2. Check valve
3. Circulating pump (if equipped)
4. Pump fitting valve
5. Inflow
6. Return
7. Insulation shell
8. Return way
9. Check valve
10. Return ball valve with thermometer

### PRODUCT RANGE



### 5534G

Pumping station



#### TECHNICAL SPECIFICATIONS

- Body material: CW 617 N Brass
- Gasket material: EPDM
- Insulating shell material: EPP
- Size: DN32 (1"1/4)
- Connections distance between axes 125 mm:
  - Inlet: 1"1/2 male with plain end
  - Outlet: 1"1/4 female
- Max operating P: 8 bar
- Max operating T: 110°C

Code	Type	Price €	Unit/Box
316 0093	Without circulating pump		1/1
316 0095	Grundfos UPML 32-105 AUTO		1/1

ErP READY

### DIAGRAM OF PRESSURE DROP CIRCULATING PUMP HEAD

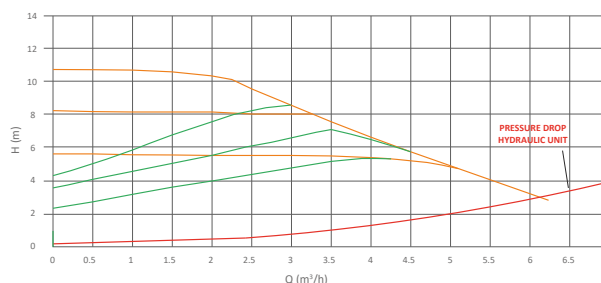

- Functioning with constant flow rate
- Functioning with variable flow rate
- Unit pressure drop



DN32 pumping station, art. 5534G3P, feeds high temperature circuits of heating systems, directly from manifold's connections, without changing the temperature of the incoming fluid (function guaranteed by the mixing valve controlled by a servomotor - accessory art. 9562SERV to be purchased separately). Two thermometers make it possible to check instantaneous flow and return temperature. A check valve is located on the return way that prevents the fluid from self-circulate when the circulating pump is off.

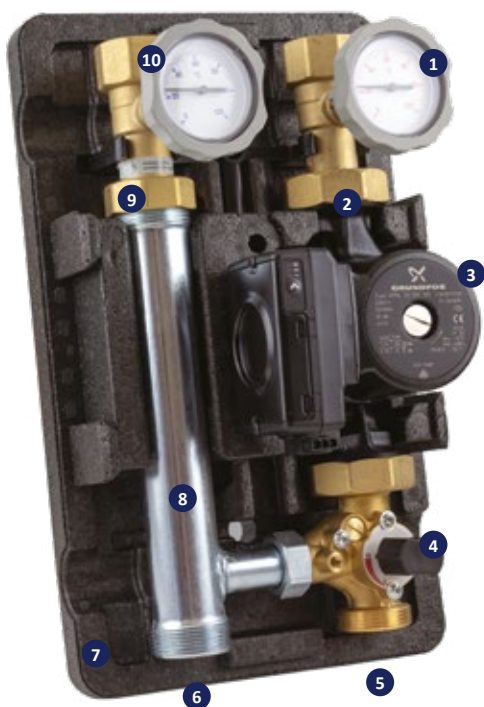

1. Inflow ball valve with thermometer
2. Check valve
3. Circulating pump (if equipped)
4. Mixing valve (optional servomotor)
5. Inflow
6. Return
7. Insulation shell
8. Return way
9. Check valve
10. Return ball valve with thermometer

### PRODUCT RANGE



### 5534G3P

Mixing unit for servomotor (not included)



#### TECHNICAL SPECIFICATIONS

- Body material: CW 617 N Brass
- Gasket material: EPDM
- Insulating shell material: EPP
- Size: DN 32
- Connections distance between axes 125 mm:
  - Inlet: 1"1/2 male with plain end
  - Outlet: 1"1/4 female
- Max operating P: 8 bar
- Max operating T: 110°C

 To be complemented with servomotor 9562SERV

Code	Type	Price €	Unit/Box
316 0097	Without circulating pump		1/1
316 0099	Grundfos UPML 32-105 AUTO		1/1

 ErP READY

### DIAGRAM OF PRESSURE DROP CIRCULATING PUMP HEAD

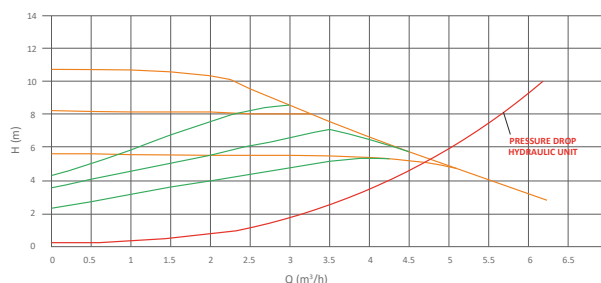

- Functioning with constant flow rate
- Functioning with variable flow rate
- Unit pressure drop



## 5535DIFF

Differential by-pass with 50-400 mbar settings. M25x1.5 fitting. (Can be used with any hydraulic power unit)

Code	Type	Price €	Unit/Box
316 0029	50-400 mbar		1/50



## 2075KIT03

Safety thermostat including a cable with straight connection

Code	Type	Price €	Unit/Box
557 0024	55 °C		1/1



## 3880GPF

Mixing valve for fixed point adjustment

**i** To be complemented with 9561KIT02 thermostatic kit

Code	Type	Price €	Unit/Box
316 0030	-		1/4



## 9561KIT02

Nipple + well + thermostatic head 20-50 °C kit with distance sensor. M30x1.5 fitting

**i** To be used with 5535GPF fixed point mixing unit

Code	Type	Price €	Unit/Box
450 0150	20-50 °C		1/10



## 3880GSM

Mixing valve for servomotor controller (not included)

**i** To be complemented with servomotor 9562SERV

Code	Type	Price €	Unit/Box
316 0031	-		1/4



## 9562SERV

Servomotor including a kit to connect to 3880GSM mixing valve

### TECHNICAL SPECIFICATIONS

- Body material: Self-extinguishing PA FV
- Rotation time: 120 secs
- Rotation angle: 90°
- Rated torque: 7 Nm
- Protection rating: IP 40
- Power supply:
  - 230 Vac SPDT (3 points)
  - 24 Vac SPDT (3 points)
  - 24 Vac (0 - 10 Vdc)

Code	Type	Price €	Unit/Box
557 0023	230 Vac SPDT (3 points)		1/8
557 0306	24 Vac SPDT (3 points)		1/8
557 0307	24 Vac 0-10 Vdc		1/8



## 4745MANOP

Handle with immersion thermometer for hydraulic power units

Code	Type	Price €	Unit/Box
470 0183	Blue		10/40
470 0184	Red		10/40



## 5537KIT

Nipple + well kit for Ø6 mm sensor. M25x1.5 fitting

**i** To be used with 5535G3P mixing unit with servomotor

Code	Type	Price €	Unit/Box
557 0022	-		1/25





## 1665

Straight fitting with swivel nut and flat-sealing for multilayer pipe

Code	Type	Price €	Unit/Box
165 0240	32 x 3.0 - 1"1/2		1/50
165 0239	40 x 3.5 - 1"1/2		1/25



## 1557SET

Brass female pump connection kit with flat end

**i** The kit includes: 2 tails, 2 nuts and 2 gaskets

Code	Type	Loose nut	Price €	Unit/Box
150 0355	1"	1"1/2		1/20



## 3890PW2

Wilo PARA 25/7 high efficiency pump with 130 mm spacing

**+** HIGH-EFFICIENCY PUMP

Code	Type	Price €	Unit/Box
450 0358	Wilo PARA 25/7		1/1



## 3890PW5

Wilo PARA 25/9 high efficiency pump with 130 mm spacing. 1"1/2 fitting on cast iron body

**+** HIGH-EFFICIENCY PUMP

Code	Type	Price €	Unit/Box
450 0557	Wilo PARA 25/9		1/1



## 3890PV

Grundfos UPSM3 HYBRID 25/70 high efficiency pump with 130 mm spacing. 1"1/2 fitting on cast iron body

**+** HIGH-EFFICIENCY PUMP

Code	Type	Price €	Unit/Box
450 0091	Grundfos UPM3 HYBRID 25/70		1/1



## 3890P

Grundfos UPS 25-55 3 speed pump with 130 mm spacing. 1"1/2 fitting on cast iron body

Code	Type	Price €	Unit/Box
450 0033	Grundfos UPS 25-55		1/1

Available for non-UE countries



## 3890PU

High-efficiency pump. 2" fittings with 180 mm spacing

**+** HIGH-EFFICIENCY PUMP

Code	Type	Price €	Unit/Box
450 0637	Grundfos UPML 32-105		1/1

### SINGLE-FAMILY SYSTEM

Single-family radiant heating/cooling system with boiler and heat pump. Tiemme brass manifold, **art. 5538G2M4**, with Tiemme hydraulic separator, **art. 7166**.

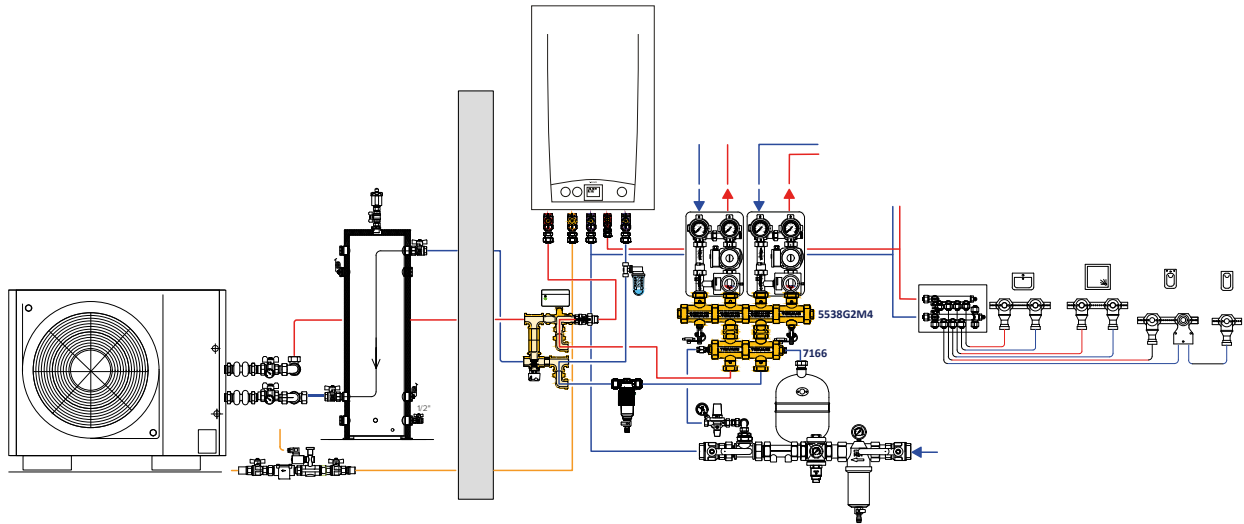

### MULTI-FAMILY SYSTEM

Multi-family system with cascade heating generators Tiemme brass manifold, **art. 5540G6M12**, and Tiemme hydraulic separator, **art. 3144**, including drain cock and deaerator.

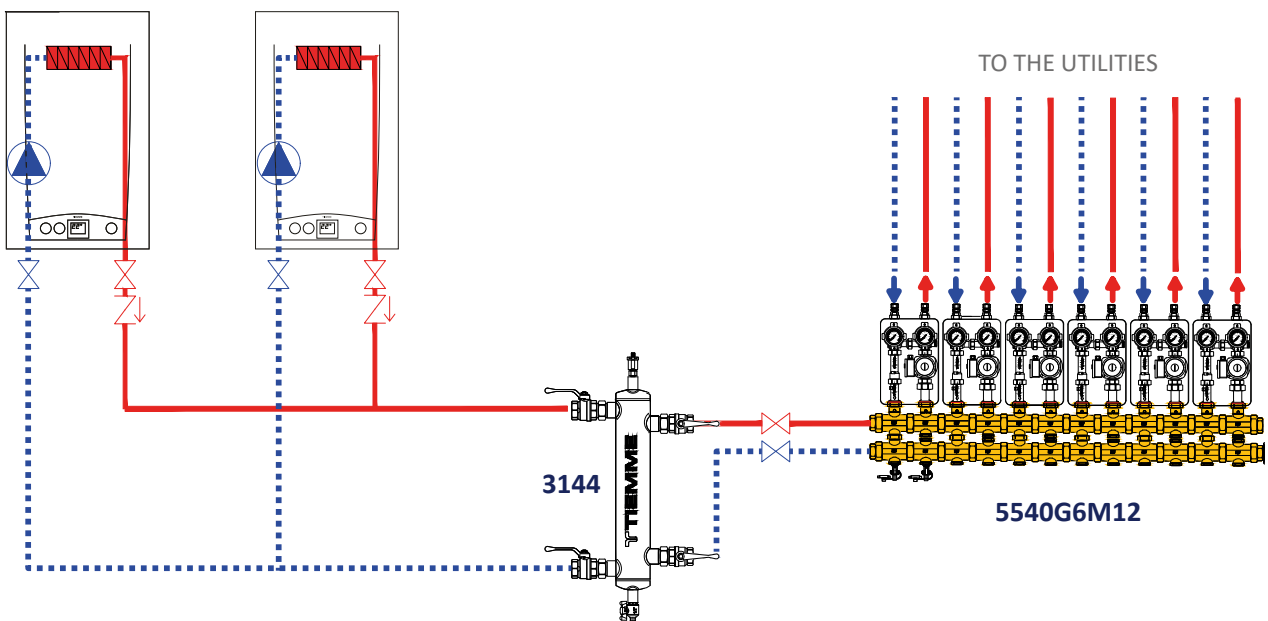



# 06

## CLIMAV 2.0 BUILDING MANAGEMENT THERMOREGULATION

**06A** Improved thermoregulation with  
Climav 2.0 Building Management 160

---

**06B** Climav 2.0 Building Management modules



172

---

**06C** Temperature and humidity probes



179

---

# 06A IMPROVED THERMOREGULATION WITH CLIMAV 2.0 BUILDING MANAGEMENT

## INTRODUCTION

Climav 2.0 Building Management system is designed for any system regardless of its type and size, both for heating and cooling, or with regulation of different flow temperatures.

Temperature and humidity room probes communicate with the central system and can detect at any time different climate changes, thus self-regulating according to the temperature required.

### HOW IT WORKS

Climav 2.0 Building Management thermoregulation system is ideal to manage radiant floor and/or ceiling systems operating both in summer and winter, thus guaranteeing the comfort required and significant energy savings.

High modularity enables the regulation system to control different types of building, to small size residential ones to commercial and service-providing buildings, integrating necessary energy supply with renewable energy sources and controlling different room variables (temperature, relative humidity, etc.) by means of controlled mechanic ventilation.

TIEMME thermoregulation system has a series of peculiarities:

- **Easy to install:** connections of system components via bus are easy and do not depend on specific logic sequences. This results in a significant reduction of wiring time.
- **Modularity:** the regulation system can be expanded, thus adjusting to specific system requirements and to potential updated configurations in the future.
- **Flexibility:** different types of regulation are available, thus allowing to use the system in a wide range of buildings and guaranteeing safety in the management of different system aspects.
- **Communication:** WEB management enables remote use of the system and remote control, diagnostics, and data storage both by the user and the maintainer.
- **Visibility:** the system comes with a wide range of temperature/humidity probes with built-in or external installation, all communicating with different room thermostats.





## WHAT MAKES IT UNIQUE

### USER-FRIENDLY TOUCH INTERFACE

The bright color display allows to manage in real time all the system functions for each room. Lightly touch the touchscreen to view the intuitive graphic interface and start interacting with the system.

### TIME PROGRAMMING

The system perfectly integrates with your personal habits. The program of each room can be tailored to manage parameters and time slots.

### MODULARITY

The system perfectly adjust to a house's specific requirements, with the possibility of future expansions if new configurations are developed. Climav 2.0 Building Management is the first system communicating with KNX and MODBUS protocol through an interface.



### UNIQUE

Climav 2.0 Building Management has unprecedented quality compared with traditional regulations, like fixed point or traditional climate regulations. Climav 2.0 Building Management allows to control any climate aspect: heating, cooling, humidity management, ventilation control for air exchange. A superior comfort rooted in a correct use of energy and in the optimization of energetic and economic consumptions.

### CONSUMPTION MONITORING

It allows you to constantly track the energy consumption of the generators installed, allowing you to identify any critical factors and allow for improvement.

# 06A IMPROVED THERMOREGULATION WITH CLIMAV 2.0 BUILDING MANAGEMENT

AN APP TO MANAGE YOUR HOUSE

View and control in real time your domestic well being in each room, while driving your car or working at the office, you only need to touch your smartphone's display. Tiemme made this possible with an app developed for their Climav 2.0 Building Management regulation system.



For pricelist scan the QR code

# 06A IMPROVED THERMOREGULATION WITH CLIMAV 2.0 BUILDING MANAGEMENT

AN APP TO MANAGE YOUR HOUSE



ZONE 3  19.0 °C

ZONE 4  18.0 °C

APP AVAILABLE FOR BOTH ANDROID AND IOS



# 06A IMPROVED THERMOREGULATION WITH CLIMAV 2.0 BUILDING MANAGEMENT

## EXAMPLES OF ARRANGEMENTS

### BASE SYSTEM

Example of small house managed with a climate compensation heating system.

BASE SYSTEM is made with a climatic RC\_SA control, art. 5530M5 - 5530M6, and allows to manage:

- 1 mixing unit with analog or 3-point servomotor;
- compensation of flow temperature with external and internal probes;
- 1 thermal zone (room temperature probe).



1. Boiler
2. External probe
3. Radiant system collector equipped with mixing unit
4. Room temperature probe

### SYSTEM COMPONENTS



**RC\_SA**  
**5530M5**  
**5530M6**  
Climate control



**T\_EXT**  
**5530E**  
External probe



**5530P**  
Fluid temperature probe

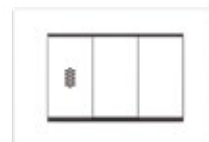

**T\_P**  
**5530I9**  
Room temperature probe



### EVO SYSTEM 1

Example of a heated flat.

EVO SYSTEM 1, created with a MHC BASIC master module, art. 5530M8, allows to manage:

- 1 heat generator for heating alone;
- 1 distribution unit with mixing function;
- 6 thermal zones (room temperature probes);
- External probe;
- Inflow probe.



1. Radiant system collector equipped with mixing unit
2. Room temperature probe
3. External probe
4. Boiler

### SYSTEM COMPONENTS



**MHC BASIC**  
**5530M8**  
Master module



**T\_EXT**  
**5530E**  
External probe



**5530P**  
Fluid temperature probe

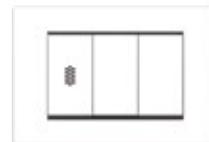

**T\_P**  
**5530I9**  
Room temperature probe



**CLIMAV 6000**  
**5530V**  
Viewer



**MPW22COM**  
**5530M2COM**  
Power supply

 Module connection is made with a RS485 serial line.

# 06A IMPROVED THERMOREGULATION WITH CLIMAV 2.0 BUILDING MANAGEMENT

## EXAMPLES OF ARRANGEMENTS

### EVO SYSTEM 2

Example of a flat heated/cooled with climate compensation and humidity control using a dehumidifier. EVO SYSTEM 2, created with a MHC BASIC master module, art. 5530M1, allows to manage:

- 2 heat generators for heating or cooling alone;
- Distribution units with mixing function;
- 8 thermal zones (room temperature/humidity probes);
- External probe.
- Inflow probe.



1. Radiant system collector equipped with mixing unit
2. Room temperature and humidity probe
3. Dehumidifier
4. External probe
5. Boiler + heat pump
6. Room temperature probe

### SYSTEM COMPONENTS



**MHC**  
**5530M1**  
Master module



**T\_EXT**  
**5530E**  
External probe



**5530P**  
Fluid temperature probe

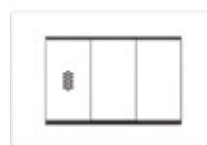

**T\_P - TH\_P**  
**5530I9 - 5530I10**  
Room temperature and room temperature/humidity probes



**CLIMAV 6000**  
**5530V**  
Viewer



**MPW22COM**  
**5530M2COM**  
Power supply

Module connection is made with a RS485 serial line.





# 06A IMPROVED THERMOREGULATION WITH CLIMAV 2.0 BUILDING MANAGEMENT

## EXAMPLES OF ARRANGEMENTS

### EVO SYSTEM 3

Example of a flat heated/cooled with climate compensation, humidity control using a dehumidifier and controlled mechanical ventilation (CMV).

EVO SYSTEM 3, created with a MHC BASIC master module, art. 5530M1, allows to manage:

- 2 heat generators for heating or cooling alone;
- Distribution units with mixing function;
- 8 thermal zones (room temperature/humidity probes);
- External probe;
- Inflow probe;
- Slave SFDC module management (CMV control).



1. Radiant system collector equipped with mixing unit
2. Room temperature and humidity probe
3. Dehumidifier
4. CMV (SFDC module)
5. External probe
6. Boiler + heat pump
7. Room temperature probe

### SYSTEM COMPONENTS



**MHC**  
**5530M1**  
Master module



**SFDC**  
**5530S7**  
CMV managed slave module



**T\_EXT**  
**5530E**  
External probe



**5530P**  
Fluid temperature probe

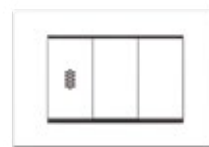

**T\_P - TH\_P**  
**5530I9 - 5530I10**  
Room temperature and room temperature/humidity probes



**CLIMAV 6000**  
**5530V**  
Viewer



**MPW22COM**  
**5530M2COM**  
Power supply

Module connection is made with a RS485 serial line.

## CLIMAV 6000 - VISOR



### 5530V

CLIMAV 6000 is a capacitive touchscreen visor bringing true innovation in building management.

When connected to the master unit (MHC or MHC BASIC) allows the user to completely control the entire thermoregulation system. Linear minimalist design makes it suitable for any residential or working environment.

The 4:3 4.1" display allows to intuitively benefit from all the potential of a smart system. CLIMAV 6000 comes with an internal watch and a USB port for software updates. Available in white or black.

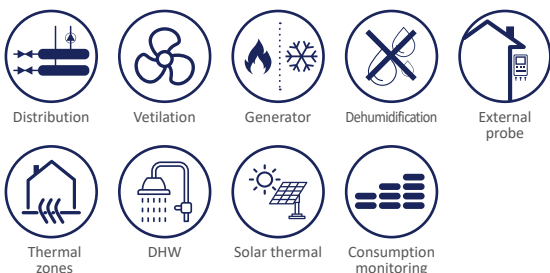

#### TECHNICAL SPECIFICATIONS

- Voltage: 12-24 Vac / Vdc
- Power consumption: 4 VA
- Internal fuse: 5 A delayed
- Protection category: IP40
- Protection class: II
- Operating room temperature: 0 ÷ 40 °C
- Relative humidity of operating environment: Up to 85 % at T=25 °C
- Storage temperature: 0 ÷ 60 °C
- Relative storage humidity: no condensation
- Shell: Plastic ABS
- Installation: on the wall
- Display: graphic color TFT 4.1" display
- Programming: touchscreen
- Size (LxHxP): 122 x 88 x 18 mm

Code	Color	Price €	Unit/Box
555 0101	□ White		1/4
555 0336	■ Black		1/4

## MHC BASIC - MASTER MODULE



### 5530M8

MHC BASIC master module for system control. The module can control 6 thermal zones (Temperature and Temperature/Humidity), 1 energy source, 1 mixing unit with analog actuator and, optionally, a dehumidifier (replacing a thermal zone).

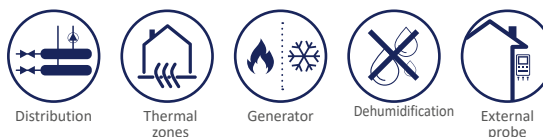

#### TECHNICAL SPECIFICATIONS

- Voltage: 12-24 Vac / Vdc
- Power consumption: 7 VA
- Relay capacity: 6 A 250Vac
- Protection category: IP40
- Protection class: II
- Operating room temperature: 0 ÷ 40 °C
- Relative humidity of operating environment: Up to 85 % at T=25 °C
- Storage temperature: 0 ÷ 60 °C
- Relative storage humidity: no condensation
- Shell: Plastic ABS
- Installation: on DIN track (6 modules)
- Inlets:
  - 6 inlets for T and T+H room probes
  - 2 inlets (NTC) for external probe (T\_EXT) and inflow probe (5530P)
- Outgoes:
  - 6 relays (1 per zone) to manage electro-thermal servo controls (a servo control can be replaced by a dehumidifier).
  - 1 0-10 V or 4-20 mA control (software-setting) to control the mixing system.
  - 1 relay to switch circulating pumps on/off
  - 1 relay to switch the power generator on/off (heating only or cooling only)
- Size (LxHxP): 105 x 95 x 60 mm (6 DIN modules)

**i** To connect to the CLIMAV 6000 visor.

Code	Type	Price €	Unit/Box
555 0344	-		1/4



## MHC - MASTER MODULE



### 5530M1

Master module to use in Climav 2.0 Building Management thermoregulating system with CLIMAV 6000 visor. MHC module is one of the main components of the system and has a small view-only display and three led lamps signaling the operating status of the device. This module allows to manage 8 thermal zones/dehumidifiers, 4 distribution/mixing units with analog actuator and 2 power generators (heating only or cooling only). It is also possible to extend functions by connecting further slave modules via bus.



Consumption monitoring

#### TECHNICAL SPECIFICATIONS

- Inlet voltage: 12-24 Vac / Vdc
- Power consumption: 7 VA
- Relay capacity: 6 A 250Vac
- Protection category: IP40
- Protection class: II
- Operating room temperature: 0 ÷ 40 °C
- Relative humidity of operating environment: Up to 85 % at T=25 °C
- Storage temperature: 0 ÷ 60 °C
- Relative storage humidity: no condensation
- Shell: Plastic ABS
- Installation: on DIN track (6 modules)
- Display: Graphic 16x2 line display, 3 LEDs (red, yellow, green), 3 buttons
- Inlets:
  - 8 inlets for T and T+H room probes
  - 2 inlets (NTC) for external probe (T\_EXT) and inflow probe (5530P)
  - 1 digital inlet for switching season (summer/winter)
  - 3 impulsive inlets for consumption monitoring
- Outgoes:
  - 8 relays (1 per zone) to handle electro-thermal servo controllers
  - 4 0-10 V or 4-20 mA controls (software-setting) to control the mixing system
  - 4 relay to switch circulating pumps on/off
  - 2 relays to switch power generators on/off (heating only, cooling only or both)
  - 1 relay to signal season change
- Size (LxHxP): 105 x 95 x 60 mm (6 DIN modules)

Code	Type	Price €	Unit/Box
555 0106	-		1/4

## SFDC - SLAVE MODULE



### 5530S7

SFDC slave module allows two control 2 fail coil units (without electronic elements) or a complete Controlled Mechanical Ventilation (CMV) unit (dehumidification, renewal, integration).



#### TECHNICAL SPECIFICATIONS

- Inlet voltage: 12-24 Vac / Vdc
- Power consumption: 7 VA
- Relay capacity: 6 A 250Vac
- Protection category: IP40
- Protection class: II
- Operating room temperature: 0 ÷ 40 °C
- Relative humidity of operating environment: Up to 85 % at T=25 °C
- Storage temperature: 0 ÷ 60 °C
- Relative storage humidity: no condensation
- Shell: Plastic ABS
- Installation: on DIN track (6 modules)
- Inlets:
  - 1 request of bathroom renovation (free contact)
  - 1 unit anomaly (free contact)
- Outgoes:
  - 1 relay to switch summer/winter
  - 1 relay to request dehumidification
  - 1 relay to request renovation
  - 1 relay to request bathroom renovation (free contact)
  - 1 relay to turn unit on/off
  - 1 relay to request integration
  - 1 relay to request ventilation
  - 1 modulation of battery valve
- Size (LxHxP): 105 x 95 x 60 mm (6 DIN modules)

To manage CMV

Code	Type	Price €	Unit/Box
555 0119	-		1/4

## SZC - SLAVE MODULE



### 5530S4

SZC slave module expands and integrate basic functions of MHC master module, allowing to manage 8 further thermal zones. Specifically, it enables the connection of 8 further Temperature and/or Temperature/humidity probes, and the control of electro-thermal servo controllers.



Thermal zones



Dehumidification

#### TECHNICAL SPECIFICATIONS

- Inlet voltage: 12-24 Vac / Vdc
- Power consumption: 7 VA
- Relay capacity: 6 A 250Vac
- Protection category: IP40
- Protection class: II
- Operating room temperature: 0 ÷ 40 °C
- Relative humidity of operating environment: Up to 85 % at T=25 °C
- Storage temperature: 0 ÷ 60 °C
- Relative storage humidity: no condensation
- Shell: Plastic ABS
- Installation: on DIN track (6 modules)
- 8 inlets for T and T+H room probes
- 8 relay outlets (1 per zone) to handle electro-thermal servo controllers
- Size (LxHxP): 105 x 95 x 60 mm (6 DIN modules)

**i** For expansion of 8 thermal zones

Code	Type	Price €	Unit/Box
555 0116	-		1/4

## SBC - SLAVE MODULE



### 5530S5

SBC slave module expands and integrate basic functions of MHC master module, allowing to manage 3 further heating/cooling generators. Specifically, it can control their activation/deactivation, operation priority, set-point and alarms.



Generator

#### TECHNICAL SPECIFICATIONS

- Inlet voltage: 12-24 Vac / Vdc
- Power consumption: 7 VA
- Relay capacity: 6 A 250Vac
- Protection category: IP40
- Protection class: II
- Operating room temperature: 0 ÷ 40 °C
- Relative humidity of operating environment: Up to 85 % at T=25 °C
- Storage temperature: 0 ÷ 60 °C
- Relative storage humidity: no condensation
- Shell: Plastic ABS
- Installation: on DIN track (6 modules)
- Inlets
  - 3 inlets to activate generators
  - 3 generator alarms (free contact)
  - 6 inlets (NTC) for inflow/return generator probes
- Outgoes:
  - 3 relays to control generator activation
  - 3 relays for generator switchover
  - 2 inlets to activate generator setpoints
- Size (LxHxP): 105 x 95 x 60 mm (6 DIN modules)

**i** To manage up to 3 heating/cooling generators

Code	Type	Price €	Unit/Box
555 0117	-		1/4



## SSCC - SLAVE MODULE



### 5530S6

SSCC slave module expands and integrate basic functions of MHC master module, allowing to manage the solar thermal system. Specifically, it allows to program 8 different patterns, manage system protections, accumulations and pumps.



Solar thermal

#### TECHNICAL SPECIFICATIONS

- Inlet voltage: 12-24 Vac / Vdc
- Power consumption: 7 VA
- Relay capacity: 6 A 250Vac
- Protection category: IP40
- Protection class: II
- Operating room temperature: 0 ÷ 40 °C
- Relative humidity of operating environment: Up to 85 % at T=25 °C
- Storage temperature: 0 ÷ 60 °C
- Relative storage humidity: no condensation
- Shell: Plastic ABS
- Installation: on DIN track (6 modules)
- Inlets:
  - 4 endswitches for motorized valves
  - 2 thermal protection inlets for solar thermal pumps
  - 9 inlets (PT1000) for temperature probes
- Outgoes:
  - 4 relays to control motorized valves
  - 2 relays to control solar pumps
  - 2 analog controllers for solar pumps
- Size (LxHxP): 105 x 95 x 60 mm (6 DIN modules)

**i** To manage the solar thermal system

Code	Type	Price €	Unit/Box
555 0118	-		1/4

## SMC - SLAVE MODULE



### 5530S1

SMC slave module expands and integrate basic functions of MHC master module, allowing to manage 4 analog mixing valves. Specifically, it manages their (0-10 Vdc or 4-20 mA) control, setpoint temperatures and relevant pumps.



Distribution

#### TECHNICAL SPECIFICATIONS

- Inlet voltage: 12-24 Vac / Vdc
- Power consumption: 7 VA
- Relay capacity: 6 A 250Vac
- Protection category: IP40
- Protection class: II
- Operating room temperature: 0 ÷ 40 °C
- Relative humidity of operating environment: Up to 85 % at T=25 °C
- Storage temperature: 0 ÷ 60 °C
- Relative storage humidity: no condensation
- Shell: Plastic ABS
- Installation: on DIN track (6 modules)
- Inlets:
  - 4 inlets for circulation pumps (free contact)
  - 4 inlets for flow temperature probes (NTC)
- Outgoes:
  - 4 relays to turn circulation pumps on/off
  - 4 analog controllers (0-10 V or 4-24 mA) to modulate mixing valves
- Size (LxHxP): 105 x 95 x 60 mm (6 DIN modules)

**i** As an expansion, 4 mixing valves with analog actuator

Code	Type	Price €	Unit/Box
555 0114	-		1/4

## SMRC - SLAVE MODULE



### 5530S2

SMRC slave module expands and integrate basic functions of MHC master module, thus managing 4 mixing units with 3-point actuator or 2 twin circulating pumps, by means of 8 internal relays programming .



Distribution

#### TECHNICAL SPECIFICATIONS

- Inlet voltage: 12-24 Vac / Vdc
- Power consumption: 7 VA
- Relay capacity: 6 A 250Vac
- Protection category: IP40
- Protection class: II
- Operating room temperature: 0 ÷ 40 °C
- Relative humidity of operating environment: Up to 85 % at T=25 °C
- Storage temperature: 0 ÷ 60 °C
- Relative storage humidity: no condensation
- Shell: Plastic ABS
- Installation: on DIN track (6 modules)
- 8 relay outlets to open/close 3-point mixing valves or 8 relays to turn 2 twin pumps ON/OFF
- Size (LxHxP): 105 x 95 x 60 mm (6 DIN modules)

**i** To manage 4 mixing valves with 3-point actuator or twin circulating pumps

Code	Type	Price €	Unit/Box
555 0154	-		1/4

## SACS - SLAVE MODULE



### 5530S3

SACS slave module expands and integrate basic functions of MHC master module, allowing to manage the domestic hot water storage system. Specifically, it manages storage temperature and safety, domestic hot water flow temperature, the Legionella prevention cycle, and any integration with electrical resistor.



DHW

#### TECHNICAL SPECIFICATIONS

- Inlet voltage: 12-24 Vac / Vdc
- Power consumption: 7 VA
- Relay capacity: 6 A 250Vac
- Protection category: IP40
- Protection class: II
- Operating room temperature: 0 ÷ 40 °C
- Relative humidity of operating environment: Up to 85 % at T=25 °C
- Storage temperature: 0 ÷ 60 °C
- Relative storage humidity: no condensation
- Shell: Plastic ABS
- Installation: on DIN track (6 modules)
- Inlets:
  - 1 inlet for safety thermostat for domestic hot water tank (free contact)
  - 1 inlet for thermal protection of recirculation pump
  - 1 inlet for thermal protection of resistors
  - 4 inlets (NTC) for storage (top and bottom) flow and return probes
  - 1 inlet (NTC) to manage generator priority
- Outgoes:
  - 1 relay to switch recirculation pump on
  - 2 relays to switch electrical resistors on
  - 1 outlet with powered Legionella prevention cycle
  - 2 relays to control 3 point mixing valves
  - 1 outlet to control domestic hot water mixing valve
- Size (LxHxP): 105 x 95 x 60 mm (6 DIN modules)

**i** To handle domestic hot water production system

Code	Type	Price €	Unit/Box
555 0115	-		1/4



## SKNX - SLAVE MODULE



### 5530S10

Bus domotics SKNX adapter allows to interface between communication protocols widely employed automated environments. SKNX module enables the interaction between several building subsystems, by operating on KONNEX bus networks. To be coupled with GATEWAY module.



#### TECHNICAL SPECIFICATIONS

- Inlet voltage: 12-24 Vac / Vdc
- Power consumption: 7 VA
- Protection category: IP40
- Protection class: II
- Operating room temperature: 0 ÷ 40 °C
- Relative humidity of operating environment: Up to 85 % at T=25 °C
- Storage temperature: 0 ÷ 60 °C
- Relative storage humidity: no condensation
- Shell: Plastic ABS
- Installation: on DIN track (2 modules)
- Ports:
  - RS232 standard for interfacing with GATEWAY module
  - Bus KNX connection (signal + power supply)

**i** To communicate with Konnex networks

Code	Type	Price €	Unit/Box
555 0320	-		1/10

## GATEWAY - SLAVE MODULE



### 5530S11

GATEWAY slave module allows to remotely manage the entire advanced Climav 2.0 Building Management thermoregulation system, by using the APP (available for both Android and IOS). Moreover, it is needed for interfacing with MODBUS-based external systems and, with SKNX module, with KONNEX systems.



#### TECHNICAL SPECIFICATIONS

- Inlet voltage: 12-24 Vac / Vdc
- Power consumption: 7 VA
- Protection category: IP40
- Protection class: II
- Operating room temperature: 0 ÷ 40 °C
- Relative humidity of operating environment: Up to 85 % at T=25 °C
- Storage temperature: 0 ÷ 60 °C
- Relative storage humidity: no condensation
- Shell: Plastic ABS
- Installation: on DIN track (2 modules)
- Ports:
  - WiBus on 485 network for interfacing with CLIMAV visor
  - RS232 standard for interfacing with KNX, MODBUS
  - Ethernet RJ45 10/100 Mb

**i** For remote communication with Climav 2.0 Building Management system

Code	Type	Price €	Unit/Box
555 0346	-		1/10

## MPW22COM - POWER SUPPLY UNIT



### 5530M2COM

230/24 Vac power supply unit to feed the entire Climav 2.0 Building Management thermoregulation system.

#### TECHNICAL SPECIFICATIONS

- Inlet voltage: 100 ÷ 230 Vac / 50 ÷ 60 Hz
- Output voltage: 24 Vdc
- Power consumption: 45 W
- Electronic protections: thermal, overcharge, short circuit
- Protection category: IP20
- Protection class: II
- Operating room temperature: -10 ÷ 60 °C
- Relative non-condensed humidity: <95 %
- Storage temperature: 0 ÷ 60 °C
- Shell: ULP4V-0 fireproof thermoplastic
- Installation: on DIN track (4 modules)
- Size (LxHxP): 70 x 90 x 66 mm (4 DIN modules)

Code	Type	Price €	Unit/Box
555 0338	-		1/4

## RC\_SA - CLIMATE CONTROL



### 5530M5 5530M6

RC\_SA climate control allows to control fluid medium temperature in heating and climate regulation systems, by controlling a mixing valve with proportional or 3-point servomotor.

#### DESCRIPTION

The control enables the following management modes of fluid medium temperature:

- climate compensation by installing an external probe;
- climate compensation by installing an external and a room probe;
- compensation by analyzing system return temperature (only in heating mode).

Depending on connected devices, it is possible to control one or two different thermal zones and switch any neutral air dehumidifier on.

#### TECHNICAL SPECIFICATIONS

- Power supply: 85 ÷ 230 Vac 50/60 Hz or 24 Vac
- Consumption: 5 W
- Protection fuse: 1 A
- Graphic display: 1.8" color
- Size: no. 6 modules to be installed on DIN bar
- Keyboard programming: 7-key board
- Inlets:
  - Combined thermostat inlet:
  - Inlet for remote summer-winter switching
  - ON/OFF remote inlet
  - Climav 2.0 Building Management system room probe
  - 5530 external probe
  - 5530P inflow probe
  - 5530P return probe
- Outgoes:
  - 1 ON/OFF contact to switch the pump on
  - 1 ON/OFF contact to control the dehumidifier
  - 1 ON/OFF contact to switch the thermal zone on
  - 0-10 V to control proportional servomotor
  - 2 ON/OFF contacts to control 3-point servomotor
- Size (LxHxP): 105 x 95 x 60 mm (6 DIN modules)

 For system climate regulation

Code	Power supply	Price €	Unit/Box
art. 5530M5			
555 0302	85-230 Vac		1/4
art. 5530M6			
555 0304	24 Vac		1/4





## T\_EXT



### 5530E

Temperature and humidity external probe

Used in Climav 2.0 Building Management thermoregulation system to compensate in climate regulation.

#### TECHNICAL SPECIFICATIONS

- Resistance: 10Kohm at 25 °C
- Protection class: II
- Shell: Plastic ABS
- Installation: on the wall
- Protection category: IP54
- Measuring range: -40 ÷ +110 °C
- External environmental temperature: 15 ÷ 55 °C
- External relative humidity: up to 85 % at T=25 °C
- Storage temperature: 0 ÷ 60 °C
- Relative storage humidity: no condensation
- Size: 74 x 109 x 59 mm

Code	Type	Price €	Unit/Box
555 0145	-		1/4



### 5530P

NTC 10KΩ @ 25°C, 6 mm diameter temperature probe

Code	Type	Price €	Unit/Box
555 0149	-		1/10

## T\_G



### 5530E2

Wall installation temperature environmental probe

#### TECHNICAL SPECIFICATIONS

- Size (LxHxP): 120 x 80 x 20 mm

**i** To be placed in each room and connected to Climav 2.0 Building Management system.

Code	Color	Price €	Unit/Box
555 0140	□ White		1/4
555 0342	■ Black		1/4

## TH\_G



### 5530E1

Wall installation temperature/humidity environmental probe

#### TECHNICAL SPECIFICATIONS

- Size (LxHxP): 120 x 80 x 20 mm

**i** To be placed in each room and connected to Climav 2.0 Building Management system.

Code	Color	Price €	Unit/Box
555 0139	□ White		1/4
555 0340	■ Black		1/4

## T\_P

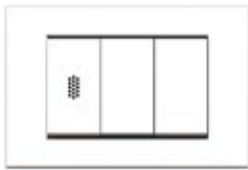

**553019**  
In-built temperature  
environmental probe.

- i** To be placed in 503 box. Signal the civil series employed (e.g., Vimar Idea, Piana, Bticino Light, Light Tech, etc.) to Tiemme's technician, so as to match the house's aesthetic features.
- i** To be placed in each room and connected to Climav 2.0 Building Management system.

Code	Civil line	Price €	Unit/Box
555 0327	upon request		1/40

## TH\_P

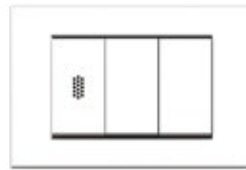

**5530110**  
In-built temperature/humidity  
environmental probe.

- i** To be placed in 503 box. Signal the civil series employed (e.g., Vimar Idea, Piana, Bticino Light, Light Tech, etc.) to Tiemme's technician, so as to match the house's aesthetic features.
- i** To be placed in each room and connected to Climav 2.0 Building Management system.

Code	Civil line	Price €	Unit/Box
555 0329	upon request		1/40



# 07 TEMPERATURE CONTROLS

**07A Thermostats and chronothermostats**



182

**07B Wireless temperature controls**



182

**07C Wi-Fi temperature controls**



184



**9573**  
Built-in electronic room thermostat

**TECHNICAL SPECIFICATIONS**

- Power supply: Two AAA 1.5 V batteries
- Outlet: 8(5) A/250 Vac no voltage input exchange relay
- Function SUMMER-WINTER-OFF
- Adjusting range: 2-50°C
- Min. switching time: 1 minute
- Differential: adjustable from 0.1 to 1°C

Thanks to different assembly frames provided, the thermostat can be adjusted to widespread plaques and integrated with the civil series employed.

Code	Type	Price €	Unit/Box
957 0008	electronic		1/5



**9574**  
Built-in digital weekly chronothermostat

**TECHNICAL SPECIFICATIONS**

- Power supply: Two AAA 1.5 V batteries
- Outlet: 8(5) A/250 Vac no voltage input exchange relay
- Function SUMMER-WINTER
- Adjusting range: 2-50°C
- Daily resolution: 1 hour
- Differential: adjustable from 0.1 to 1°C

Thanks to different assembly frames provided, the thermostat can be adjusted to widespread plaques and integrated with the civil series employed.

Code	Type	Price €	Unit/Box
957 0015	weekly electronic		1/5

# 07<sub>B</sub> WIRELESS TEMPERATURE CONTROLS



**4601**  
Electronic touchscreen wireless room thermostat

**TECHNICAL SPECIFICATIONS**

- Touchscreen display
- Power supply: 2 batteries 1.5V (type AAA)
- Battery life: 1 year
- Transmission frequency: 433.92 MHz
- SUMMER-WINTER-OFF switch
- Adjustment range: 2-50°C
- Differential: adjustable from 0.1 to 1°C

Code	Type	Price €	Unit/Box
957 0156	electronic		1/10

**OPERATION ART. 4606**

Loading (air conditioner, boiler, etc.) is activated by the remote receiver controlled by the thermostat (included in the kit) via a radio frequency signal. In this way it is possible to place the thermostat in any point of the house, without a wired connection.



**4606**  
Wireless temperature adjustment system with touchscreen thermostat and single-channel receiver

**TECHNICAL SPECIFICATIONS**

- THERMOSTAT**
- see TECHNICAL SPECIFICATIONS art. 4601
- RECEIVER**
- see TECHNICAL SPECIFICATIONS art. 4607

Code	Type	Price €	Unit/Box
957 0157	electronic		1/4

For the complete range, please refer to the Hydraulic components catalog.



## OPERATION ART. 4607

Load activation (air-conditioning, boiler etc) occurs via the remote receiver which is remote controlled by the thermostat/chronothermostat (ordered separately) across a radio frequency signal. This makes it possible to situate the the thermostat anywhere within your home without having to run cabling.



**4607**  
Single-channel radio receiver with control for boiler/heat pump/circulating pump

### TECHNICAL SPECIFICATIONS

- Power supply: 230 VAC 50 Hz
- 2 DIN module version
- Outlet: free changeover relay rated 8 A (230VAC)

Code	Type	Price €	Unit/Box
957 0183	electronic		1/25

## OPERATION ART. 4612

It has been designed to control climate control (hot/cold) equipment by receiving control signals originating from wireless thermostats/chronothermostats (ordered separately) across a radio frequency signal. Features six relays to control up to six zone valves plus a further relay for connecting the circulation pump. Activation of this latter control can be delayed (from 3 seconds to f5 minutes) using the trimmer on the front.



**4612**  
Six-channel wireless receiver electrothermal actuators 9567

### TECHNICAL SPECIFICATIONS

- Power supply: 230 VAC 50 Hz
- No. channels: 6
- Actuator control: 5 A (230VAC) relay contact
- Pump control: 5 A (230VAC) relay contact
- Pump control delay settable from 3 seconds to 5 minutes
- External antenna included in the packaging
- 4 DIN module version

Code	Type	Price €	Unit/Box
957 0158	electronic		1/4

## 4601-4612-9567

### INSTALLATION EXAMPLE

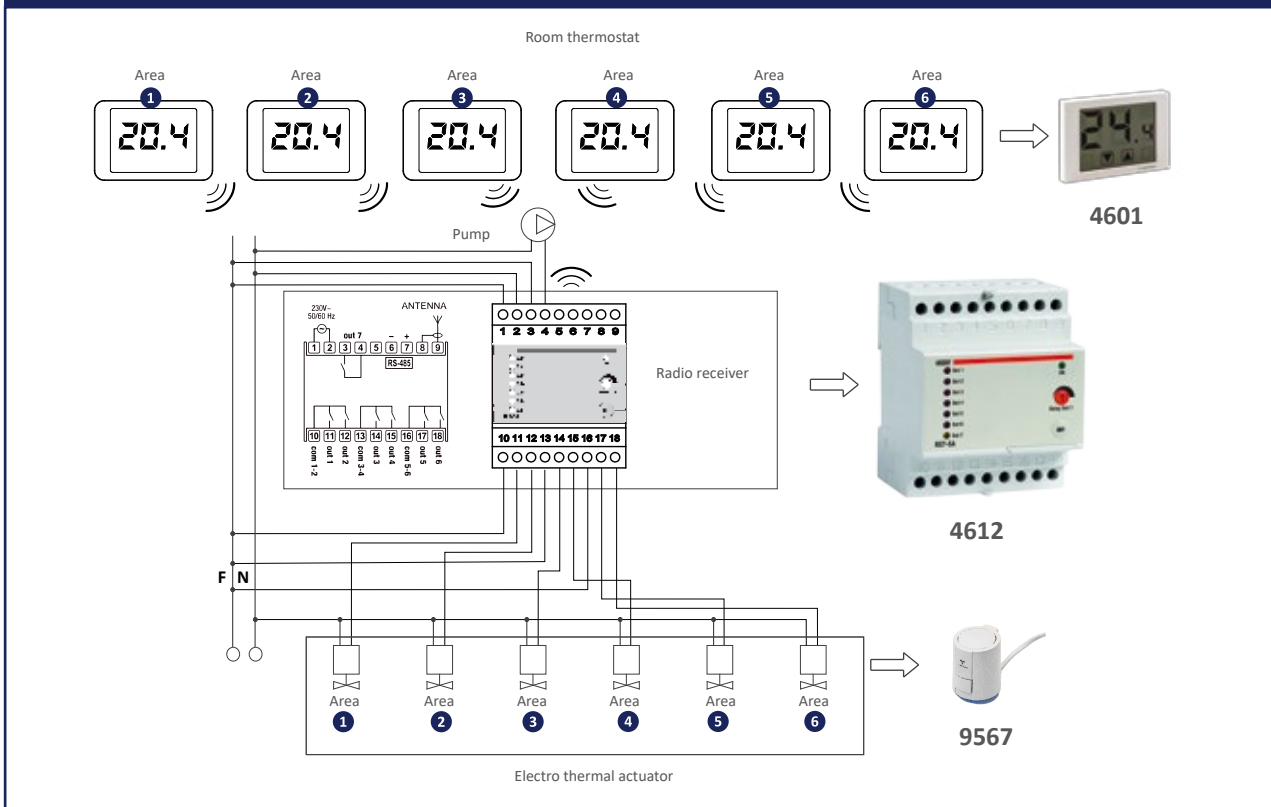

# 07c WI-FI TEMPERATURE CONTROLS

## TIEMME NEXT

Digital electronic chronothermostats with Wi-Fi communication can remotely manage climate control with an App.

Integrated Wi-Fi module allows to remotely control the chronothermostat with your smartphone. You only need to connect the device to your router and install the TIEMME NEXT App on your smartphone, freely available for iOS and Android devices.

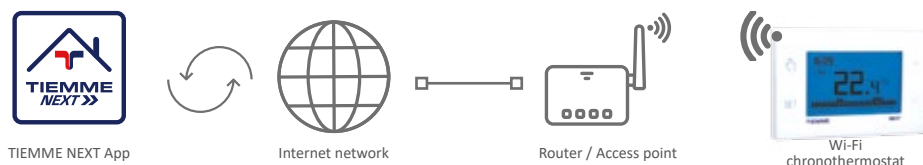

Available for



**9589**  
TIEMME NEXT wall weekly chronothermostat in white Wi-Fi communication.

### TECHNICAL SPECIFICATIONS

- Power supply: 230Vac  $\pm$  10% 50/60 Hz/ 4 x 1,5V batteries (AA)
- Outlet: 5 A (250 Vac) no voltage input exchange relay
- Winter/Summer/Off mode
- Schedule: Weekly with 3 levels of temperature (T1 - T2 - T3)
- Adjusting range: 2.0  $\div$  50.0 °C
- Temperature control: ON/OFF with adjustable differential (0.1  $\div$  1.0 °C) or proportional with adjustable range
- Wi-Fi module to connect with TIEMME NEXT App
- Installation: On the wall, 130 x 85 th.28 mm

Code	Type	Price €	Unit/Box
957 0201	230 Vac		1/10
957 0211	4 x 1,5 V AA		1/10



**9591**  
TIEMME NEXT IN built-in weekly chronothermostat (square box) . Wi-Fi communication

### TECHNICAL SPECIFICATIONS

- Power supply: 230Vac  $\pm$  10% 50/60 Hz
- Outlet: 5 A (250 Vac) no voltage input exchange relay
- Winter/Summer/Off mode
- Schedule: Weekly with 3 levels of temperature (T1 - T2 - T3)
- Adjusting range: 2.0  $\div$  50.0 °C
- Temperature control: ON/OFF with adjustable differential (0.1  $\div$  1.0 °C) or proportional with adjustable range
- Wi-Fi module to connect with TIEMME NEXT App
- Built-in (2 module) installation in the main residential series (Bticino, Vimar, Ave, Gewiss)

Code	Type	Price €	Unit/Box
957 0205	230 Vac		1/5



**9590**  
TIEMME NEXT RF wall weekly chronothermostat with humidity sensor in white. Wi-Fi communication and RF (radio frequency)

### TECHNICAL SPECIFICATIONS

- Power supply: 230Vac  $\pm$  10% 50/60 Hz
- Winter/Summer/Off mode
- Schedule: Weekly with 3 levels of temperature (T1 - T2 - T3)
- Adjusting range: 2.0  $\div$  50.0 °C
- Temperature control: ON/OFF with adjustable differential (0.1  $\div$  1.0 °C) or proportional with adjustable range
- Wi-Fi module to connect with TIEMME NEXT App
- Radio frequency module to manage 3 controls (Temperature/Humidity/CMV)
- Frequency range: 433.92 MHz
- Installation: On the wall, 130 x 85 th.28 mm

With humidity sensor

With integrated radio frequency module to communicate with radio receiver no. 4607 - 4612 or thermostatic head no. 9556W

Code	Type	Price €	Unit/Box
957 0203	230 Vac		1/10



**9592**  
TIEMME NEXT RD built-in weekly chronothermostat (round box). Wi-Fi communication



### TECHNICAL SPECIFICATIONS

- Power supply: 230Vac  $\pm$  10% 50/60 Hz
- Outlet: 5 A (250 Vac) no voltage input exchange relay
- Winter/Summer/Off mode
- Schedule: Weekly with 3 levels of temperature (T1 - T2 - T3)
- Adjusting range: 2.0  $\div$  50.0 °C
- Temperature control: ON/OFF with adjustable differential (0.1  $\div$  1.0 °C) or proportional with adjustable range
- Wi-Fi module to connect with TIEMME NEXT App
- Built-in installation (round box with 60 mm spacing)





Code	Type	Price €	Unit/Box
957 0207	230 Vac		1/5



## 08A Dehumidifiers

Dehumidifiers - introduction		186
Ceiling dehumidifiers		187
Wall dehumidifiers		188
Accessories and spare parts for dehumidifiers		189



## 08B Controlled mechanical ventilation

Controlled mechanical ventilation (CMV) - introduction		190
Central CMV		191
Ceiling CMV		194
CMV built-in wall installation		198
Wall/Floor CMV		200

## 08C Dehumidifiers with CMV

Dehumidifiers with CMV - introduction		202
Ceiling dehumidifiers with CMV		204
Wall dehumidifiers with CMV		205

## 08D Dehumidifiers with CMV with hydronic battery for heating and cooling

Dehumidifiers with CMV ceiling installation with hydronic battery for heating and cooling introduction		206
Dehumidifiers with CMV ceiling installation with hydronic battery for heating and cooling		207
Dehumidifiers with CMV wall installation with hydronic battery for heating and cooling		208

## 08E Accessories

	209
---	-----

Dehumidifiers included in series GH (ceiling liner ducted units), FH (vertical built-in units) and FHD (vertical design unit) are designed to be coupled with radiant panel cooling systems.

These units are made to guarantee dehumidification with both thermally neutral air, i.e., without temperature changes in incoming air, and cooled air.

Air flow rate is intentionally reduced to avoid air currents that are typical of traditional air conditioning systems.

FH, FHD and GH series units offered by TIEMME have the following features:

- they are made in hot-dip galvanized steel for improved resistance to corrosion. Carpentry is self-supporting and has removable panels that facilitate inspection and maintenance of internal components. The condensate receiver is included in all units and it is made in stainless steel;
- condensing and evaporating coils, as well as pre- and post-treatment water coils consist of copper pipes and aluminum wings. These exchangers' shape enables a low value of air pressure drop and allows to use low speed fans, resulting in a reduction of the machine's noise;
- the inflow fan is a double inlet brushless EC centrifugal fan;
- Coarse filter with low pressure drops easily extractable on the recirculation area;
- 3 different sizes available depending on the model (200 m<sup>3</sup>/h, 300 m<sup>3</sup>/h and 500 m<sup>3</sup>/h), 3 different installation modes (horizontal for the ceiling, vertical built-in and design vertical) and 2 different operation modes (cool and neutral air).

### DEHUMIDIFIERS IN NEUTRAL/COOL AIR

All FH and GH dehumidifiers can operate without pre- and post-cooling water coils. This function is extremely useful when dehumidification is required in middle seasons or when the air cooler is off. In the event that there is no cool water, the outgoing air will be warmer than the incoming air.

NOTE: Cool air versions can only operate if they are supplied with the system water (usually supplied at 15°C). In the event that there is no water, units will be switched off by safety devices connected to them.







### 5600GH 5600GHWZ

Neutral/cool air dehumidifiers, with 300 m<sup>3</sup>/h and 500 m<sup>3</sup>/h flow rate and horizontal ceiling installation.

Code	Model	Type	Price €	Unit/Box
558 0399	00GH-300	Neutral air		1/1
558 0400	00GH-500	Neutral air		1/1
558 0401	00GH-300-WZ	Cool air		1/1
558 0402	00GH-500-WZ	Cool air		1/1

### TECHNICAL SPECIFICATIONS

	558 0399	558 0400	558 0401	558 0402
Model	00GH-300	00GH-500	00GH-300 -WZ	00GH-500-WZ
Condensing humidity (26 °C - 65 R.R.%) (l/day)	18.9	36.2	18.9	36.2
Cooling capacity (W)*	580	1220	1270	2390
Power supply (V/pH/Hz)	230/1/50	230/1/50	230/1/50	230/1/50
Maximum electric power consumption (A)	3.2	5.3	3.2	5.3
Water flow rate (l/h)	150	300	150	300
Pressure drop (kPa)	4.5	9	4.5	9
Air flow rate (m <sup>3</sup> /h)	300	500	300	500
Working pressure (Pa)	150	90	150	90
Coolant	R134a	R134a	R134a	R134a
Sound pressure level (dB(A))	36	38	36	38
Height x Width x Thickness (mm)	250 x 690 x 690	310 x 690 x 800	250 x 690 x 690	310 x 690 x 800
Weight (kg)	40	53	42	55
Supply/return water connections	1/2" - 1/2"	1/2" - 1/2"	1/2" - 1/2"	1/2" - 1/2"
Condensate drain connection (mm)	16	16	16	16

\*Data applied to the following conditions: Room T. = 26 °C - R.H. 65% - T. H<sub>2</sub>O = 16 °C



### 5600FH 5600FHWZ

Neutral/cool air dehumidifiers, capacity 200 m<sup>3</sup>/h to 500 m<sup>3</sup>/h, vertical wall built-in installation.

Code	Model	Type	Price €	Unit/Box
558 0403	00FH-200	Neutral air		1/1
558 0404	00FH-300	Neutral air		1/1
558 0405	00FH-500	Neutral air		1/1
558 0406	00FH-300-WZ	Cool air		1/1
558 0407	00FH-500-WZ	Cool air		1/1

### 5600FHDWZ

Cool air dehumidifiers, capacity 300 m<sup>3</sup>/h to 500 m<sup>3</sup>/h, vertical wall design installation.

Code	Model	Type	Price €	Unit/Box
558 0408	00FHD-300-WZ	Cool air		1/1
558 0409	00FHD-500-WZ	Cool air		1/1

## TECHNICAL SPECIFICATIONS

	558 0403	558 0404	558 0405	558 0406 558 0408	558 0407 558 0409
Model	00FH-200	00FH-300	00FH-500	00FH-300-WZ 00FHD-300-WZ	00FH-500-WZ 00FHD-500-WZ
Condensing humidity (26 °C - 65 R.R.%) (l/day)	12.2	16.5	29.8	16.5	29.8
Cooling capacity (W)*	460	710	1060	1150	1840
Power supply (V/pH/Hz)	230/1/50	230/1/50	230/1/50	230/1/50	230/1/50
Maximum electric power consumption (A)	1.76	3.35	4.51	3.35	4.51
Water flow rate (l/h)	140	190	350	190	350
Pressure drop (kPa)	11	14	22	14	22
Air flow rate (m <sup>3</sup> /h)	220	320	500	320	500
Working pressure (Pa)	8	10	10	10	10
Coolant	R134a	R134a	R134a	R134a	R134a
Sound pressure level (dB(A))	36	38	40	38	40
Height x Width x Thickness (mm)	**	**	**	**	**
				650 x 1140 x 190	650 x 1340 x 190
Weight (kg)	36	43	47	44	48
Supply/return water connections	1/2" - 1/2"	1/2" - 1/2"	1/2" - 1/2"	1/2" - 1/2"	1/2" - 1/2"
Condensate drain connection (mm)	16	16	16	16	16

\*Data applied to the following conditions: Room T. = 26 °C - R.H. 65% - T. H<sub>2</sub>O = 16 °C

\*\* for vertical wall installations, please refer to formwork size art. 5601A.



GH - FH - FHD series



## 5601PGH

Plenum for ceiling mounted dehumidifier GH – GHWZ model

**i** Compatible with GH - GHWZ models only

Code	Size	Price €	Unit/Box
558 0428	mandata 1 x Ø200		1/1
558 0429	mandata 2 x Ø160		1/1
558 0430	ripresa 1 x Ø200		1/1
558 0431	ripresa 2 x Ø160		1/1
558 0432	mandata 1 x Ø200		1/1
558 0433	mandata 2 x Ø160		1/1
558 0434	ripresa 1 x Ø200		1/1
558 0435	ripresa 2 x Ø160		1/1

Per macchina 00GH-300 e 00GH-300-WZ

Per macchina 00GH-500 e 00GH-500-WZ



## 5601A

Galvanized formwork for built-in wall installation. Compatible with FH - FHWZ models only

**i** Compatible with FH – FHWZ models only

Code	Size	Price €	Unit/Box
558 0410	915 x 750 x 175 mm		1/1
558 0411	1115 x 750 x 215 mm		1/1
558 0412	1315 x 750 x 215 mm		1/1

For 00FH-200

For 00FH-300 e 00FH-300-WZ

For 00FH-500 e 00FH-500-WZ



## 5601P

Front panel in white lacquered steel and RAL 9003 finish with air inlet and recirculation grid for wall built-in installation.

**i** Compatible with FH – FHWZ models only

Code	Size	Price €	Unit/Box
558 0413	972 x 754 x 9 mm		1/1
558 0414	1172 x 754 x 9 mm		1/1
558 0415	1372 x 754 x 9 mm		1/1

For 00FH-200

For 00FH-300 e 00FH-300-WZ

For 00FH-500 e 00FH-500-WZ



## 9683CU

Digital remote control for electronics with humidity probe. Available colors - black or white.

Code	Color	Price €	Unit/Box
957 0212	White		1/1
957 0213	Black		1/1



## 5601FGH

Replacement filter kit. Compatible with GH - GHWZ models

**i** Compatible with GH - GHWZ models only

Code	Model	Price €	Unit/Box
558 0416	00GH-300, 00GH-300-WZ		1/1
558 0417	00GH-500, 00GH-500-WZ		1/1



## 5601FFH

Replacement filter kit

**i** Compatible with FH - FHWZ e FHDWZ models only

Code	Model	Price €	Unit/Box
558 0418	00FH-200		1/1
558 0419	00FH-300, 00FH-300-WZ, 00FHD-300-WZ		1/1
558 0420	00FH-500, 00FH-500-WZ, 00FHD-500-WZ		1/1

The quality of the air we breathe can be compromised by polluting factors. Not only do these make air unpleasant to smell but they also make it dangerous for our health. Changing the air in a traditional way, like we do by opening windows, results in a significant thermal dispersion both in winter and summer, and in a subsequent increase in costs.

Over the last years, new regulations focusing on energy savings have required the installation of high quality windows with minimized infiltration of air. However, besides limited dispersion, inadequate air exchange can result into a series of problems like surface condensation. A high humidity concentration gives rise to unpleasant smell, wear of indoor finishes, and molds that could lead to allergies. Controlled mechanical ventilation is the most effective solution to this.

By suctioning foul air and releasing clean air drawn from the outside, polluting substances are removed and the formation of humidity is prevented.

The system develops in a non-invasive way. Only ending components are visible, it is easy to use and requires minimized operational and maintenance costs. A high-efficiency heat recovery unit allows to improve the energy class of the building, thus increasing its value. This is why Tiemme developed a complete range of controlled mechanical ventilation units, available in different sizes to meet volume, comfort, and cost requirements. Tiemme offers compact ceiling liner ducted solutions, ducted vertical solutions that can be installed in technical environment and ease filter maintenance and cleaning processes, along with decentralized solutions that require minimum masonry interventions and no ducts. Decentralized horizontal wall solutions are ideal in low-energy buildings and in renovations, requiring minimized installation works.

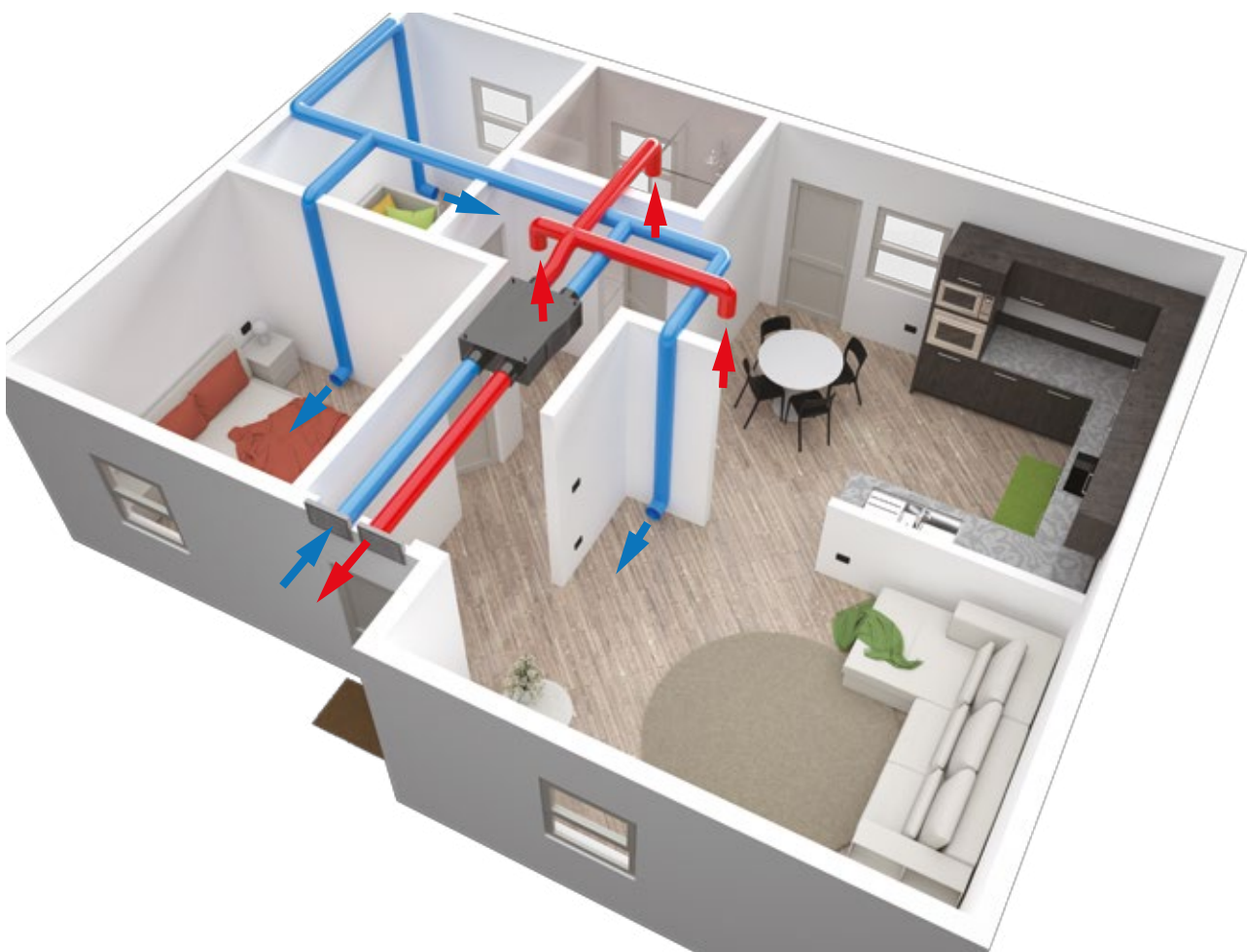

TIEMME EOLO is Tiemme's solution to install a controlled mechanical ventilation decentralized system with a highly efficient heat recovery.

TIEMME EOLO can be installed in new buildings or in renovations, guaranteeing the correct mechanical ventilation of rooms with low energy consumptions and enhancing the residential comfort of ventilated environment, with improved indoor air quality.

The brushless axial fan with electronic engine that is installed on the machines brings high efficiency and low noise. All units come with a low pressure drop G3 filter that can be easily removed to perform maintenance on the unit front.

The regenerating alternate flow ceramic exchanger enables energy recovery and limited pressure drop. Shockproof PVC telescopic tube can be extended from 280 mm to 540 mm, so as to perfectly fit the machine's structure.

**TIEMME EOLO is available in two sizes: EOLO 01 with 8 to 24 m<sup>3</sup>/h flow rate (Ø 100 mm fitting) and EOLO 02 with 15 to 50 m<sup>3</sup>/h flow rate (fitting Ø 160 mm).** A MASTER model is also available in the two sizes, controlling up to 15 SLAVE units in Wireless transmission.

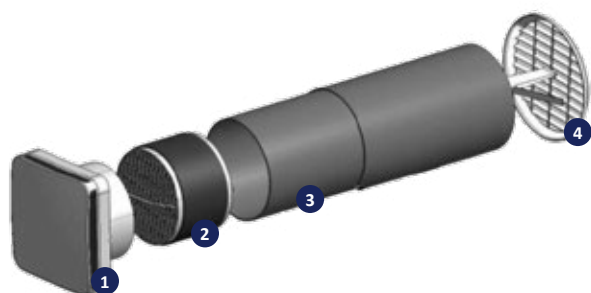

1. Header
2. Ceramic exchanger
3. Telescopic tube
4. External vent

### ADVANTAGES / STRENGTHS

- It can be easily installed in new buildings without CMV system or in renovations;
- It does not require air flow ducts;
- Reduced size for easy installation;
- Clean lines matching any room style;
- Highly efficient heat recovery units;
- High-efficiency ceramic exchanger with low pressure drop;
- Low electric consumptions;
- Noiseless operation;
- Remote controller to manage up to 16 units.

### PRODUCT RANGE



### 5506

CMV decentralized unit with high-performance heat recovery (up to > 90%) for horizontal bulkhead installation.

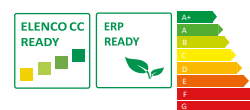

Code	Model	Type	Price €	Unit/Box
558 0388	EOLO 01 - M	Master		1/1
558 0390	EOLO 01 - S	Slave		1/1
558 0389	EOLO 02 - M	Master		1/1
558 0391	EOLO 02 - S	Slave		1/1

### OPERATION PRINCIPLE

TIEMME EOLO electronic machines are controlled with a radio-frequency remote controller. The remote controller allows to select the ventilation speed and the function mode, between extraction only, inlet only, or automatic heat recovery cycle. Sensor functioning mode can also be selected to automatically control ventilation and cycle duration, in order to optimize the heat recovery process.

- Combinations: 1 master + max 15 slaves
- Unit wireless connection

#### Master unit:

- 230V-1, 50Hz phase power supply;
- remote controller included.

#### Slave unit (master-slave spacing up to >10 m):

- configurable flow direction (= master or opposite for proper environment cleaning).
- Only electric supply (no wiring).

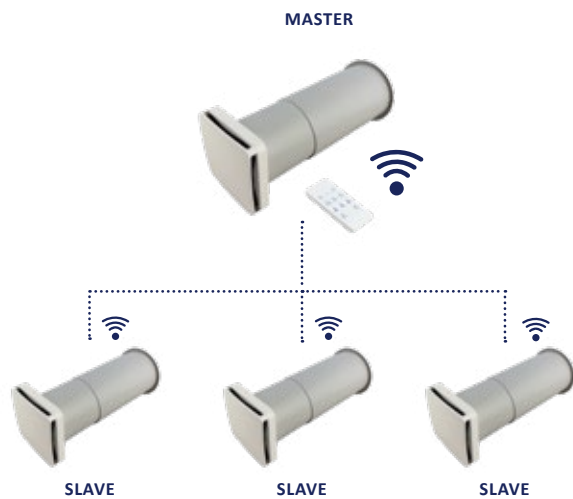

### MANUFACTURING SPECIFICATIONS

TIEMME EOLO consists of:

#### Structure

- single unit made in anti-static, high-efficiency, anti-UV ABS plastic, with coupled sections that can be easily installed and monitored;
- internal front vent (180x180 mm);
- external folding vent (190 mm) for both internal and external assembly.

#### Fan

- DC Brushless axial fan with electronic engine and modulating control;
- high efficiency (> 90%), low level of noise;
- Erp2015 compliant;
- made in tech ceramic with highly efficient exchange;
- low pressure drop.

#### Heat exchanger

- Regenerating ceramic alternate flow exchanger;
- High-efficiency exchange with low pressure drop.

#### Filter

- G3 class (EN-779);
- easily removable from the unit front.

### DIMENSIONS

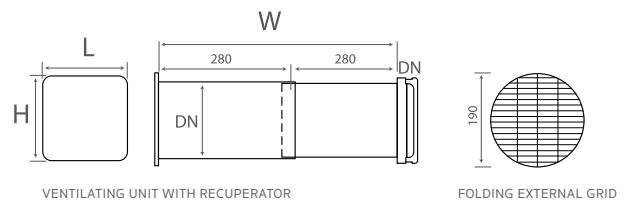

	EOLO 01 Master/Slave	EOLO 02 Master/Slave
DN (mm)	100	160
W (mm)	280/540	280/540
H (mm)	180	180
L (mm)	180	180
Weight (Kg)	2.7	4



### TECHNICAL SPECIFICATIONS

	EOLO 01 Master/Slave	EOLO 02 Master/Slave
<b>FANS</b>		
Fan type	Brushless DC axial	
Speed [Nr]	3	3
Nominal air flow rate [m <sup>3</sup> /h]	24	50
Cycle air flow rate [m <sup>3</sup> /h]	18	38
Air flow max/med/min speed [m <sup>3</sup> /h]	24/12/8	50/25/15
Cycle air flow max/med/min speed [m <sup>3</sup> /h]	18/9/6	38/20/12
Night air flow rate [m <sup>3</sup> /h]	5	10
<b>HEAT EXCHANGER</b>		
Type of exchanger	Brushless DC axial	
Recovery efficiency [%]	79	77
<b>FILTERS</b>		
Filter type	Flat filters	
Filtering class	G3	
<b>ACOUSTIC DATA</b>		
Lw max/med/min sound power [dBA]	39/37/34	44/38/29
Max/med/min sound pressure at 1 m [dBA]	28/26/23	32/26/18
<b>ELECTRICAL DATA</b>		
Voltage/Frequency [V/Ph/Hz]	230/1/50	230/1/50
Consumption [A]	0.21	0.25
Power consumption [W]	2	2.8
Protection rating [IP]	X4	X4

## DESCRIPTION

RECs are residential ventilation double-flow units with high-performance heat recovery. They are available in 4 sizes: REC 150, REC 200, REC 300 and REC 500.

REC 200 recovery unit provide performances measured and certified by the Building Research Establishment, UK. REC 150 and 200 are included in the KlimaHaus®/ClimateHouse Agency list of controlled mechanical ventilation devices with heat recovery.

## PERFORMANCE

Equipped with a Eurovent® certified aluminum counter-flow heat exchanger. Electronic backward curved fans allow to reach a maximum flow rate of about: 140 m<sup>3</sup>/h at 100 Pa (REC 150) with 62 Watt consumption, 220 m<sup>3</sup>/h at 100 Pa (REC 200) with 97 Watt power consumption, 414 m<sup>3</sup>/h at 100 Pa (REC 300) with a 161 Watt power consumption and 582 m<sup>3</sup>/h at 100 Pa (REC 500) with a 339 Watt power consumption. Standard total Bypass allows to exploit external favorable climate conditions for automatic free cooling (or free heating).

## STRUCTURE

REC machines consist of a self-supporting structure with 22mm thick sandwich panels, insulated with polyurethane foam. Both the structure and inner walls are made in Aluzinc®, a material with high resistance to corrosion. A panel that can be hinge-opened grants easy to access the filters ePM10 50% (G4) for the fresh air flow and ePM10 50% (G4) for the extract air flow. They are designed to be installed in buildings with 0°C÷45°C room temperature, they can be installed on the ceiling or floor. For sizes 300 and 500 the machine must not be turned upside down.

## CONTROLS

For the sake of a quick installation, machines include a control system connected to the electrical supply network. TM-EVO standard control has a back lightened color touch screen interface that enables an intuitive check of the machine's functioning status and allows to control fan speed. It provides a weekly schedule for automatic control of fans and can be controlled by an external switch to activate booster mode. Moreover, it automatically adjusts the air flow rate if connected to an air quality sensor. TM-EVO supports further post air treatment accessories and By-pass. It prevents the heat exchanger from frosting by controlling fan speed or, if any, an electric pre-heating coil (optional, not included). It is able to signal that filters need to be replaced (filter clogging is monitored by a couple of standard differential pressure switches) or that malfunctioning has arisen, specifying the origin.





### PRODUCT RANGE



### 55040

Horizontal ceiling ventilation unit with high-efficiency heat recovery unit.



Code	Model	Price €	Unit/Box
558 0382	REC 150		1/1
558 0383	REC 200		1/1

### OPERATION PRINCIPLE

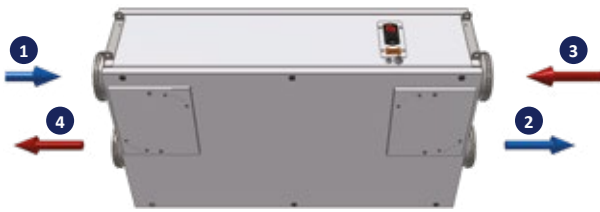

1. Fresh air
2. Injection
3. Extraction from the room
4. Expulsion to the outside

### DIMENSIONS

#### REC 150

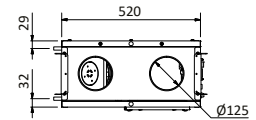
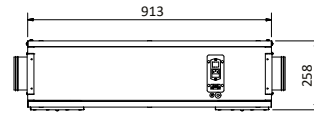
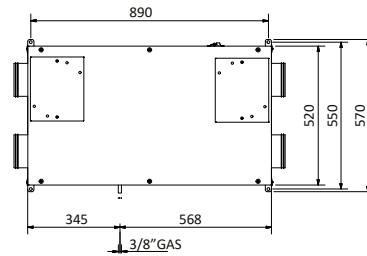

REC 150 weight: 31 kg

#### REC 200

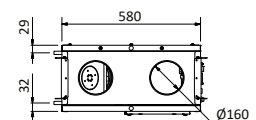
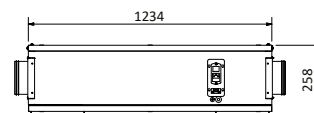
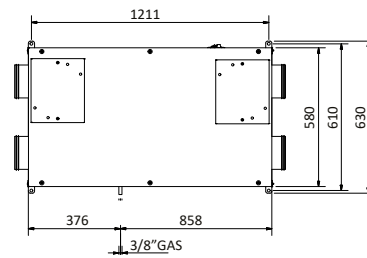

REC 200 weight: 42 kg

### PRODUCT RANGE



### 550401

Horizontal ceiling ventilation unit with high-efficiency heat recovery unit.



Code	Model	Price €	Unit/Box
558 0384	REC 300		1/1
558 0385	REC 500		1/1

### OPERATION PRINCIPLE



1. Fresh air
2. Injection
3. Extraction from the room
4. Expulsion to the outside

### DIMENSIONS REC 300 AND REC 500

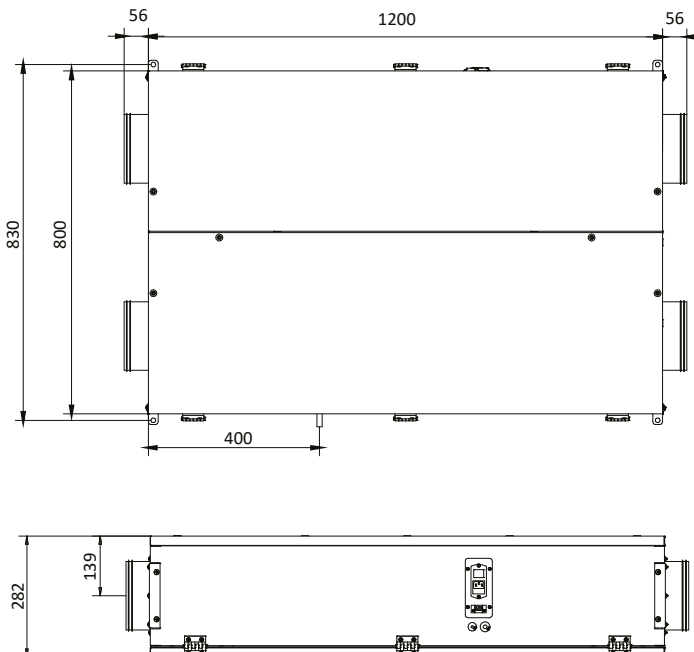

REC 300 weight: 60 kg  
 REC 500 weight: 61 kg  
 Note: same case for REC 300 and REC 500

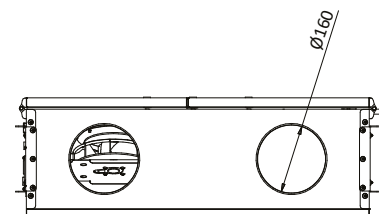

### TECHNICAL SPECIFICATIONS

REC leakage test compliant to UNI EN 13141-7					
Leakage	Test conditions	Class REC 150	Class REC 200	Class REC 300	Class REC 500
EXTERNAL	Positive pressure 250 Pa	A2	A1	A1	A1
EXTERNAL	Negative pressure 250 Pa	A2	A1	A1	A1
INTERNAL	Pressure difference 100 Pa	A2	A1	A2	A2

Noise levels									
L <sub>w</sub> Sound power level measured in compliance with UNI EN ISO 3747 CLASS 3 (REC 150, 300 e 500) and UNI EN ISO 3741 CLASS 1 (REC 200-BRE tested)									
Noise from the case (dB)									
REC 150 Unit		125 Hz	250 Hz	500 Hz	1000 Hz	2000 Hz	4000 Hz	8000 Hz	L <sub>w</sub> db (A)
MAX		50,9	62,6	59,5	48,2	41,5	34,9	38,6	58,9
REF		52,4	58,5	52,1	41,2	35,9	32,3	40,3	53,2
Noise in the duct (dB)									
REC 150 Unit		125 Hz	250 Hz	500 Hz	1000 Hz	2000 Hz	4000 Hz	8000 Hz	L <sub>w</sub> db (A)
MAX		59,2	65,5	68,5	56,5	53,5	54,4	58,3	67,4
REF		54,0	65,2	61,5	47,9	43,7	43,4	44,0	61,1
Noise from the case (dB)									
REC 200 Unit	63 Hz	125 Hz	250 Hz	500 Hz	1000 Hz	2000 Hz	4000 Hz	8000 Hz	L <sub>w</sub> db (A)
MAX	49,4	49,1	55,9	63,6	54,4	50,6	41,7	26,4	62,0
REF	55,8	44,9	53,6	53,6	49,5	43,6	33,2	20,8	53,7
Noise in the duct (dB)									
REC 200 Unit	63 Hz	125 Hz	250 Hz	500 Hz	1000 Hz	2000 Hz	4000 Hz	8000 Hz	L <sub>w</sub> db (A)
MAX	59,8	61,6	64,4	74,0	59,5	60,1	59,6	49,7	72,1
REF	57,9	56,0	61,5	67,8	53,4	54,1	51,5	41,2	65,2
Noise from the case (dB)									
REC 300 Unit		125 Hz	250 Hz	500 Hz	1000 Hz	2000 Hz	4000 Hz	8000 Hz	L <sub>w</sub> db (A)
MAX		62,6	66,9	69,6	49,4	48,6	42,9	45,9	67,3
REF		55,6	63,0	56,9	47,2	41,8	35,2	41,1	57,8
Noise in the duct (dB)									
REC 300 Unit		125 Hz	250 Hz	500 Hz	1000 Hz	2000 Hz	4000 Hz	8000 Hz	L <sub>w</sub> db (A)
MAX		62,1	69,9	72,9	60,6	58,6	59,1	67,7	72,7
REF		58,9	66,0	66,6	56,6	54,8	53,3	59,4	66,6
Noise from the case (dB)									
REC 500 Unit		125 Hz	250 Hz	500 Hz	1000 Hz	2000 Hz	4000 Hz	8000 Hz	L <sub>w</sub> db (A)
MAX		62,2	69,7	73,2	54,4	51,2	46,5	44,1	70,7
REF		56,1	69,2	62,8	49,7	44,8	40,3	42,5	63,5
Noise in the duct (dB)									
REC 500 Unit		125 Hz	250 Hz	500 Hz	1000 Hz	2000 Hz	4000 Hz	8000 Hz	L <sub>w</sub> db (A)
MAX		70,6	76,5	79,8	68,8	65,5	65,7	70,7	78,9
REF		64,8	75,5	69,9	60,2	58,6	58,0	61,8	71,4

Electrical information						
Unit	Fan				REC Unit	
	Power*(W)	Power supply	Max voltage (A)	Insulation class	Power supply	Max voltage (A)
REC 150	2 X 27	230 V, 50/60 Hz 1F	2 X 0,27	IP 44 classe B	230V, 50 Hz 1F	0,6
REC 200	2 X 50	230 V, 50/60 Hz 1F	2 X 0,46	IP 44 classe B	230V, 50 Hz 1F	1,1
REC 300	2 X 85	230 V, 50/60 Hz 1F	2 X 0,75	IP 54 classe B	230V, 50 Hz 1F	1,6
REC 500	2 X 170	230 V, 50/60 Hz 1F	2 X 1,65	IP 54 classe B	230V, 50 Hz 1F	3,5

(\*) Fan plate information, see the chart for the device global absorbed power in the operating point.

The installation of ceiling ventilation units is the most popular solution on the market.

This type of operation is particularly suitable for small spaces, which do not allow the pipes to be positioned correctly. It reduces the performance of the entire system and makes maintenance difficult, which the end user often does not perform.

TIEMME has the solution to this problem: years of research and experience in the sector have led the company to develop a built-in CMV system, easy to install, aesthetically nice and minimally bulky. This is the RECI 150 and RECI 220, an innovative solution, with effective aerodynamic performances, designed to ensure optimal ventilation, high hygiene and maximum health of the living room interiors. The VMC system specifically integrates all the components within a single metal product.

### WALL BUILT-IN CMV SYSTEM: THE BENEFITS OF RECI 150 AND RECI 220

The RECI 150 and RECI 220 machines can be installed outside the house, placed on a terrace or in another location sheltered from direct rain. In this way, the solution proposed by Tiemme revolutionizes the positioning of the CMV in homes and offers considerable savings in the cleaning of filters and in the maintenance of the system, which can be carried out directly by the user without relying on external technicians.

### OPERATION PRINCIPLE



1. Fresh air
2. Injection
3. Extraction from the room
4. Expulsion to the outside

### PRODUCT RANGE

NEW



#### 5507

Ventilation unit with high efficiency heat recovery unit for vertical recessed installation



Code	Model	Price €	Unit/Box
558 0392	RECI 150		1/1
558 0393	RECI 220		1/1

NEW



#### 5507T

Built-in frame for ventilation unit with high efficiency heat recovery unit for vertical recessed installation

*i* Compatible with RECI models only

Code	Model	Price €	Unit/Box
558 0394	682 x 1525 x 225 mm		1/1
558 0395	762 x 1525 x 275 mm		1/1

For RECI 150

For RECI 220

NEW



#### 5507COP

Built-in frame cover for ventilation unit with high efficiency heat recovery unit for vertical flush-mounted installation

*i* Compatible with RECI models only

Code	Model	Price €	Unit/Box
558 0396	-		1/1
558 0397	-		1/1

For RECI 150

For RECI 220



NEW



### 5507COM

Digital remote control for machines 5507.  
Available color white

**i** Compatible with RECI models only

Code	Model	Price €	Unit/Box
957 0219	<input type="checkbox"/> White		1/1

## DIMENSIONS

### RECI 150

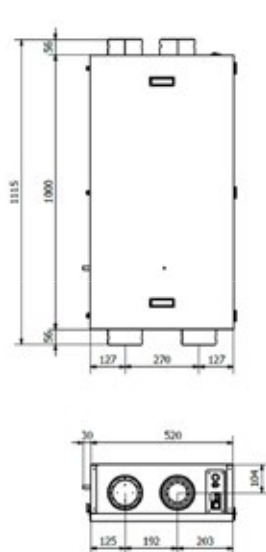

RECI weight 150: 37 kg

### RECI 220

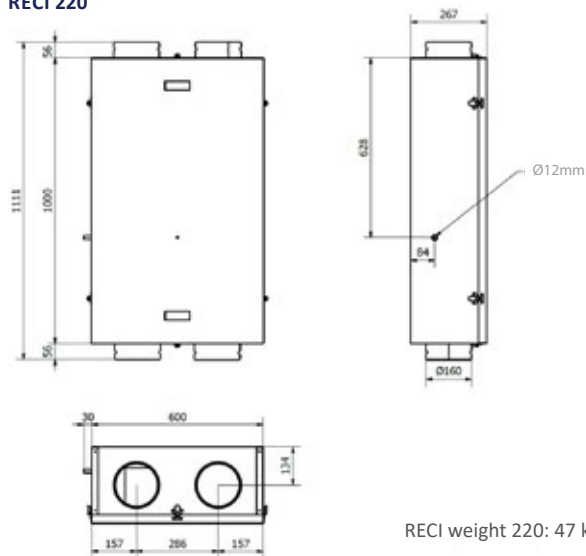

RECI weight 220: 47 kg

## TECHNICAL SPECIFICATIONS

		RECI 150	RECI 220
Specific energy consumption for each climate zone and SEC class	Cold climate	75,2 kWh/m <sup>2</sup> .a	73,7 kWh/m <sup>2</sup> .a
	Mild climate	37,5 kWh/m <sup>2</sup> .a	36,4 kWh/m <sup>2</sup> .a
	Warm climate	13,3 kWh/m <sup>2</sup> .a	12,4 kWh/m <sup>2</sup> .a
Energy class		A	
Type of product		UVR, bidirectional	
Type of motor		Variable speed	
Heat recovery system		Counter-flow heat exchanger	
Heat recovery thermal efficiency *		85,3 %	83,9 %
Maximum flow rate *		172 m <sup>3</sup> /h	269 m <sup>3</sup> /h
Electrical power absorbed at maximum flow rate *		100 W	173 W
Sound power level (Lwa)		52 dB(A)	51 dB(A)
Reference range *		0,033 m <sup>3</sup> /s	0,052 m <sup>3</sup> /s
Pressure difference *		50 Pa	
Power consumption		0,31 W/(m <sup>3</sup> /h)	0,35 W/(m <sup>3</sup> /h)
Control type		Centralised environmental control	
Control coefficient		0,85	
Operating conditions		Temperature environmental: 0 °C ÷ + 45 °C Humidity: < 80 %	

(\*) as per Regulation No 1253/2014

### DESCRIPTION

REC-V are residential ventilation double-flow units with high-performance heat recovery. 2 sizes available: REC 30V and REC 50V, both also available with enthalpy exchanger upon request.

REC-V are included in the KlimaHaus®/ClimateHouse Agency list of controlled mechanical ventilation devices with heat recovery.

### PERFORMANCE

REC-V units are equipped with a thermoplastic (polystyrene) counter-flow heat exchanger and electronic backward curved fans. Standard total Bypass allows to exploit external favorable climate conditions for automatic free cooling (or free heating).

### STRUCTURE

REC 30V and REC 50V consist of a self-supporting structure with 23 mm thick sandwich panels, insulated with polyurethane foam. The external part of the structure is made in gray plastofilm sheet while the internal part of the panels is in Aluzinc® (a material with a high resistance to corrosion).

The inside of REC-V units is in polypropylene foam, a material that confers high thermal insulation between air flows.

Filters (ePM10 50% (G4) for the fresh air flow and ePM10 50% (G4) for the extract air flow) are easy to access thanks to two openings on the front panel. The enthalpy heat exchanger (available upon request) allows to recover sensible and latent energy from air. This is due to the fact the water vapor is transferred from one flow to another and is absorbed on one side of the porous membrane of the exchanger and is then transferred on the opposite side. In this way no vapors, odors, etc. are injected. The condensation outlet is not required (regular maintenance).

The enthalpy exchanger is ideal for cold climate because, unlike the sensible exchanger, the inlet air has the correct humidity rate. REC 30V and REC 50V can be installed in buildings with 0°C - 45°C room temperature. They can be installed on the wall with connections for air renewal and expulsion, inflow and extraction. Available connections can be used on the top or bottom part of the unit.

### CONTROLS

For the sake of a quick installation, REC-V include a control system connected to the electrical supply network. TM-EVO control has a back lightened color touch screen interface that enables an intuitive check of the machine's functioning status and allows to control fan speed. It provides a weekly schedule for automatic control of fans and can be controlled by an external switch to activate booster mode. Moreover, it automatically adjusts the air flow rate if connected to an air quality sensor. TM-EVO supports further post air treatment accessories and By-pass, and prevents the heat exchanger from frosting by controlling fan speed or, if any, an electric pre-heating coil (optional, not included). It is able to signal that filters need to be replaced (filter clogging is monitored by a couple of standard differential pressure switches) or that malfunctioning has arisen, specifying the origin.

### PRODUCT RANGE



### 5504V

Vertical ceiling or wall ventilation unit with high-efficiency heat recovery unit.



**i** Recovery unit with enthalpy exchanger available upon request

Code	Model	Price €	Unit/Box
558 0386	REC 30V		1/1
558 0387	REC 50V		1/1

### DIMENSIONS

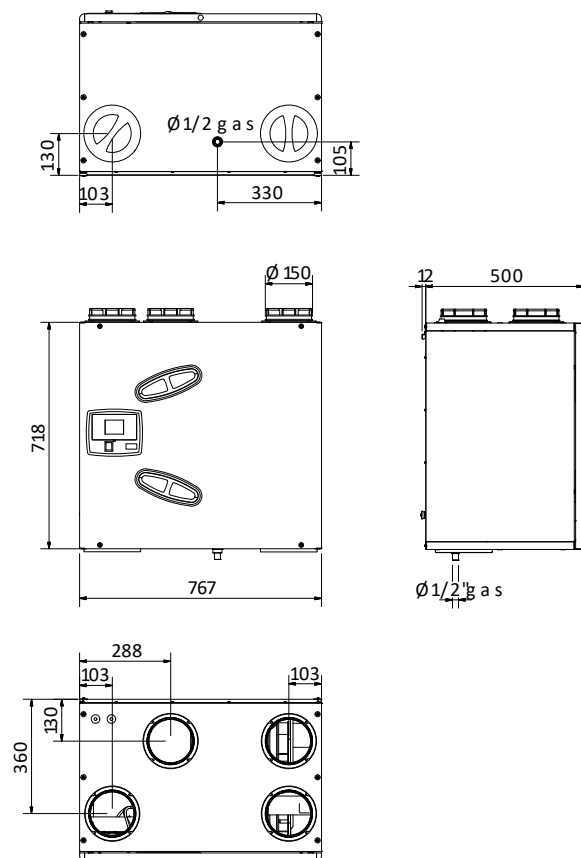

REC 30V weight: 43 kg  
 REC 50V weight: 45 kg  
 Note: same case for REC 30V and REC 50V



### TECHNICAL SPECIFICATIONS

REC-V leakage test compliant to UNI EN 13141-7			
Leakage	Test conditions	Class REC 30V	Class REC 50V
EXTERNAL	Positive pressure 250 Pa	A2	A1
EXTERNAL	Negative pressure 250 Pa	A2	A1
INTERNAL	Pressure difference 100 Pa	A2	A1

Noise levels								
L <sub>w</sub> Sound power level measured in compliance with UNI EN ISO 3741 CLASS 1								
Noise from the case (dB)								
REC 30V Unit	125 Hz	250 Hz	500 Hz	1000 Hz	2000 Hz	4000 Hz	8000 Hz	L <sub>w</sub> db (A)
MAX	48,3	52,9	52,2	47,7	52,5	41,2	31,1	56,1
REF	41,6	48,9	41,8	38,9	42,6	30,7	21,2	47,1
Noise in the duct (dB)								
REC 30V Unit	125 Hz	250 Hz	500 Hz	1000 Hz	2000 Hz	4000 Hz	8000 Hz	L <sub>w</sub> db (A)
MAX	52,6	66,2	63,8	56,1	53,5	53,1	63,7	66,5
REF	47,7	60,7	56,7	47,4	43,7	42,4	46,7	57,2
Noise from the case (dB)								
REC 50V Unit	125 Hz	250 Hz	500 Hz	1000 Hz	2000 Hz	4000 Hz	8000 Hz	L <sub>w</sub> db (A)
MAX	53,1	57,9	61,1	53,3	59,3	47,4	32,6	63,5
REF	47,1	55,1	50,2	47,2	50,7	37,5	25,9	55,1
Noise in the duct (dB)								
REC 50V Unit	125 Hz	250 Hz	500 Hz	1000 Hz	2000 Hz	4000 Hz	8000 Hz	L <sub>w</sub> db (A)
MAX	61,5	63,4	69,8	65,9	64,3	56,8	50,8	71,0
REF	54,1	60,1	60,8	57,1	56,4	48,3	42,1	62,8

Electrical information						
Unit	Fan				REC-V Unit	
	Power*(W)	Power supply	Max voltage (A)	Insulation class	Power supply	Max voltage (A)
REC 30V	2 X 85	230 V, 50/60 Hz 1F	2 X 0,75	IP 54 classe A	230V, 50 Hz 1F	1,6
REC 50V	2 X 170	230 V, 50/60 Hz 1F	2 X 1,65	IP 54 classe A	230V, 50 Hz 1F	3,5

(\*) Fan plate information, see the chart for the device global absorbed power in the operating point.

Dehumidifiers with air renewal, such as the GHWZ series (ceiling liner units) and GHWZW series (wall installation unit), are machines that are usually included in radiant systems to control the environment relative humidity and allow to renew foul air by using high efficiency recovery units.

The units available can be channeled and have a 300 m<sup>3</sup>/h or 500 m<sup>3</sup>/h nominal air flow rate.

They have two DC brushless fans with electronic automatic flow control which is set either by keyboard or remotely via bus and is kept constant whatever the distribution or in the face of a natural increase in pressure drops that occurs in the filters in the event of capture of suspended particles in the intake: the choice of two centrifugal fans with single intake capable of carrying twice the maximum flow rate treated by the machine has been made according to the extremely low noise generated for the same air flow rate typical of the machines normally on the market, which results to be three times lower than the PlugFans, improperly coupled to the high efficiency recovery units.

We paid special attention to the dehumidifying and condensation receiving section. To that end, a special paint has been applied, which forces the captured drops of moisture to fall into the receiver tray entirely made of stainless steel. This solution solves the problems linked to the formation of molds and colonies of bacteria, effectively preventing the stagnation of damp areas; for the very same reason the receiver tray features a sharp slope toward the vent.

By default, the filtering section is inserted in every air intake path in the machine and the filter may be extracted from several sides thanks to a great accessibility. As an accessory, it is possible to add a box to the outlet of the treated air where a selective filter can be housed, capable of retaining fine dust and pollen.

**It is also available a version of it with a germicidal LED lamp which uses low wavelength ultraviolet rays capable of killing all bacteria and viruses present in the treated air.**

The switchgear is located inside the machine and is mobile: by removing the rear panel the wiring operations are eased.

The hydraulic connection has two 1/2" brass openings, the air inlet is at the bottom close to the condensate discharge outlet, while the outlet is at the top to ease the expulsion of air through the side vent.

The outlet temperature of the air can be adjusted depending on the water flow rate and temperature: in nominal conditions the temperature of the inflow dehumidified air is about 2°C below room temperature, to guarantee neutrality in the sensible heat supply; by activating the integration along with dehumidification in summer months, a fresh air is the inflow outcome with a reduced heat resulting from the dehumidified air post-treatment.

The hydraulic circuit has a heat exchanger with finned battery, which performs a pre-treatment, lowering the sensible heat of the air that requires treatment, thus facilitating dehumidification by the evaporator. A valve with electro thermal actuator enables or prevents the water from flowing on a plate heat exchanger, thus releasing the thermal energy of the cooling circuit to the water, resulting in the treated air having a lower temperature compare with incoming air: this leads to the integration of sensible heat in the environment.





## OPERATION

### RENEWAL UPON BATHROOM REQUEST

When the presence sensor located in bathrooms closes contact, priority is given to the extraction of exhaust air from these rooms, with a subsequent introduction of external clean air in all the rooms. In order to reduce the energy consumption needed to bring external air temperature to desired conditions, the cross-flow high efficiency heat recovery system pre-processes and reduces the thermal difference of the renewed air by exploiting energy drawn from exhausted air. The EC energy saving and high static fan ejects exhausted air outside of the heat recovery system.



### RENEWAL + RECIRCULATION

When the quality of the air drops below the comfort level, the “renewal” mode switches on, thus injecting the recirculating air along with an amount of clean external air, so as to restore optimal levels of air quality. Even in this case, in order to reduce the energy supply required to bring the temperature of outdoor air to desired conditions, a high efficiency cross-flow recovery unit is used. By exploiting energy drawn from exhausted air, it can pre-treat and reduce the thermal difference of the renewal air. The EC energy saving and high static fan ejects exhausted air outside of the heat recovery system.



### RECIRCULATION

When the quality of indoor air conditions is good but there is a high level of humidity or outdoor conditions are worse than indoor ones, recirculating air can be treated so as to bring comfort without exceeding the energy demand. If the problem is due to an uneven temperature distribution in the different rooms, due to occasional heat sources like solar rays, the group can be activated in the ventilation mode alone, thus evening out the different rooms. In the event that the heating speed requires to be integrated or increased, especially in winter, ventilation can be activated in recirculation mode, thus making hot water flowing in the pre-treatment battery, resulting into a sensible heat integration. In summer, integration can also be combined with dehumidification.

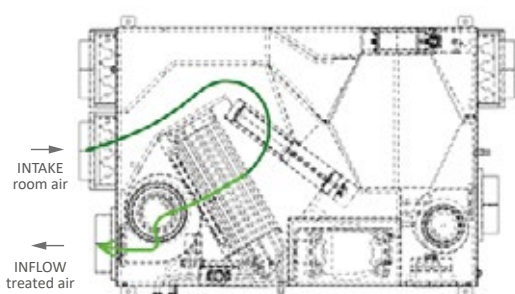

### FREECOOLING

If the temperature of outdoor air under renewal is better than indoor conditions (depending on the season), a passage is open to let the air flout the heat recovery unit and reach the air treatment area, thus reducing ventilation costs and benefiting from better external conditions. In this context, extraction with the recovery unit is optional, except for specific requests like the ones resulting from the sensor signaling “people in the bathroom”. By turning off the extraction fan and injecting renewed air, rooms undergo a slight overpressure condition, triggering air leaks in several points, such as doors, hoods or the heat recovery system.





### 5602GHWZ

High efficiency VMC dehumidifier with recuperator and renewal, ductable horizontal for false ceiling

Code	Model	Price €	Unit/Box
558 0421	02GH-300-WZ		1/1
558 0422	02GH-500-WZ		1/1
558 0423	02GH-300-WZ-LED		1/1
558 0424	02GH-500-WZ-LED		1/1

Version with LED lamp for disinfection against molds, bacteria, germs and viruses

### LED LAMPS SANITIZATION

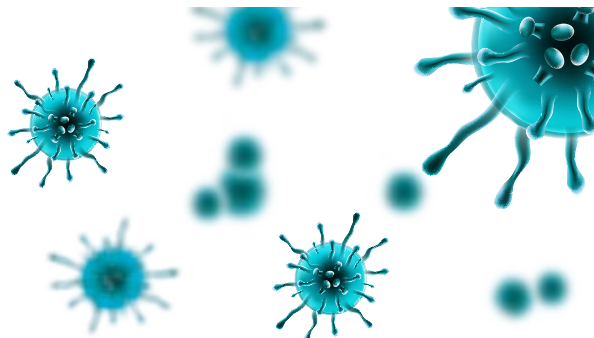

Purifying the air in the rooms is increasingly important, so to make sure we get healthy and quality air.

To achieve this result, in the Tiemme air treatment machines are housed LED germicide lamps which exploit a sterilization method called Ultraviolet Germicidal Irradiation (UVGI).

The "lamps" in the new machines emit ultraviolet rays at a wavelength between 250-280 nm, which irradiates the air flow, thus killing the bacteria present and ensuring clean air in the rooms.

### TECHNICAL FEATURES

	558 0421 - 558 0423	558 0422 - 558 0424
Model	02GH-300-WZ e 02GH-300-WZ-LED	02GH-500-WZ e 02GH-500-WZ-LED
Condensed humidity (26 °C - 65%) (l/day)	26	48
Nominal power consumption (W)	250	390
Maximum power consumption (W)	360	480
Cooling capacity (W)*	620	1550
Power supply (V/pH/Hz)	230/1/50	230/1/50
Water flow rate (15 °C) (l/h)	240	400
Chiller power consumption (W)	1100	2200
Maximum pressure drop (kPa)	5	20
Room air flow rate (m <sup>3</sup> /h)	150-300	200-600
Maximum inflow pressure (Pa)	300	250
Extraction air flow rate (m <sup>3</sup> /h)	70-200	100-250
Maximum expulsion pressure (Pa)	260	230
Coolant	R290 (55g)	R290 (140g)
Sound power level (dB(A))	44	47
Height x Width x Thickness (mm)	230 x 1204 x 716	280 x 1234 x 800
Weight (kg)	61	78
Supply/return water connections	1/2" - 1/2"	1/2" - 1/2"
Condensate drain connection (mm)	14	14

\*Data applied to the following conditions: Room T. = 26 °C - R.H. 65% - T. H<sub>2</sub>O = 16 °C





### 5502GHWZV

High efficiency VMC dehumidifier with recuperator and renewal, ductable vertical for wall

Code	Model	Price €	Unit/Box
558 0379	02GH-300-WZV		1/1
558 0380	02GH-500-WZV		1/1
558 0425	02GH-300-WZV-LED		1/1
558 0426	02GH-500-WZV-LED		1/1

Version with LED lamp for disinfection against molds, bacteria, germs and viruses

### TECHNICAL FEATURES

	558 0379 - 558 0425	558 0380 - 558 0426
Model	02GH-300-WZV e 02GH-300-WZV-LED	02GH-500-WZV e 02GH-500-WZV-LED
Condensed humidity (26 °C - 65%) (l/day)	36	48
Nominal power consumption (W)	300	480
Maximum power consumption (W)	590	530
Cooling capacity (W)*	920	1500
Power supply (V/pH/Hz)	230/1/50	230/1/50
Water flow rate (15 °C) (l/h)	360	400
Chiller power consumption (W)	1400	2100
Maximum pressure drop (kPa)	17	15
Room air flow rate (m <sup>3</sup> /h)	150 - 400	200 - 600
Maximum inflow pressure (Pa)	400	200
Extraction air flow rate (m <sup>3</sup> /h)	100 - 300	100 - 350
Maximum expulsion pressure (Pa)	450	300
Coolant	R134a (110g)	R134a (300g)
Sound power level (dB(A))	44	46
Height x Width x Thickness (mm)	1380 x 700 x 354	1690 x 700 x 434
Weight (kg)	58	60
Supply/return water connections	1/2" - 1/2"	1/2" - 1/2"
Condensate drain connection (mm)	14	14

\*Data applied to the following conditions: Room T. = 26 °C - R.H. 65% - T. H<sub>2</sub>O = 16 °C

The CMV system **with integrated air conditioning** is the innovative solution designed by Tiemme to combine **heating, cooling and air exchange** in a simple and convenient way.

The integration between low-consumption air conditioning and high-efficiency controlled mechanical ventilation ensures **indoor comfort and well-being** with significant energy savings.

VMC Clima is a versatile solution, particularly suitable for low-consumption homes, and in general for homes both newly built and under renovation, offices and small commercial premises.

Today all the buildings, new or renovated, are conceived with a good insulation to minimize the losses of heat.

This **reduces the building's thermal requirements** and allows the best use of low/medium temperature air conditioning systems. The greater isolation, however, brings with it the lack of air exchange, with the consequence of an accumulation of humidity and micro pollutants that make the living climate unhealthy.

In order to obtain **real living comfort** and at the same time to ensure **well-being and hygiene** inside the enclosed spaces, it is necessary to use a ventilation system that ensures the exchange of air in a controlled way and recovers the thermal energy otherwise dispersed.

Integrating the CMV with the air conditioning system is also an investment in the property.

The installation of a heat recuperator with very high efficiency, in fact, allows the dwelling to access the highest energy classes, consequently increasing their value.



NEW



### 55080

Controlled mechanical ventilation unit with high efficiency heat recovery unit - horizontal installation, with hydronic battery for heating and cooling

Code	Model	Price €	Unit/Box
558 0436	VMC CLIMA-H-50/25		1/1
558 0437	VMC CLIMA-H-60/15		1/1
558 0438	VMC CLIMA-H-90/25		1/1

### TECHNICAL FEATURES

	558 0436	558 0437	558 0438
Model	VMC CLIMA-H-50/25	VMC CLIMA-H-60/15	VMC CLIMA-H-90/25
Rated winter recuperator efficiency*	86	86,6	86,5
Rated summer recuperator efficiency **	84	83	84
Nominal external air flow	265	151	263
Maximum air flow rate	520	692	838
Cooling power hydronic battery output ***	3,32	3,7	5,56
Summer operation water flow	0,7	0,75	0,9
Summer operation pressure drop	17,6	18	20
Heat output ****	3,88	4,5	6,8
Winter operation water flow	0,7	0,75	0,9
Winter operation pressure drop	17,6	18	20
Sound pressure LP at 3 Mt	45	42,8	46,2
Power supply	230/1/50	230/1/50	230/1/50
Maximum electric power consumption	1,6	1,8	2,2
Height x Width x Thickness (mm)	330 x 1220 x 960	255 x 1220 x 820	330 x 1220 x 960
Weight (kg)	83	74	89
Supply/return water connections	3/4" - 3/4"	3/4" - 3/4"	3/4" - 3/4"
Condensate drain connection (mm)	20	20	20

\* Outside air temperature 7°; relative humidity 72%. room temperature 20°C; relative humidity 28%, nominal air flow

\*\* Outside air temperature 30°; relative humidity 60%. room temperature 25°C; relative humidity 50%, nominal air flow

\*\*\* Room temperature 25°C; relative humidity 60%, nominal air flow rate; water in 7°C water out 12°C

\*\*\*\* Room temperature 20°C; relative humidity 60%, nominal air flow rate; water in 50°C water out 45°C.

# 08D DEHUMIDIFIERS WITH CMV WALL INSTALLATION WITH HYDRONIC BATTERY FOR HEATING AND COOLING

## VMC CLIMA-V Series

NEW



### 5508V

Controlled mechanical ventilation unit with high efficiency heat recovery unit - vertical installation, with hydronic battery for heating and cooling

Code	Model	Price €	Unit/Box
558 0439	VMC CLIMA-V-50/25		1/1
558 0440	VMC CLIMA-V-60/15		1/1
558 0441	VMC CLIMA-V-90/25		1/1

NEW



### 5508COM

Wi-fi/ Modbus digital remote control for 5508O machines and 5508V. Available colors - black or white.

Compatible with 5508O - 5508V models only

Code	Color	Price €	Unit/Box
957 0217	<input type="checkbox"/> White		1/1
957 0218	<input checked="" type="checkbox"/> Black		1/1

## TECHNICAL FEATURES

	558 0439	558 0440	558 0441
Model	VMC CLIMA-V-50/25	VMC CLIMA-V-60/15	VMC CLIMA-V-90/25
Rated winter recuperator efficiency*	86	84	85,9
Rated summer recuperator efficiency **	84	83	84
Nominal external air flow	258	160	261
Maximum air flow rate	538	620	840
Cooling power hydronic battery output ***	3,32	3,7	5,56
Summer operation water flow	0,7	0,75	0,9
Summer operation pressure drop	17,6	18	20
Heat output ****	3,88	4,5	6,8
Winter operation water flow	0,7	0,75	0,9
Winter operation pressure drop	17,6	18	20
Sound pressure LP at 3 Mt	40,2	40,9	42,1
Power supply	230/1/50	230/1/50	230/1/50
Maximum electric power consumption	1,6	1,8	2,2
Height x Width x Thickness (mm)	1185 x 985 x 740	1085 x 885 x 515	1185 x 985 x 740
Weight (kg)	78	70	81
Supply/return water connections	3/4" - 3/4"	3/4" - 3/4"	3/4" - 3/4"
Condensate drain connection (mm)	20	20	20

\* Outside air temperature 7°; relative humidity 72%. room temperature 20°C; relative humidity 28%, nominal air flow  
 \*\* Outside air temperature 30°; relative humidity 60%. room temperature 25°C; relative humidity 50%, nominal air flow  
 \*\*\* Room temperature 25°C; relative humidity 60%, nominal air flow rate; water in 7°C water out 12°C  
 \*\*\*\* Room temperature 20°C; relative humidity 60%, nominal air flow rate; water in 50°C water out 45°C.





## 5602CON

CMV remote control with temperature and humidity sensor

Code	Size	Price €	Unit/Box
558 0427	-		1/1



## 5503TUB

**HYGIAFLEX THERM** Self-extinguishing insulated flexible pipe made in silver ion aluminum with anti-microbial and anti-mold action. Reaction to fire class M0/M1

Code	Type	Price €/m	Unit/Box (m)
556 0284	∅ 100		10/10
556 0285	∅ 125		10/10
556 0286	∅ 160		10/10
556 0287	∅ 200		10/10
556 0288	∅ 250		10/10
556 0289	∅ 315		10/10



## 5503FAS

Stainless steel hose clip to connect flexible pipe

Code	Type	Price €	Unit/Box
556 0383	∅ 145		1/1
556 0384	∅ 215		1/1
556 0385	∅ 380		1/1



## 5503COL

**COMBO 2-4** Distribution manifold silenced with 2-4 configurable outlet

### DESCRIPTION

- One ∅ 160 mm inlet fitting
- Four ∅ 75/90 mm pre-set for outlet fittings

Code	Size	Price €	Unit/Box
556 0290	300 x 200 x 150 mm		1/1



## 5503COLP

**COMBO 2-6** Distribution manifold silenced with 2-6 configurable outlet

### DESCRIPTION

- One ∅ 160 mm inlet fitting
- 6 pre-sets for ∅ 75/90 mm outlet fittings + panel with 3 ∅ 75/90 mm fittings and 2 lowered 132 x 52 mm fittings

Code	Size	Price €	Unit/Box
556 0293	370 x 240 x 240 mm		1/1



## 5503COLT

**COMBO 2-10** Distribution manifold silenced with 2-10 configurable outlet

### DESCRIPTION

- One ∅ 200 mm inlet fitting,
- 10 pre-sets for ∅ 75/90 mm outlet fittings + panel with 4 ∅ 75/90 mm fittings and 4 lowered 132 x 52 mm fittings

Code	Size	Price €	Unit/Box
556 0291	580 x 240 x 240 mm		1/1



## 5503RCOL

Combo manifold union for COMFOFORM pipe

Code	Type	Price €	Unit/Box
556 0295	∅ 75		1/1
556 0296	∅ 90		1/1



## 5503RCOLP

ComboSlim manifold union for COMFOSLIM pipe

Code	Type	Price €	Unit/Box
556 0297	132 x 52 mm		1/1



## 5503OR

O-ring seal for all gaskets between COMFOFORM pipe, fittings, and distributors

Code	Type	Price €	Unit/Box
556 0299	Ø 75		10/10
556 0300	Ø 90		10/10



## 5503REG

**RAD 2** Constant flow air controller to maintain the design flow rate

Code	Type	Price €	Unit/Box
556 0369	Ø 80/15-50 m <sup>3</sup> /h		1/1
556 0370	Ø 100/15-50 m <sup>3</sup> /h		1/1
556 0371	Ø 100/50-100 m <sup>3</sup> /h		1/1
556 0372	Ø 125/15-50 m <sup>3</sup> /h		1/1
556 0373	Ø 125/50-100 m <sup>3</sup> /h		1/1
556 0374	Ø 160/15-50 m <sup>3</sup> /h		1/1
556 0375	Ø 160/50-100 m <sup>3</sup> /h		1/1
556 0376	Ø 160/100-180 m <sup>3</sup> /h		1/1
556 0377	Ø 160/180-300 m <sup>3</sup> /h		1/1
556 0378	Ø 200/15-50 m <sup>3</sup> /h		1/1
556 0379	Ø 200/50-100 m <sup>3</sup> /h		1/1
556 0380	Ø 200/100-180 m <sup>3</sup> /h		1/1
556 0381	Ø 200/180-300 m <sup>3</sup> /h		1/1
556 0382	Ø 200/300-500 m <sup>3</sup> /h		1/1



## 5503TAP

Blind stopper for COMFOFORM pipe

Code	Type	Price €	Unit/Box
556 0302	Ø 75		5/5
556 0303	Ø 90		5/5



## 5503TCOMPU

**COMFOFORM PURO** Flexible antistatic circular pipe with antibacterial treatment for floor, ceiling liner, and wall mounted distribution systems, highly flexible, with double layer wrinkled on the outside and smooth on the inside, entirely made in PE

Code	Type	Price €/m	Unit/Box (m)
556 0309	Ø 75		50/50
556 0310	Ø 90		50/50



## 5503BOB

**COMFOFORM ISO** Insulating coil for COMFOFORM circular pipe.

Code	Type	Price €/m	Unit/Box (m)
556 0311	Ø 75		15/15
556 0312	Ø 90		15/15



## 5503GIU

Connection joint for COMFOFORM pipe

Code	Type	Price €	Unit/Box
556 0314	Ø 75		1/1
556 0315	Ø 90		1/1



## 5503CUR

90° curve for COMFOFORM pipe

Code	Type	Price €	Unit/Box
556 0316	90° - Ø 75		1/1
556 0317	90° - Ø 90		1/1







## 5503BOC

PG Grid-holder built-in terminal, pre-set for filter, with ceiling, wall, and ceiling liner installation.

### VERSIONS

- **PG1 MC:** single side fitting on the short side  $\varnothing$  75/90 mm (236 x 135 x 115)
- **PG1 P-L:** single back fitting  $\varnothing$  75/90 mm single side fitting on long side  $\varnothing$  75 mm (236 x 135 x 90)
- **PG1 L90:** single side fitting on the long side  $\varnothing$  90 mm (236 x 135 x 115)
- **PG2 P-L:** double back fitting  $\varnothing$  75/90 mm double side fitting on long side  $\varnothing$  75 mm (410 x 135 x 90)
- **PG2 L90:** double side fitting on the long side  $\varnothing$  90 mm (410 x 135 x 115)
- **PG3 P-L:** single back side lowered fitting 132 x 52
- **PG4 P-L:** double back side lowered fitting 132 x 52

**i** To be coupled with grid 5503GRI and filter 5503FIL

Code	Model	Price €	Unit/Box
556 0318	PG1 MC		1/1
556 0319	PG1 P-L		1/1
556 0320	PG1 L90		1/1
556 0323	PG2 P-L		1/1
556 0325	PG2 L90		1/1
556 0321	PG3 P-L		1/1
556 0324	PG4 P-L		1/1



## 5503GRI

TAMIGI Steel perforated grid painted white for PG built-in terminal

**i** Accessory for item 5503BOC

Code	Type	Price €	Unit/Box
556 0327	-		1/1
556 0326	-		1/1
556 0328	-		1/1

Suitable with PG art. 5503BOC model PG1 MC

Suitable with PG art. 5503BOC models PG1 P-L/PG1 L90/PG3 P-L

Suitable with PG art. 5503BOC models PG2 P-L/PG2 L90/PG4 P-L



## 5503FIL

Filter for PG built-in terminal

**i** Accessory for art. 5503BOC

Code	Type	Price €	Unit/Box
556 0329	-		5/5
556 0330	-		5/5

Suitable with PG terminal 5503BOC models PG1 MC/PG1 P-L/PG1 L90/PG3 P-L

Suitable with PG terminal 5503BOC models PG2 P-L/PG2 L90/PG4 P-L



## 5503TSLPU

COMFOSLIM PURO Flexible lowered pipe, with resistant to crush, antistatic and antibacterial treatment, for floor, ceiling lining and wall distribution systems. Made with a double layer wrinkled on the outside and smooth on the inside, entirely made in PE. Sole exclusive connection joint to easily connect the pipe to all the fittings. The coupling can also be fixed with specific rings.

Code	Type	Price €	Unit/Box (m)
556 0331	132 x 52 mm		20/20
556 0332	132 x 52 mm		3 m x 12 p =36

Provided in bars



## 5503BOBSL

COMFOSLIM ISO Insulating coil for COMFOSLIM circular pipe

Code	Type	Price €/m	Unit/Box (m)
556 0334	132 x 52 mm		10/10



**5503RCOLSL**  
Combo manifold union with COMFOSLIM pipe

Code	Type	Price €	Unit/Box
556 0333	∅ 90 - 132 x 52 mm		1/1



**5503ROVSL**  
Reverse 180° fitting to be used to reverse the flat side of COMFOSLIM pipe in walls climbs and connect them to the terminal

Code	Type	Price €	Unit/Box
556 0339	180° - 132 x 52 mm		1/1



**5503GIUSL**  
Connection joint with double O-ring seal for COMFOSLIM pipe

Code	Type	Price €	Unit/Box
556 0335	132 x 52 mm		1/1



**5503RAC**  
Straight fitting for COMFOSLIM pipe and COMFOFORM circular pipe

Code	Type	Price €	Unit/Box
556 0341	∅ 75 - 132 x 52 mm		1/1
556 0342	∅ 90 - 132 x 52 mm		1/1



**5503TAPSL**  
Blind stopper for COMFOSLIM pipe

Code	Type	Price €	Unit/Box
556 0336	132 x 52 mm		1/1



**5503GRIAIR**  
**AIR PURA** Finned grid finished with natural anodized aluminum, including mesh and painted upon request

Code	Type	Price €	Unit/Box
556 0344	300 x 150 mm		1/1
556 0345	400 x 200 mm		1/1
556 0346	500 x 300 mm		1/1



**5503CURVSL**  
90° vertical curve for COMFOSLIM pipe

Code	Type	Price €	Unit/Box
556 0337	90° Vert. - 132 x 52 mm		1/1



**5503PLE**  
**PGS20** Plenum in galvanized sheet for PURA grid with circular back fitting

Code	Type	Price €	Unit/Box
556 0347	300 x 150 mm/ ∅ 148		1/1
556 0348	400 x 200 mm/ ∅ 198		1/1
556 0349	500 x 300 mm/ ∅ 248		1/1



**5503CUROSL**  
90° horizontal curve for COMFOSLIM pipe

Code	Type	Price €	Unit/Box
556 0338	90° Horiz. - 132 x 52 mm		1/1





## 5503GPT

PURA TONDA Grid for expulsion/inlet of external air including fitting in galvanized sheet

Code	Type	Price €	Unit/Box
556 0350	Ø 160 - Ø 125		1/1
556 0351	Ø 200 - Ø 160		1/1
556 0352	Ø 250 - Ø 200		1/1



## 5503VAL

Inflow/extraction valve for small air flow rates with adjustable central disk, made in plastic, resistant to hard environments, including fixing sleeve

Code	Type	Price €	Unit/Box
556 0361	Ø 100 + Sleeve		1/1
556 0362	Ø125 + Sleeve		1/1
556 0363	Ø 160 + Sleeve		1/1
556 0364	Ø 200 + Sleeve		1/1



## 5503DIFR

AERYS Inflow/intake circular diffuser with flow rate self-adjusting RAD controller

Code	Type	Price €	Unit/Box
556 0366	Ø 125		1/1
556 0393	Ø 160		1/1
556 0394	Ø 200		1/1



## 5503DIF

BOREA Inflow/intake circular diffuser

Code	Type	Price €	Unit/Box
556 0367	Ø 80		1/1
556 0368	Ø 125		1/1



## 5503SIL

SC VMC Circular silencer with galvanized steel external shell, 45 to 65 mm. thick acoustic insulation, coated in perforated sheet

Code	Type	Price €	Unit/Box
556 0353	Ø 125 L=600 mm		1/1
556 0354	Ø 160 L=600 mm		1/1
556 0355	Ø 200 L=600 mm		1/1
556 0356	Ø 250 L=600 mm		1/1
556 0357	Ø 125 L=900 mm		1/1
556 0358	Ø 160 L=900 mm		1/1
556 0359	Ø 200 L=900 mm		1/1
556 0360	Ø 250 L=900 mm		1/1







## PRODUCTS QUALITY

TIEMME RACCORDERIE S.p.A.  
manufacturer of complete heating, sanitary and gas systems  
situated in Castegnato (Brescia) Via Cavallera, 6/A  
as per Ministerial Decree 37/08 "Plants Installation"  
and as per 10/91 law

### DECLARES

that all the products distributed to the customers  
are designed and manufactured in compliance with technical regulation  
and quality criteria required by International Standards EN ISO 9000.

The quality of TIEMME products  
has been awarded with ISO 9001 certification  
acknowledging the Company's commitment  
to the development, production and marketing  
of its goods.

***The Legal Representative***

FACSIMILE COPY

The original document and the entire text of the above-mentioned regulations are stored in the legal office of  
TIEMME RACCORDERIE S.p.A. Via Cavallera 6/A - 25045 - Castegnato (Bs)

The products manufactured by Tiemme Raccorderie S.p.A. (hereinafter referred to as "Company") are guaranteed for 2 years from the date of shipment from its premises. This warranty is additional to and does not affect the buyer's rights under the European Directive 99/44/CE and its national implementing decree, except where otherwise specified.

This warranty does not cover the failure or damage caused by:

- Transport not carried out by the Company.
- No compliance with instructions and warnings provided by the manufacturer and reported on manuals, and instructions and/or product catalogues.
- No compliance with law and/or regulations.
- Absence or lack of maintenance, neglect, inability to use, tampering.
- Improper installation and/or anomalies of any nature in the supply of hydraulic, electrical, fuel delivery and/or exhaust systems.
- Inadequate water treatments, disinfecting treatments improperly carried out.
- Corrosion due to the aggressive nature of water or condensation.
- Frost, stray currents, and/or harmful effects of lightning and storms.
- Preventive replacements.
- Causes of force majeure beyond the control of the manufacturing Company.

Any defect in materials or hidden faults as well as mistakes or differences in dimensions exceeding normal manufacturing tolerances will commit the Company to the replacement of defective parts only.

Any return of non-conforming goods will be accepted only with prior written authorization ("Return Authorization") by the Company's Sale Manager.

In any case the returned goods shall have to reach the Company's warehouse freight paid, otherwise the goods will be rejected and returned to the sender.

Any return of non-compliant material must be agreed in advance with the Company's Sale Director. Transport costs will be borne by the customer.

The insurance cover has the duration of 10 years from the date of shipment from the Company's premises, as contemplated in the Decree 24-05-1988 n°224.

Only in the case of the implementation of non-conforming products manufactured by the Company and as a result, accidental damages to person or things, the Company will require their insurance agency to proceed according to its policy. The claim has to be placed within 10 days of the event, otherwise a non-compensation penalty will apply. A specific questionnaire including all the accident details, relevant documentation, and samples of the faulty articles which are necessary to complete the compensation file must be duly filled within 30 days. No refund will be granted before the Company has verified the causes of the complaint.

Should laboratory tests be necessary, the costs incurred whilst checking and defining the non-conformity of a claim or return or damage will be charged to the customer if the fault cannot be attributed to the Company.

Installers are to carry out and document plant tests in compliance with international regulations in force in Italy as prescribed by the Ministerial Decree 37/08 and UNI 9182 standards.

### ORDERS

All orders are placed as reservation and do not bind our Company to delivery, not even partially. Orders will be accepted and despatched only if in an amount exceeding 700 €.

### PRICES

Unless otherwise agreed in writing the prices in force at the time of delivery or shipment shall apply.

Prices are meant for goods delivered EX WORKS.

### SHIPMENTS

Goods are usually shipped freight collect, unless otherwise agreed. Goods travel at buyer's risk even if sold free of carriage.

### PAYMENTS

Payment conditions are those stated in the invoice and are binding. Upon the expiration date of agreed deadlines, without any notice, interests on arrears calculated according to the average bank rate applied to the date of expiry shall be counted.

Any draft or payment fees will be at full client's charge.

### CLAIMS

No claim will be accepted after 5 days upon goods receipt. Claims shall be submitted in writing and addressed to our headquarters.

### RETURNED GOODS

No returned goods will be accepted without our previous authorization. The authorization must be issued in writing and goods are, in any case, returned carriage paid.

### SUSPENDED ORDERS AND FORCE MAJEURE

If the buyer does not comply, even partially with our terms of sale, our company can suspend further deliveries.

Our company is exempt from any obligation arising from the sale agreement in case of force majeure.

### CHANGES

**Our company reserves the right to make, without notice, any changes that are technically necessary at any time and for any reason.**

Images included in this catalogue are shown for information purposes only and they do not bind the Company which reserves the right to make changes without prior notification.

### COURT OF JURISDICTION

In the event of a dispute, the competent authority is the Court of Brescia.

## INTEGRATED COMPONENTS AND SYSTEMS FOR PLUMBING PLANTS



HYDRO COMPONENTS



CENTRAL HEATING - METERING



RADIANT SYSTEMS



FAUCETS







**TIEMME RACCORDERIE S.p.A.**  
Via Cavallera, n. 6/A- 25045 Castegnato (BS)- Italy  
Tel. +39 030 2142211- Fax +39 030 2142206  
info@tiemme.com

Customer Service Fax +39 030 2142254  
customerservice@tiemme.com

[www.tiemme.com](http://www.tiemme.com)

